

## Peak Emission Wavelength: 385nm

The MTSM385UV-D5120 is a ultraviolet light emitting diode with peak emission wavelength of 385nm. The High power UV LED is designed for high current operation and high power output operations. It incorporates state of the art SMD design and low thermal resistant material.

### FEATURES

- > Super high power output
- > Low thermal resistance
- > SMT solderable
- > Designed for high current operation

### APPLICATIONS

- > UV Curing
- > Printing
- > Coating
- > Counterfeit Detection / Security

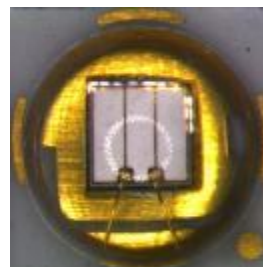

## Absolute Maximum Ratings (Ta=25°C)



ITEMS	SYMBOL	RATINGS	UNIT
Forward Current	If	700	mA
Junction Temperature	Tj	90	°C
Operating Temperature	Topr	-10 to +85	°C
Storage Temperature	Tstg	-40 to +100	°C

Note: Also available on PCB - Star Board      MTSM385UV-D5120S

## Electrical & Optical Characteristics (Ta = 25°C, RH=30%)

ITEMS	SYMBOL	CONDITION	TYPICAL	UNIT
Peak Wavelength [1]	$\lambda_p$	IF=500mA	385	nm
Radiant Flux [2]	$\Phi_e$ [3]	IF=500mA	1100	mW
Forward Voltage [4]	Vf	IF=500mA	3.6	V
FWHM	$\Delta\lambda$	IF=500mA	12	nm
Viewing Angle	$2\Theta_{1/2}$	IF=500mA	120	deg
Thermal Resistance	R $\Theta_j$ -b [5]	--	8.9	°C/W

### Notes:

- [1] Peak wavelength Measurement tolerance is  $\pm 3$ nm
- [2] Radiant Flux Measurement tolerance is  $\pm 10\%$
- [3]  $\Phi_e$  is the Total Radiant Flux as measured with a radiometer with an integrated sphere
- [4] Forward voltage measurement tolerance is  $\pm 3\%$
- [5] R $\Theta_j$ -b is the thermal resistance between chip junction to PCB board bottom.

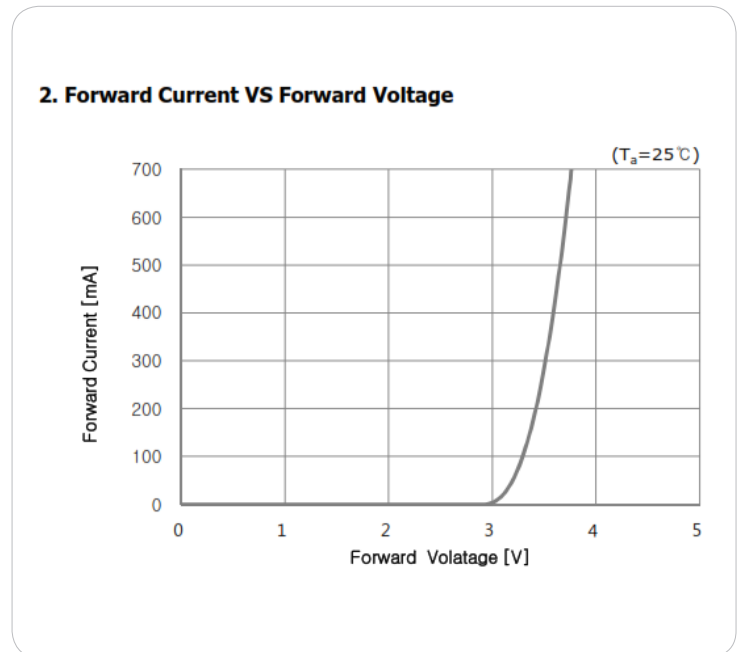
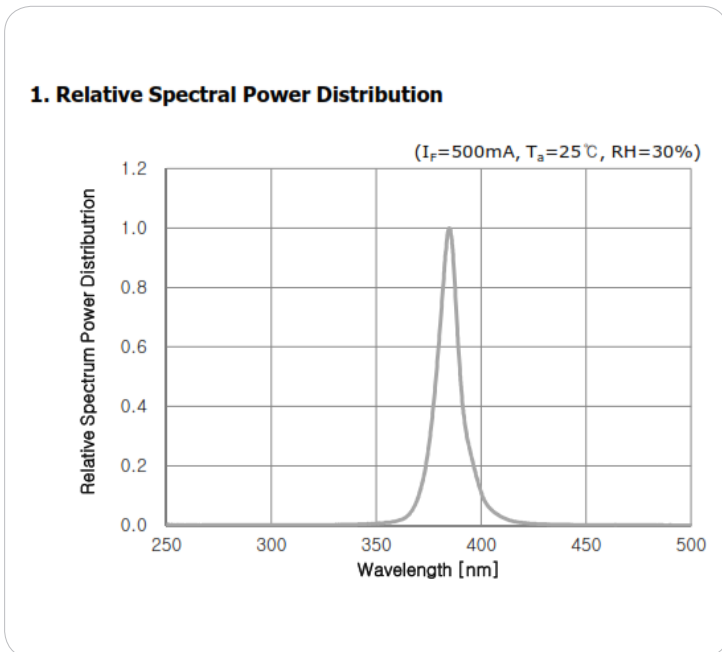
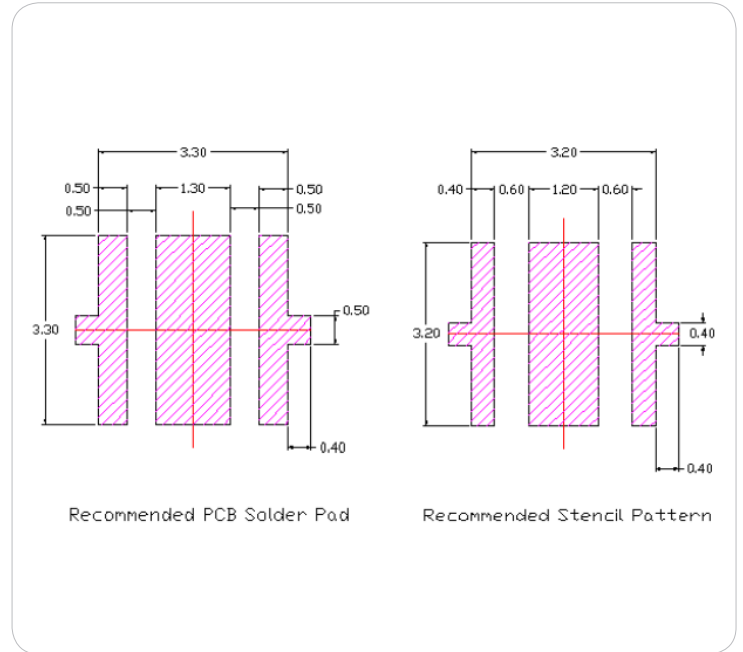
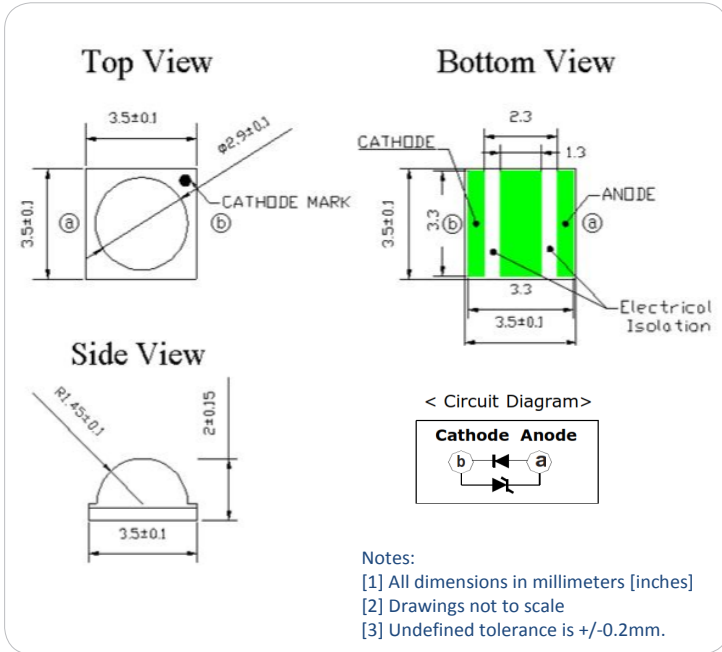

$T_a = 25\text{ }^\circ\text{C}$ , RH=30%

**3. Relative Radiant Flux VS Forward Current**

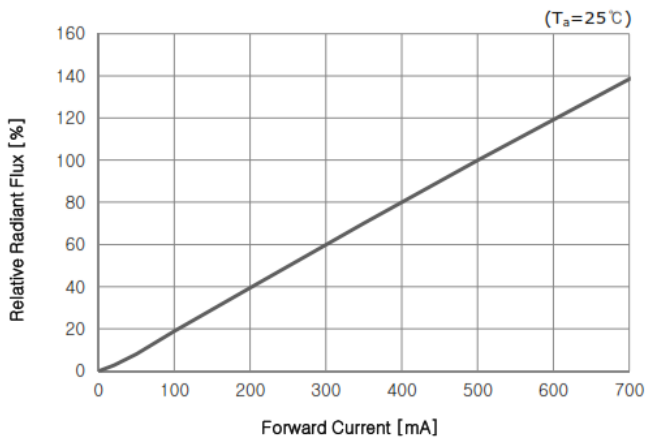

**4. Peak Wavelength VS Forward Current**

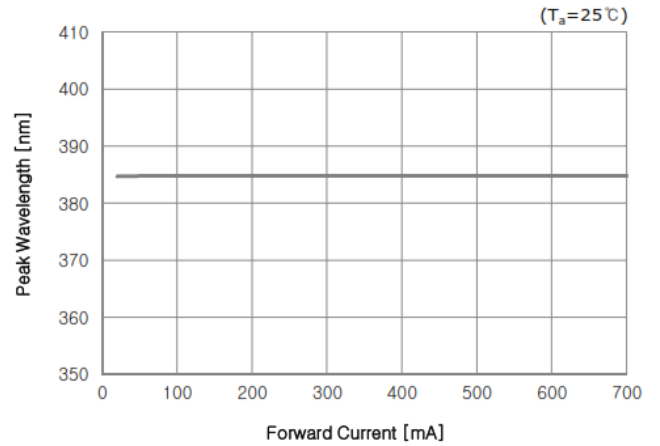

**5. Relative Radiant Flux VS Ambient Temperature**

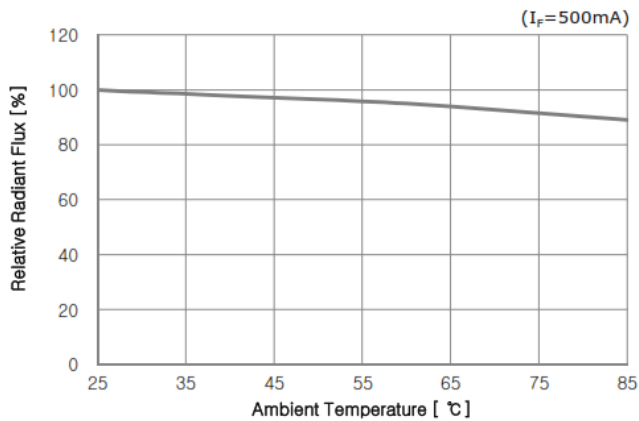

**6. Peak Wavelength VS Ambient Temperature**

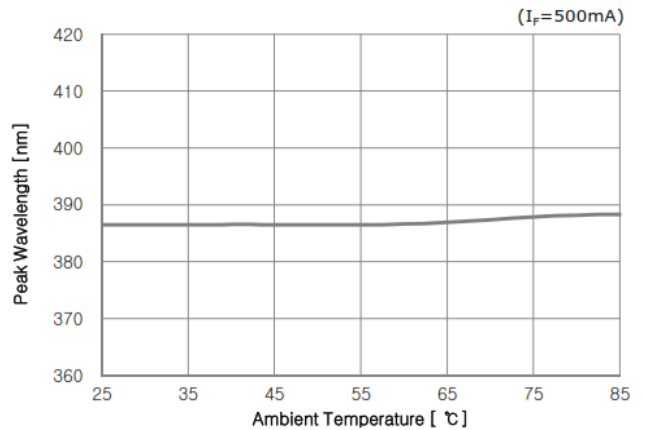

**7. Forward Voltage VS Ambient Temperature**

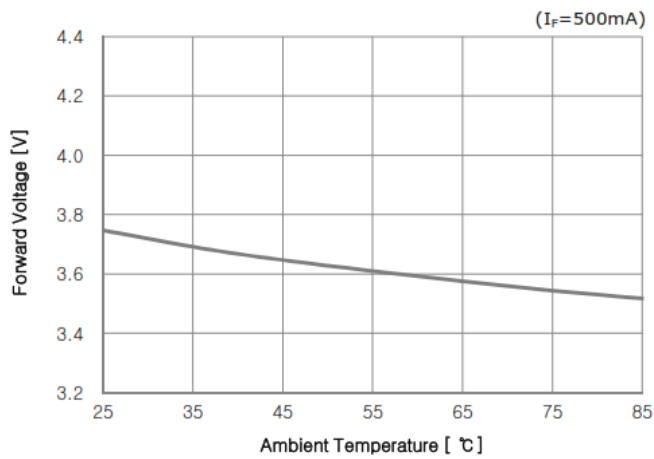

**8. Radiation pattern**

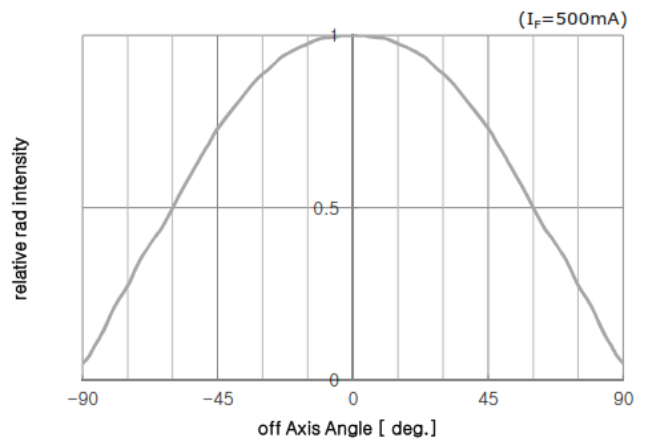

**9. Allowable Forward Current VS Ambient Temperature**

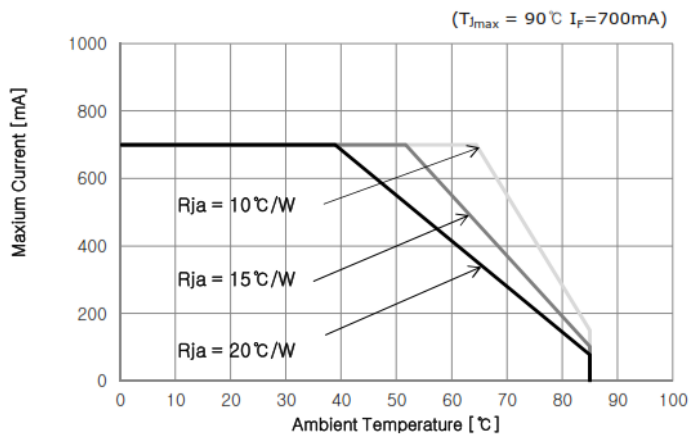

## Reflow Soldering Profile

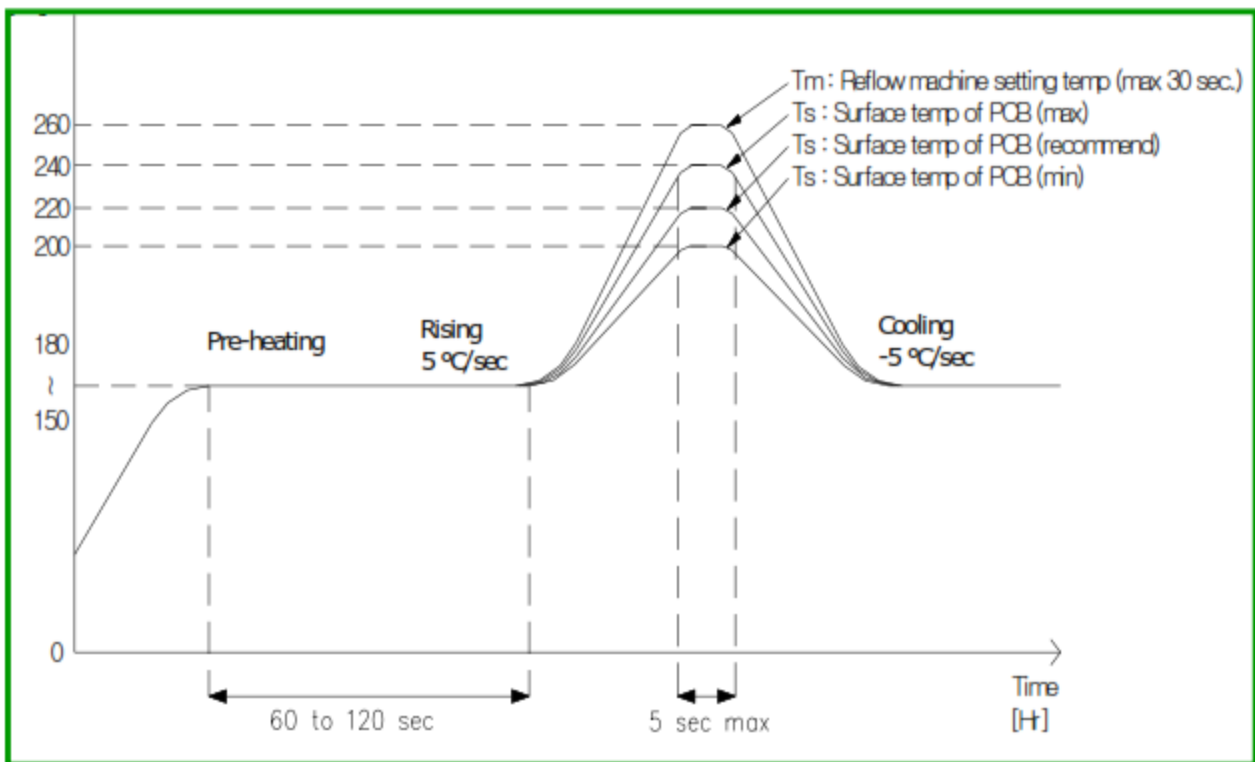

### \* Caution

1. Reflow soldering should not be done more than one time.
2. Repairs should not be done after the LEDs have been soldered. When repair is unavoidable, suitable tools must be used.
3. Die slug is to be soldered.
4. When soldering, do not put stress on the LEDs during heating.
5. After soldering, do not warp the circuit board.
6. Recommend to use a convection type reflow machine with 7 ~ 8 zones.

## 1. Relative Spectral Power Distribution

Test Item	Standard Test Method	Test Condition	Duration /cycle	Number of damage
<b>High Temp. Operational Life</b>	Internal Reference	Ta=85℃, IF=500mA	1000hrs	0/5
<b>Room Temp. Operational Life</b>	Internal Reference	Ta=25℃, IF=500mA	1000hrs	0/5
<b>High Temp. Storage</b>	EIAJ ED-4701	Ta = 100℃	1000hrs	0/22
<b>Thermal shock</b>	EIAJ ED-4701	Ta max=120℃, Ta min=-40℃ 30min dwell/transfer time : 10sec, 1 cycle=1hr	200 cycles	0/22
<b>Resistance to Soldering</b>	EIAJ ED-4701	Temp=260±5℃, Time : 10±1 sec	1 time	0/10
<b>ESD</b>	EIAJ ED-4701	R=1.5kΩ, C=100pF Voltage level=2kV	3 times Negative /positive	0/22

## 2. Failure Criteria

Parameter	Symbol	Test Conditions	Max. or Min. allowable shift value
<b>Forward Voltage</b>	$V_F$	IF=500mA	Max. Initial measurement x 1.2
<b>Radiant Flux</b>	$\Phi_e$	IF=500mA	Min. Initial measurement x 0.7

Notes :

1. The value is measured after the test sample is cooled down to the room temperature.

## Precaution for use

### 1) Storage

- To avoid moisture penetration, we recommend storing UV LEDs in a dry box with a desiccant. The recommended temperature and Relative humidity are between 5°C and 30°C and below 50% respectively.
- LEDs must be stored properly to maintain the device. If the LEDs are stored for 3 months or more after being shipped from SVC, a sealed container with a nitrogen atmosphere should be used for storage.
- Replace the remained LEDs into the moisture-proof bag and reseal the bag after work to avoid those LEDs being exposed to moisture. Prolonged exposure to moisture can adversely affect the proper functioning of the LEDs.
- If the package has been opened more than 4 week(MSL\_2a) or the color of the desiccant changes, components should be dried for 10-12hr at 60±5°C
- The conditions of resealing are as follows
  - Temperature is 5 to 40°C and Relative humidity is less than 30%

### 2) Handling Precautions

- VOCs (Volatile organic compounds) emitted from materials used in the construction of fixtures can penetrate silicone encapsulants of LEDs and discolor them when exposed to heat and photonic energy. The result can be a significant loss of light output from the fixture. Knowledge of the properties of the materials selected to be used in the construction of fixtures can help prevent these issues.
- In case of attaching LEDs, do not use adhesives that outgas organic vapor.
- Soldering should be done as soon as possible after opening the moisture-proof bag.
- Do not rapidly cool device after soldering.
- Do not apply mechanical force or excess vibration during the cooling process to normal temperature after soldering.
- Components should not be mounted on warped (non coplanar) portion of PCB.
- The UV LED is encapsulated with a silicone resin for the highest flux efficiency. So it needs to be handled carefully as below
  - Avoid touching silicone resin parts especially with sharp tools such as pincettes(Tweezers)

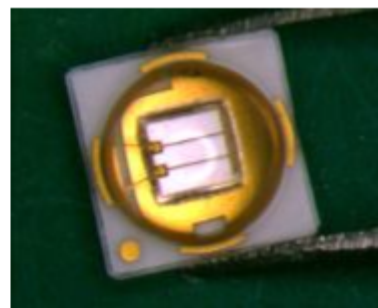

- Avoid leaving fingerprints on silicone resin parts.
- Silicone resin will attract dust so use covered containers for storage.
- When populating boards in SMT production, there are basically no restrictions regarding the form of the pick and place nozzle, except that excessive mechanical pressure on the surface of the resin must be prevented.
- It is not recommend to cover the silicone resin of the LEDs with other resin (epoxy, urethane, etc).

3) Safety for eyes and skin

- The Products emit high intensity ultraviolet light which can make your eyes and skin harmful, So do not look directly into the UV light and wear protective equipment during operation.

4) Cleaning

- This device is not allowed to be used in any type of fluid such as water, oil, organic solvent , etc.

5) Others

- The appearance and specifications of the product may be modified for improvement without notice.
- When the LEDs are in operation the maximum current should be decided after measuring the package temperature.
- The driving circuit must be designed to allow forward voltage only when it is ON or OFF. If the reverse voltage is applied to LED, migration can be generated resulting in LED damage.
- Do not handle this product with acid or sulfur material in sealed space.

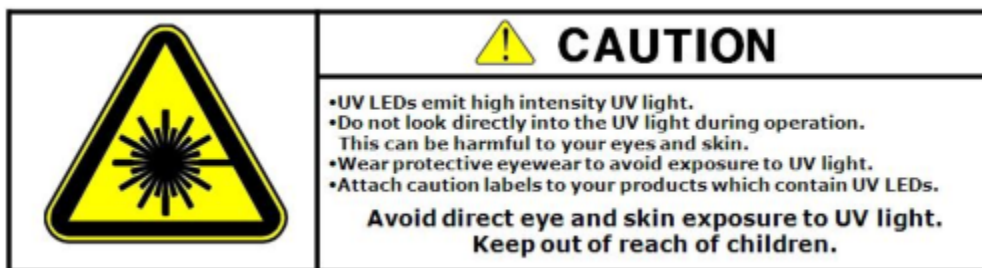



## Reel Packaging

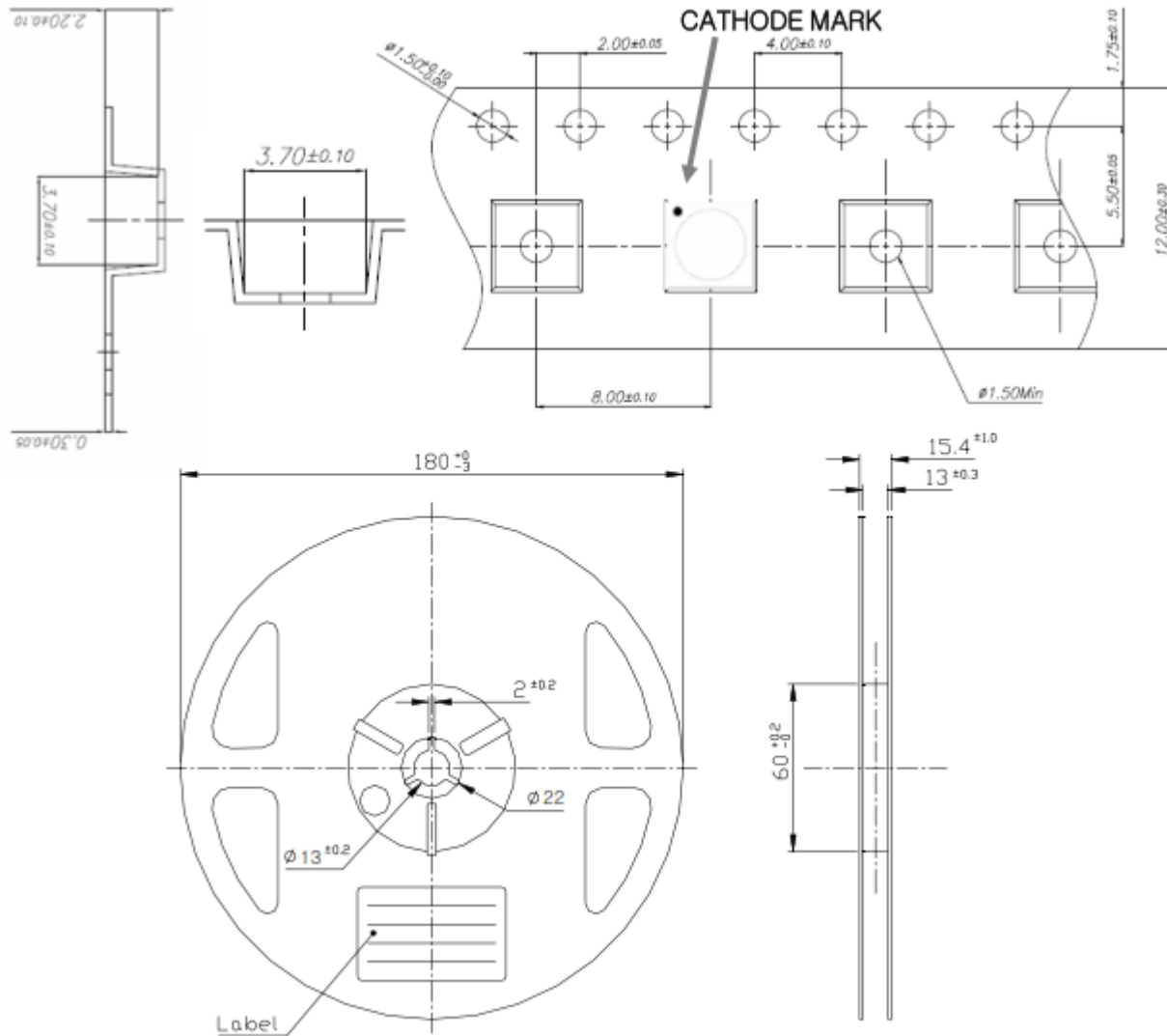

## X-ON Electronics

Largest Supplier of Electrical and Electronic Components

*Click to view similar products for [High Power LEDs - Single Colour](#) category:*

*Click to view products by [Marktech](#) manufacturer:*

Other Similar products are found below :

[L135-L567003500000](#) [L1CU-VLT1000000000](#) [KY DDLM31.23-8F5H-36-C4U4-140-R18](#) [KR DDLM31.23-5G7H-25-C4U4-140-R18](#) [KT DDLM31.13-6H7J-36-W4A4-140-R18](#) [KS DDLM31.23-8E6G-68-C4U4-140-R18](#) [KB DDLM31.13-6D7E-25-24A4-140-R18](#) [GT CS8PM1.13-LSLU-26-1-350-B-R18](#) [GR CS8PM1.23-KQKS-1](#) [GH CS8PM1.24-4T2U-1-0-350-R33](#) [GT CSHPM1.13-LSLU-26-1-350-B-R18](#) [AA2810AVBS/D](#) [KT CSLNM1.13-MXMZ-34-0](#) [KT DELQS1.12-TIVH-36-S446-10-S](#) [LZ4-V0UB0R-00U4](#) [LZ4-00UB0R-00U4](#) [XPEBRY-L1-0000-00S02](#) [XQEAPA-00-0000-000000701](#) [XQEBLU-00-0000-000000Z02](#) [SPHWH2L3D30ED4V0H3](#) [XQEBLU-00-0000-000000202](#) [LUWCQ7P-LPLR-5E8G-1-K](#) [ASMT-QHBD-AFH0E](#) [ASMT-AA00-ARS00](#) [ASMT-JR30-ARS01](#) [ASMT-QABD-AEF0E](#) [LZ1-00R100-0000](#) [GY CS8PM1.23-KQKS-36](#) [GH CSSPM1.24-4T2U-1](#) [GDCSSPM1.14-UNUO-W4-1](#) [GYCSHPM1.23-KPKR-36](#) [KY DMLQ31.23-HYKX-46-J3T](#) [KY DMLN31.23-GYJX-46-J3T3](#) [L1SP-DRD0002000000](#) [L1SP-LME0002000000](#) [LHUV-0405-A065](#) [LTPL-C034UVH410](#) [XPGDRY-L1-0000-00601-SB01](#) [XQEGRN-H0-0000-000000901](#) [XPEEPR-L1-0000-00B01](#) [XPEEPR-L1-0000-00A01](#) [XPGDRY-L1-0000-00501](#) [XPGDRY-L1-0000-00401](#) [XQEEPR-00-0000-000000901](#) [XQEEPR-00-0000-000000A01](#) [15335340AA350](#) [XPCRDO-L1-R250-00701](#) [XPEBGR-L1-0000-00D03](#) [XPEGRN-L1-0000-00F02](#) [XRCRDO-L1-R250-00K03](#)