

## MINIOVEN 04 S - BGA-REBALLER

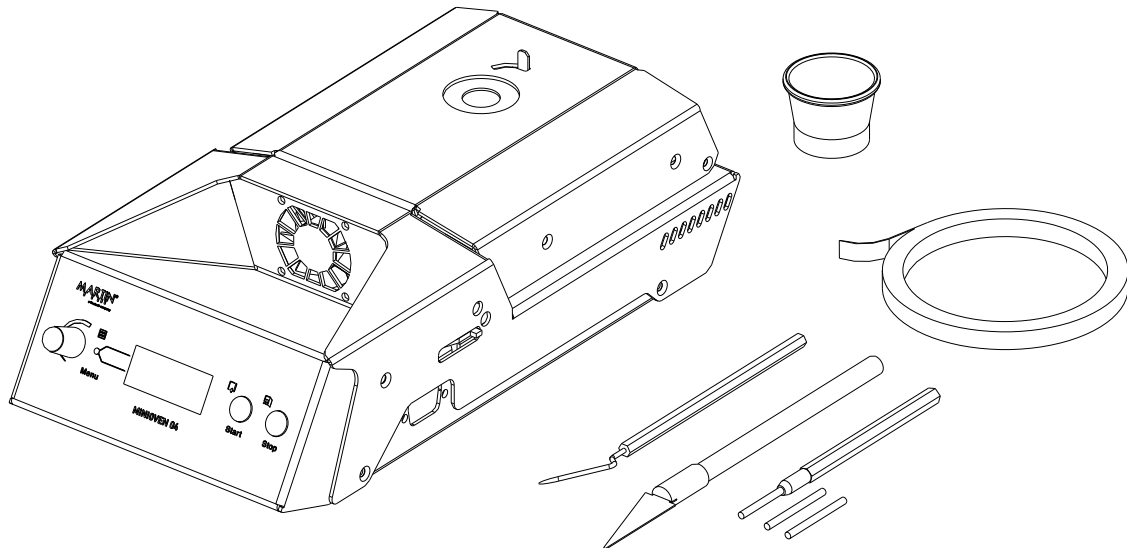

### HB00.0033      MINIOVEN 04 S

The desktop MINIOVEN 04 S is designed for Reballing area array devices such as BGAs and CSPs along with Prebumping leadless components including QFNs and other surface mount devices. Additionally the Mini-Oven is used to Reflow small form factor assemblies and other thermal applications.

The Mini-Oven 04 is convection dominant, it provides extremely uniform heating necessary for simultaneous reflow of large area array components. The integrated processor provides closed-loop thermal control via feedback from a strategically positioned process thermocouple. Up to 99 different heating recipes / profiles can be taught and stored.

The Mini-Oven is also available with optional Process Gas Inlet. Use of a nitrogen atmosphere during reflow promotes improved wetting by displacing oxygen and minimizing further oxidation. Reballing and Prebumping tooling is readily available for most standard SMD components.

#### Features

- MINIOVEN 04S Unit
- Cutter Knife
- SMD Hook
- Cleaning pen with two spare inserts
- Kapton Tape
- Optical magnifier 5x

#### Technical Data

System power consumption:	550 VA
Power heater:	500 W, 4 x IR-Lamps
Size heater:	105 x 130 mm <sup>2</sup>
Rec. max. component Size:	55 x 55 x 4 mm <sup>3</sup>
Mains:	1 Phase, 230 VAC
System dimensions:	150 x 300 x 85 mm <sup>3</sup>

# MINIOVEN 04 S - BGA-REBALLER

## Features

HB50.0004

Basic Equipment for Mini Oven 04 Set  
clean pen, hook, tape, cutter, magnifier



1 price

Fiber brush clean  
pen with three spare

Kapton Tape  
19mmx5m

## Application Sets

LW50.9001

**Reball-04 Set eco Standard**

1 set

LW40.0236

Reballing Fixture BGA 45\*45mm for MO-04  
4 downholder clips



Part of set

LW40.0500

Reballing Frame Set BGA  
7 pieces (15, 23, 27, 31, 35, 37.5, 40)

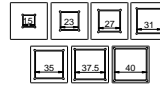

Part of set

LW40.0543

Reballing Mask BGA 45\*45mm  
n=1225 / Pitch=1,27 / Grid=35\*35 / Ball=0,762

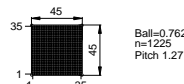

Part of set

LW40.0686

Reballing Mask BGA 45\*45mm  
n=1156 / Pitch=1,27 / Grid=34\*34 / Ball=0,762

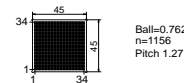

Part of set

LW40.0688

Reballing Mask BGA 45\*45mm  
n=1936 / Pitch=1,00 / Grid=44\*44 / Ball=0,6

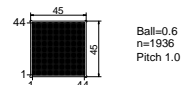

Part of set

LW40.0687

Reballing Mask BGA 45\*45mm  
n=1849 / Pitch=1,00 / Grid=43\*43 / Ball=0,6

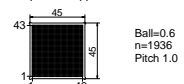

Part of set

SF29.0002

**Prebump-04 Set QFN**

1 set

HB50.0005

Tooling and Fixture for QFN Prebumping  
printer, holder, squeegee, tweezers

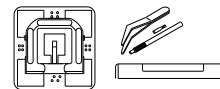

Part of set

LWxx.xx11

Prebumping Mask + Frame QFN  
Type of standard QFN mask on request

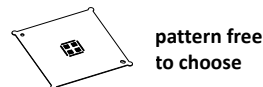

Part of set

## Optional Extras

LW40.0236

Reballing Fixture BGA 45\*45mm for MO-04  
4 downholder clips

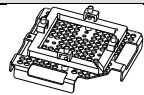

1 piece

LW40.0448

Reballing Frame BGA 15\*15mm eco  
for mini oven, fixture 45\*45mm



1 piece

LW40.0446

Reballing Frame BGA 23\*23mm eco  
for mini oven, fixture 45\*45mm



1 piece

LW40.0442

Reballing Frame BGA 27\*27mm eco  
for mini oven, fixture 45\*45mm



1 piece

LW40.0450









Reballing Frame BGA 31\*31mm eco  
for mini oven, fixture 45\*45mm

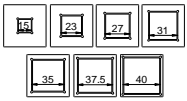
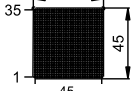
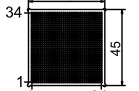
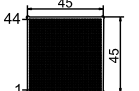
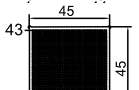
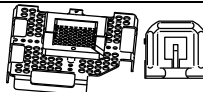
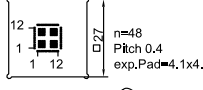
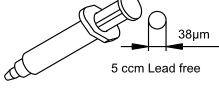

1 piece

# MINIOVEN 04 S - BGA-REBALLER

## Optional Extras

LW40.0438	Reballing Frame BGA 35*35mm eco for mini oven, fixture 45*45mm		1 piece
LW40.0432	Reballing Frame BGA 37.5*37.5mm eco for mini oven, fixture 45*45mm		1 piece
LW40.0435	Reballing Frame BGA 40*40mm eco for mini oven, fixture 45*45mm		1 piece
LW40.0500	Reballing Frame set BGA eco 7 pieces (15, 23, 27, 31, 35, 37.5, 40)		1 piece
LW40.0543	Reballing Mask BGA 45*45mm n=1225 / pitch=1.27 / grid=35*35 / ball=0.762		1 piece
LW40.0686	Reballing Mask BGA 45*45mm n=1156 / pitch=1.27 / grid=34*34 / ball=0.762		1 piece
LW40.0688	Reballing Mask BGA 45*45mm n=1936 / pitch=1.00 / grid=44*44 / ball=0.60		1 piece
LW40.0687	Reballing Mask BGA 45*45mm n=1849 / pitch=1.00 / grid=43*43 / ball=0.60		1 piece
A wide selection of re-balling and paste printing masks / stencils are on stock. Contact MARTIN for detailed request.			
LW40.0252	Prebump Fixture with Printer QFN 27*27mm for MO 04		1 piece
LW50.0204	Prebumping Mask+Frame QFN 6.0*6.0mm 27*27mm n=48 / pitch=0.40 / pads=(12+12)2		1 piece
VD90.0230	Solder Paste print 5ccm finepitch 4 lead free Sn96.5Ag3Cu, ROLO, 20-38µm		1 piece
HT00.0119	Flux Creme lead free 18g 0506 MA, no clean, RELO, with Brush		1 piece
HT00.0020	Brush for Flux Creme		1 piece
HT00.0019	Clean Pen for pads and IR Glass with 3 spare erasers		1 piece
HT00.0062	Kapton-Tape 19mm*5,5m		1 piece
HT00.0013	Sensor for Temperature Measurements K Type, D 0.1mm		1 piece

## **X-ON Electronics**

Largest Supplier of Electrical and Electronic Components

*Click to view similar products for [Martin SMT manufacturer](#):*

Other Similar products are found below :

[HT00.0013](#) [HT00.0019](#) [HT00.0119](#) [VD90.5009](#) [VD90.5006](#)