

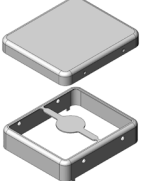

MS293-10*

DRAWN EMI/RFI SHIELD DATA-SHEET

*OPTIONAL SHIELD CONFIGURATIONS

MS SHIELD	MS SET PN.	MS ITEM PN.	DESCRIPTION	RAW MATERIAL
	MS293-10	MS293-10C	TWO-PIECE SHIELD COVER	TIN STEEL*
		MS293-10F	TWO-PIECE SHIELD FRAME	
	MS293-10-NS	MS293-10C-NS	TWO-PIECE SHIELD COVER	NICKEL SILVER**
		MS293-10F-NS	TWO-PIECE SHIELD FRAME	
		MS293-10S	ONE-PIECE SHIELD	TIN STEEL*
		MS293-10S-NS	ONE-PIECE SHIELD	NICKEL SILVER**

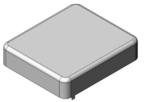
* TIN-PLATED STEEL: CRS ELECTROLYTIC TINPLATE

** NICKEL SILVER: UNS C77000 / UNS C73500



MS PN:

DESCRIPTION:

MATERIAL:

© MASACH TECH LTD.
22 HAGANAN, MODIIN 7169513 ISRAEL
T: (+972) 8-9754681 / F: (+972) 8-9754682
info@masach.com / www.masach.com

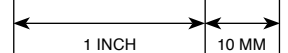

SHIELD TYPE:

SEAMLESS PROTECTIVE EMI/RFI CAGE



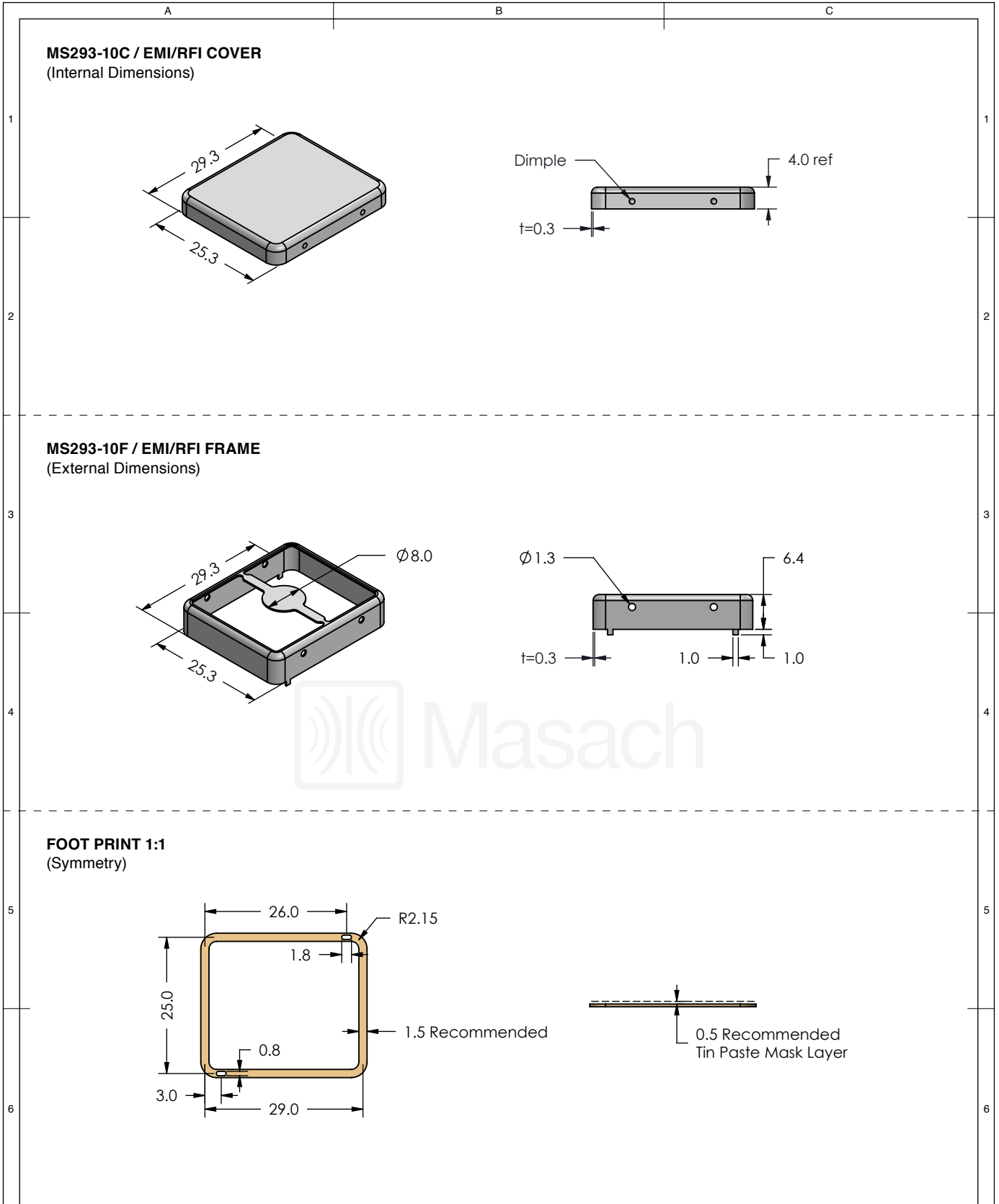

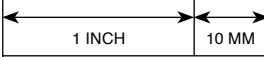

MMGS / PRINT 1:1 / A4

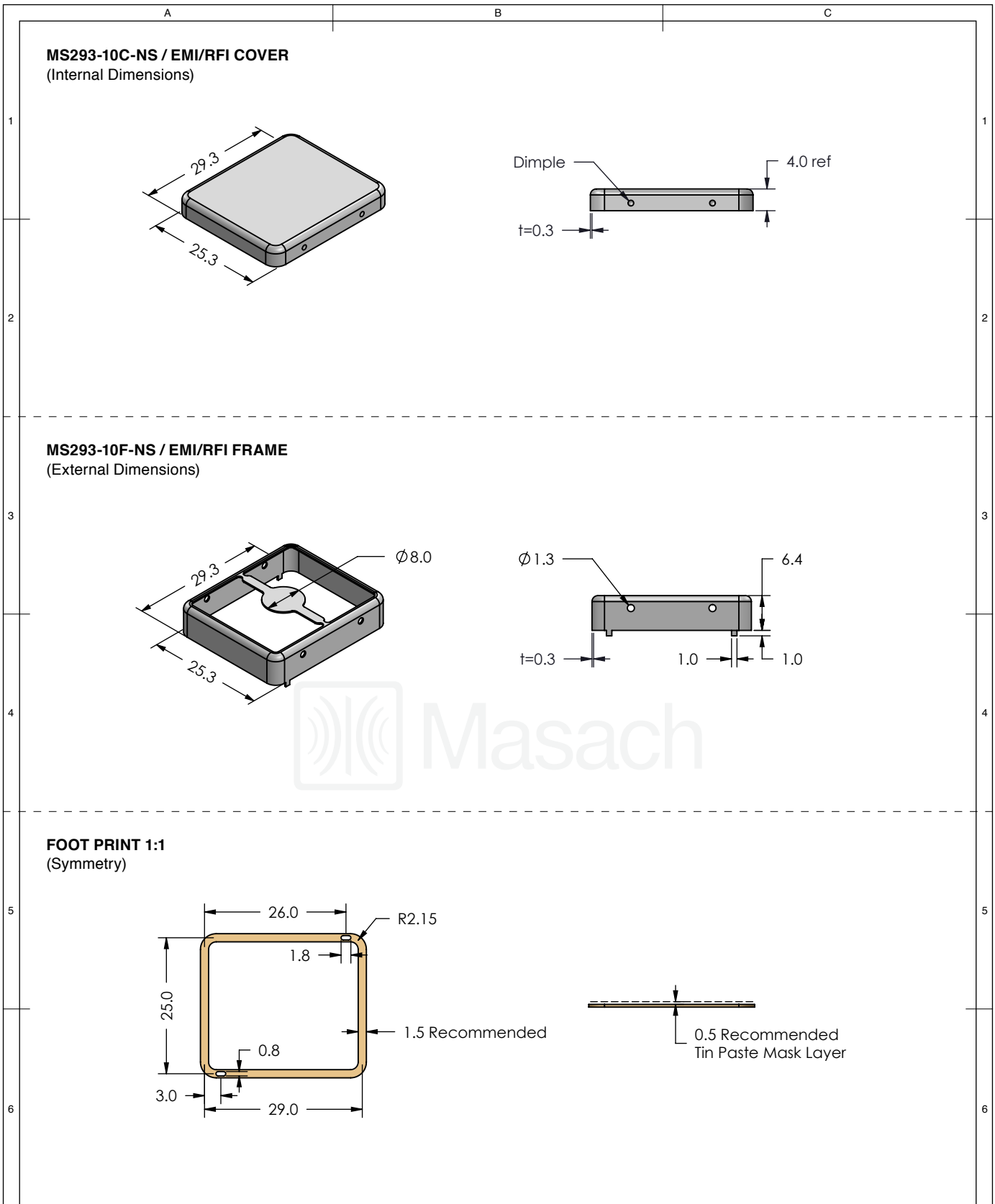

	MS SET PN:	DESCRIPTION:	MATERIAL:
	MS293-10	TWO-PIECE EM/RF SHIELD	TIN PLATED STEEL (1)
NOTE: (1) CRS ELECTROLYTIC TINPLATE (2) GENERAL TOLERANCE (+/-) 0.2MM			
© MASACH TECH LTD. 22 HAGANAN, MODIIN 7169513 ISRAEL T: (+972) 8-9754681 / F: (+972) 8-9754682 info@masach.com / www.masach.com	SHIELD TYPE:	 	
	SEAMLESS PROTECTIVE EMI/RFI CAGE		MMGS / PRINT 1:1 / A4

This product has been designed and manufactured by © Masach Tech Ltd. The use of this product in any type of electronic device or application is not under Masach Tech Ltd. liability.



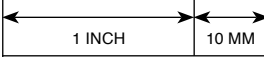

	MS SET PN:	DESCRIPTION:	MATERIAL:
	MS293-10-NS	TWO-PIECE EM/RF SHIELD	NICKEL SILVER (1)
NOTE: (1) UNS C77000 / UNS C73500 (2) GENERAL TOLERANCE (+/-) 0.2MM			
© MASACH TECH LTD. 22 HAGANAN, MODIIN 7169513 ISRAEL T: (+972) 8-9754681 / F: (+972) 8-9754682 info@masach.com / www.masach.com	SHIELD TYPE:	 	
	SEAMLESS PROTECTIVE EMI/RFI CAGE		MMGS / PRINT 1:1 / A4

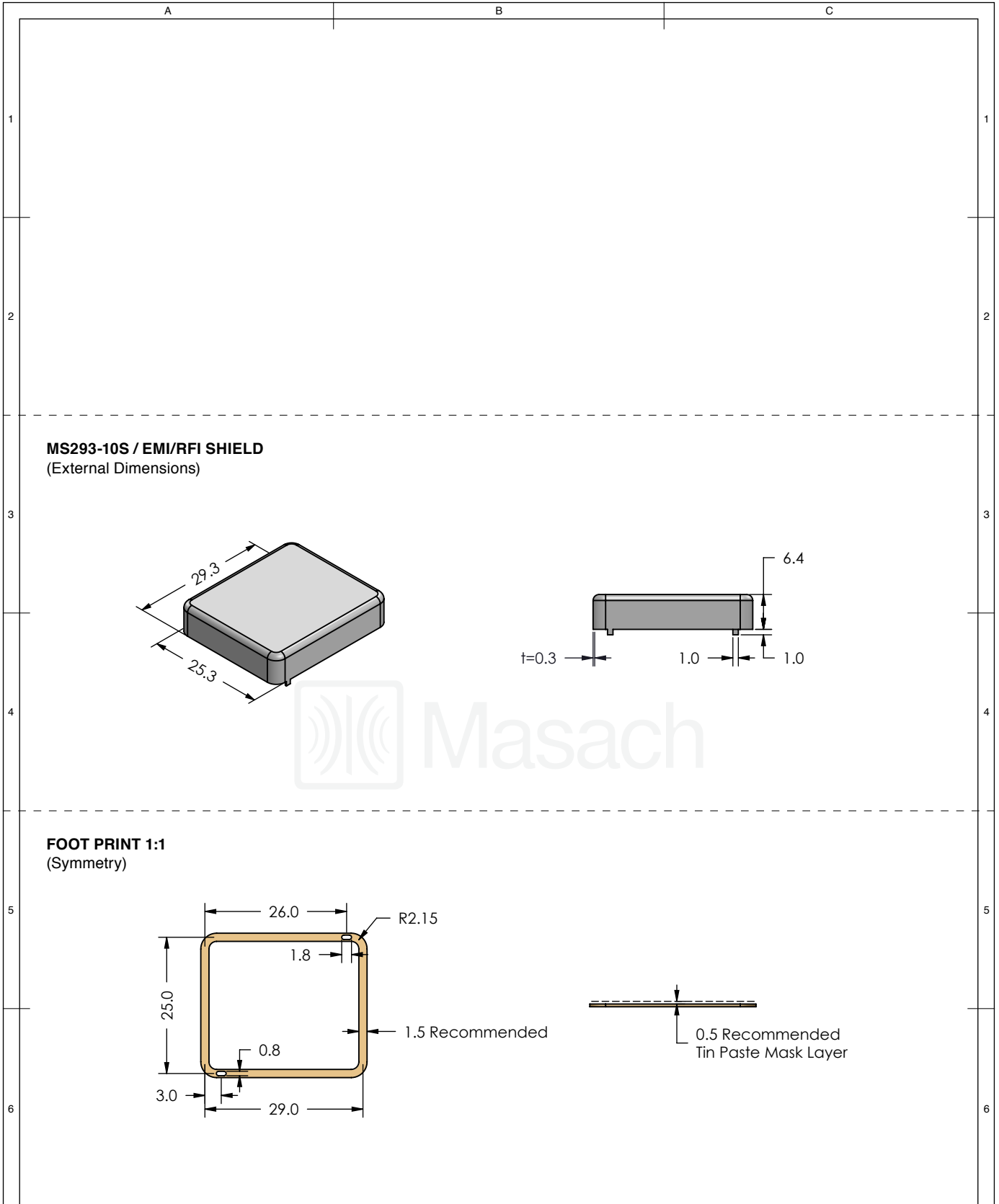
This product has been designed and manufactured by © Masach Tech Ltd. The use of this product in any type of electronic device or application is not under Masach Tech Ltd. liability.



MS293-10S / EMI/RFI SHIELD
(External Dimensions)

FOOT PRINT 1:1
(Symmetry)

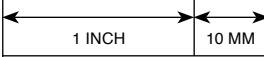
	MS ITEM PN:	DESCRIPTION:	MATERIAL:
	MS293-10S	ONE-PIECE EMI/RF SHIELD	TIN PLATED STEEL (1)
<p>NOTE: (1) CRS ELECTROLYTIC TINPLATE (2) GENERAL TOLERANCE (+/-) 0.2MM</p>			
<p>© MASACH TECH LTD. 22 HAGANAN, MODIIN 7169513 ISRAEL T: (+972) 8-9754681 / F: (+972) 8-9754682 info@masach.com / www.masach.com</p>	SHIELD TYPE:	 	
	SEAMLESS PROTECTIVE EMI/RFI CAGE		MMGS / PRINT 1:1 / A4

This product has been designed and manufactured by © Masach Tech Ltd. The use of this product in any type of electronic device or application is not under Masach Tech Ltd. liability.

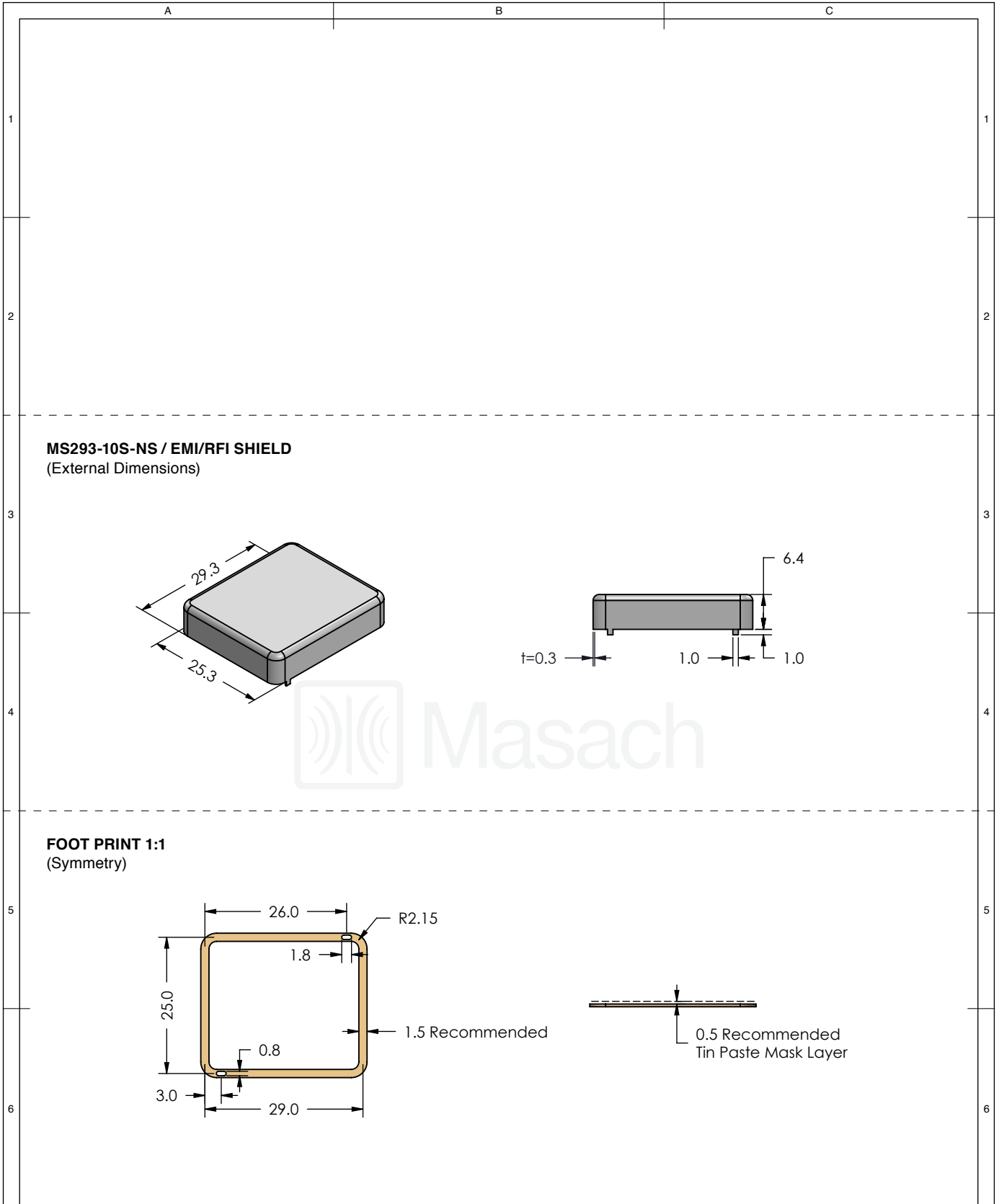

	MS ITEM PN:	DESCRIPTION:	MATERIAL:
	MS293-10S-NS	ONE-PIECE EMI/RF SHIELD	NICKEL SILVER (1)
NOTE: (1) UNS C77000 / UNS C73500 (2) GENERAL TOLERANCE (+/-) 0.2MM			
© MASACH TECH LTD. 22 HAGANAN, MODIIN 7169513 ISRAEL T: (+972) 8-9754681 / F: (+972) 8-9754682 info@masach.com / www.masach.com	SHIELD TYPE:		
	SEAMLESS PROTECTIVE EMI/RFI CAGE		MMGS / PRINT 1:1 / A4

This product has been designed and manufactured by © Masach Tech Ltd. The use of this product in any type of electronic device or application is not under Masach Tech Ltd. liability.

A

B

C

MS293-10* / SMALL PACKING TRAY / SMD

* COMPATIBLE TO ALL SHIELD CONFIGURATIONS

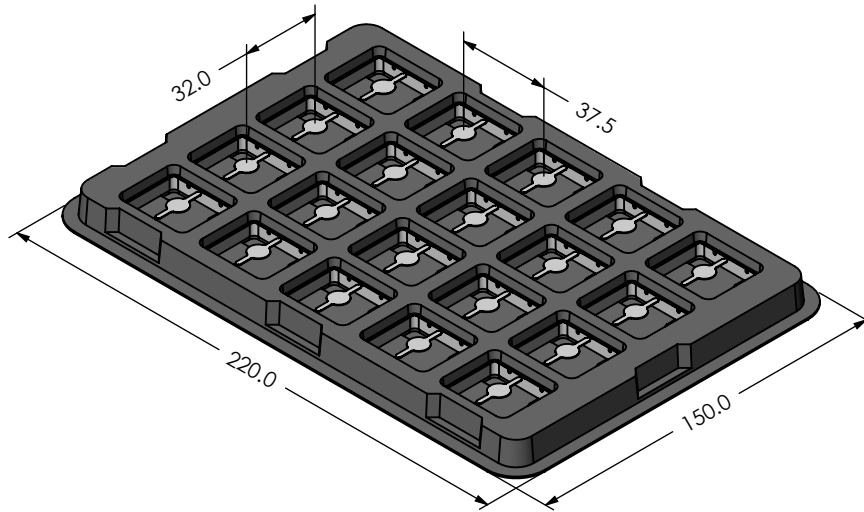

MS293-10* / LARGE PACKING TRAY / SMD

* COMPATIBLE TO ALL SHIELD CONFIGURATIONS

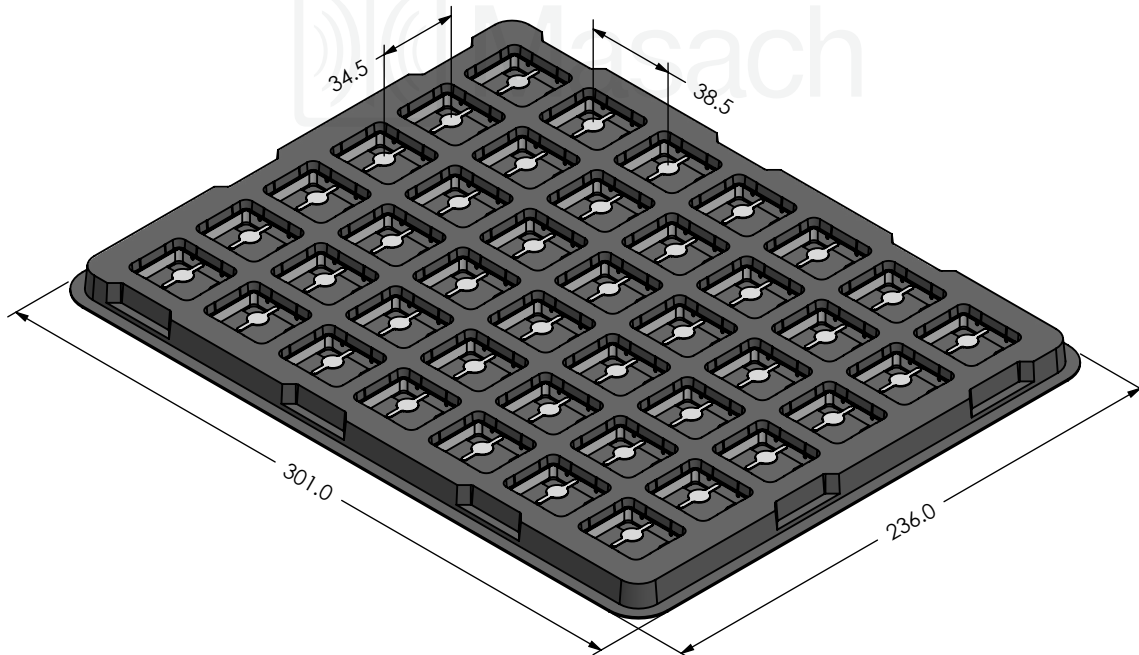

MS PN:

DESCRIPTION:

MATERIAL:

© MASACH TECH LTD.
22 HAGANAN, MODIIN 7169513 ISRAEL
T: (+972) 8-9754681 / F: (+972) 8-9754682
info@masach.com / www.masach.com

SHIELD TYPE:

SEAMLESS PROTECTIVE EMI/RFI CAGE



1 INCH

10 MM

MMGS / PRINT 1:1 / A4

This product has been designed and manufactured by © Masach Tech Ltd. The use of this product in any type of electronic device or application is not under Masach Tech Ltd. liability.

[BACK TO TOP](#)

X-ON Electronics

Largest Supplier of Electrical and Electronic Components

Click to view similar products for [EMI Gaskets, Sheets, Absorbers & Shielding](#) category:

Click to view products by [Masach](#) manufacturer:

Other Similar products are found below :

[8101010140](#) [8563-0090-89](#) [1194-7.7X10](#) [1245-34"X18YD](#) [1267](#) [1345-3/8x18yrd](#) [1554907-1](#) [2320002000](#) [2320014700](#) [SG293037DS](#)
[ST005PCN50](#) [55005107](#) [38M4040AA0606](#) [46J5N02020.NN00](#) [1125-8X10](#) [1126X1"](#) [1170-3/4X18YDS](#) [1170-7.7x10](#) [1183-12"X18YD](#) [6-](#)
[34T-BD-0.315](#) [SG125187D-24](#) [SG125250R-24](#) [SG187375R-24](#) [SG284050DS](#) [8402010540](#) [KIT TECH CLIP](#) [10-40450-28S](#) [1245](#) [1267-](#)
[1/2"x18yd](#) [46J8501020.NN00](#) [1170-1/4"x18yd](#) [AL-36FR-1x54.5](#) [3013310A](#) [1194X1"](#) [3020604](#) [3021302](#) [3031313](#) [260709](#) [3021310](#) [6-](#)
[34UT-070-BD-16](#) [303076048](#) [46J5N03020.NN00](#) [30206025](#) [30395641](#) [3030403](#) [3690103020](#) [HNY-LT15CU4241](#) [46X7503020.NN00](#)
[46W5E02520.NN00](#) [302095032](#)