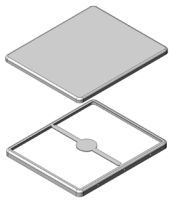
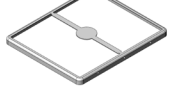
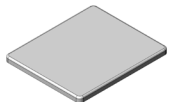

MS595-10*

DRAWN EMI/RFI SHIELD DATA-SHEET

*OPTIONAL SHIELD CONFIGURATIONS

| MS SHIELD | MS SET PN. | MS ITEM PN. | DESCRIPTION | RAW MATERIAL |
|--|-------------|--------------|------------------------|-----------------|
|  | MS595-10 | MS595-10C | TWO-PIECE SHIELD COVER | TIN STEEL* |
| | | MS595-10F | TWO-PIECE SHIELD FRAME | |
|  | MS595-10-NS | MS595-10C-NS | TWO-PIECE SHIELD COVER | NICKEL SILVER** |
| | | MS595-10F-NS | TWO-PIECE SHIELD FRAME | |
|  | | MS595-10S | ONE-PIECE SHIELD | TIN STEEL* |
| | | MS595-10S-NS | ONE-PIECE SHIELD | NICKEL SILVER** |

* TIN-PLATED STEEL: CRS ELECTROLYTIC TINPLATE

** NICKEL SILVER: UNS C77000 / UNS C73500



| | | |
|--------|--------------|-----------|
| MS PN: | DESCRIPTION: | MATERIAL: |
| | | |

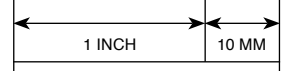

© MASACH TECH LTD.
22 HAGANAN, MODIIN 7169513 ISRAEL
T: (+972) 8-9754681 / F: (+972) 8-9754682
info@masach.com / www.masach.com

| |
|---|
| SHIELD TYPE: |
| SEAMLESS PROTECTIVE EMI/RFI CAGE |



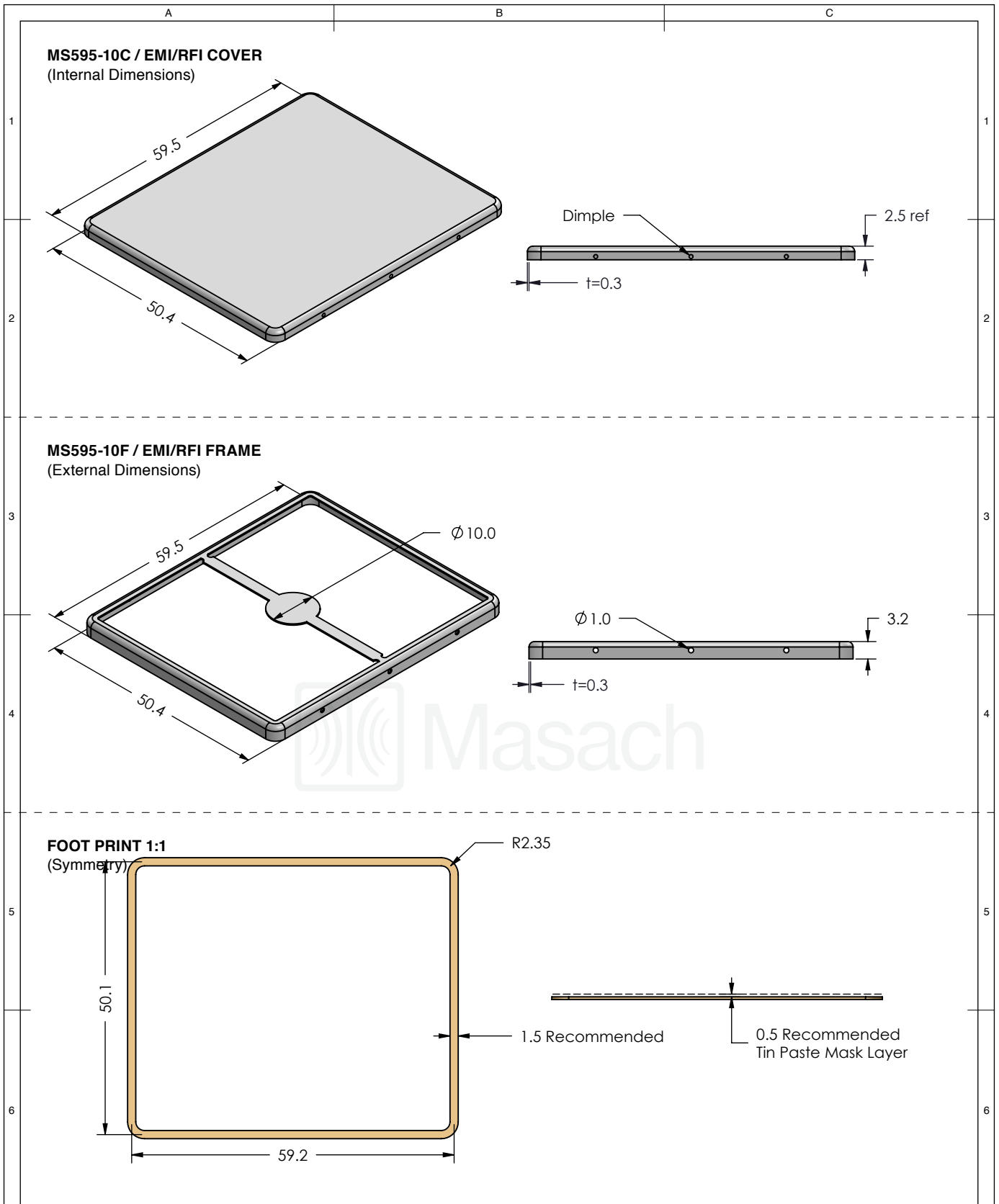

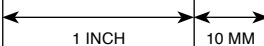

MMGS / PRINT 1:1 / A4

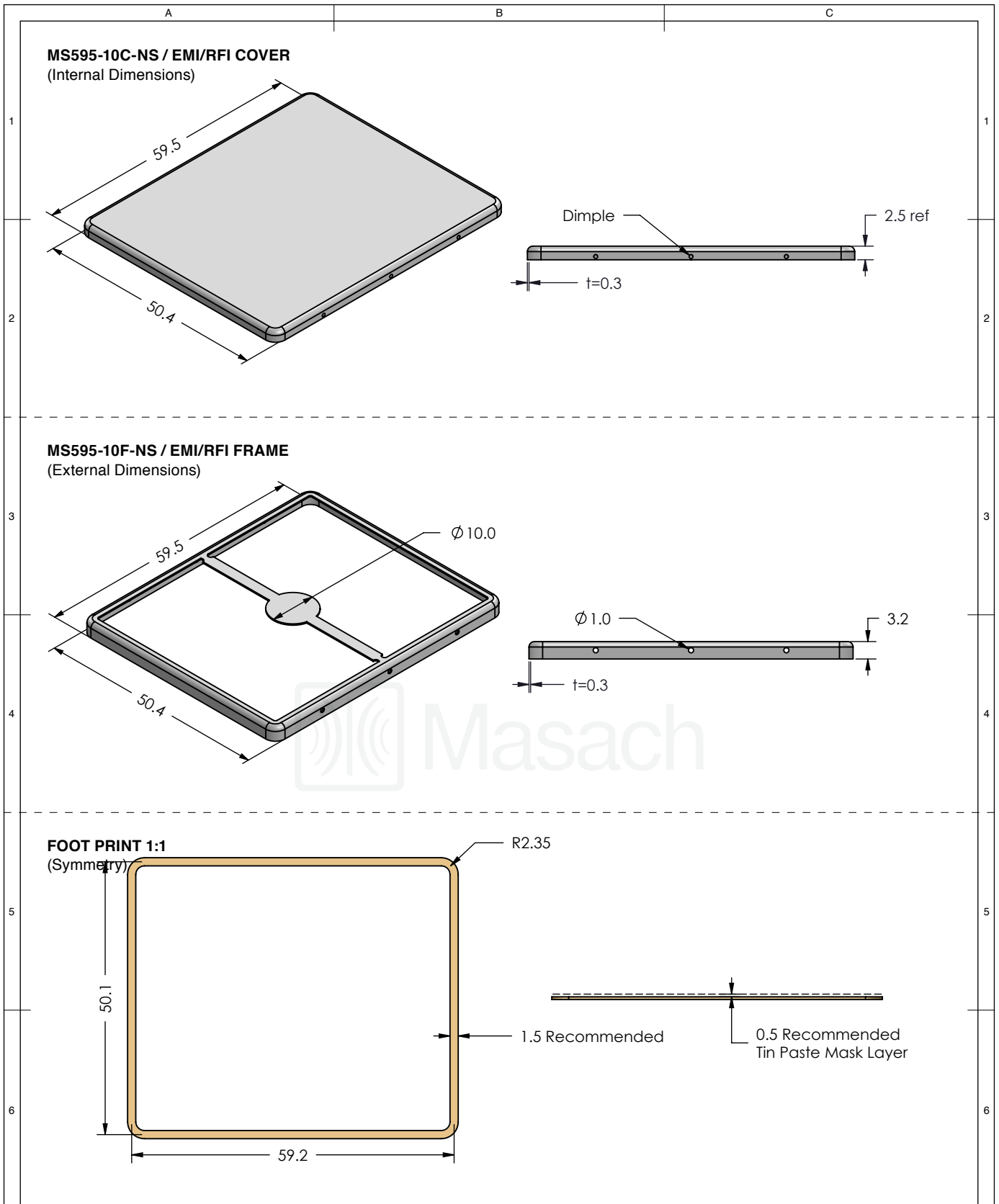

| | | | |
|---|---|---|---|
|  | MS SET PN: | DESCRIPTION: | MATERIAL: |
| | MS595-10 | TWO-PIECE EM/RF SHIELD | TIN PLATED STEEL (1) |
| NOTE: (1) CRS ELECTROLYTIC TINPLATE (2) GENERAL TOLERANCE (+/-) 0.2MM | | | |
| © MASACH TECH LTD. 22 HAGANAN, MODIIN 7169513 ISRAEL T: (+972) 8-9754681 / F: (+972) 8-9754682 info@masach.com / www.masach.com | SHIELD TYPE: |   |  |
| | SEAMLESS PROTECTIVE EMI/RFI CAGE | | MMGS / PRINT 1:1 / A4 |

This product has been designed and manufactured by © Masach Tech Ltd. The use of this product in any type of electronic device or application is not under Masach Tech Ltd. liability.



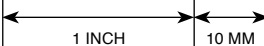

| | | | |
|---|---|---|---|
|  | MS SET PN: | DESCRIPTION: | MATERIAL: |
| | MS595-10-NS | TWO-PIECE EMI/RF SHIELD | NICKEL SILVER (1) |
| NOTE: (1) UNS C77000 / UNS C73500 (2) GENERAL TOLERANCE (+/-) 0.2MM | | | |
| © MASACH TECH LTD. 22 HAGANAN, MODIIN 7169513 ISRAEL T: (+972) 8-9754681 / F: (+972) 8-9754682 info@masach.com / www.masach.com | SHIELD TYPE: |   |  |
| | SEAMLESS PROTECTIVE EMI/RFI CAGE | | MMGS / PRINT 1:1 / A4 |

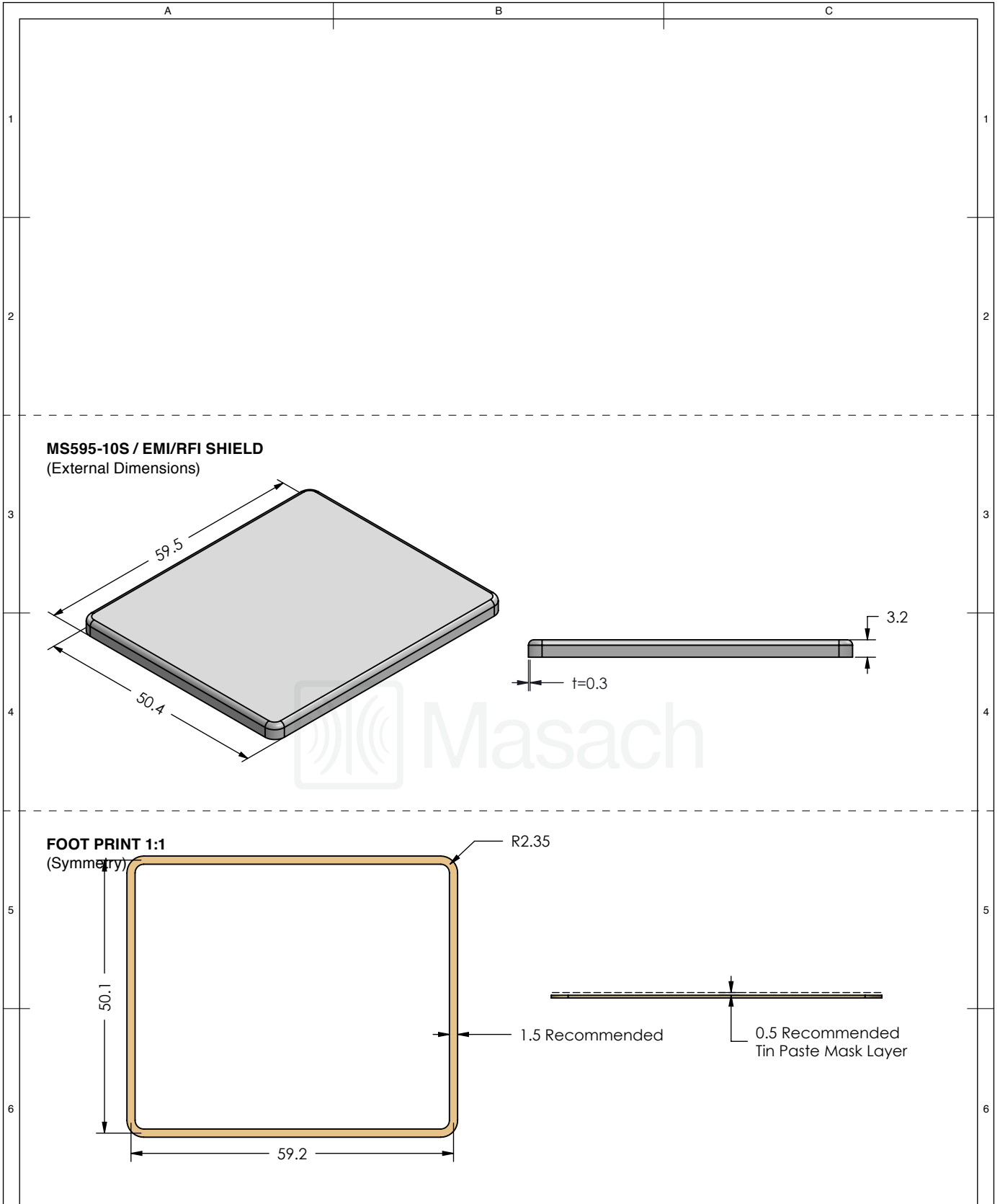
This product has been designed and manufactured by © Masach Tech Ltd. The use of this product in any type of electronic device or application is not under Masach Tech Ltd. liability.



MS595-10S / EMI/RFI SHIELD
(External Dimensions)

FOOT PRINT 1:1
(Symmetry)

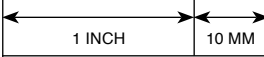

| | | | |
|---|---|---|---|
|  | MS ITEM PN: | DESCRIPTION: | MATERIAL: |
| | MS595-10S | ONE-PIECE EMI/RF SHIELD | TIN PLATED STEEL (1) |
| NOTE: (1) CRS ELECTROLYTIC TINPLATE (2) GENERAL TOLERANCE (+/-) 0.2MM | | | |
| © MASACH TECH LTD. 22 HAGANAN, MODIIN 7169513 ISRAEL T: (+972) 8-9754681 / F: (+972) 8-9754682 info@masach.com / www.masach.com | SHIELD TYPE: |   |  |
| | SEAMLESS PROTECTIVE EMI/RFI CAGE | | MMGS / PRINT 1:1 / A4 |

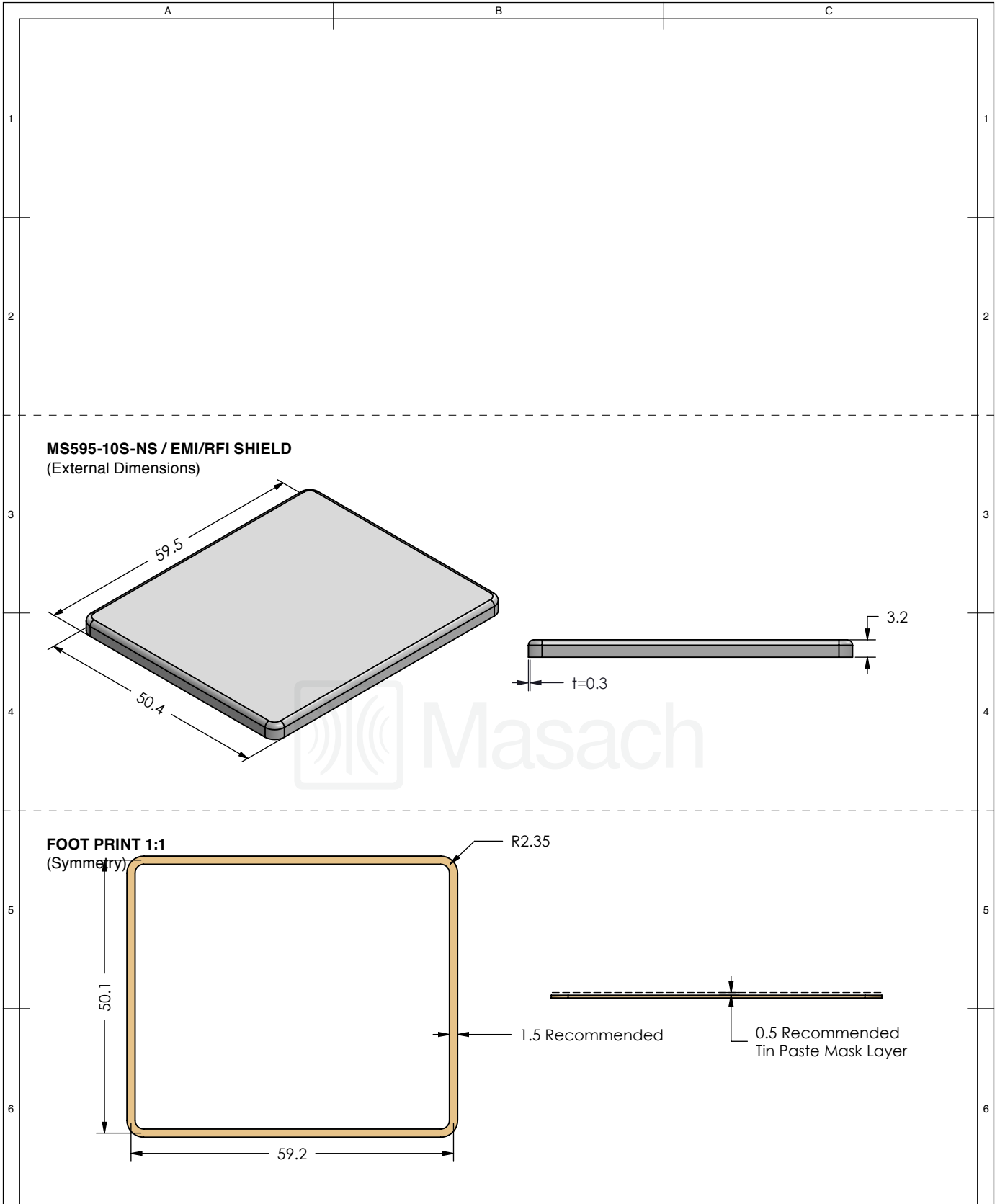
This product has been designed and manufactured by © Masach Tech Ltd. The use of this product in any type of electronic device or application is not under Masach Tech Ltd. liability.



MS595-10S-NS / EMI/RFI SHIELD
(External Dimensions)

FOOT PRINT 1:1
(Symmetry)

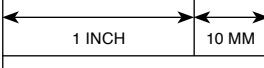
| | | | |
|---|--|---|---|
|  | MS ITEM PN: | DESCRIPTION: | MATERIAL: |
| | MS595-10S-NS | ONE-PIECE EMI/RF SHIELD | NICKEL SILVER (1) |
| | NOTE: (1) UNS C77000 / UNS C73500 (2) GENERAL TOLERANCE (+/-) 0.2MM | | |
| © MASACH TECH LTD. 22 HAGANAN, MODIIN 7169513 ISRAEL T: (+972) 8-9754681 / F: (+972) 8-9754682 info@masach.com / www.masach.com | SHIELD TYPE: |   |  |
| | SEAMLESS PROTECTIVE EMI/RFI CAGE | | MMGS / PRINT 1:1 / A4 |

This product has been designed and manufactured by © Masach Tech Ltd. The use of this product in any type of electronic device or application is not under Masach Tech Ltd. liability.

A

B

C

MS595-10* / SMALL PACKING TRAY / SMD

* COMPATIBLE TO ALL SHIELD CONFIGURATIONS

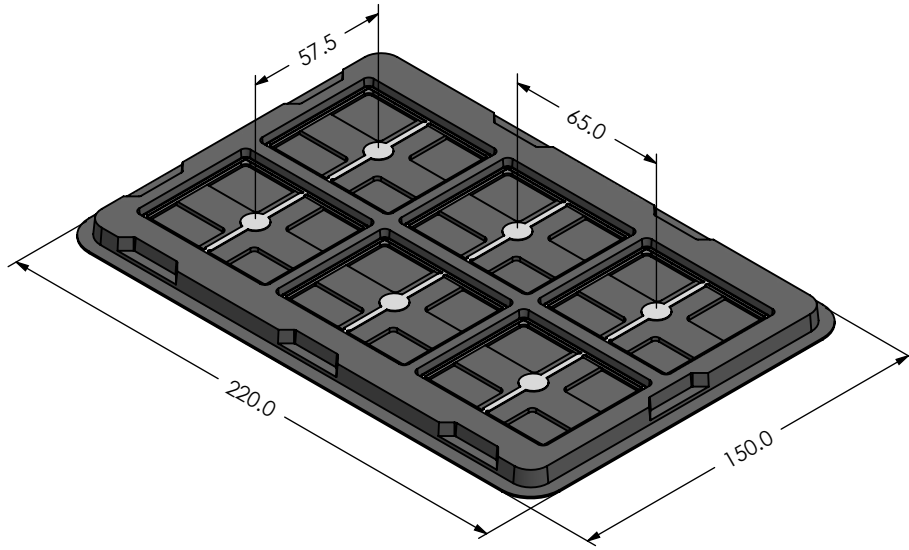

MS595-10* / LARGE PACKING TRAY / SMD

* COMPATIBLE TO ALL SHIELD CONFIGURATIONS

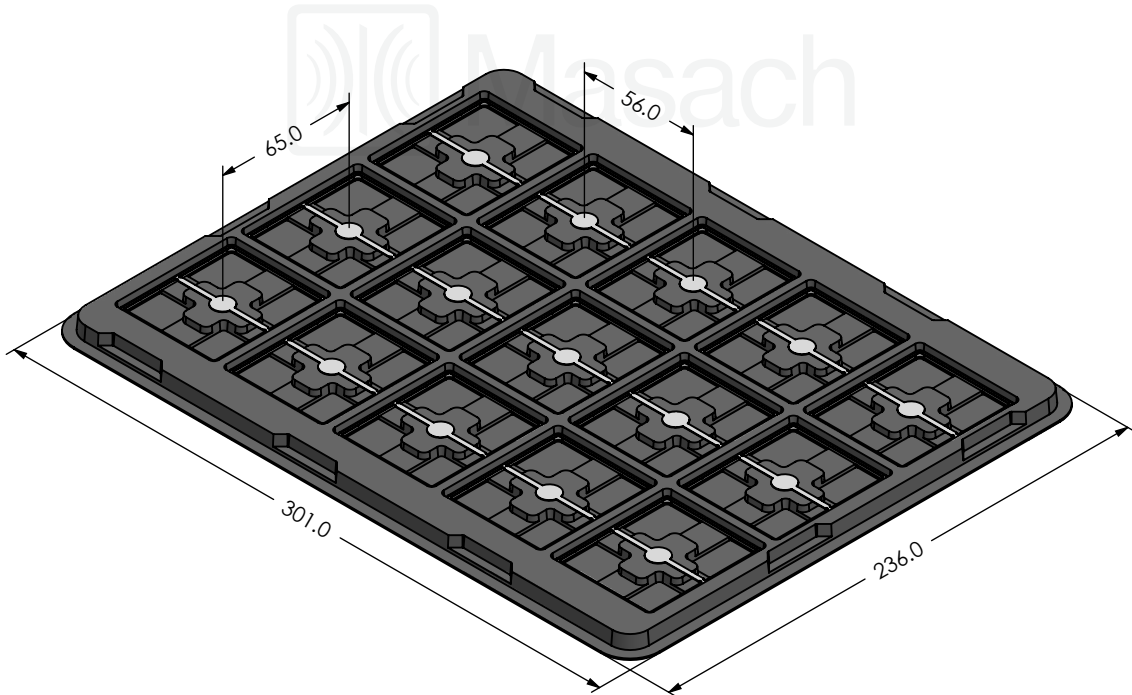

MS PN:

DESCRIPTION:

MATERIAL:

© MASACH TECH LTD.
 22 HAGANAN, MODIIN 7169513 ISRAEL
 T: (+972) 8-9754681 / F: (+972) 8-9754682
 info@masach.com / www.masach.com

SHIELD TYPE:

SEAMLESS PROTECTIVE EMI/RFI CAGE

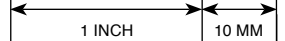

MMGS / PRINT 1:1 / A4

This product has been designed and manufactured by © Masach Tech Ltd. The use of this product in any type of electronic device or application is not under Masach Tech Ltd. liability.

[BACK TO TOP](#)

X-ON Electronics

Largest Supplier of Electrical and Electronic Components

Click to view similar products for [EMI Gaskets, Sheets, Absorbers & Shielding](#) category:

Click to view products by [Masach](#) manufacturer:

Other Similar products are found below :

[8101010140](#) [8563-0090-89](#) [1194-7.7X10](#) [1245-34"X18YD](#) [1267](#) [1345-3/8x18yrd](#) [1554907-1](#) [2320002000](#) [2320014700](#) [SG293037DS](#)
[ST005PCN50](#) [55005107](#) [38M4040AA0606](#) [46J5N02020.NN00](#) [1125-8X10](#) [1126X1"](#) [1170-3/4X18YDS](#) [1170-7.7x10](#) [1183-12"X18YD](#) [6-](#)
[34T-BD-0.315](#) [SG125187D-24](#) [SG125250R-24](#) [SG187375R-24](#) [SG284050DS](#) [8402010540](#) [KIT TECH CLIP](#) [1194](#) [10-40450-28S](#) [1245](#)
[1267-1/2"x18yd](#) [46J8501020.NN00](#) [1170-1/4"x18yd](#) [AL-36FR-1x54.5](#) [3013310A](#) [1194X1"](#) [3020604](#) [3021302](#) [3031313](#) [260709](#) [3021310](#) [6-](#)
[34UT-070-BD-16](#) [303076048](#) [46J5N03020.NN00](#) [30206025](#) [30395641](#) [3030403](#) [3690103020](#) [HNY-LT15CU4241](#) [46X7503020.NN00](#)
[46W5E02520.NN00](#)