

Features

- Low power loss,high efficiency
- High reliability
- RoHS product

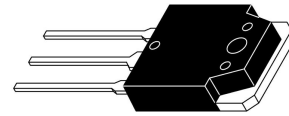

Applications

- Snubber diode
- Switch power supply
- Anti parallel Diode for high frequency switching devices

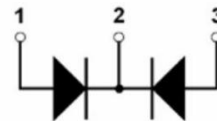

Absolute Maximum Ratings(Tc=25°C)

Parameter	Symbol	Test Conditions	Values	Unit
Repetitive Peak Reverse Voltage	V_{RRM}		200	V
Average Output Current	I_o	duty=1/2, Tc=115°C Square wave	25*	A
Surge Current	I_{FSM}	Sine wave 10ms	250	A
Power Dissipation	P_D		156	W
Junction Temperature	T_J		-65~150	°C
Storage Temperature Range	T_{STG}		-65~150	
Thermal Resistance(3P)	$R_{\theta JC}$	Junction-to-Case	0.8	°C/W

Electrical Characteristics(Tc=25°C unless otherwise specified)

Parameter	Symbol	Test Conditions	Min.	Typ.	Max.	Unit	
Reverse Current	I_{RRM}	$V_R=V_{RRM}$	Tj=25°C	-	-	50	μA
			Tj=125°C	-	-	500	μA
Forward Voltage Drop	V_{FM}	$I_{FM}=10.0A$	Tj=25°C	-	0.9	1.1	V
			Tj=125°C	-	-	1.0	V
Reverse Recovery Time	t_{rr}	IF=1A, VR=30V diF/dt=-200A/us	-	22	35	ns	

Electrical characteristics(Curves)

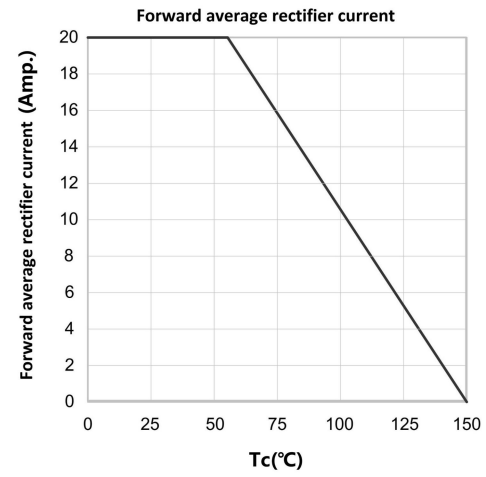
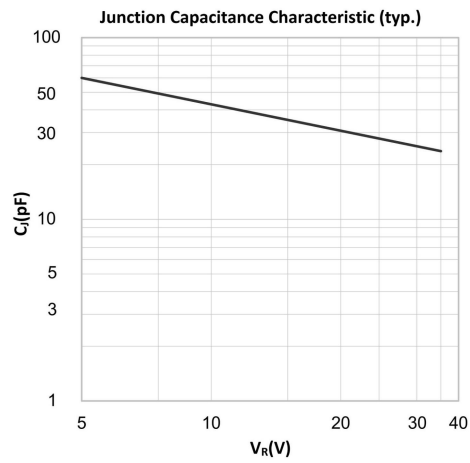
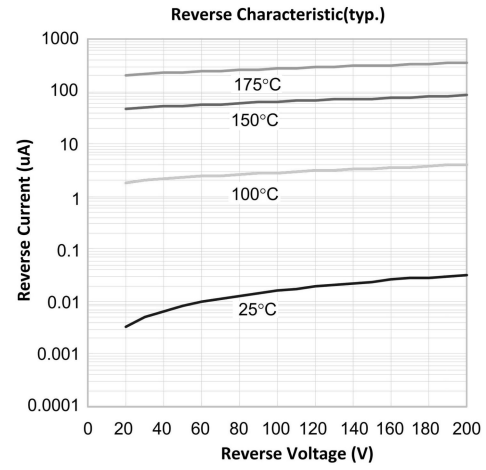
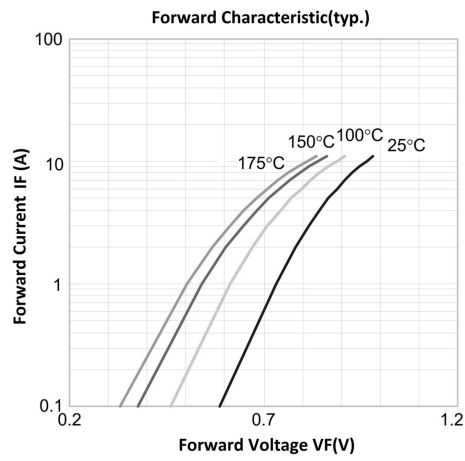

Package outline dimension

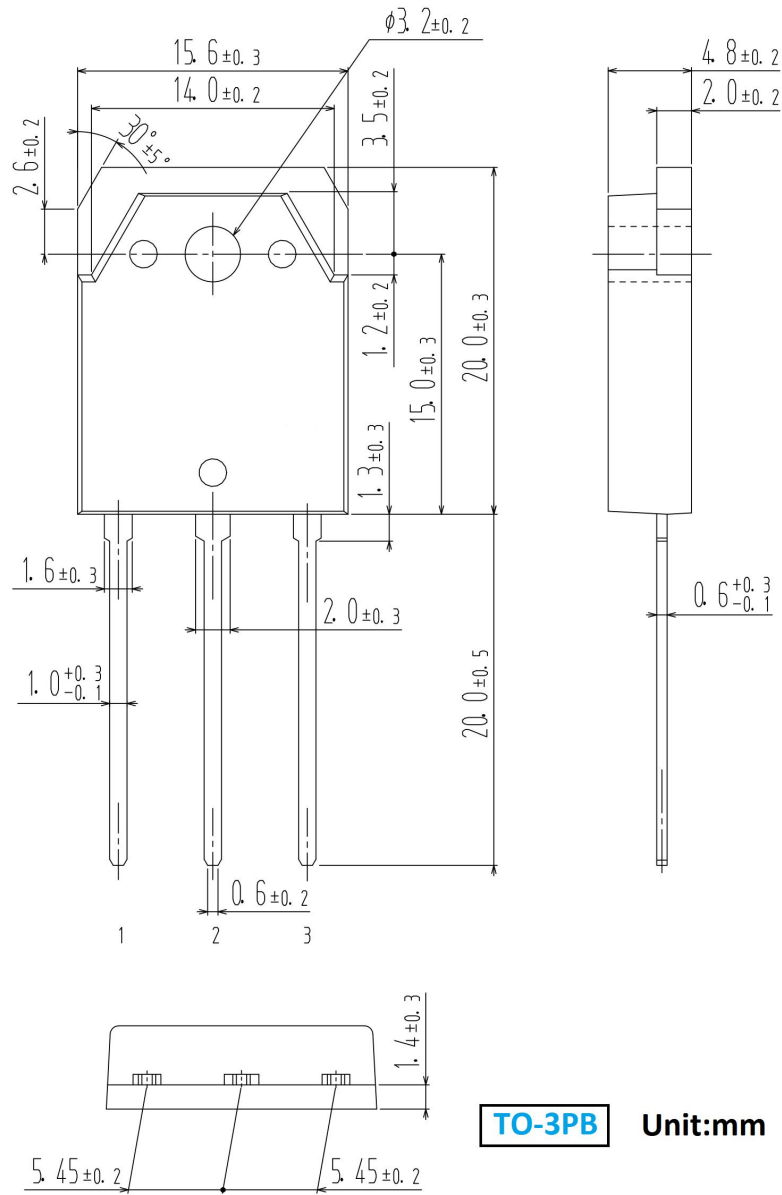

X-ON Electronics

Largest Supplier of Electrical and Electronic Components

Click to view similar products for [Rectifiers](#) category:

Click to view products by [MASPOWER](#) manufacturer:

Other Similar products are found below :

[70HFR40](#) [FR105 R0](#) [RL252-TP](#) [1N5397](#) [JANTX1N5634A](#) [1N4005-TR](#) [1N4007-BP](#) [UFS120Je3/TR13](#) [20ETS12S](#) [RRE02VS6SGTR](#)
[MS306](#) [A1N5404G-G](#) [CRF02\(T5L,TEMQ\)](#) [ACGRB207-HF](#) [CLH07\(TE16L,Q\)](#) [CLH03\(TE16L,Q\)](#) [1N5395-TP](#) [UES1302](#) [ACGRC307-HF](#)
[ACEFC304-HF](#) [DZ-1380](#) [85HFR60](#) [40HFR60](#) [70HF120](#) [85HFR80](#) [SCF7500](#) [SM100](#) [ACGRA4001-HF](#) [SKN70/08](#) [SKR70/08](#) [NTE5819](#)
[NTE5827](#) [NTE5828](#) [NTE5911](#) [NTE5915](#) [NTE6104](#) [NTE6163](#) [NTE6164](#) [NTE6165](#) [NTE6364](#) [TSD3G](#) [SET130312](#) [NRVUS110VT3G](#)
[UES1106](#) [UES1306](#) [NRVUS240VT3G](#) [D5FE60-5063](#) [R4000GPS-TP](#) [D4015L56TP](#) [UES1306HR2](#)