

ESTF45D60U

Ultra-Fast Soft Recovery Diode Module

DESCRIPTION

FRED from EST utilizes advanced processing techniques to achieve ultrafast recovery times and higher forward current. Its soft recovery characteristics and high reliability suit for wide industrial applications.

PRODUCT FEATURES

- Ultrafast Recovery Time
- Low Recovery Loss
- Soft Reverse Recovery Characteristics
- Low Leakage Current
- Low Forward Voltage
- High Surge Current Capability

APPLICATIONS

- Freewheeling, Snubber, Clamp
- Inversion Welder
- PFC
- Plating Power Supply
- Ultrasonic Cleaner and Welder
- Converter & Chopper
- UPS

Equivalent Circuit and Package

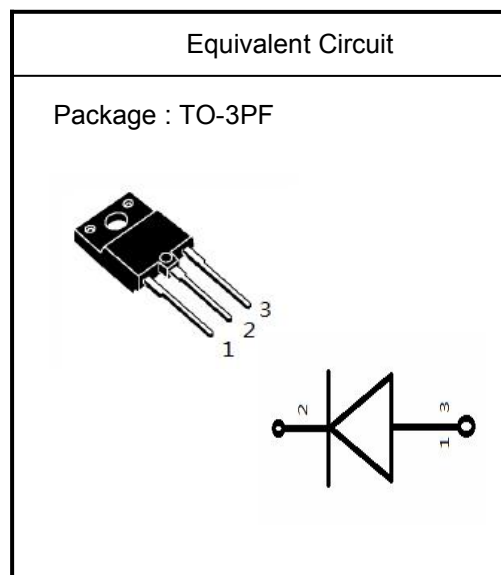

ABSOLUTE MAXIMUM RATINGS ($T_C = 25^\circ\text{C}$ unless otherwise specified)

Symbol	Parameter/Test Conditions		Values	Unit
V_R	Maximum D.C. Reverse Voltage		620	V
V_{RRM}	Maximum Repetitive Reverse Voltage			
$I_{F(AV)}$	Average Forward Current	$T_C = 100^\circ\text{C}$	45	
$I_{F(RMS)}$	RMS Forward Current	$T_C = 100^\circ\text{C}$	50	A
I_{FSM}	Non Repetitive Surge Forward Current	$T_J = 25^\circ\text{C}, t = 10\text{ms}, 50\text{Hz}, \text{Sine}$	300	
P_D	Power Dissipation		160	W
T_J	Junction Temperature		-55 to +150	$^\circ\text{C}$
T_{STG}	Storage Temperature Range		-55 to +125	$^\circ\text{C}$
Torque	To Heat Sink	Recommended (M3)	1.1	Nm
R_{thJC}	Junction to Case Thermal Resistance		0.8	$^\circ\text{C}/\text{W}$
Weight			6	g

ELECTRICAL CHARACTERISTICS ($T_C = 25^\circ\text{C}$ unless otherwise specified)

Symbol	Parameter/Test Conditions		Min.	Typ.	Max.	Unit
I_{RM}	Maximum Reverse Leakage Current	$V_R = 620\text{V}$			10	μA
		$V_R = 620\text{V}, T_J = 125^\circ\text{C}$			1	mA
V_F	Forward Voltage	$I_F = 30\text{A}$		2	2.2	V
		$I_F = 30\text{A}, T_J = 125^\circ\text{C}$		1.7		
t_{rr}	Reverse Recovery Time	$(I_F = 1\text{A}, di_F/dt = -200\text{A}/\mu\text{s}, V_R = 30\text{V})$		30	35	ns
t_{rr}	Reverse Recovery Time	$(I_F = 0.5\text{A}, I_R = 1\text{A}, I_{RR} = 0.25\text{A})$		35	45	ns

ELECTRICAL CHARACTERISTICS ($T_C = 25^\circ\text{C}$ unless otherwise specified)

Symbol	Parameter/Test Conditions		Min.	Typ.	Max.	Unit
t_{rr}	Reverse Recovery Time	$I_F = 30\text{A}, V_R = 300\text{V},$ $di_F/dt = -200\text{A}/\mu\text{s}$		35		ns
I_{RRM}	Maximum Reverse Recovery Current				3	
Q_{RR}	Reverse Recovery Charge			128		nC
t_{rr}	Reverse Recovery Time	$I_F = 30\text{A}, V_R = 300\text{V},$ $di_F/dt = -200\text{A}/\mu\text{s}, T_J = 125^\circ\text{C}$		125		ns
I_{RRM}	Maximum Reverse Recovery Current				6	
Q_{RR}	Reverse Recovery Charge			475		nC

Typical Performance Curves

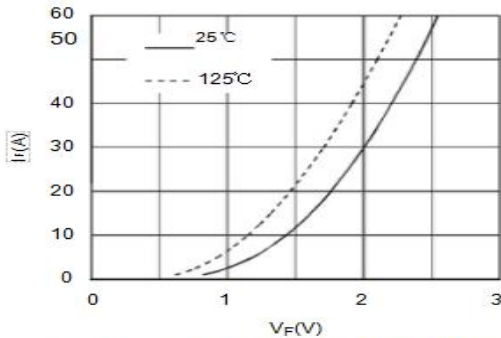

Figure 1. Forward Voltage Drop vs Forward Current

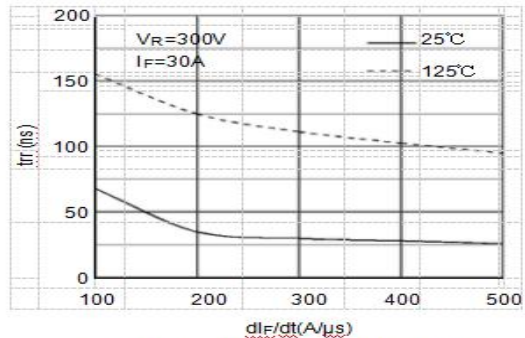

Figure 2. Reverse Recovery Time vs di_F/dt

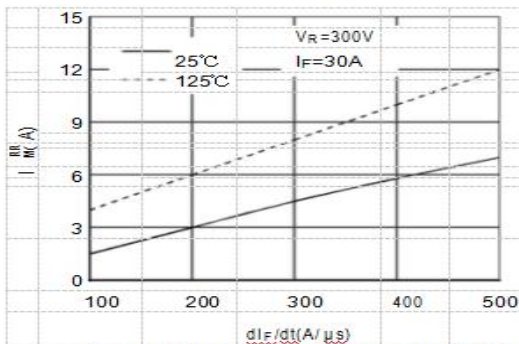

Figure 3. Reverse Recovery Current vs di_F/dt

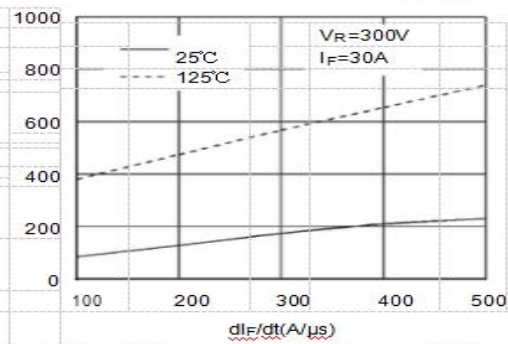

Figure 4. Reverse Recovery Charge vs di_F/dt

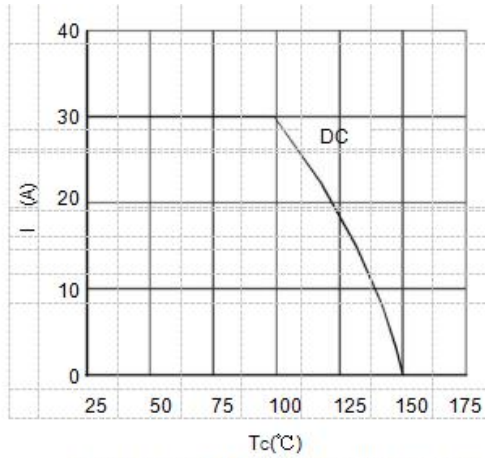

Figure 5. Forward current vs Case temperature

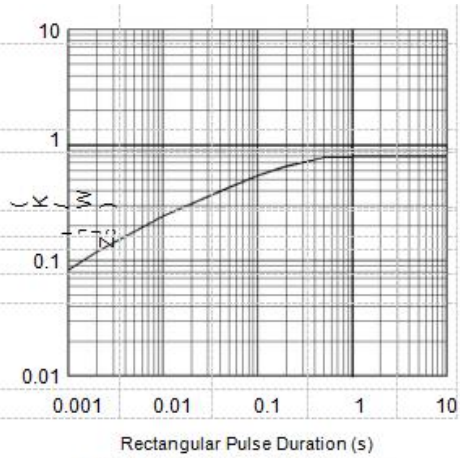

Figure 6. Transient Thermal Impedance

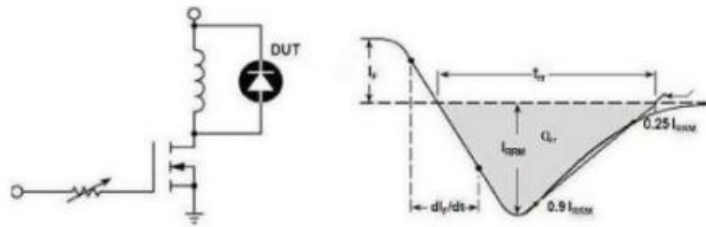
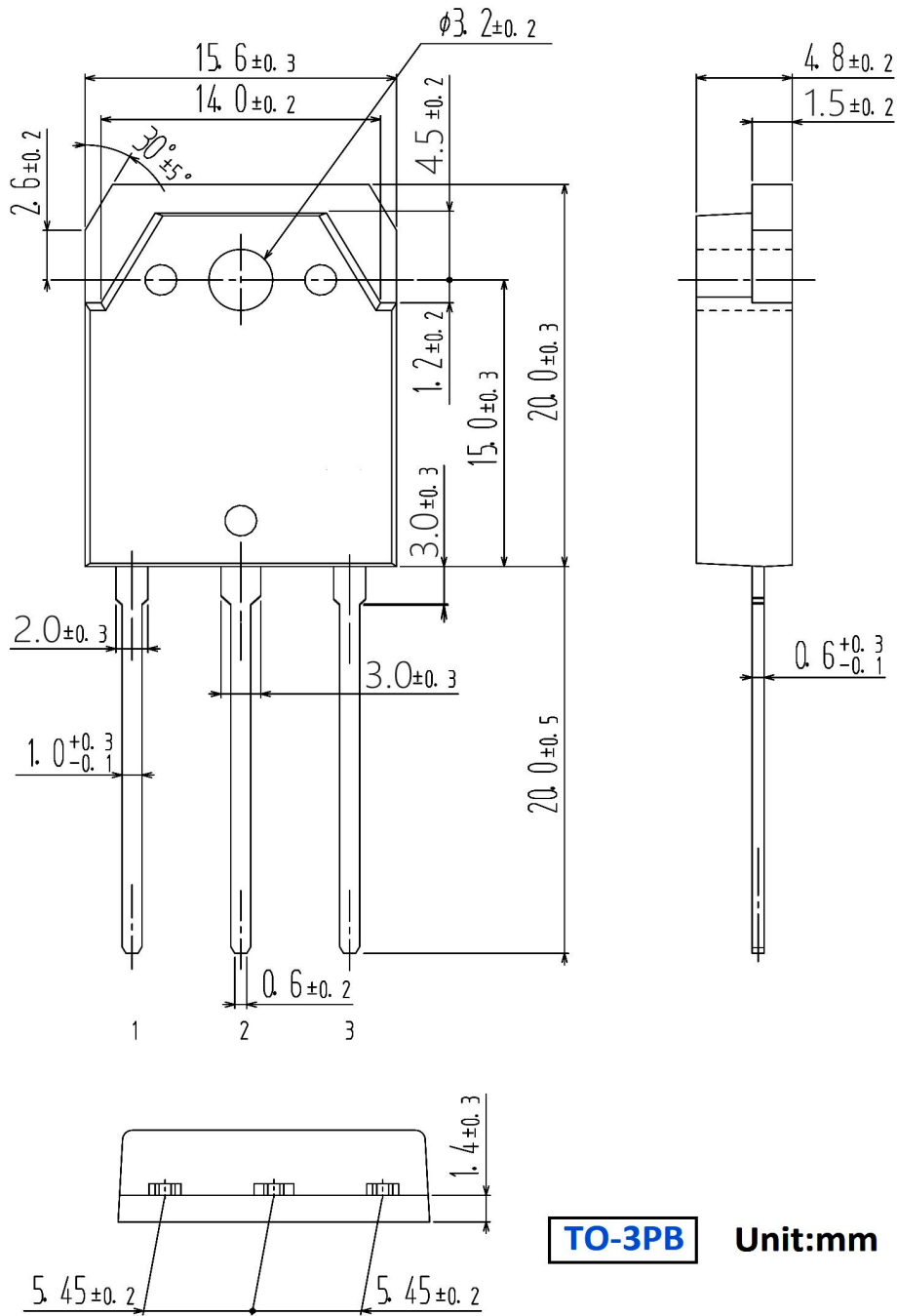

Figure 7. Diode Reverse Recovery Test Circuit and Waveform

Package outline dimension



X-ON Electronics

Largest Supplier of Electrical and Electronic Components

Click to view similar products for [Rectifiers](#) category:

Click to view products by [MASPOWER](#) manufacturer:

Other Similar products are found below :

[70HFR40](#) [FR105 R0](#) [RL252-TP](#) [1N5397](#) [JANTX1N5634A](#) [1N4005-TR](#) [1N4007-BP](#) [UFS120Je3/TR13](#) [20ETS12S](#) [RRE02VS6SGTR](#)
[MS306](#) [A1N5404G-G](#) [CRF02\(T5L,TEMQ\)](#) [ACGRB207-HF](#) [CLH07\(TE16L,Q\)](#) [CLH03\(TE16L,Q\)](#) [1N5395-TP](#) [UES1302](#) [ACGRC307-HF](#)
[ACEFC304-HF](#) [DZ-1380](#) [85HFR60](#) [40HFR60](#) [70HF120](#) [85HFR80](#) [SCF7500](#) [SM100](#) [ACGRA4001-HF](#) [SKN70/08](#) [SKR70/08](#) [NTE5819](#)
[NTE5827](#) [NTE5828](#) [NTE5911](#) [NTE5915](#) [NTE6104](#) [NTE6163](#) [NTE6164](#) [NTE6165](#) [NTE6364](#) [TSD3G](#) [SET130312](#) [NRVUS110VT3G](#)
[UES1106](#) [UES1306](#) [NRVUS240VT3G](#) [D5FE60-5063](#) [R4000GPS-TP](#) [D4015L56TP](#) [UES1306HR2](#)