

Features

- Ultra fast Recovery Time
- Low Recovery Loss
- Soft Reverse Recovery Characteristics
- Low Leakage Current
- Low Forward Voltage
- High Surge Current Capability

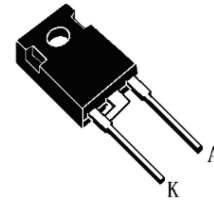

TO-2472L

Applications

- UPS
- PFC
- Freewheeling, Snubber, Clamp
- Inversion Welder
- Plating Power Supply
- Ultrasonic Cleaner and Welder
- Converter & Chopper



Absolute Maximum Ratings(Tc=25°C)

Parameter	Symbol	Test Conditions	Values	Unit
Repetitive Peak Reverse Voltage	V_{RRM}		1350	V
Average Output Current	$I_{F(AV)}$	$T_c=100^\circ\text{C}$	50	A
Peak one Cycle Surge Forward Current	I_{FSM}	Sine wave 10ms	540	A
power dissipation	P_D		334	W
Junction Temperature	T_J		-50 ~ 150	°C
Storage Temperature Range	T_{STG}		-50 ~ 150	
Thermal Resistance	$R_{\theta JC}$	Junction-to-Case	0.45	°C/W
To Heat Sink	Torque	M3	1.1	N.m
	Weight		6	g

Electrical Characteristics(Tc=25°C unless otherwise specified)

Parameter	Symbol	Test Conditions	Min.	Typ.	Max.	Unit	
Reverse Current	I_{RRM}	$V_R=V_{RRM}$	$T_j=25^\circ\text{C}$	-	-	10	μA
			$T_j=125^\circ\text{C}$	-	-	1	mA
Forward Voltage Drop	V_{FM}	$I_{FM}=50.0\text{A}$	$T_j=25^\circ\text{C}$	-	2.1	2.6	V
			$T_j=125^\circ\text{C}$	-	1.8	-	V

Reverse Recovery Time	t_{rr}	$I_F=1A, V_R=30V$ $di_F/dt=-200A/\mu s$	-	32	35	ns
Reverse Recovery Time	t_{rr}	$I_F=0.5A, I_R=1A, I_{RR}=0.25A$		70	80	ns

Electrical characteristics(Curves)

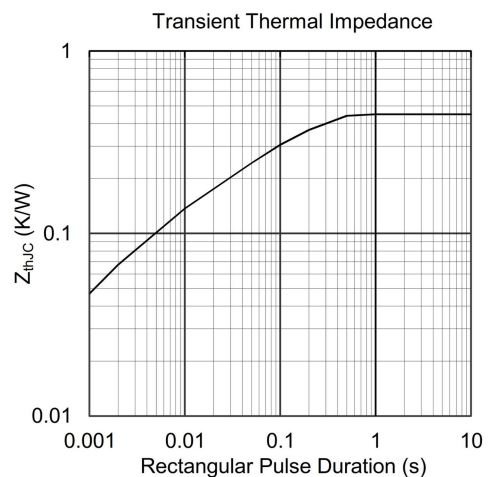
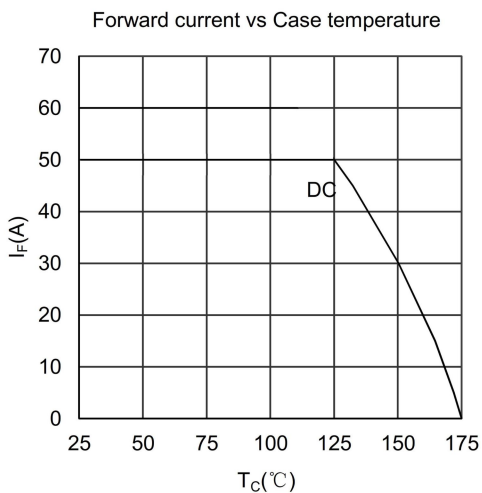
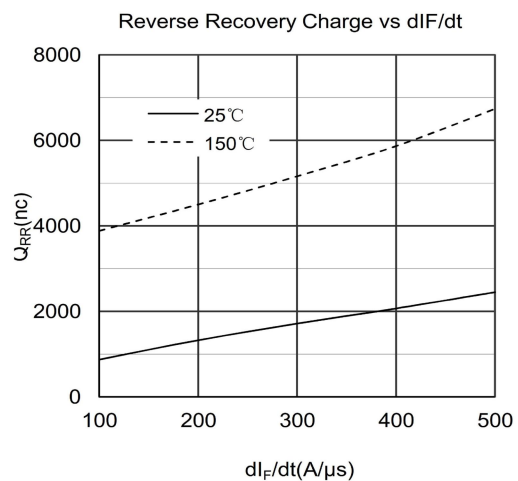
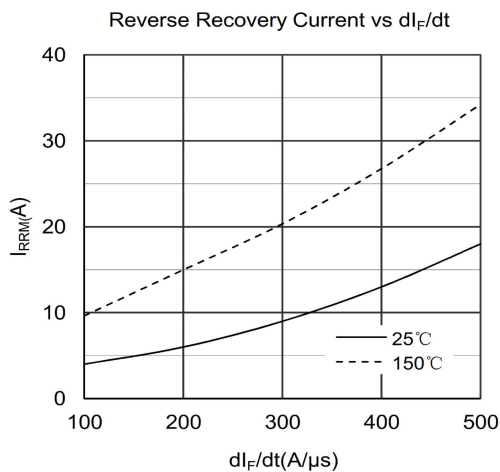
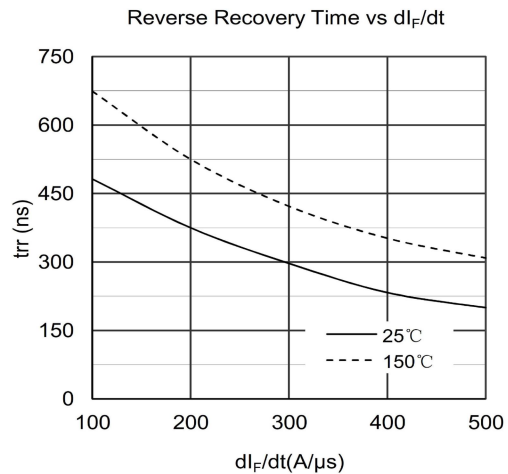
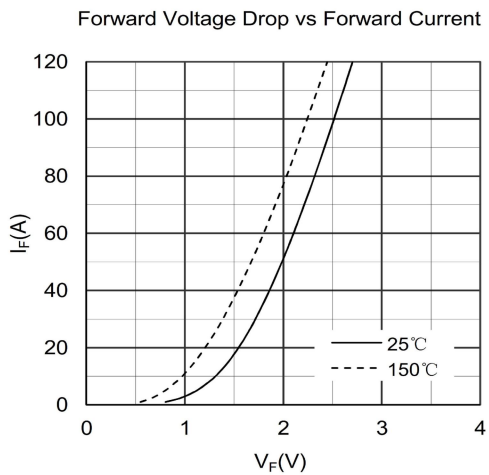

Diode Reverse Recovery Test Circuit and Waveform

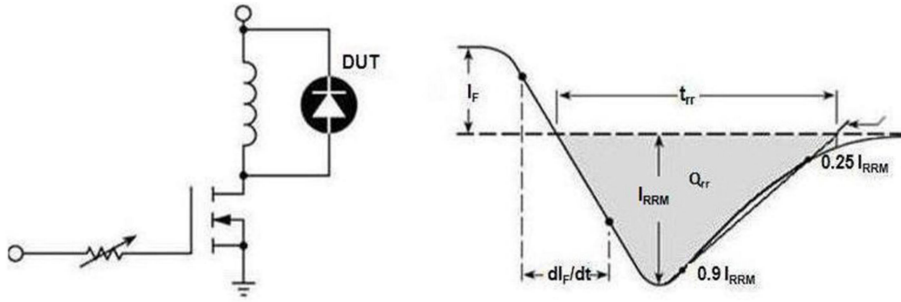

Package outline dimension

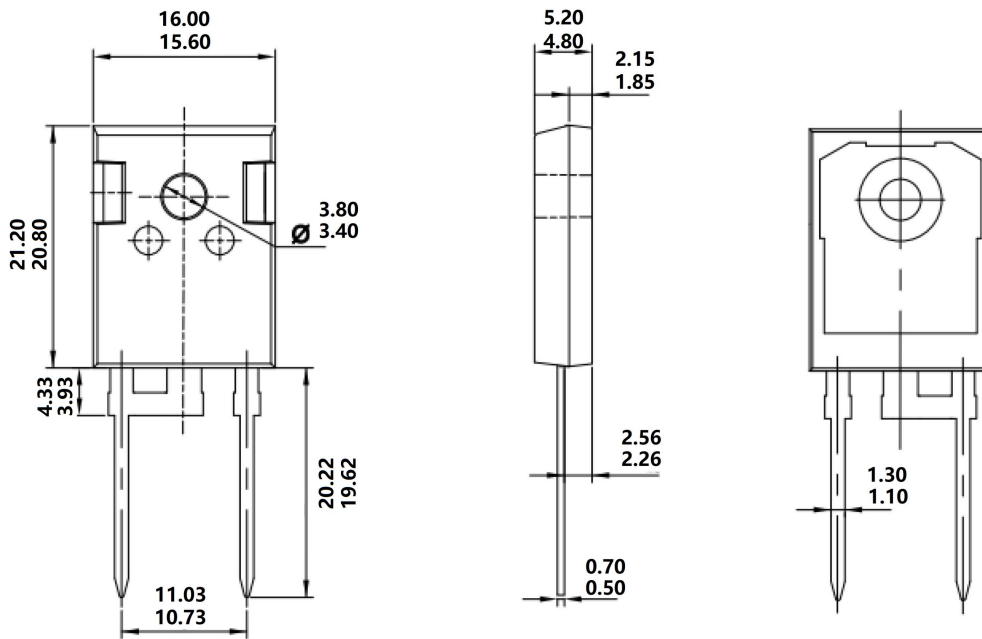

TO-247-2L

Unit: mm

X-ON Electronics

Largest Supplier of Electrical and Electronic Components

Click to view similar products for [Rectifiers](#) category:

Click to view products by [MASPOWER](#) manufacturer:

Other Similar products are found below :

[70HFR40](#) [FR105 R0](#) [RL252-TP](#) [1N5397](#) [JANTX1N5634A](#) [1N4005-TR](#) [1N4007-BP](#) [UFS120Je3/TR13](#) [20ETS12S](#) [RRE02VS6SGTR](#)
[MS306](#) [A1N5404G-G](#) [CRF02\(T5L,TEMQ\)](#) [ACGRB207-HF](#) [CLH07\(TE16L,Q\)](#) [CLH03\(TE16L,Q\)](#) [1N5395-TP](#) [UES1302](#) [ACGRC307-HF](#)
[ACEFC304-HF](#) [DZ-1380](#) [85HFR60](#) [40HFR60](#) [70HF120](#) [85HFR80](#) [SCF7500](#) [SM100](#) [ACGRA4001-HF](#) [SKN70/08](#) [SKR70/08](#) [NTE5819](#)
[NTE5827](#) [NTE5828](#) [NTE5911](#) [NTE5915](#) [NTE6104](#) [NTE6163](#) [NTE6164](#) [NTE6165](#) [NTE6364](#) [TSD3G](#) [SET130312](#) [NRVUS110VT3G](#)
[UES1106](#) [UES1306](#) [NRVUS240VT3G](#) [D5FE60-5063](#) [R4000GPS-TP](#) [D4015L56TP](#) [UES1306HR2](#)