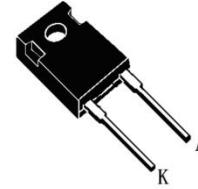

# ESTF60SS60US

## Fast Recovery Diode

### Features

- Repetitive Reverse Voltage :  $V_{RRM} = 600V$
- Forward Voltage Drop :  $V_F(\text{typ.}) = 1.5V$
- Average Forward Current :  $I_{F(AV)} = 60A$
- Fast Reverse Recovery Time :  $t_{rr}(\text{typ.}) = 45ns$
- RoHS product

**TO-2472L**

### Applications

- Switching Power Supplies
- Snubber diode
- Antiparalle Diode for high frequency Switching Devices



### Absolute Maximum Ratings @ $T_c=25^\circ C$

Symbol	Parameter	ratings	Unit
$V_{RRM}$	Repetitive peak reverse voltage @ $50\mu A$	600	V
$V_{RWM}$	Working Peak Reverse Voltage	600	V
$I_{F(AV)}$	Average forward current @ $T_c=100^\circ C$	60	A
$I_{FSM}$	Peak one Cycle Surge Forward @ $t=10ms$	480	A
$T_j$	Junction Temperature	-55~+175	$^\circ C$
$T_{STG}$	Storage temperature range	-55~+175	$^\circ C$

### Electrical Specifications @ $T_c=25^\circ C$

Symbol	Parameter		Ratings			Unit
			Min	Typ	Max	
$I_R$	$T_j=25^\circ C$	$V_R=V_{RRM}$			50	$\mu A$
	$T_j=125^\circ C$				800	$\mu A$
$V_F$	$T_j=25^\circ C$	$I_F=60A$		1.5	2.4	V
	$T_j=125^\circ C$				2.1	V
$T_{rr}$	$I_F=1A, V_R=30V, diF/dt=-200A/\mu s$				45	ns
$R_{th(j-c)}$	Thermal resistance from junction to case	TO-247-2L			0.34	$^\circ C/W$

### Typical Performance Curves

**IF vs VF**

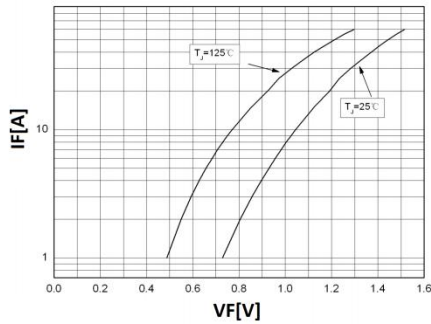

**IR vs VR**

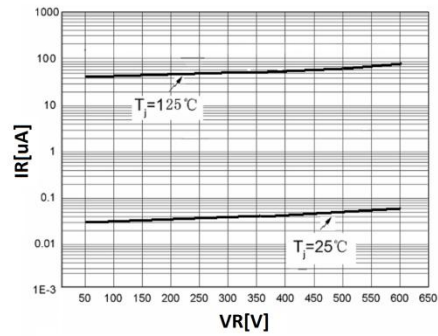

**CT vs VR**

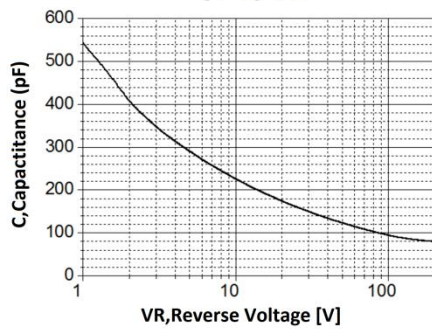

**Trr vs di/dt**

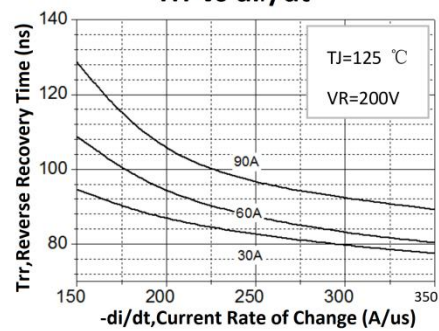

**Qrr vs di/dt**

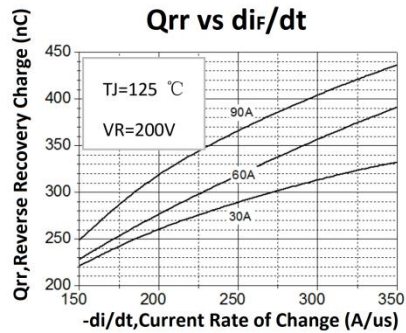

**Irrm vs di/dt**

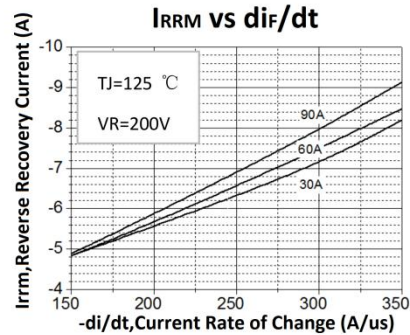

**IF vs TC**

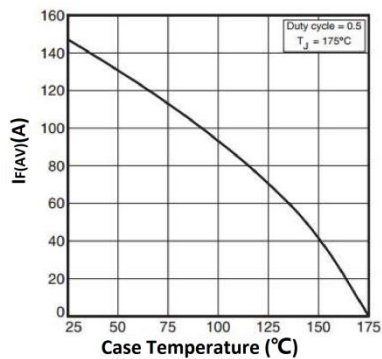

**Zθjc vs tp(s)**

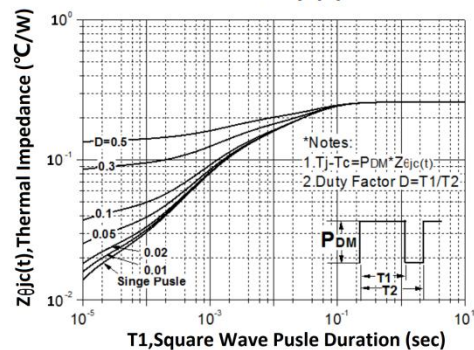

### Package

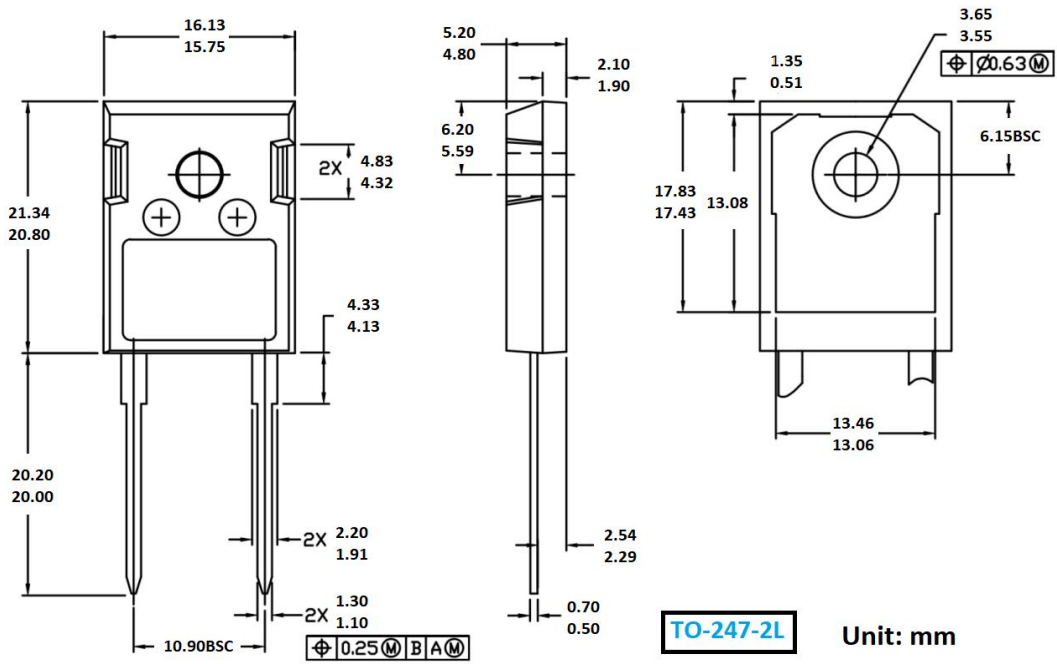

## X-ON Electronics

Largest Supplier of Electrical and Electronic Components

*Click to view similar products for [Rectifiers](#) category:*

*Click to view products by [MASPOWER](#) manufacturer:*

Other Similar products are found below :

[70HFR40](#) [FR105 R0](#) [RL252-TP](#) [1N5397](#) [JANTX1N5634A](#) [1N4005-TR](#) [1N4007-BP](#) [UFS120Je3/TR13](#) [20ETS12S](#) [RRE02VS6SGTR](#)  
[MS306](#) [A1N5404G-G](#) [CRF02\(T5L,TEMQ\)](#) [ACGRB207-HF](#) [CLH07\(TE16L,Q\)](#) [CLH03\(TE16L,Q\)](#) [1N5395-TP](#) [UES1302](#) [ACGRC307-HF](#)  
[ACEFC304-HF](#) [DZ-1380](#) [85HFR60](#) [40HFR60](#) [70HF120](#) [85HFR80](#) [SCF7500](#) [SM100](#) [ACGRA4001-HF](#) [SKN70/08](#) [SKR70/08](#) [NTE5819](#)  
[NTE5827](#) [NTE5828](#) [NTE5911](#) [NTE5915](#) [NTE6104](#) [NTE6163](#) [NTE6164](#) [NTE6165](#) [NTE6364](#) [TSD3G](#) [SET130312](#) [NRVUS110VT3G](#)  
[UES1106](#) [UES1306](#) [NRVUS240VT3G](#) [D5FE60-5063](#) [R4000GPS-TP](#) [D4015L56TP](#) [UES1306HR2](#)