

## Features

- $V_{DS}=1000V, I_D=15A$
- Low  $C_{rss}$
- Low gate charge
- Improved  $dv/dt$  capability

## Applications

- High efficiency switch mode power supplies
- Electronic lamp ballasts based on half bridge
- UPS

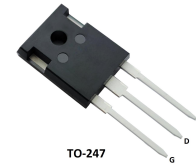
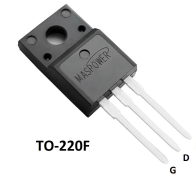
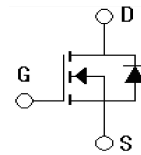

## Absolute Ratings ( $T_c=25^\circ C$ )

Parameter	Symbol	Limit	Unit
Drain-Source Voltage	$V_{DSS}$	1000	V
Gate-Source Voltage	$V_{GSS}$	$\pm 30$	V
Drain Current-continuous	$I_D$ $T_C=25^\circ C$	15	A
	$T_C=100^\circ C$	10	
Drain Current-pulse <sup>(1)</sup>	$I_{DM}$	60	A
Single Pulsed Avalanche Energy ( $T_j=25^\circ C, I_{AR}=4A, V_{DD}=50V$ )	$E_{AS}$	2109	mJ
Maximum Power Dissipation (TO-247)	PD	277	W
		2.22	W/ $^\circ C$
Maximum Power Dissipation (TO-220F)	PD	67.9	W
		0.54	W/ $^\circ C$
Peak Diode Recovery voltage slope <sup>(2)</sup>	$dv/dt$	4.1	V/ns
Operating and Storage Temperature Range	$T_J, T_{STG}$	-55~+175	$^\circ C$

1. Pulse width Limited by safe operating arer

## Electrical Characteristics( $T_{CASE}=25^\circ C$ unless otherwise specified)

Parameter	Symbol	Tests conditions	Min	Typ	Max	Units
Drain-Source Voltage	$BV_{DSS}$	$I_D=250\mu A, V_{GS}=0V$	1000	-	-	V
Zero Gate Voltage Drain Current	$I_{DSS}$	$V_{DS}=V_{DSS}, V_{GS}=0V, T_C=25^\circ C$	-	-	1	$\mu A$
		$T_C=125^\circ C$	-	-	10	$\mu A$
Gate-Body Leakage Current	$I_{GSS}$	$V_{GS}=\pm 30V, V_{DS}=0V$	-	-	$\pm 100$	nA

On-Characteristics						
Gate Threshold Voltage	$V_{GS(th)}$	$V_{DS}=V_{GS}, I_D=250\mu A$	3.0	-	5.0	V
Static Drain-Source On-Resistance	$R_{DS(ON)}$	$V_{GS}=10V, I_D=7.5A$	-	0.90	1.10	$\Omega$
Forward Transconductance	$g_{fs}$	$V_{DS}=40V, I_D=4A$	-	8.5	-	S
Dynamic Characteristics						
Input capacitance	$C_{iss}$	$V_{DS}=25V,$ $V_{GS}=0V,$ $f=1.0MHz$	-	2700	-	pF
Output capacitance	$C_{oss}$		-	210	-	pF
Reverse transfer capacitance	$C_{rss}$		-	30	-	pF

### Electrical Characteristics ( $T_{CASE}=25^\circ C$ unless otherwise specified)

Parameter	Symbol	Tests conditions	Min	Typ	Max	Units
Switching-Characteristics						
Turn-On delay time	$t_{d(on)}$	$V_{DS}=750V, I_D=4A,$ $V_{GS}=10V, R_G=25\Omega$	-	53	-	ns
Turn-On rise time	$t_r$		-	97	-	ns
Turn-Off delay time	$t_{d(off)}$		-	210	-	ns
Turn-Off rise time	$t_f$		-	112	-	ns
Total Gate Charge	$Q_g$	$V_{DS}=750V, I_D=4A,$ $V_{GS}=10V$	-	61	-	nC
Gate-Source charge	$Q_{gs}$		-	22	-	nC
Gate-Drain charge	$Q_{gd}$		-	19	-	nC
Drain-Source Diode Characteristics and Maximum Ratings						
Maximum Continuous Drain-Source Diode Forward Current	$I_{SD}$	$V_{GS}=0V, I_S=15A$	-	-	1.4	V
Diode Forward Current	$I_S$		-	-	15	A
Reverse recovery time	$T_{rr}$	$I_S=4A, di/dT=100A/\mu S$	-	435	-	nS
Reverse recovery charge	$Q_{rr}$	$V_R=100V, V_{GS}=0V,$ $T_j=150^\circ C$	-	2437	-	nC

## Thermal Characteristic

Parameter	Symbol	Value		Unit
		TO-247	TO-220F	
Thermal Resistance, junction to Case	$R_{th(j-C)}$	0.45	1.84	°C/W
Thermal Resistance, junction to Ambient	$R_{th(j-A)}$	40	62.5	°C/W

## Order information

Order codes	Package	Packaging
MS15N100HGC0	TO-247	Tube
MS15N100HGT1	TO-220F	Tube

### Notes:

- 1: Pulse width limited by maximum junction temperature
- 2: L=15mH, IAS=11A, VDD=50V, RG=25 Ω, Starting T<sub>J</sub>=25°C
- 3: ISD ≤11A, di/dt ≤200A/μs, VDD≤BVDSS, Starting T<sub>J</sub>=25°C
- 4: Pulse Test: Pulse Width ≤300μs, Duty Cycle≤2%
- 5: Essentially independent of operating temperature

## Electrical Characteristics

### On-Region Characteristics

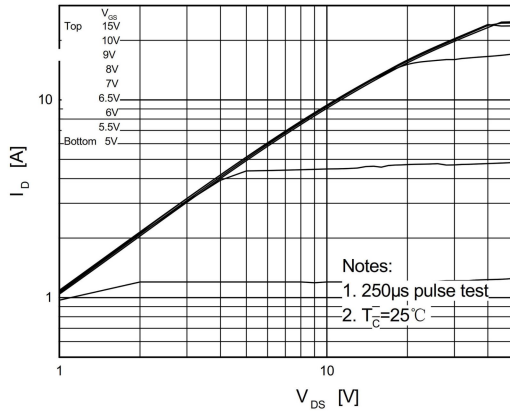

### Transfer Characteristics

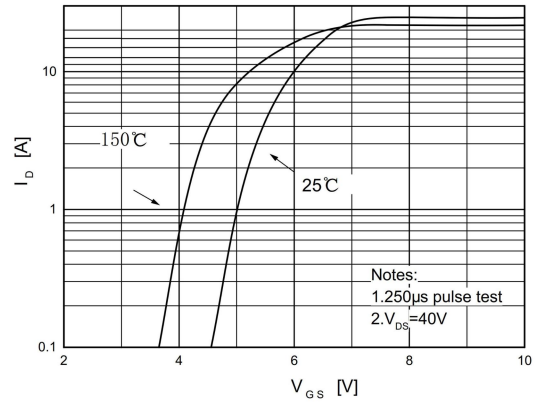

### On-Resistance Variation vs. Drain Current and Gate Voltage

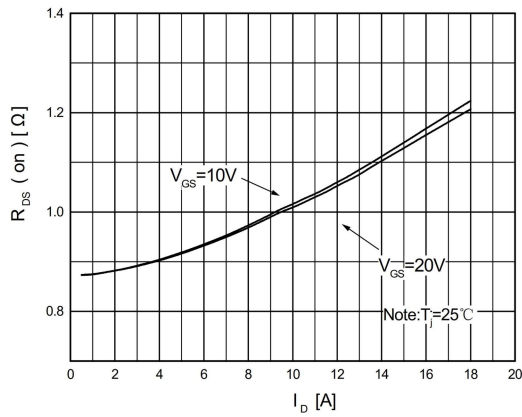

### Body Diode Forward Voltage Variation vs. Source Current and Temperature

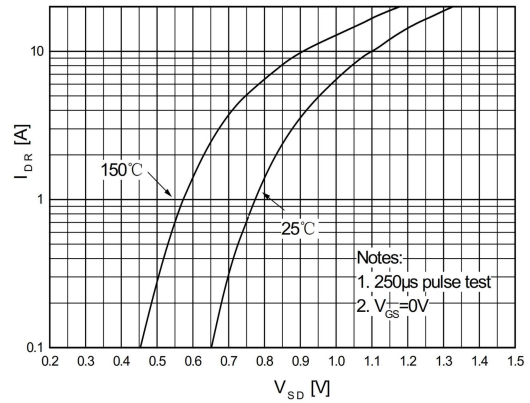

### Capacitance Characteristics

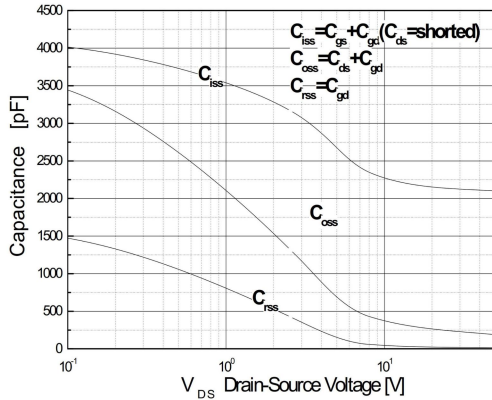

### Gate Charge Characteristics

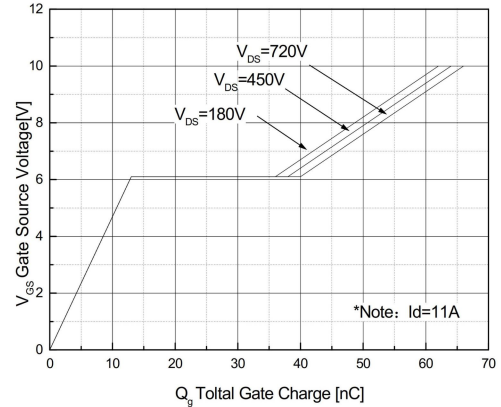

**Breakdown Voltage Variation vs. Temperature**

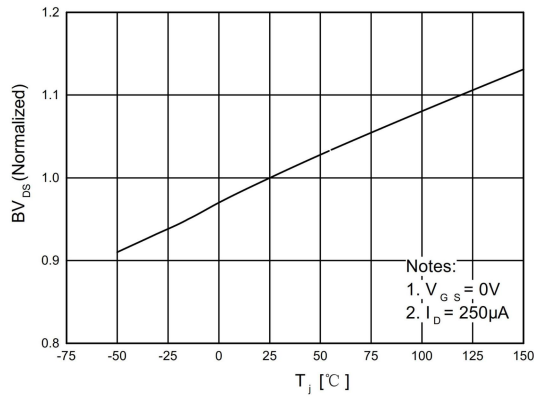

**On-Resistance Variation vs. Temperature**

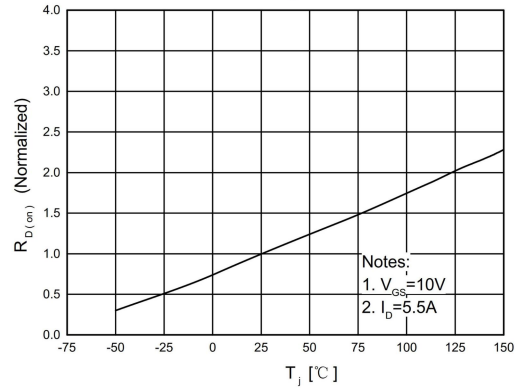

**Maximum Safe Operating Area**

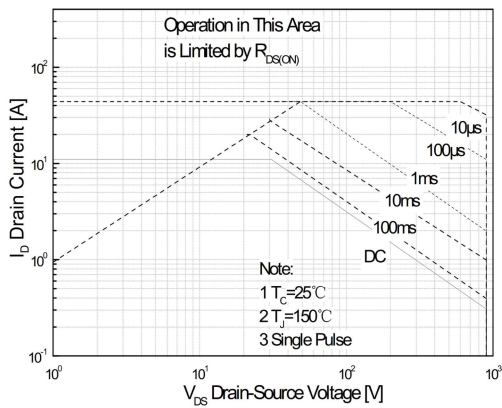

**Maximum Drain Current vs. Case Temperature**

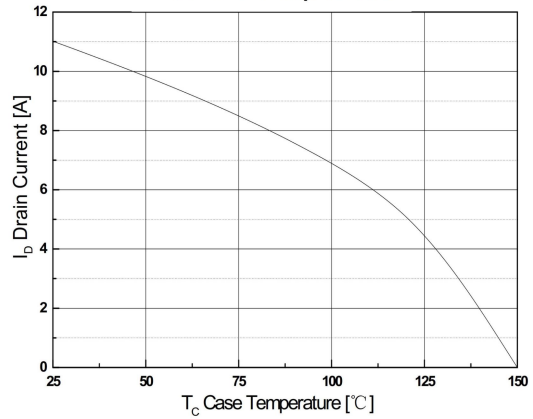

**Transient Thermal Response Curve**

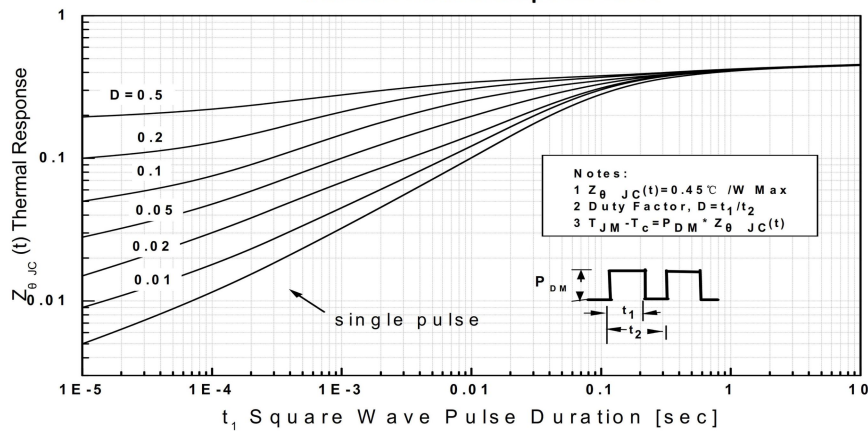

Package Mechanical Data

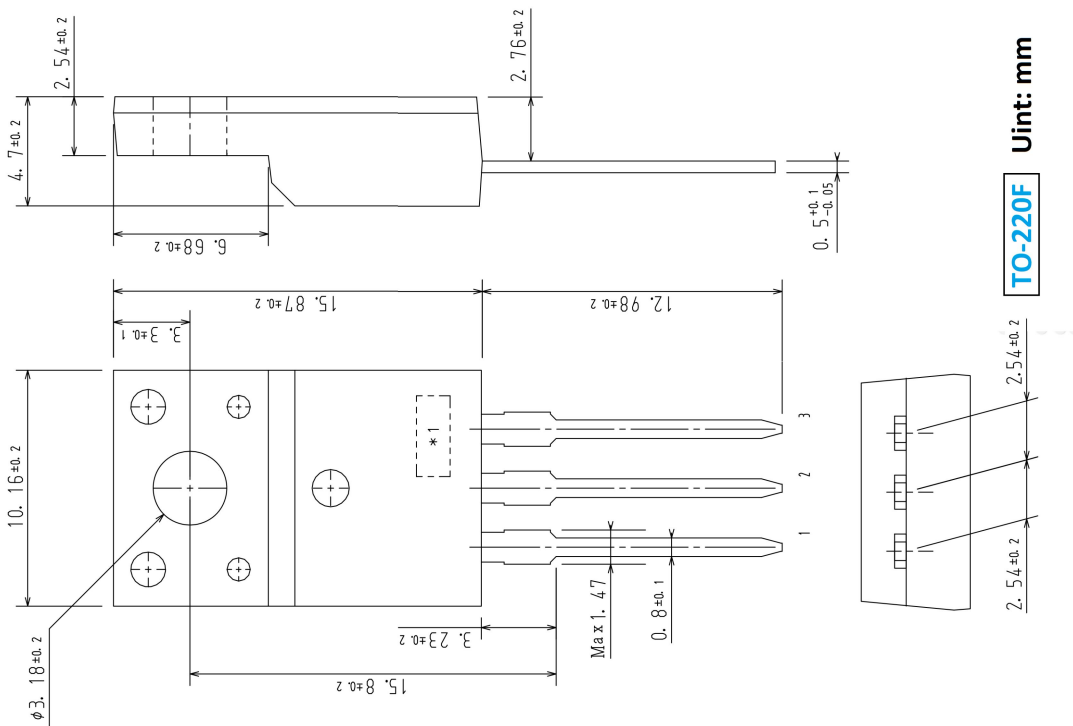
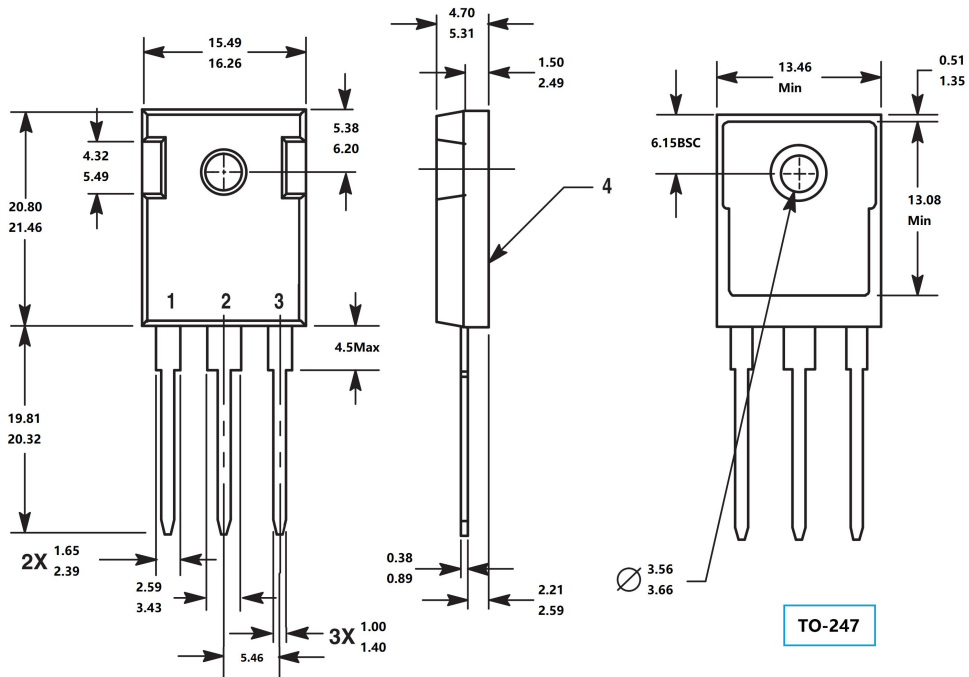

## X-ON Electronics

Largest Supplier of Electrical and Electronic Components

*Click to view similar products for [MOSFET](#) category:*

*Click to view products by [MASPOWER](#) manufacturer:*

Other Similar products are found below :

[IRFD120](#) [IRFY240C](#) [JANTX2N5237](#) [2SK2267\(Q\)](#) [BUK455-60A/B](#) [MIC4420CM-TR](#) [VN1206L](#) [NDP4060](#) [SI4482DY](#)  
[IPS70R2K0CEAKMA1](#) [SQD23N06-31L-GE3](#) [TK16J60W,S1VQ\(O](#) [2SK2614\(TE16L1,Q\)](#) [DMN1017UCP3-7](#) [EFC2J004NUZTDG](#)  
[DMN1053UCP4-7](#) [SQJ469EP-T1-GE3](#) [NTE2384](#) [DMC2700UDMQ-7](#) [DMN2080UCB4-7](#) [DMN61D9UWQ-13](#) [US6M2GTR](#)  
[DMN31D5UDJ-7](#) [DMP22D4UFO-7B](#) [DMN1006UCA6-7](#) [DMN16M9UCA6-7](#) [STF5N65M6](#) [IRF40H233XTMA1](#) [STU5N65M6](#)  
[DMN6022SSD-13](#) [DMN13M9UCA6-7](#) [DMTH10H4M6SPS-13](#) [DMN2990UFB-7B](#) [IPB80P04P405ATMA2](#) [2N7002W-G](#) [MCAC30N06Y-](#)  
[TP](#) [MCQ7328-TP](#) [NTMC083NP10M5L](#) [NVMFS2D3P04M8LT1G](#) [BXP7N65D](#) [BXP4N65F](#) [AOL1454G](#) [WMJ80N60C4](#) [BXP2N20L](#)  
[BXP2N65D](#) [BXT1150N10J](#) [BXT1700P06M](#) [TSM60NB380CP](#) [ROG](#) [RQ7L055BGTCR](#) [DMNH15H110SK3-13](#)