

Features

- 100% avalanche tested
- Avalanche ruggedness
- Very low intrinsic capacitances
- High speed switching
- Very low on-resistance

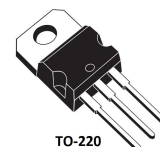

TO-220F

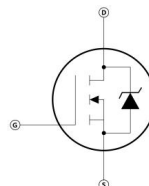

TO-220

Applications

- Welder
- UPS
- PV Inverter
- Switching applications

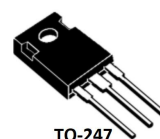

TO-247

Electrical ratings

Absolute maximum ratings				
Parameter	Symbol	Value	Unit	
Drain-source voltage ($V_{GS} = 0$)	V_{DS}	1200	V	
Gate- source voltage	V_{GS}	± 20		
Drain current (continuous) at $T_C = 25\text{ }^\circ\text{C}$	I_D	6	A	
Drain current (continuous) at $T_C = 100\text{ }^\circ\text{C}$		3.8		
Drain current (pulsed)	I_{DM}	12		
Total dissipation at $T_C = 25\text{ }^\circ\text{C}$ (TO-247/TO-220)	P_{TOT}	160	W	
Total dissipation at $T_C = 25\text{ }^\circ\text{C}$ (TO-220F)	P_{TOT}	33	W	
Derating factor(TO-247/TO-220)		1.28	W/ $^\circ\text{C}$	
Derating factor(TO-220F)		0.26	W/ $^\circ\text{C}$	
Operating junction temperature	T_J	-55 to 175	$^\circ\text{C}$	
Storage temperature	T_{stg}			
Thermal data				
Parameter	Symbol	Value		Unit
		TO-247 TO-220	TO-220F	
Thermal resistance junction-case max	$R_{thj-case}$	0.78	3.79	W/ $^\circ\text{C}$
Thermal resistance junction-ambient max	$R_{thj-amb}$	76	84	
Maximum lead temperature for soldering purpose	T_J	300		

Avalanche characteristics			
Parameter	Symbol	Max value	Unit
Avalanche current, repetitive or not-repetitive (pulse width limited by T_J max)	I_{AR}	2.1	A
Single pulse avalanche energy (starting $T_J = 25\text{ }^\circ\text{C}$, $I_D = I_{AR}$, $V_{DD} = 50\text{ V}$)	E_{AS}	753	mJ

Electrical Characteristics ($T_{vj} = 25^\circ\text{C}$ unless otherwise specified)

On /off states						
Parameter	Symbol	Test conditions	Min	Typ	Max	Unit
Drain-source breakdown voltage	$V_{(BR)DSS}$	$I_D = 1\text{ mA}$, $V_{GS} = 0$	1200			V
Zero gate voltage drain current ($V_{GS} = 0$)	I_{DSS}	$V_{DS} = \text{Max rating}$ $V_{DS} = \text{Max rating}$, $T_C = 125\text{ }^\circ\text{C}$			66	μA
Gate-body leakage current ($V_{DS} = 0$)	I_{GSS}	$V_{GS} = \pm 30\text{ V}$			± 100	nA
Gate threshold voltage	$V_{GS(th)}$	$V_{DS} = V_{GS}$, $I_D = 250\text{ }\mu\text{A}$	3	4	5	V
Static drain-source on resistance	$R_{DS(on)}$	$V_{GS} = 10\text{V}$, $I_D = 4\text{A}$		5.5	7	Ω
Dynamic						
Parameter	Symbol	Test conditions	Min	Typ	Max	Unit
Forward transconductance	g_{fs}	$V_{DS} = 15\text{ V}$, $I_D = 4$		5.7		S
Input capacitance	C_{iss}	$V_{DS} = 25\text{V}$, $f = 1\text{MHz}$, $V_{GS} = 0$		2310		pF
Output capacitance	C_{oss}			330		
Reverse transfer capacitance	C_{rss}			80		
Equivalent Output capacitance	$C_{oss\text{ eq.}}$	$V_{GS} = 0$, $V_{DS} = 0$ to 1200V		120		
Gate input resistance	R_g	$f = 1\text{MHz}$ Gate DC Bias = 0 Test signal level = 20mV open drain		2.2		Ω
Total gate charge	Q_g	$V_{DD} = 1200\text{V}$, $I_D = 8\text{A}$ $V_{GS} = 10\text{V}$		85		nC
Gate-source charge	Q_{gs}			14		
Gate-drain charge	Q_{gd}			48		
Switching times						
Parameter	Symbol	Test conditions	Min	Typ	Max	Unit
Turn-on delay time	$t_{d(on)}$	$V_{DD} = 750\text{ V}$, $I_D = 4\text{ A}$,		33		ns

Rise time	t_r	$R_G = 4.7 \Omega, V_{GS} = 10 V$		26		
Turn-off-delay time	$t_{d(off)}$			46		
Fall time	t_f			21		
Source drain diode						
Parameter	Symbol	Test conditions	Min	Typ	Max	Unit
Source-drain current	I_{SD}			6		A
Source-drain current (pulsed)	I_{SDM}			12		
Forward on voltage	V_{SD}	$I_{SD} = 6A, V_{GS} = 0$		1.5		V
Reverse recovery time	t_{rr}	$I_{SD} = 6A, di/dt = 100A/\mu s$ $V_{DD} = 60 V$		360		nS
Reverse recovery charge	Q_{rr}			5.3		μC
Reverse recovery current	I_{RRM}			19		A
Reverse recovery time	t_{rr}	$I_{SD} = 6A, di/dt = 100A/\mu s$ $V_{DD} = 60V T_J = 150^\circ C$		520		nS
Reverse recovery charge	Q_{rr}			7.6		μC
Reverse recovery current	I_{RRM}			17		A

Order information

MS6N120FS	TO-220F	Tube	
MS6N120FT	TO-220	Tube	
MS6N120FC	TO-247	Tube	

Electrical characteristics

1. Output Characteristics @ 25°C

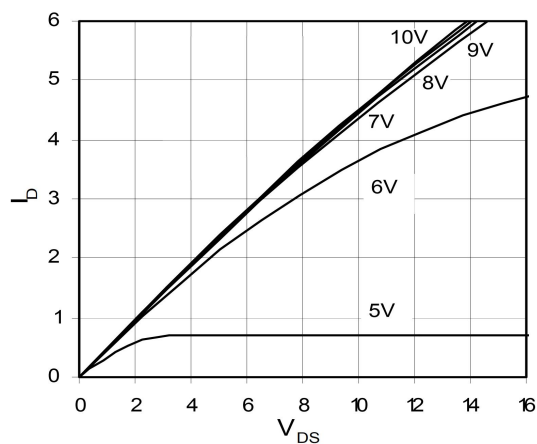

2. Extended Output Characteristics @ 25°C

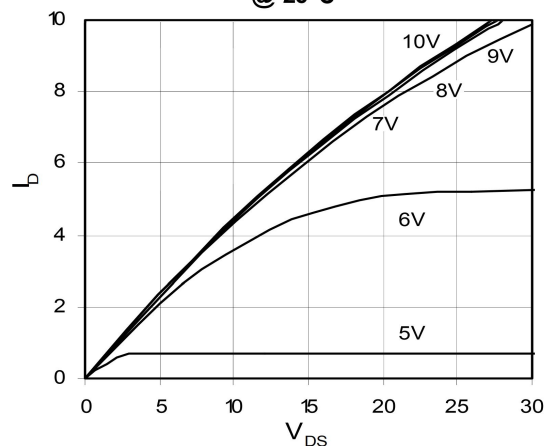

3. Output Characteristics @ 125 °C

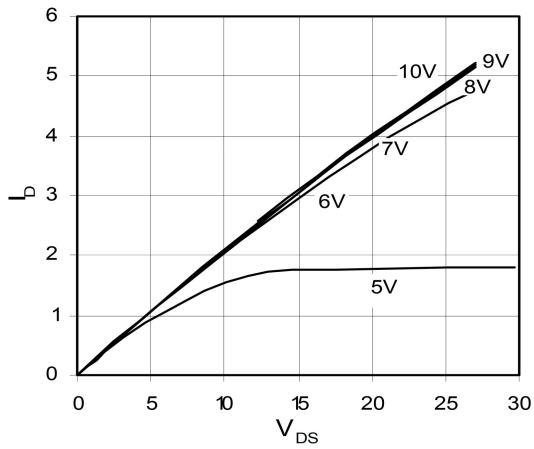

4. $R_{DS(on)}$ Normalized to I_D Value vs. Junction Temperature

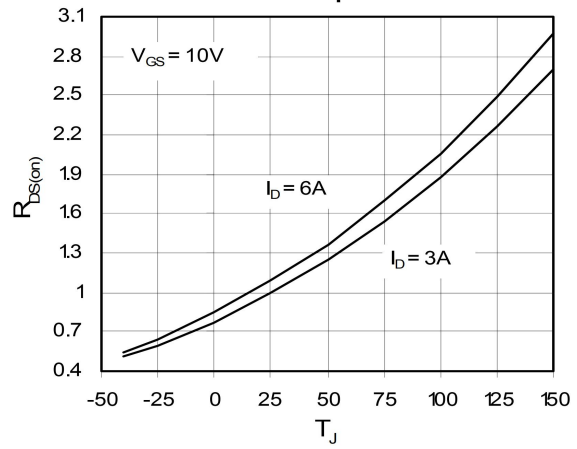

5. $R_{DS(on)}$ Normalized to I_D Value vs. I_D

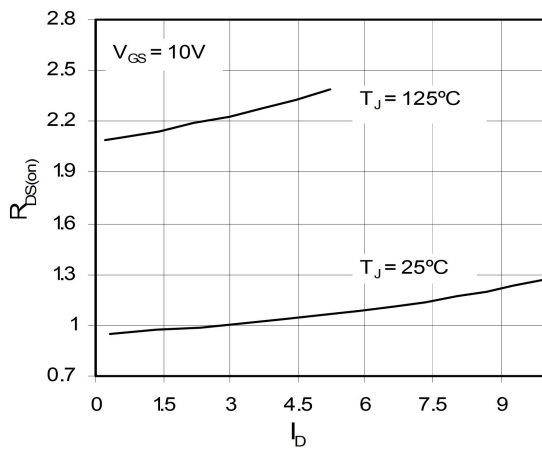

6. Drain Current vs. Case Temperature

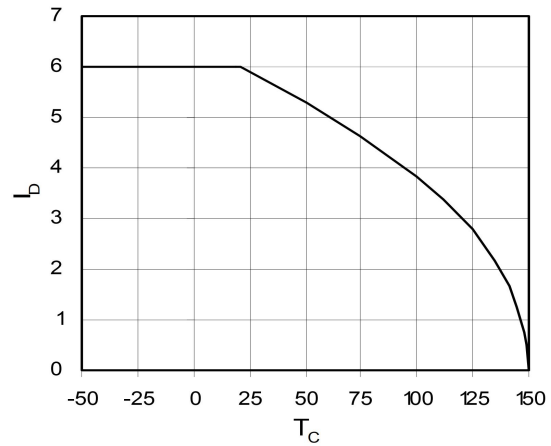

7. Input Admittance

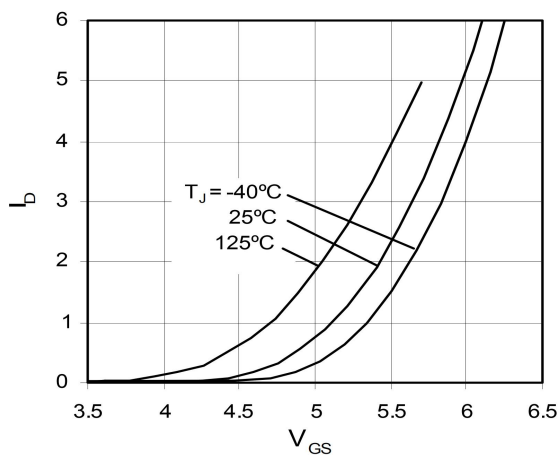

8. Transconductance

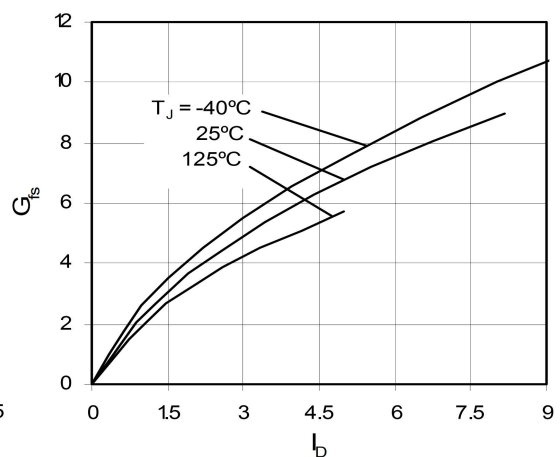

9. Source Current vs. Source-To-Drain

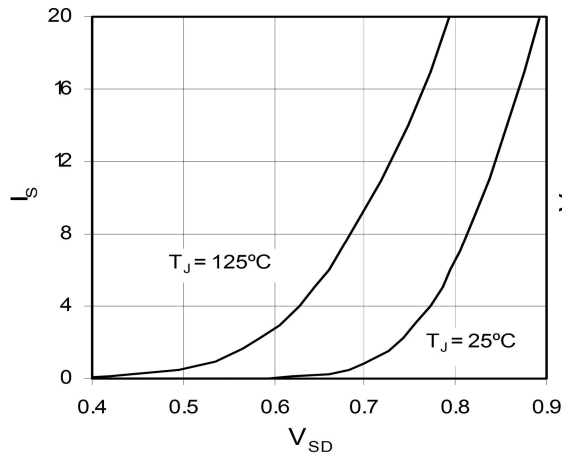

10. Gate Charge

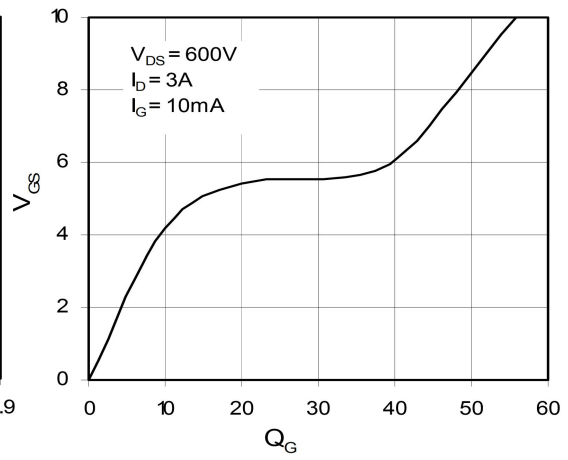

11. Capacitance

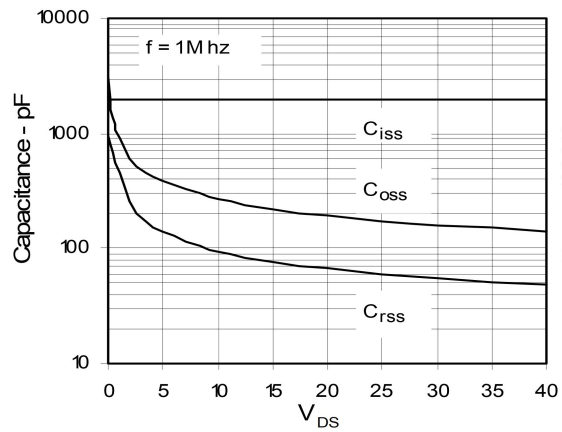

12. Maximum Transient Thermal Resistance

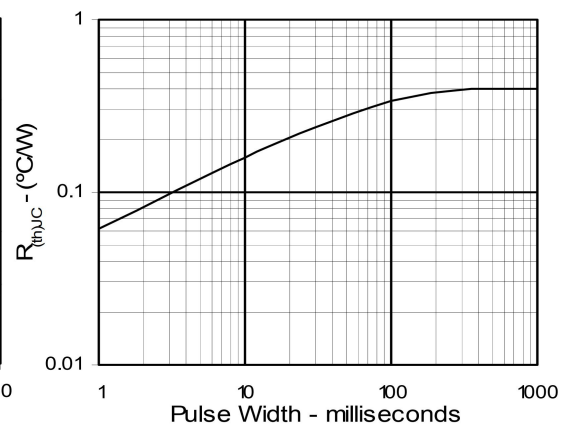

Package outline dimension

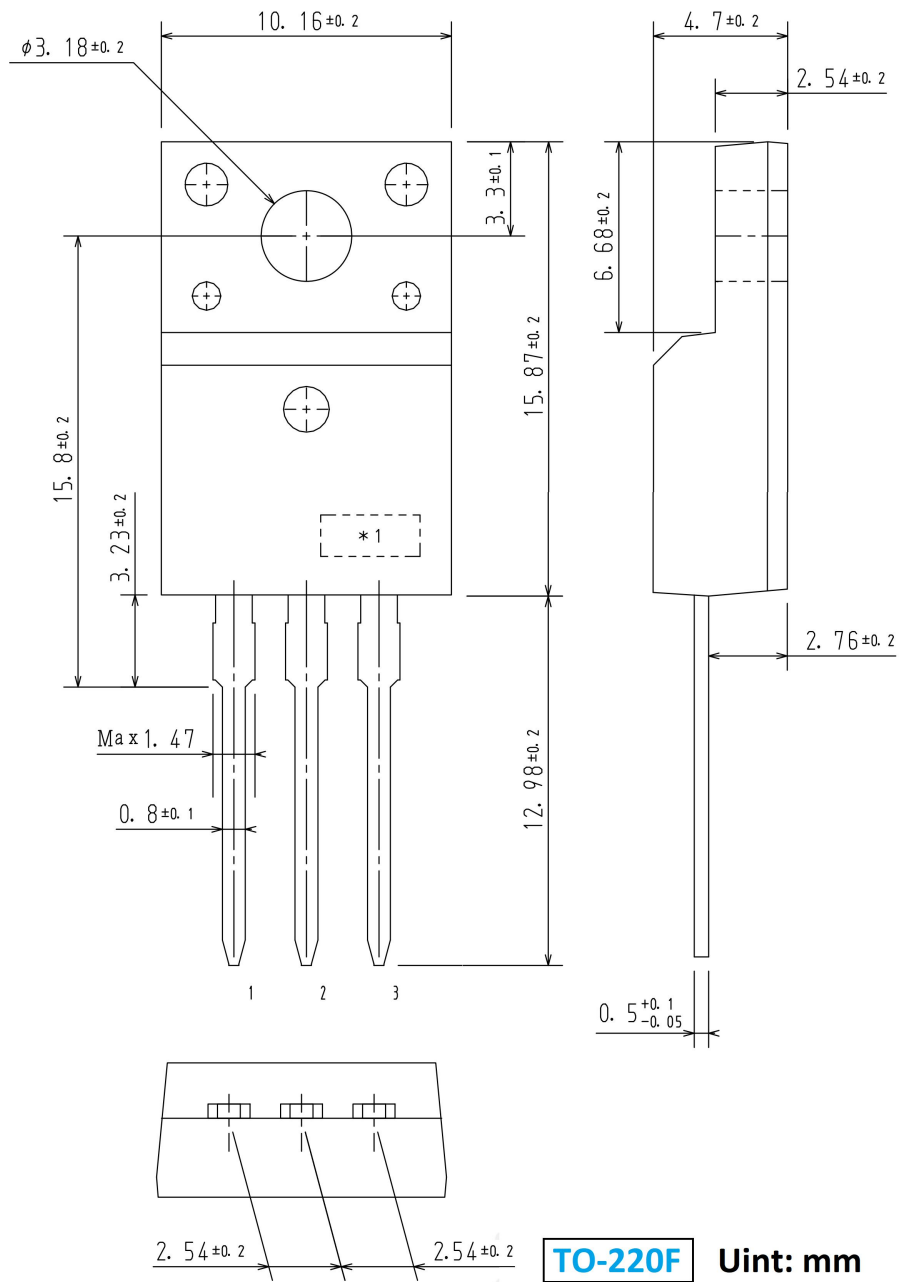

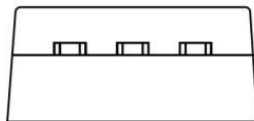
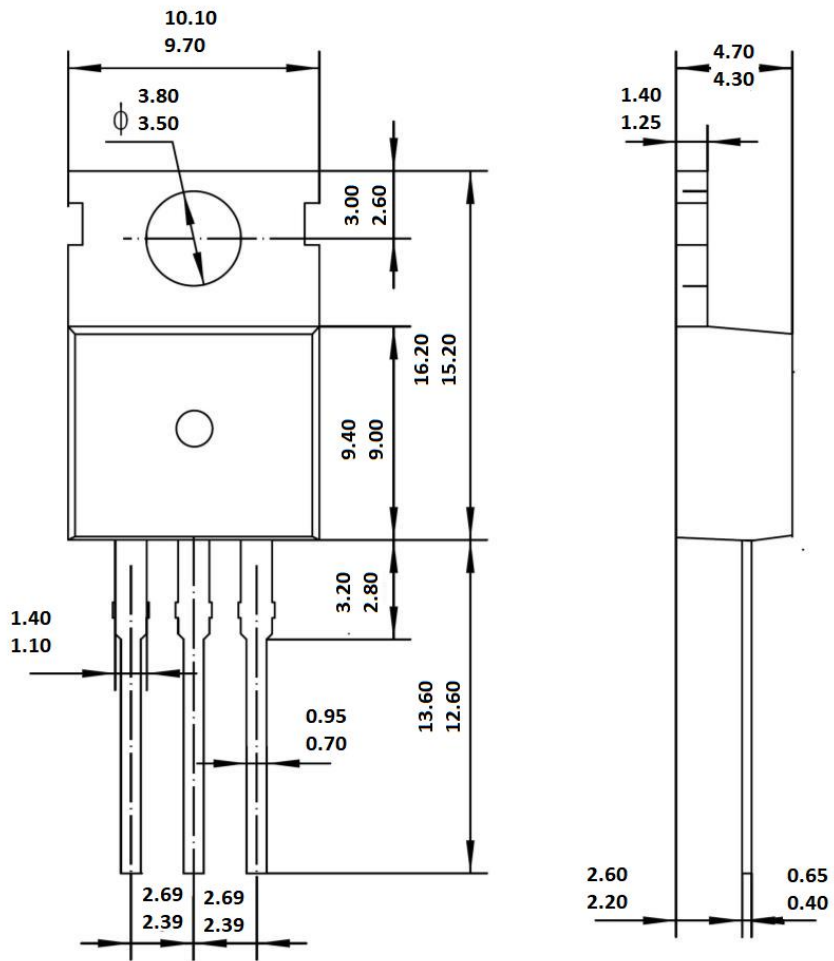

TO-220

Unit: mm

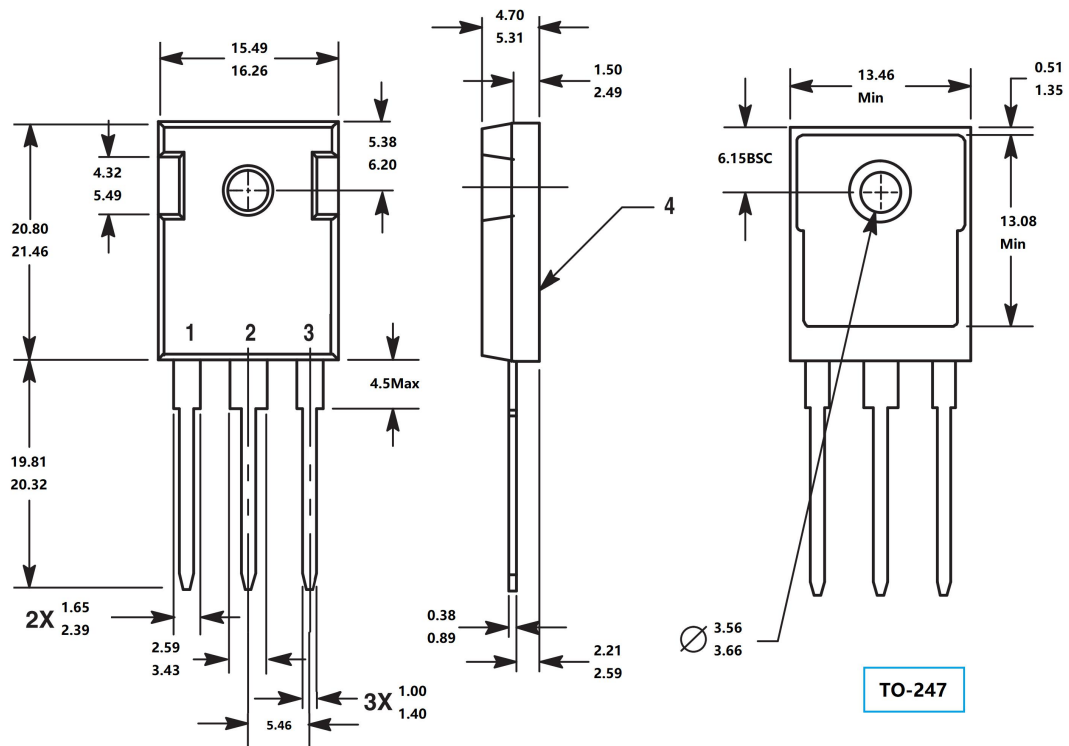

X-ON Electronics

Largest Supplier of Electrical and Electronic Components

Click to view similar products for [MOSFET](#) category:

Click to view products by [MASPOWER](#) manufacturer:

Other Similar products are found below :

[IRFD120](#) [IRFY240C](#) [JANTX2N5237](#) [BUK455-60A/B](#) [MIC4420CM-TR](#) [VN1206L](#) [NDP4060](#) [SI4482DY](#) [IPS70R2K0CEAKMA1](#)
[SQD23N06-31L-GE3](#) [TK16J60W,S1VQ\(O](#) [2SK2614\(TE16L1,Q\)](#) [DMN1017UCP3-7](#) [EFC2J004NUZTDG](#) [DMN1053UCP4-7](#) [SQJ469EP-](#)
[T1-GE3](#) [NTE2384](#) [DMC2700UDMQ-7](#) [DMN2080UCB4-7](#) [DMN61D9UWQ-13](#) [US6M2GTR](#) [DMN31D5UDJ-7](#) [DMP22D4UFO-7B](#)
[DMN1006UCA6-7](#) [DMN16M9UCA6-7](#) [STF5N65M6](#) [IRF40H233XTMA1](#) [STU5N65M6](#) [DMN6022SSD-13](#) [DMN13M9UCA6-7](#)
[DMTH10H4M6SPS-13](#) [DMN2990UFB-7B](#) [IPB80P04P405ATMA2](#) [2N7002W-G](#) [MCAC30N06Y-TP](#) [MCQ7328-TP](#) [NTMC083NP10M5L](#)
[NVMFS2D3P04M8LT1G](#) [BXP7N65D](#) [BXP4N65F](#) [AOL1454G](#) [WMJ80N60C4](#) [BXP2N20L](#) [BXP2N65D](#) [BXT1150N10J](#) [BXT1700P06M](#)
[TSM60NB380CP](#) [ROG](#) [RQ7L055BGTCR](#) [DMNH15H110SK3-13](#) [SLF10N65ABV2](#)