

### Features

- 100% avalanche tested
- Avalanche ruggedness
- Gate charge minimized
- Very low intrinsic capacitances
- High speed switching
- Very low on-resistance

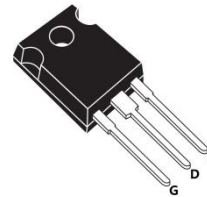

### General Description

### Applications

- Welder
- UPS
- PV Inverter
- Switching applications

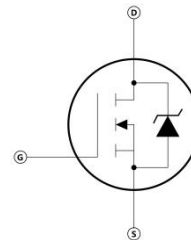

### Electrical ratings

Absolute maximum ratings			
Parameter	Symbol	Value	Unit
Drain-source voltage ( $V_{GS} = 0$ )	$V_{DS}$	1500	V
Gate- source voltage	$V_{GS}$	$\pm 30$	
Drain current (continuous) at $T_C = 25\text{ }^\circ\text{C}$	$I_D$	9	A
Drain current (continuous) at $T_C = 100\text{ }^\circ\text{C}$		6	
Drain current (pulsed)		$I_{DM}$	
Total dissipation at $T_C = 25\text{ }^\circ\text{C}$	$P_{TOT}$	350	W
Derating factor		2.56	W/ $^\circ\text{C}$
Operating junction temperature	$T_J$	-55 to 150	$^\circ\text{C}$
Storage temperature	$T_{stg}$		

Thermal data			
Parameter	Symbol	Value	Unit
Thermal resistance junction-case max	$R_{thj-case}$	0.39	W/ $^\circ\text{C}$
Thermal resistance junction-ambient max	$R_{thj-amb}$	50	
Maximum lead temperature for soldering purpose	$T_J$	300	

<b>Avalanche characteristics</b>			
<b>Parameter</b>	<b>Symbol</b>	<b>Max value</b>	<b>Unit</b>
Avalanche current, repetitive or not-repetitive (pulse width limited by $T_J$ max)	$I_{AR}$	8	A
Single pulse avalanche energy (starting $T_J = 25\text{ }^\circ\text{C}$ , $I_D = I_{AR}$ , $V_{DD} = 50\text{ V}$ )	$E_{AS}$	800	mJ

**Electrical Characteristics ( $T_{vj} = 25^\circ\text{C}$  unless otherwise specified)**

<b>On /off states</b>						
<b>Parameter</b>	<b>Symbol</b>	<b>Test conditions</b>	<b>Min</b>	<b>Typ</b>	<b>Max</b>	<b>Unit</b>
Drain-source breakdown voltage	$V_{(BR)DSS}$	$I_D = 1\text{ mA}$ , $V_{GS} = 0$	1500			V
Zero gate voltage drain current ( $V_{GS} = 0$ )	$I_{DSS}$	$V_{DS} = \text{Max rating}$ $V_{DS}=\text{Max rating}$ , $T_C=125\text{ }^\circ\text{C}$			10 500	$\mu\text{A}$
Gate-body leakage current ( $V_{DS} = 0$ )	$I_{GSS}$	$V_{GS} = \pm 30\text{ V}$			$\pm 100$	nA
Gate threshold voltage	$V_{GS(th)}$	$V_{DS} = V_{GS}$ , $I_D = 250\text{ }\mu\text{A}$	3	4	5	V
Static drain-source on resistance	$R_{DS(on)}$	$V_{GS} = 10\text{V}$ , $I_D = 4\text{A}$	-	2.9	3.5	$\Omega$

<b>Dynamic</b>						
<b>Parameter</b>	<b>Symbol</b>	<b>Test conditions</b>	<b>Min</b>	<b>Typ</b>	<b>Max</b>	<b>Unit</b>
Forward transconductance	$g_{fs}$	$V_{DS} = 15\text{ V}$ , $I_D = 4$		7		S
Input capacitance	$C_{iss}$	$V_{DS}=25\text{V}$ , $f=1\text{MHz}$ , $V_{GS}=0$		3150		pF
Output capacitance	$C_{oss}$			300		
Reverse transfer capacitance	$C_{rss}$			25		
Equivalent Output capacitance	$C_{oss\text{ eq.}}$	$V_{GS}=0$ , $V_{DS}=0$ to $1200\text{V}$		120		
Gate input resistance	$R_g$	$f=1\text{MHz}$ Gate DC Bias=0 Test signal level=20mV open drain		2.2		$\Omega$
Total gate charge	$Q_g$	$V_{DD}=1200\text{V}$ , $I_D=8\text{A}$ $V_{GS}=10\text{V}$		85		nC
Gate-source charge	$Q_{gs}$			14		
Gate-drain charge	$Q_{gd}$			48		

Switching times						
Parameter	Symbol	Test conditions	Min	Typ	Max	Unit
Turn-on delay time	$t_{d(on)}$	$V_{DD} = 750\text{ V}, I_D = 4\text{ A},$ $R_G = 4.7\ \Omega, V_{GS} = 10\text{ V}$		50		ns
Rise time	$t_r$			16		
Turn-off-delay time	$t_{d(off)}$			100		
Fall time	$t_f$			80		

Source drain diode						
Parameter	Symbol	Test conditions	Min	Typ	Max	Unit
Source-drain current	$I_{SD}$			8		A
Source-drain current (pulsed)	$I_{SDM}$			40		
Forward on voltage	$V_{SD}$	$I_{SD} = 8\text{ A}, V_{GS} = 0$		1.5		V
Reverse recovery time	$t_{rr}$	$I_{SD} = 8\text{ A}, di/dt = 100\text{ A}/\mu\text{s}$ $V_{DD} = 60\text{ V}$		950		
Reverse recovery charge	$Q_{rr}$			9		
Reverse recovery current	$I_{RRM}$			20		
Reverse recovery time	$t_{rr}$	$S_D = 8\text{ A}, di/dt = 100\text{ A}/\mu\text{s}$ $V_{DD} = 60\text{ V}, T_J = 150^\circ\text{C}$		900		
Reverse recovery charge	$Q_{rr}$			8.5		
Reverse recovery current	$I_{RRM}$			19		

## Electrical characteristics

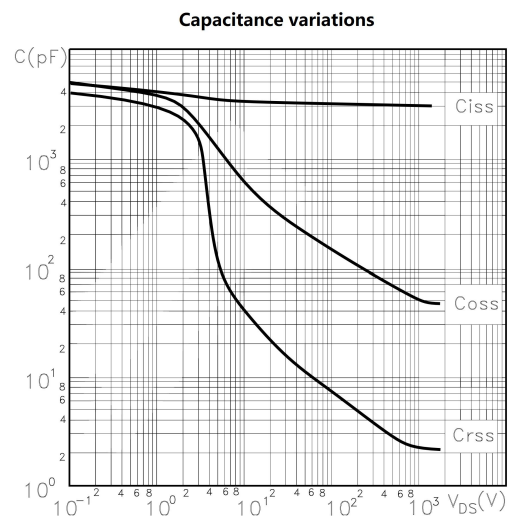
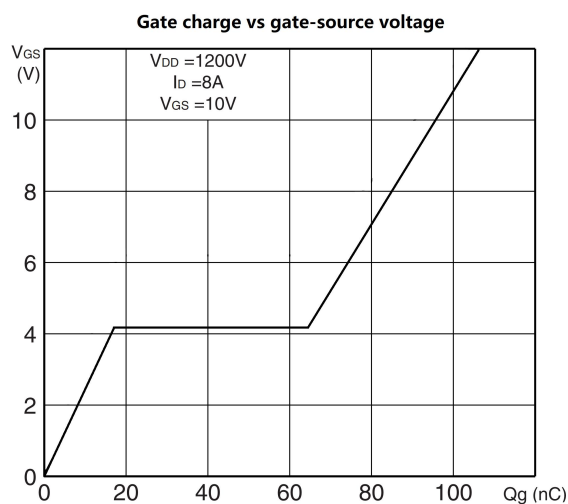

**Normalized BVDSS vs temperature**

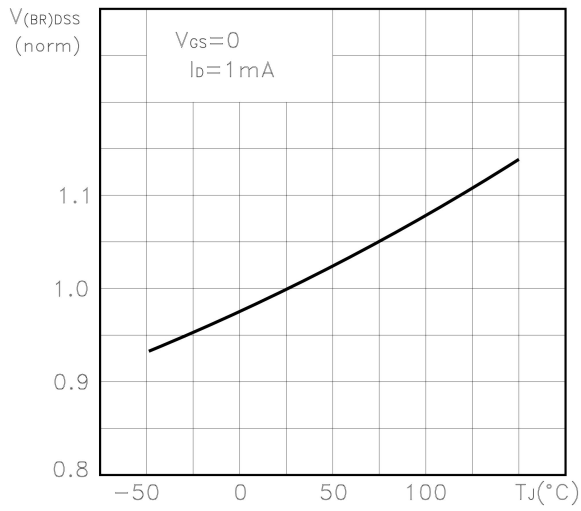

**Static drain-source on resistance**

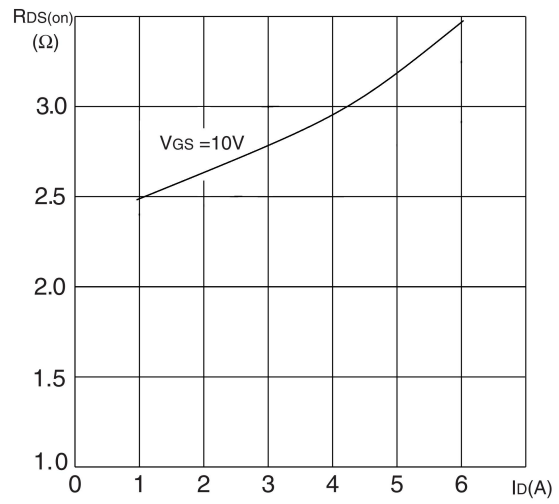

**Output characteristics**

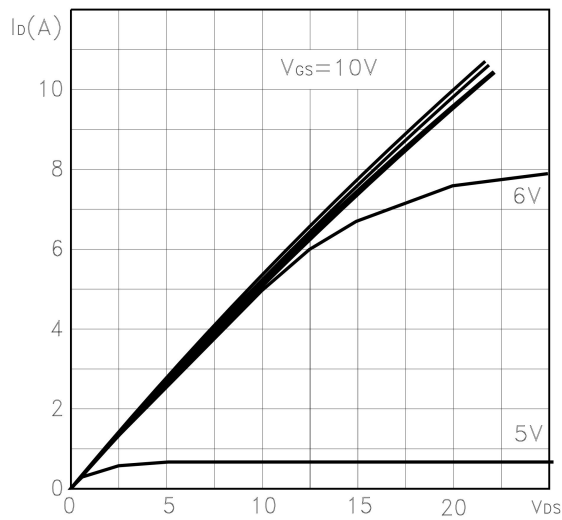

**Transfer characteristics**

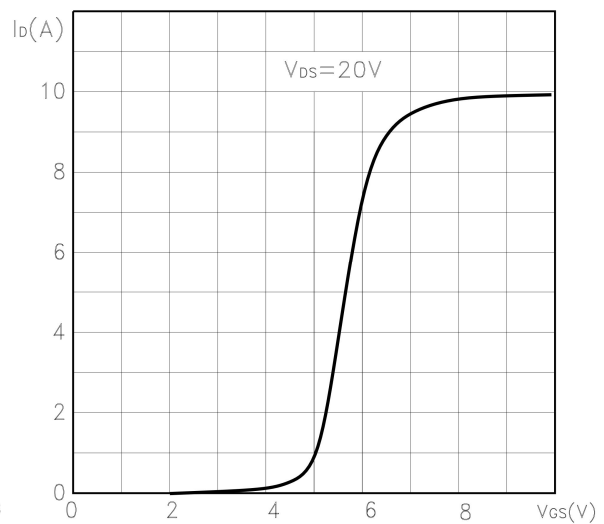

**Normalized gate threshold voltage vs temperature**

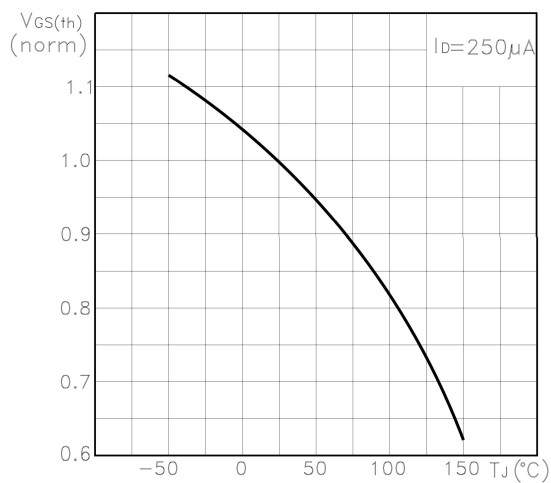

**Normalized on resistance vs temperature**

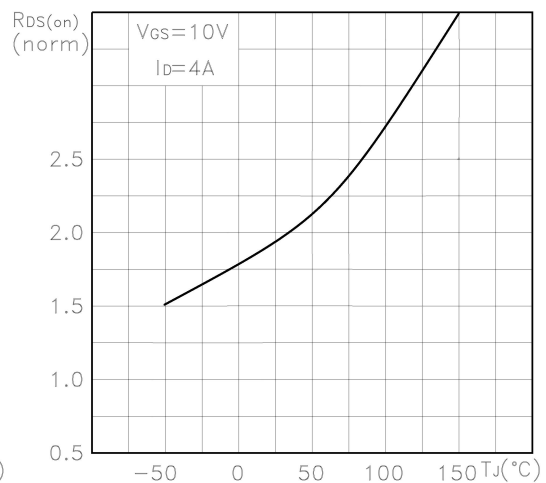

Gate charge vs gate-source voltage

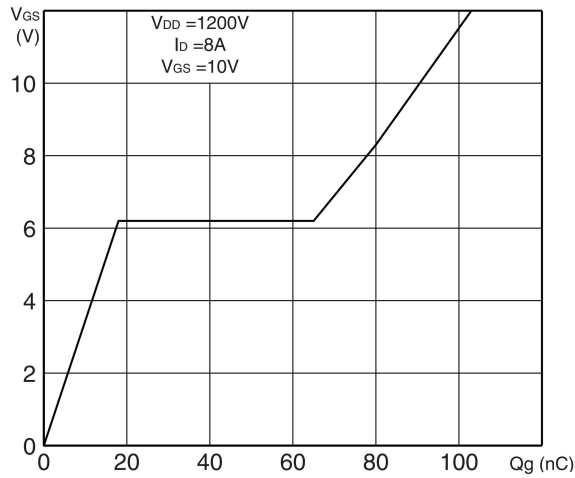

Capacitance variations

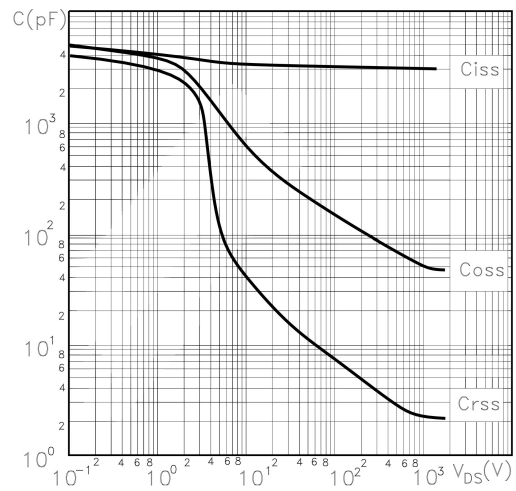

Source-drain diode forward characteristics

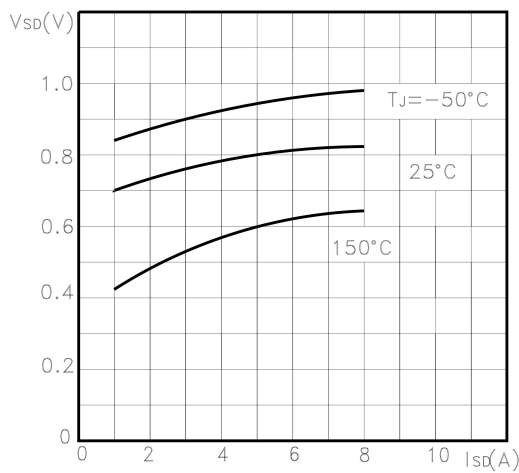

Maximum avalanche energy vs temperature

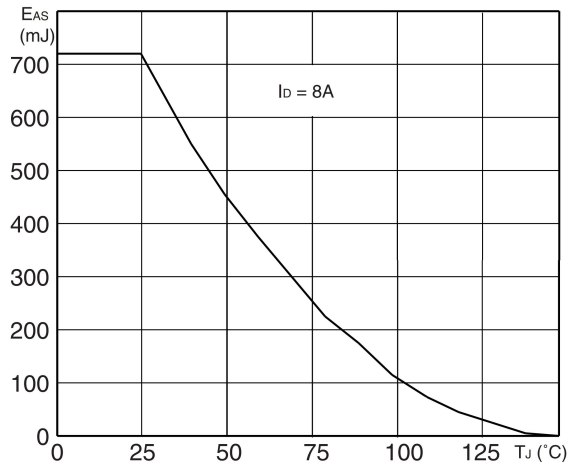

Safe operating area

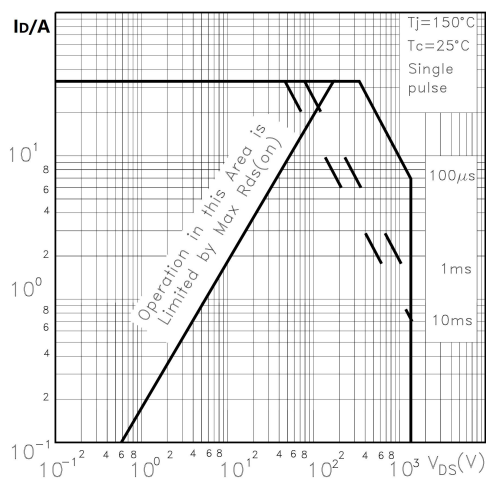

Thermal impedance

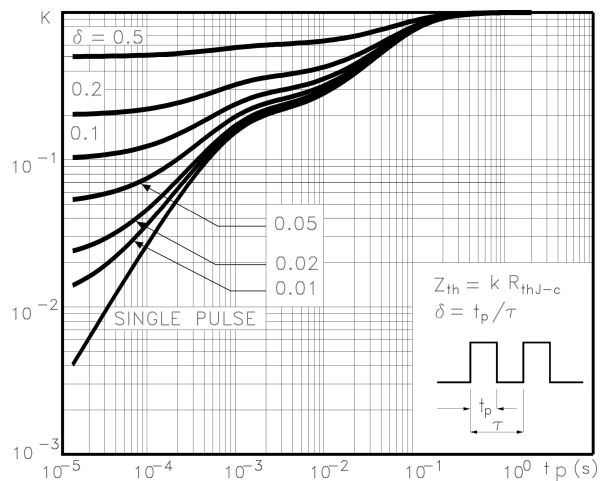

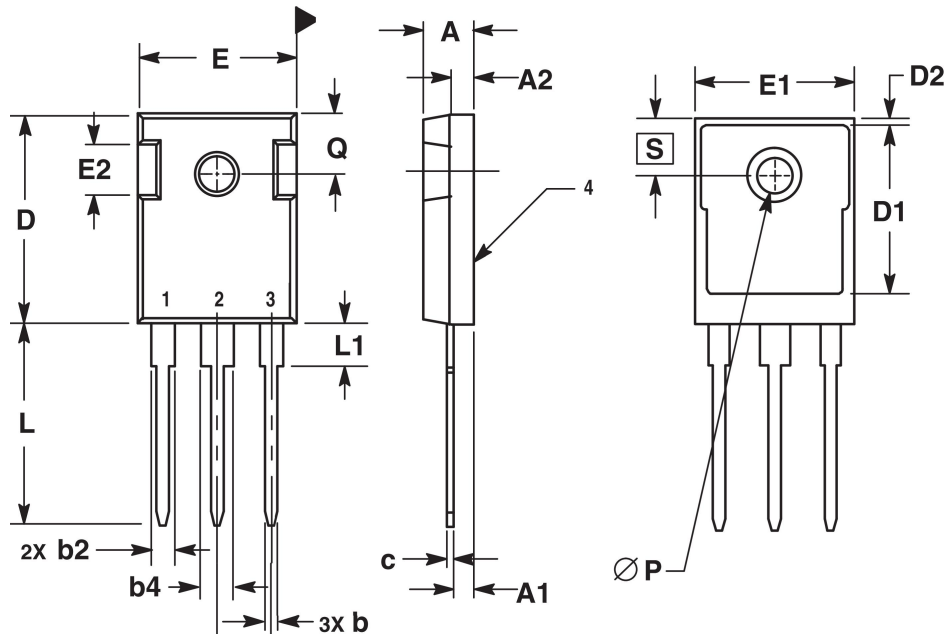
**Package outline dimension**
**TO-247**

Symbol	Min	Max	Unit
A	4.7	5.31	mm
A1	2.21	2.59	
A2	1.5	2.49	
b	1	1.4	
b2	1.65	2.39	
b4	2.59	3.43	
c	0.38	0.89	
D	20.8	21.46	
D1	13.08	-	
D2	0.51	1.35	
E	15.49	16.26	
E1	13.46	-	
E2	4.32	5.49	
e	5.46BSC		
L	19.81	20.32	
L1	-	4.5	
P	3.56	3.66	
Q	5.38	6.2	
S	6.15BSC		

## X-ON Electronics

Largest Supplier of Electrical and Electronic Components

*Click to view similar products for [MOSFET](#) category:*

*Click to view products by [MASPOWER](#) manufacturer:*

Other Similar products are found below :

[IRFD120](#) [IRFY240C](#) [JANTX2N5237](#) [BUK455-60A/B](#) [MIC4420CM-TR](#) [VN1206L](#) [NDP4060](#) [SI4482DY](#) [IPS70R2K0CEAKMA1](#)  
[SQD23N06-31L-GE3](#) [TK16J60W,S1VQ\(O](#) [2SK2614\(TE16L1,Q\)](#) [DMN1017UCP3-7](#) [EFC2J004NUZTDG](#) [DMN1053UCP4-7](#) [SQJ469EP-](#)  
[T1-GE3](#) [NTE2384](#) [DMC2700UDMQ-7](#) [DMN2080UCB4-7](#) [DMN61D9UWQ-13](#) [US6M2GTR](#) [DMN31D5UDJ-7](#) [DMP22D4UFO-7B](#)  
[DMN1006UCA6-7](#) [DMN16M9UCA6-7](#) [STF5N65M6](#) [IRF40H233XTMA1](#) [STU5N65M6](#) [DMN6022SSD-13](#) [DMN13M9UCA6-7](#)  
[DMTH10H4M6SPS-13](#) [DMN2990UFB-7B](#) [IPB80P04P405ATMA2](#) [2N7002W-G](#) [MCAC30N06Y-TP](#) [MCQ7328-TP](#) [NTMC083NP10M5L](#)  
[NVMFS2D3P04M8LT1G](#) [BXP7N65D](#) [BXP4N65F](#) [AOL1454G](#) [WMJ80N60C4](#) [BXP2N20L](#) [BXP2N65D](#) [BXT1150N10J](#) [BXT1700P06M](#)  
[TSM60NB380CP](#) [ROG](#) [RQ7L055BGTCR](#) [DMNH15H110SK3-13](#) [SLF10N65ABV2](#)