

Features

- Low gate charge
- Trench FS Technology,
- saturation voltage: $V_{CE(sat)}$,
typ = 1.6V, $I_C=20A$ and $T_C = 25^\circ C$
- RoHS product

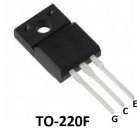

TO-220F

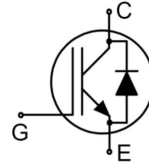
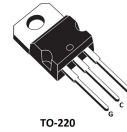

TO-220

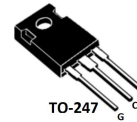

TO-247

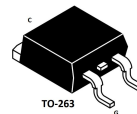

TO-263

Applications

- General purpose inverters
- UPS

Absolute Ratings ($T_C=25^\circ C$)

Parameter	Symbol	MSG20T65FQS	MSG20T65FQT/ MSG20T65FQE	MSG20T65FQC	Unit
Collector-Emmitter Voltage	V_{ces}	650			V
Collector Current-continuous	I_C $T=25^\circ C$ $T=100^\circ C$	40			A
		20			A
Collector Current-pulse(note 1)	I_{CM}	80			A
Diode RMS forward current	I_F $T=25^\circ C$ $T=100^\circ C$	40			A
		20			A
Gate-Emmitter Voltage	V_{GES}	± 20			V
Turn-off safe area	-	180			A
Surge non repetitive forward current $t_p=10ms$ sinusoidal	I_{FSM}	80			A
Power Dissipation	P_D $T_C=25^\circ C$	35	156	162	W
Diode Forward Current	$T_C=100^\circ C$	20			A
Storage Temperature Range	T_{STG}	-55~+150			$^\circ C$
Operating Temperature Range	T_J	-55~+175			$^\circ C$
Maximum Lead Temperature for Soldering Purposes	T_L	300			$^\circ C$

*Collector current limited by maximum Junction temperature

Thermal Characteristic

Parameter	Symbol	Tests conditions	Min	Typ	Max	Units
Off-Characteristics						
Collector-Emmitter Voltage	BV_{CES}	$I_C=500\mu A, V_{GE}=0V$	650	-	-	V

Breakdown Voltage Temperature Coefficient	$\Delta BV_{CES}/\Delta T_J$	$I_C=1\text{mA}$, referenced to 25°C	-	0.5	-	$\text{V}/^\circ\text{C}$
Zero Gate Voltage Collector Current	I_{CES}	$V_{CE}=650\text{V}$, $V_{GE}=0\text{V}$, $T_C=25^\circ\text{C}$	-		10	μA
Gate-body leakage current	I_{GES}	$V_{CE}=0\text{V}$, $V_{GE}=\pm 20\text{V}$	-	-	± 200	nA
On-Characteristics						
Gate-Emmitter Threshold Voltage	$V_{GE(th)}$	$V_{CE}=V_{GE}$, $I_C=250\mu\text{A}$	4.5	-	6.5	V
Collector-Emmitter saturation Voltage	V_{CESAT}	$V_{GE}=15\text{V}$, $I_C=20\text{A}$, $T_C=25^\circ\text{C}$	-	1.6	2.0	V
		$T_C=125^\circ\text{C}$		1.75	2.15	
		$T_C=175^\circ\text{C}$		1.9	2.3	
Short Collector current	$I_C(sc)$	$V_{GE}=15\text{V}$ $V_{CE}=360\text{V}$ $t_{sc}< 10\mu\text{s}$ $T_C\leq 25^\circ\text{C}$		116.7		A
Dynamic Characteristics						
Input capacitance	C_{ies}	$V_{CE}=25\text{V}$, $V_{GE}=0\text{V}$, $f=1.0\text{MHZ}$, $T_C=25^\circ\text{C}$	-	1500	-	pF
Output capacitance	C_{oes}		-	128	-	pF
Reverse transfer capacitance	C_{res}		-	28.7	-	pF
Switching Characteristics						
Turn-On delay time	$t_d(on)$	$V_{CE}=400\text{V}$, $I_C=20\text{A}$, $R_G=10\Omega$, $V_{GE}=15\text{V}$ $T_C=25^\circ\text{C}$ Inductive Load	-	16	-	ns
Turn-On rise time	t_r		-	56	-	ns
Turn-off delay time	$t_d(off)$		-	52	-	ns
Turn-off Fall time	t_f		-	82	-	ns
Turn-on energy	E_{on}		-	0.79	-	mJ
Turn-off energy	E_{off}		-	0.3	-	mJ
Total switching Energy	E_{total}		-	1.09	-	mJ
Turn-On delay time	$t_d(on)$		$V_{CE}=400\text{V}$, $I_C=20\text{A}$, $R_G=10\Omega$, $V_{GE}=15\text{V}$ $T_C=175^\circ\text{C}$ Inductive Load	-	14	-
Turn-On rise time	t_r	-		54	-	ns
Turn-off delay time	$t_d(off)$	-		76	-	ns
Turn-off Fall time	t_f	-		146	-	ns
Turn-on energy	E_{on}	-		0.8	-	mJ
Turn-off energy	E_{off}	-		0.49	-	mJ
Total switching Energy	E_{total}	-		1.3	-	mJ

Total Gate Charge	Qg	V _{CE} =400V, I _c =20A R _G =10Ω, V _{GE} =15V T _C =25°C (note3,4)	-	43.9	-	nC
Gate to emitter charge	Qge		-	10.0	-	
Gate to collector charge	Qgc		-	18.9	-	
Gate resistance	Rg	f=1MHz, open collector	-	1.8	-	Ω
Anti-Paraller Diode Characteristics and Maximum Ratings						
Diode Forward Voltage	V _F	V _{GE} =0V, I _F =20A. T _C =25°C	-	1.4	-	V
		T _C =125°C	-	1.2	-	V
		T _C =175°C	-	1.0	-	V
Diode Reverse recovery time	t _{rr}	V _{GE} =0V, I _F =20A di=/dt=100A/us (note 4) T _C =25°C	-	254	-	ns
Reverse recovery charge	Q _{rr}		-	347	-	nC
Diode Reverse recovery Current	I _{rrm}		-	2.7	-	A
Diode Reverse recovery time	t _{rr}	V _{GE} =0V, I _F =20A di=/dt=100A/us (note 4) T _C =175°C	-	429	-	ns
Reverse recovery charge	Q _{rr}		-	1010	-	nC
Diode Reverse recovery Current	I _{rrm}		-	4	-	A

Thermal Characteristics

Parameter	Symbol	MSG20T6 5FQS	MSG20T65FQT/ MSG20T65FQE	MSG20T6 5FQC	Unit
IGBT Thermal Resistance, Junction to Case	R _{th(j-c)}	3.57	0.77	0.77	°C/W
FRD Thermal Resistance, Junction to Case	R _{th(j-c)}	7.7	2.05	2.05	°C/W
Thermal Resistance, Junction to Ambient	R _{th(j-A)}	62.5	62.5	33.8	°C/W

Order Message

Order codes	Package	Packaging
MSG20T65FQS	TO-220F	Tube
MSG20T65FQT	TO-220	Tube
MSG20T65FQE	TO-263	Tube
MSG20T65FQC	TO-247	Tube

Electrical Characteristics (curves)

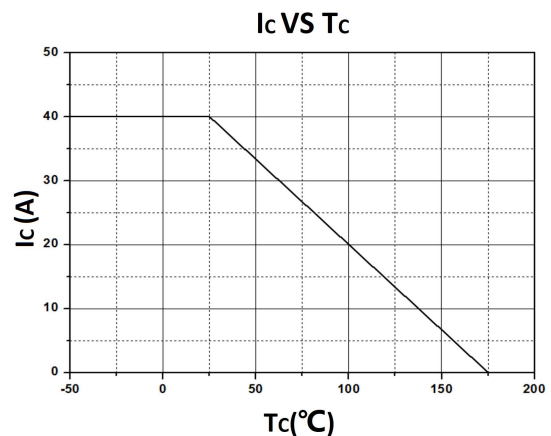
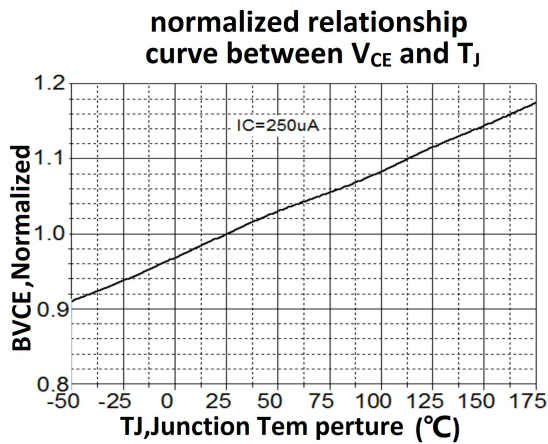
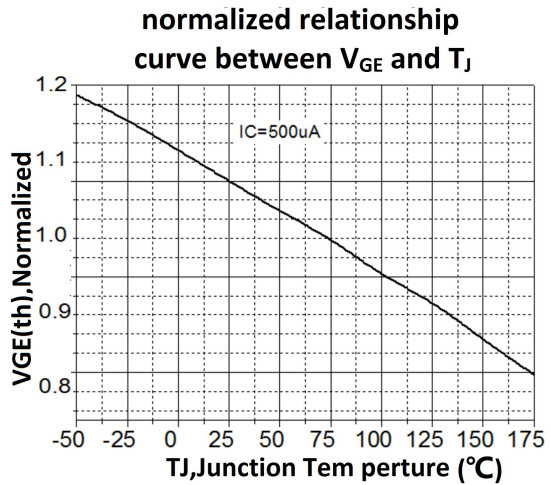
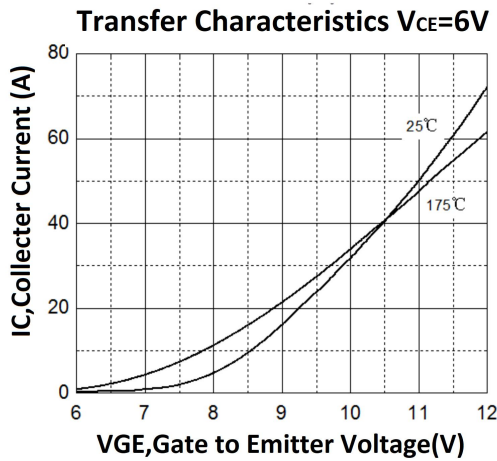
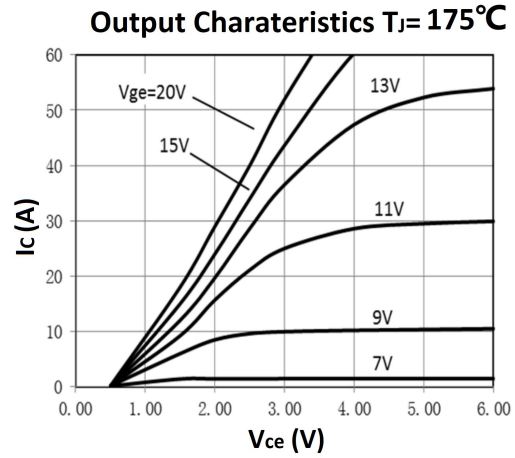
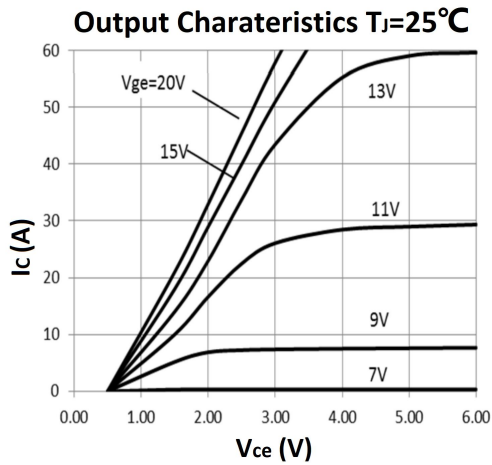

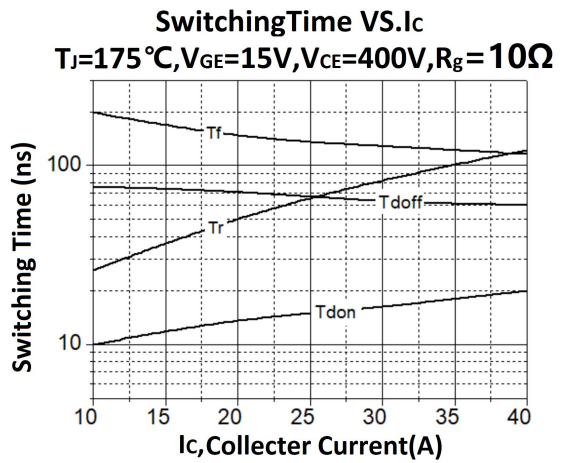
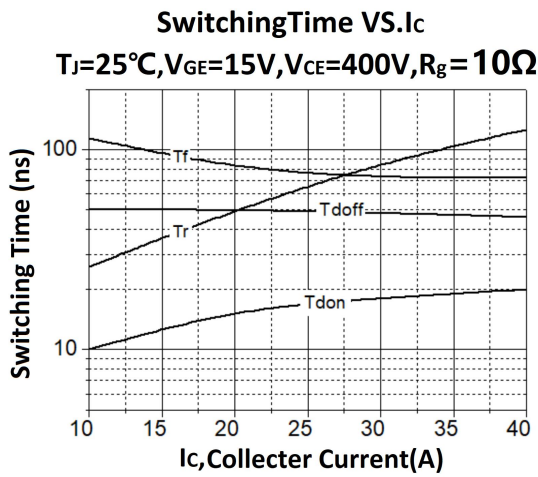
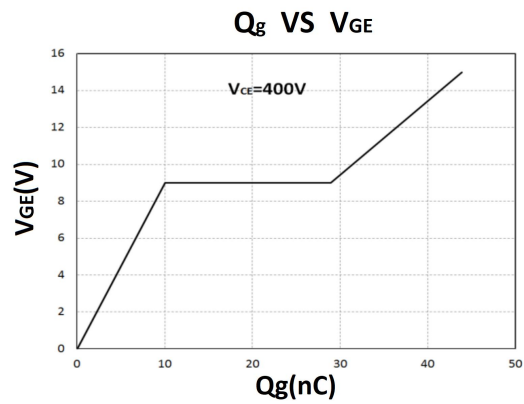
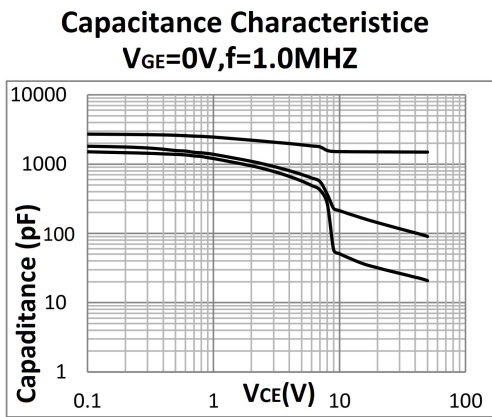
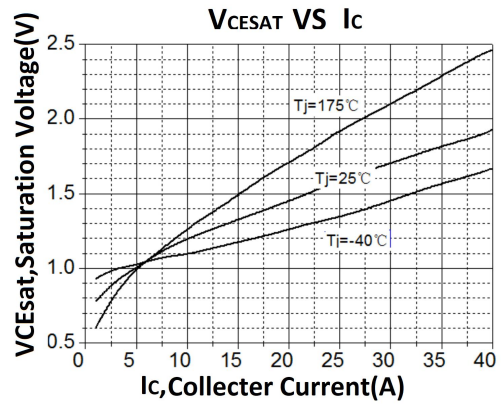
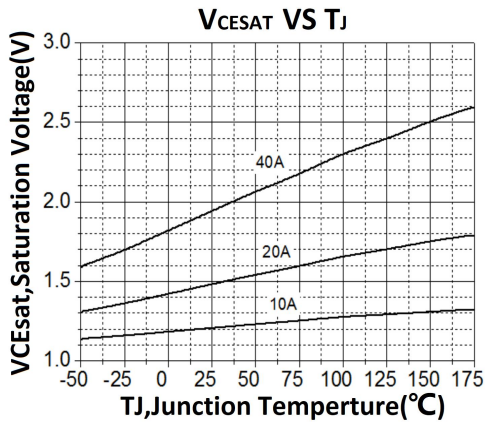

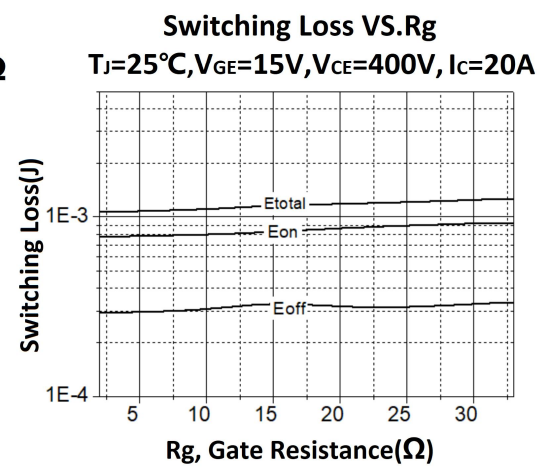
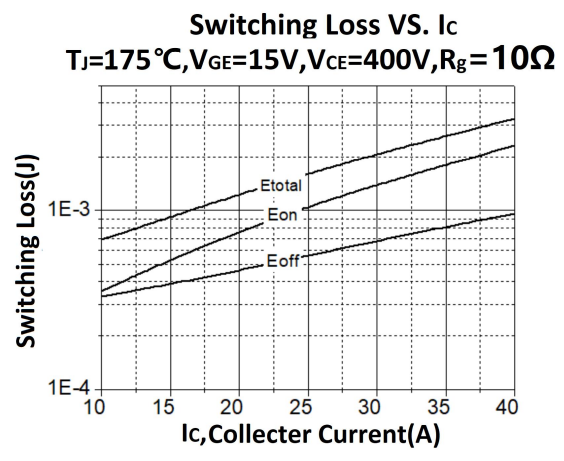
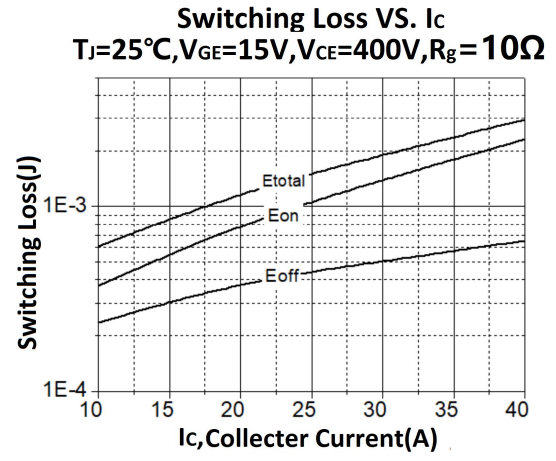
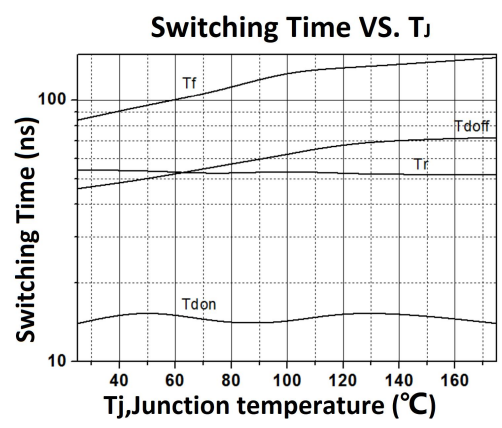
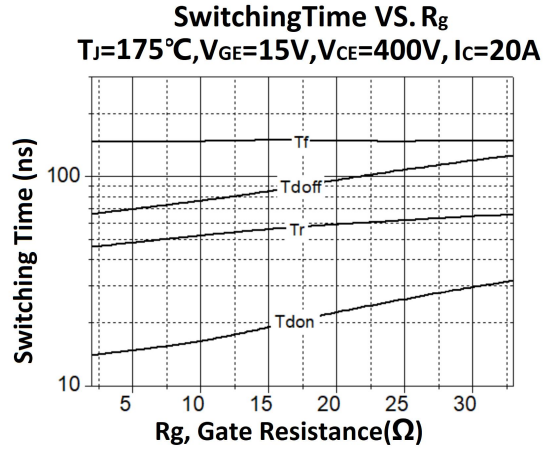
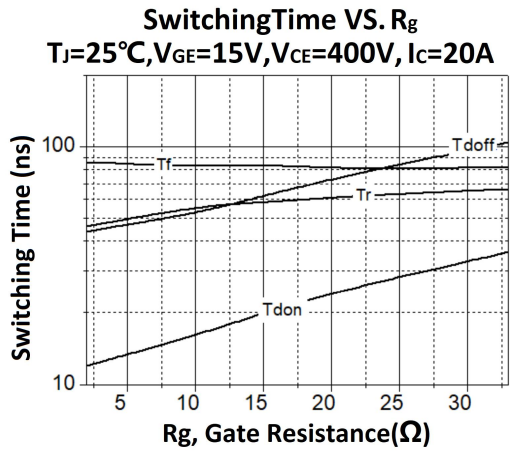

Switching Loss VS. Rg
 $T_J=175^\circ\text{C}, V_{GE}=15\text{V}, V_{CE}=400\text{V}, I_C=20\text{A}$

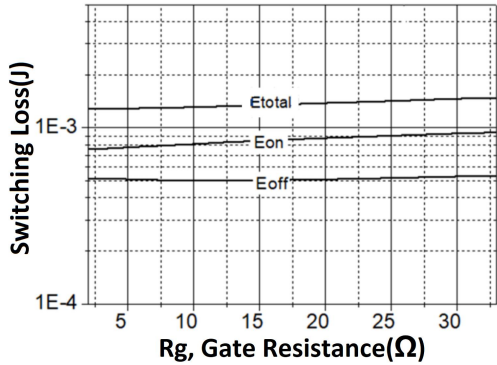

Switching Loss VS. Tj
 $V_{GE}=15\text{V}, V_{CE}=400\text{V}, I_C=20\text{A}, R_g=10\Omega$

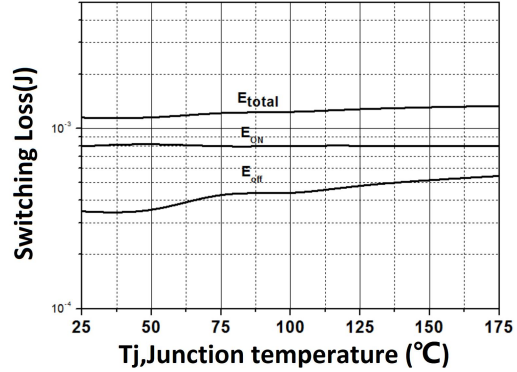

Switching Loss VS. Vce(V)
 $T_J=175^\circ\text{C}, V_{GE}=15\text{V}, I_C=20\text{A}, R_g=10\Omega$

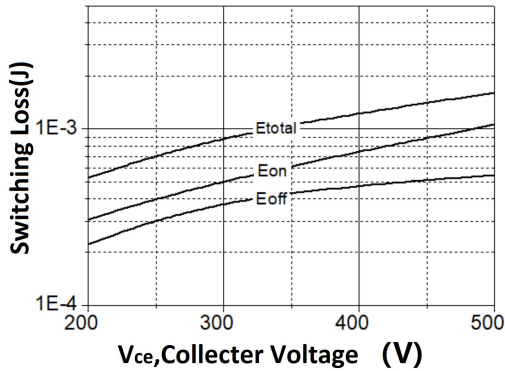

Safe Operating Area TO-247

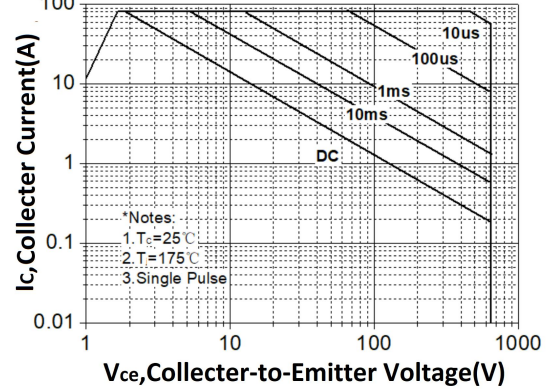

Safe Operating Area TO-220 /TO-263

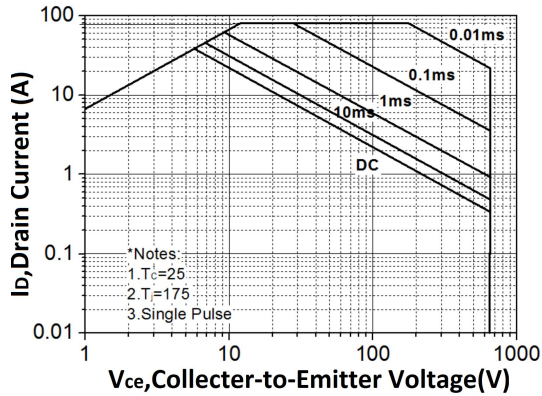

Safe Operating Area TO-220F

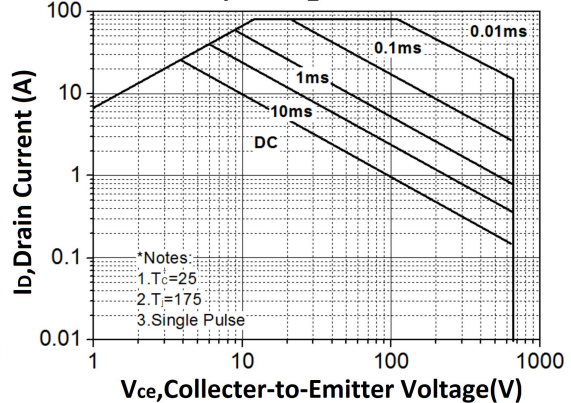

P_D VS temperature (TO-220/TO-263)

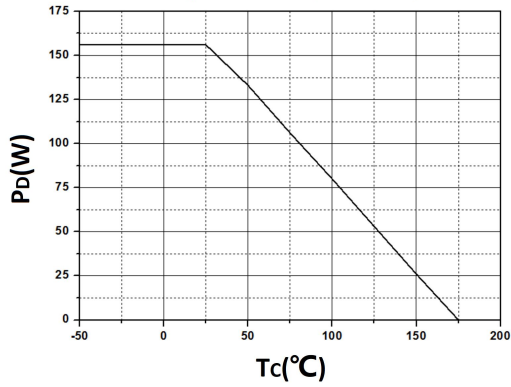

P_D VS temperature (TO-247)

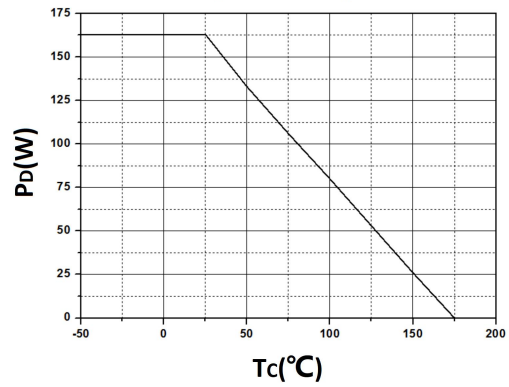

P_D VS temperature (TO-220F)

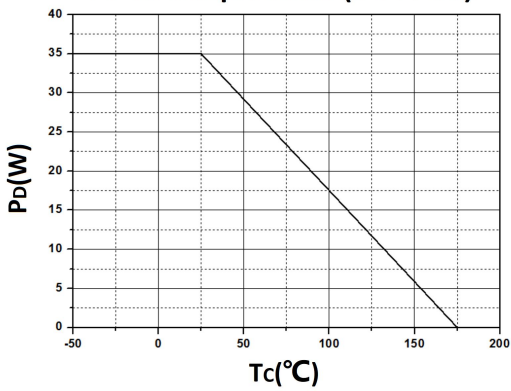

Diode Characteristic

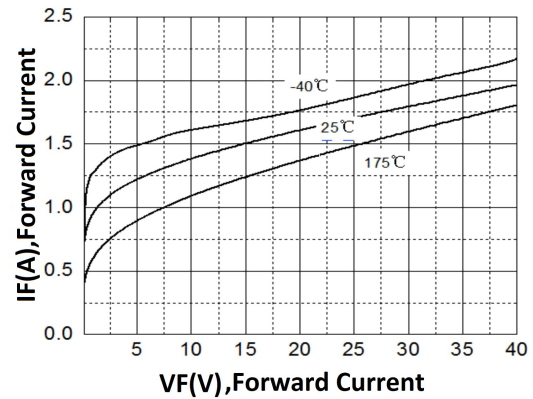

T_{rr} and di/dt

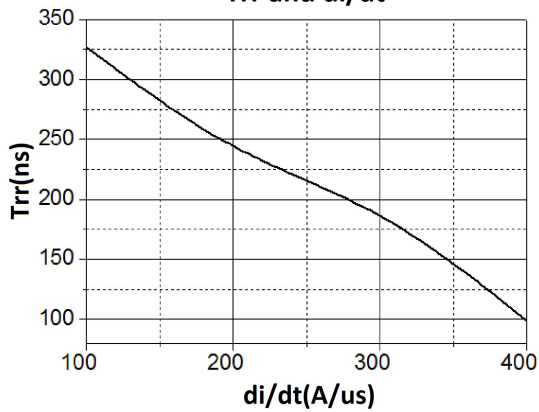

Q_{rr} and di/dt

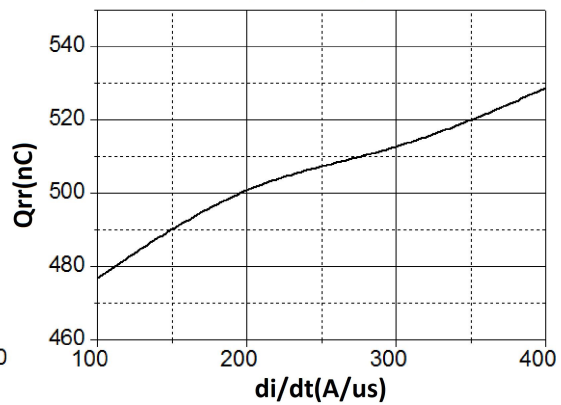

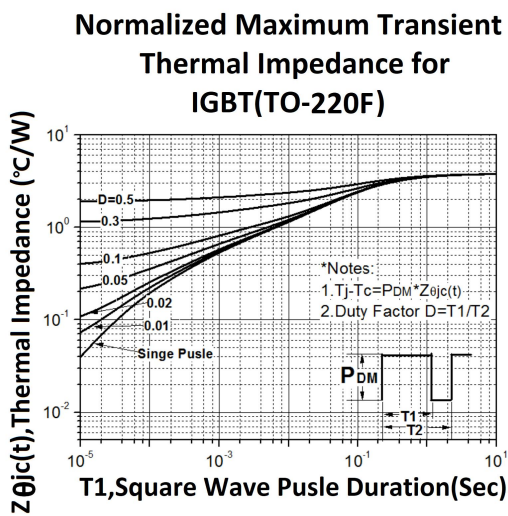
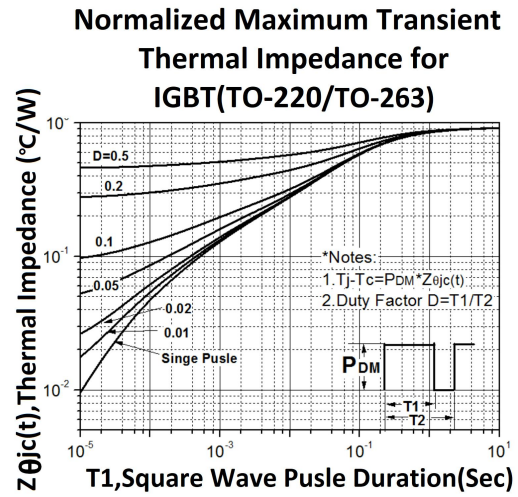
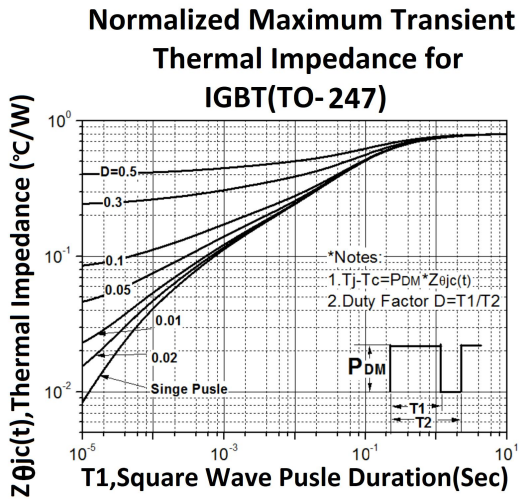
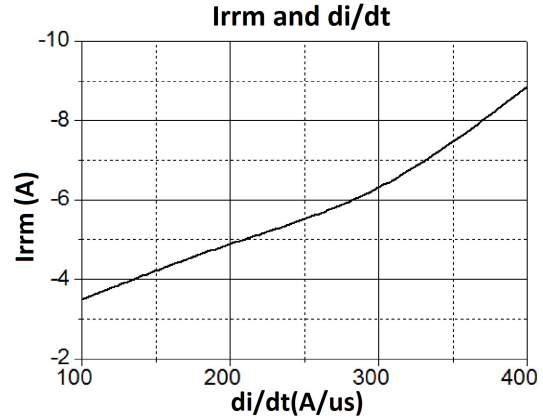
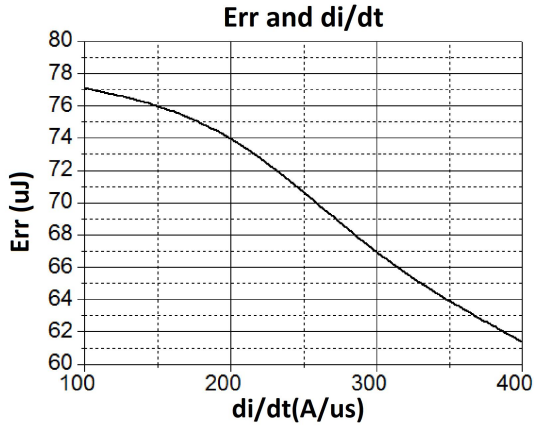

Package Mechanical DATA

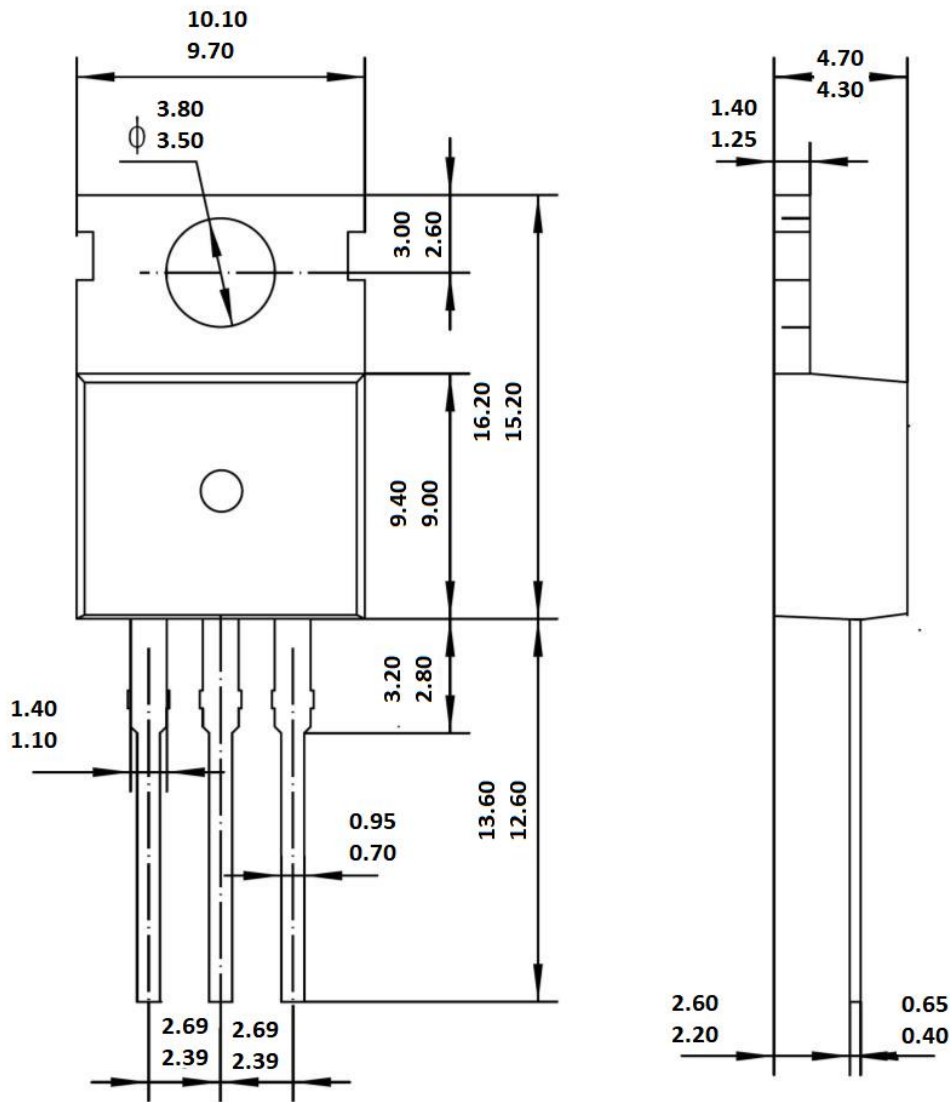

TO-220

Unit: mm

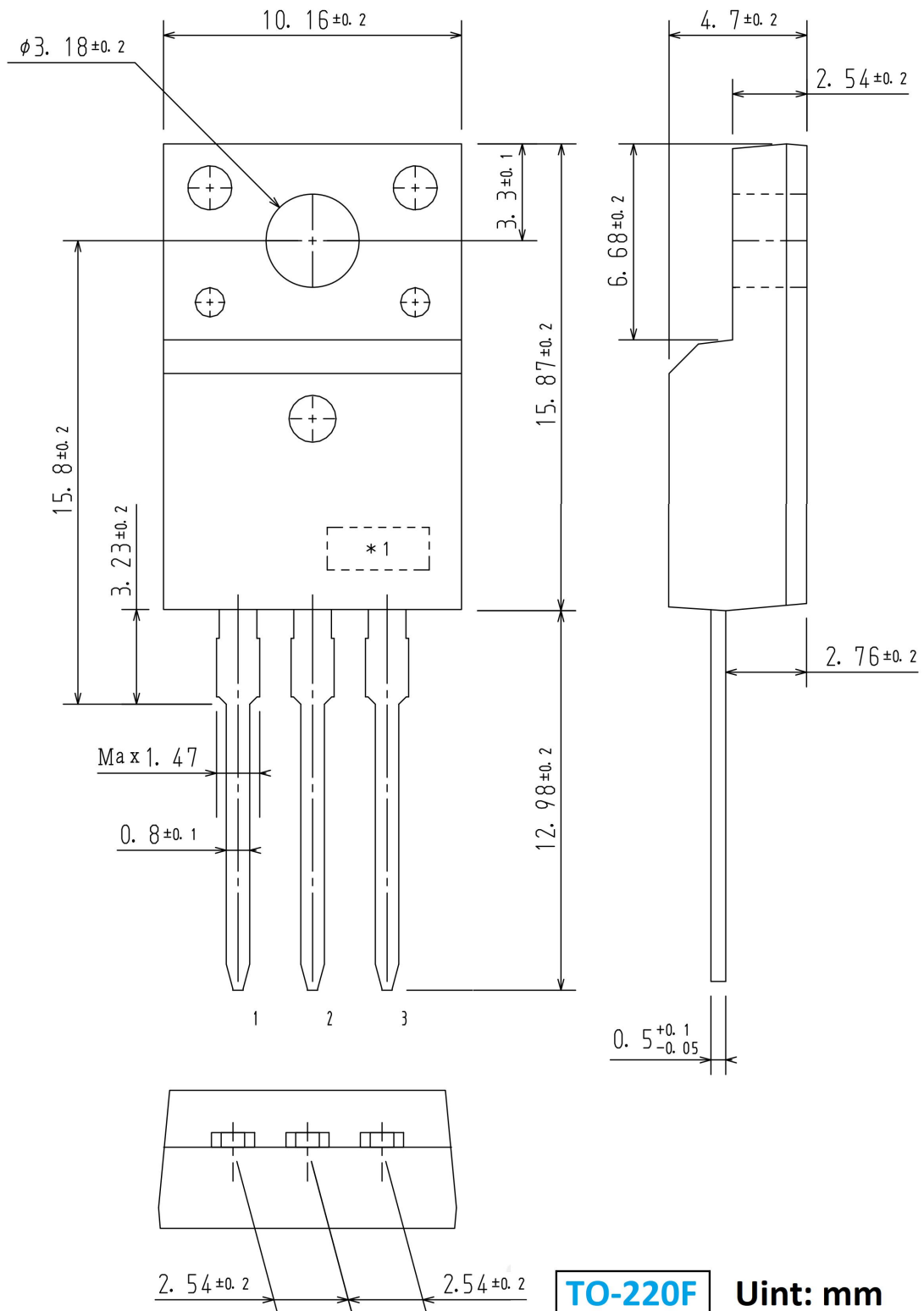

TO-220F

Unit: mm

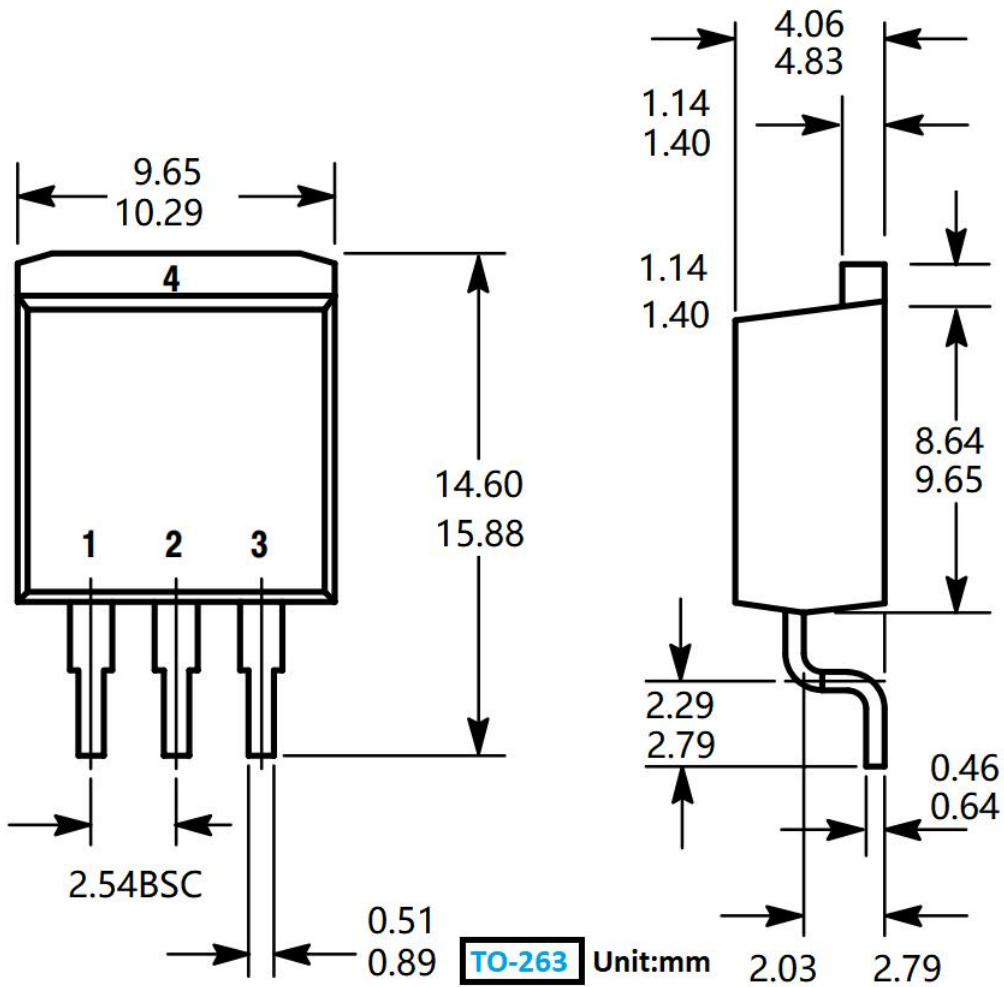
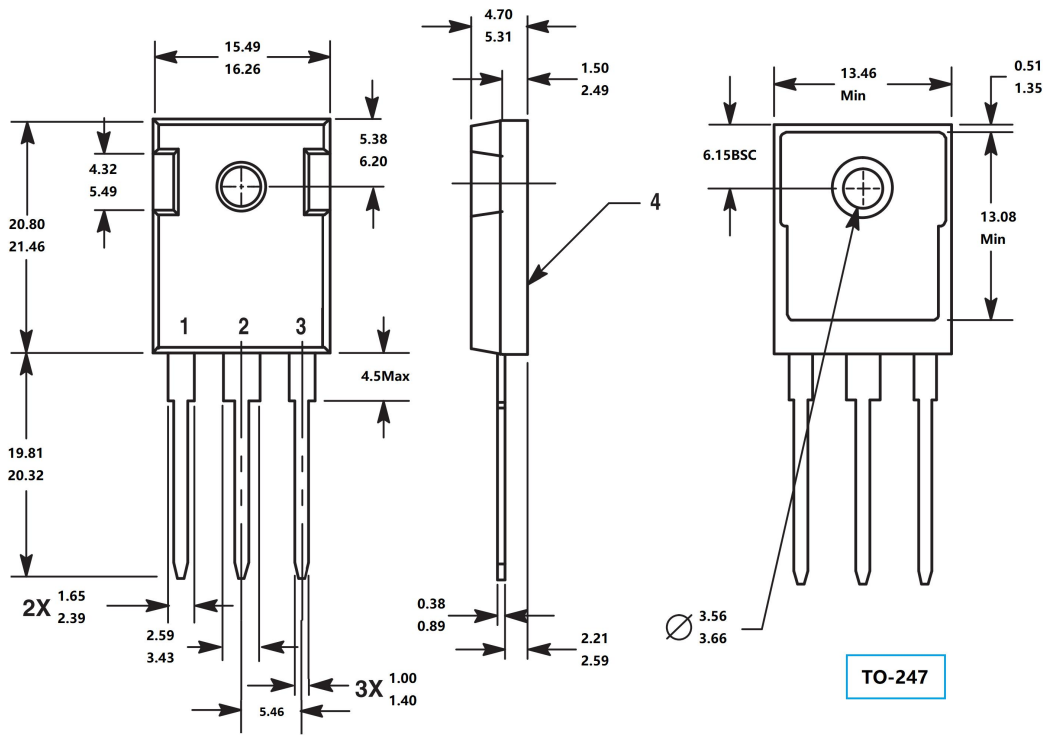

X-ON Electronics

Largest Supplier of Electrical and Electronic Components

Click to view similar products for [MASPOWER](#) manufacturer:

Other Similar products are found below :

[EST100BN120SN](#) [EST100BN60SN](#) [EST60BN120SN](#) [ESTF100SS60S](#) [ESTF15SS120C](#) [ESTF15SS135UC](#) [ESTF15SS60SC](#) [ESTF25D20SB](#)
[ESTF30S120U](#) [ESTF30SS60SC](#) [ESTF45D60U](#) [ESTF60SS120US](#) [ESTF60SS60US](#) [ESTF75D60U](#) [ESTF80D22U](#) [ESTF8SS120C](#)
[ESTF8SS195UP](#) [MS100N20HGC0](#) [MS100N20IDC0](#) [MS10N100HGC0](#) [MS10N100HGT1](#) [MS10N120HGC0](#) [MS10N40HGT0](#) [MS10N60FT](#)
[MS120N10FT](#) [MS120N15FB](#) [MS120N15FE](#) [MS12N100FC](#) [MS12N100FS](#) [MS12N100FT](#) [MS12N120HGC0](#) [MS12N120HJC0](#)
[MS13N20HGD0](#) [MS140N30HGB3](#) [MS140N30HGC0](#) [MS15N100HGC0](#) [MS15N100HGT1](#) [MS15N120HGC0](#) [MS170N15IDC0](#)
[MS170N25HGF4](#) [MS170N65HGF4](#) [MS18N100HGC0](#) [MS18N20FT](#) [MS20N50FS](#) [MS30N100HGC0](#) [MS33N10FT](#) [MS33N20HGC0](#)
[MS38N65FCC](#) [MS3N06FF](#) [MS3N100HGD0](#)