

## Features

- Low gate charge
- Trench FS Technology,
- saturation voltage:  $V_{CE(sat)}$ ,  
typ = 1.6V,  $I_C=20A$  and  $T_C=25^\circ C$
- RoHS product

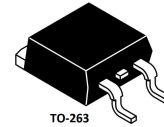
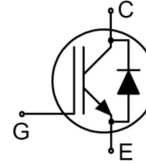
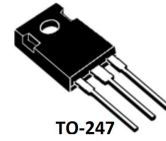

## Applications

- General purpose inverters
- UPS

## Absolute Ratings ( $T_C=25^\circ C$ )

Parameter	Symbol	Typ	Unit
Collector-Emmitter Voltage	$V_{ces}$	650	V
Collector Current-continuous	$I_C$ $T=25^\circ C$ $T=100^\circ C$	40	A
		20	A
Collector Current-pulse	$I_{CM}$	80	A
Diode RMS forward current	$I_F$ $T=25^\circ C$ $T=100^\circ C$	40	A
		20	A
Gate-Emmitter Voltage	$V_{GES}$	$\pm 20$	V
Turn-off safe area	-	180	A
Surge non repetitive forward current $t_p=10ms$ sinusoidal	$I_{FSM}$	80	A
Power Dissipation (TO-247/TO-263)	$P_D$ $T_C=25^\circ C$	162	W
		46	W
Diode Forward Current	$T_C=100^\circ C$	20	A
Operating and Storage Temperature Range	$T_J, T_{STG}$	-55~+150	$^\circ C$
Maximum Lead Temperature for Soldering Purposes	$T_L$	300	$^\circ C$

\*Collector current limited by maximum Junction temperature

## Thermal Characteristic

Parameter	Symbol	Tests conditions	Min	Typ	Max	Units
Off-Characteristics						
Collector-Emmitter Voltage	$BV_{CES}$	$I_C=500\mu A, V_{GE}=0V$	650	-	-	V

Breakdown Voltage Temperature Coefficient	$\Delta BV_{CES}/\Delta T_J$	$I_C=1\text{mA}$ , reference to 25°C	-	0.5	-	V/°C
Zero Gate Voltage Collector Current	$I_{CES}$	$V_{CE}=650\text{V}$ , $V_{GE}=0\text{V}$ , $T_C=25^\circ\text{C}$	-		10	$\mu\text{A}$
Gate-body leakage current	$I_{GESF}$	$V_{CE}=0\text{V}$ , $V_{GE}=\pm 20\text{V}$	-	-	200	nA
<b>On-Characteristics</b>						
Gate-Emmitter Threshold Voltage	$V_{GE(th)}$	$V_{CE}=V_{GE}$ , $I_C=250\mu\text{A}$	4.5	-	6.5	V
Collector-Emmitter saturation Voltage	$V_{CESAT}$	$V_{GE}=15\text{V}$ , $I_C=20\text{A}$ , $T_C=25^\circ\text{C}$	-	1.6	2.0	V
		$T_C=125^\circ\text{C}$		1.75	2.15	
		$T_C=175^\circ\text{C}$		1.9	2.3	
Short Collector current	$I_C(sc)$	$V_{GE}=15\text{V}$ $V_{CE}=360\text{V}$ $t_{sc}< 10\mu\text{s}$ $T_C=25^\circ\text{C}$		116.7		A
<b>Dynamic Characteristics</b>						
Input capacitance	$C_{ies}$	$V_{CE}=25\text{V}$ , $V_{GE}=0\text{V}$ , $f=1.0\text{MHz}$ , $T_C=25^\circ\text{C}$	-	1500	-	pF
Output capacitance	$C_{oes}$		-	128	-	pF
Reverse transfer capacitance	$C_{res}$		-	28.7	-	pF
<b>Switching Characteristics</b>						
Turn-On delay time	$t_d(on)$	$V_{CE}=400\text{V}$ , $I_C=20\text{A}$ , $R_G=10\Omega$ , $V_{GE}=15\text{V}$ $T_C=25^\circ\text{C}$ Inductive Load	-	16	-	ns
Turn-On rise time	$t_r$		-	56	-	ns
Turn-off delay time	$t_d(off)$		-	52	-	ns
Turn-off Fall time	$t_f$		-	82	-	ns
Turn-on energy	$E_{on}$		-	0.79	-	mJ
Turn-off energy	$E_{off}$		-	0.3	-	mJ
Total switching Energy	$E_{total}$		-	1.09	-	mJ
Total Gate Charge	$Q_g$	$V_{CE}=400\text{V}$ , $I_C=20\text{A}$ , $R_G=10\Omega$ , $V_{GE}=15\text{V}$	-	43.9	-	nC
<b>Anti-Paraller Diode Characteristics and Maximum Ratings</b>						
Diode Forward Voltage	$V_F$	$V_{GE}=0\text{V}$ , $I_F=20\text{A}$ , $T_C=25^\circ\text{C}$	-	1.4	-	V
		$V_{GE}=0\text{V}$ , $I_F=20\text{A}$ , $T_C=175^\circ\text{C}$	-	1.0	-	V
Diode Reverse recovery time	$t_{rr}$	$V_{GE}=0\text{V}$ , $I_F=20\text{A}$ $di/dt=100\text{A}/\mu\text{s}$	-	254	-	ns
Reverse recovery	$Q_{rr}$		-	347	-	$\mu\text{C}$

charge						
Diode Reverse recovery Current	I <sub>rrm</sub>	-	2.7	-	A	

Parameter	Symbol	Type		Unit
		TO-263/TO-247	TO-220F	
IGBT Thermal Resistance, Junction to Case	R <sub>th(j-c)</sub>	0.77	2.71	°C/W
FRD Thermal Resistance, Junction to Case	R <sub>th(j-c)</sub>	2.05	7.7	°C/W
Thermal Resistance, Junction to Ambient	R <sub>th(j-A)</sub>	33.8	62.5	°C/W

**Order information**

type	Package
<b>MSG20T65HPC0</b>	<b>TO-247</b>
<b>MSG20T65HPE0</b>	<b>TO-263</b>
<b>MSG20T65HPT1</b>	<b>TO-220F</b>

### Electrical Characteristics (curves)

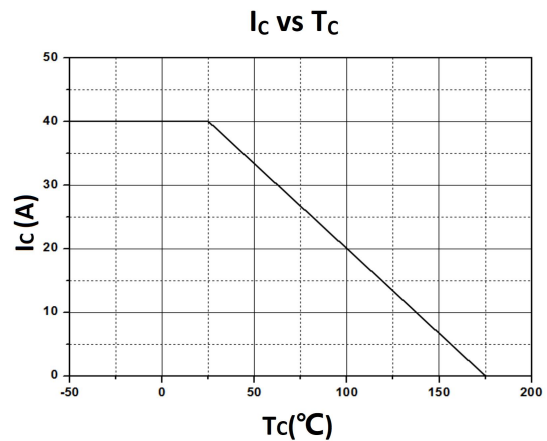
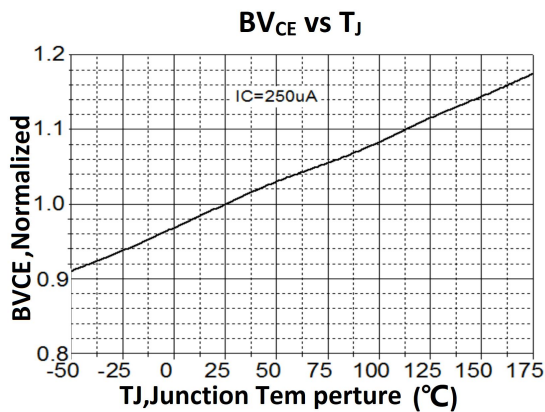
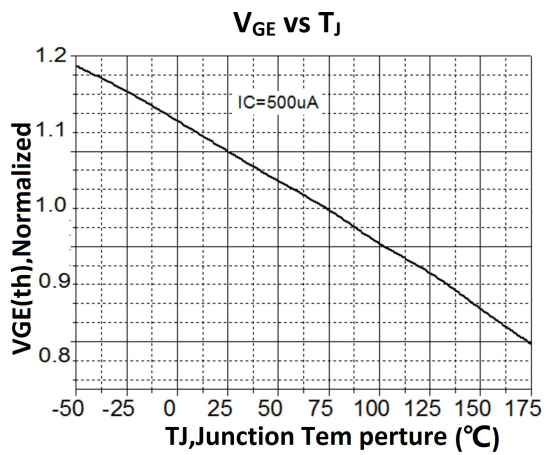
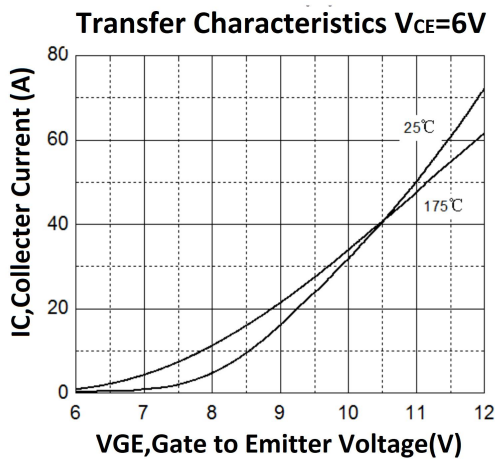
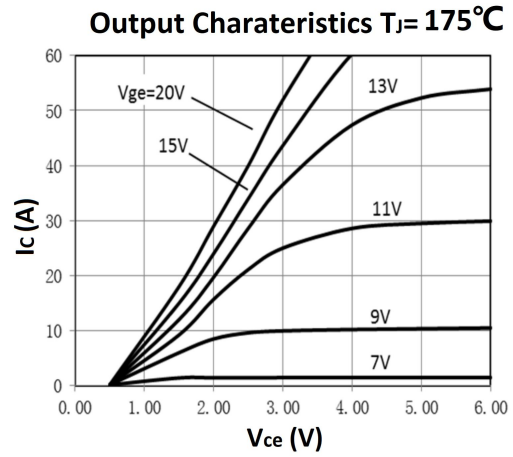
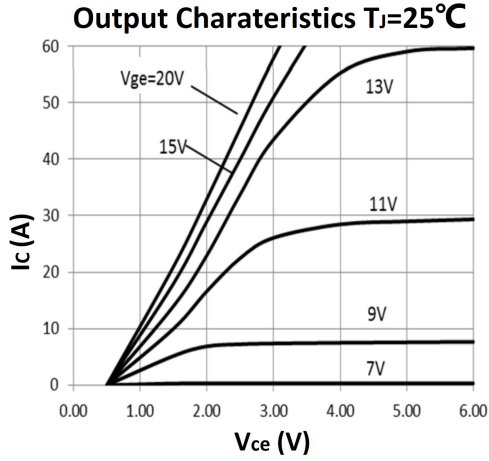

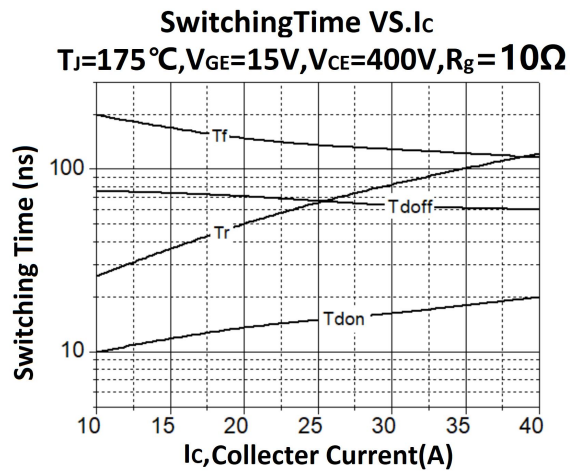
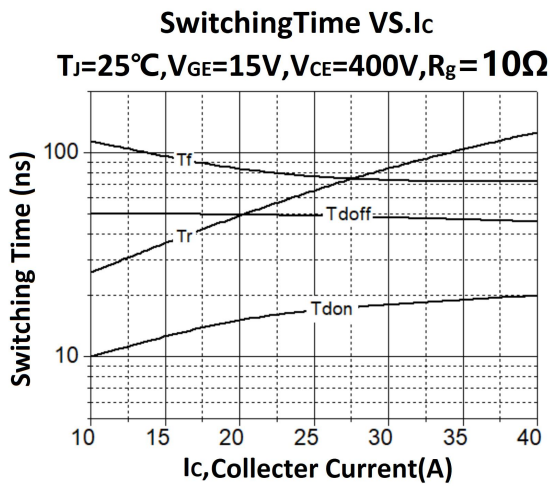
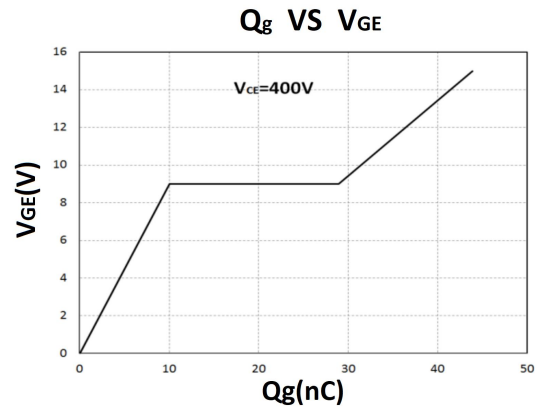
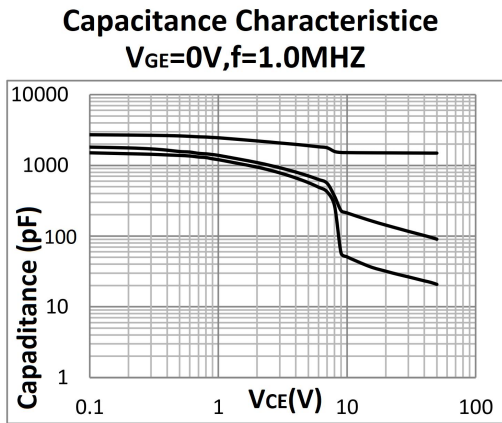
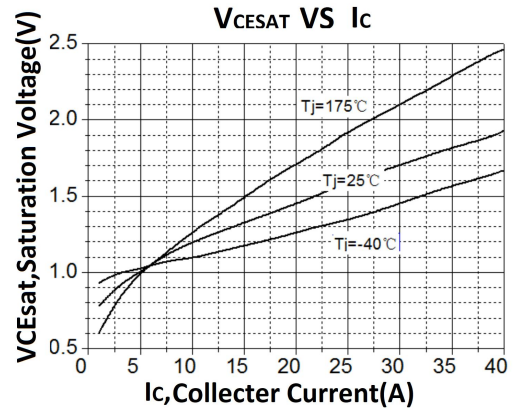
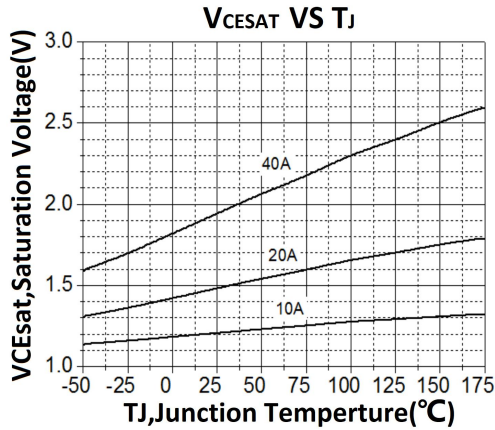

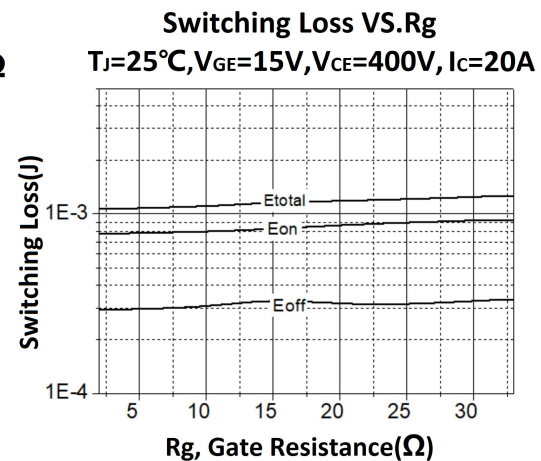
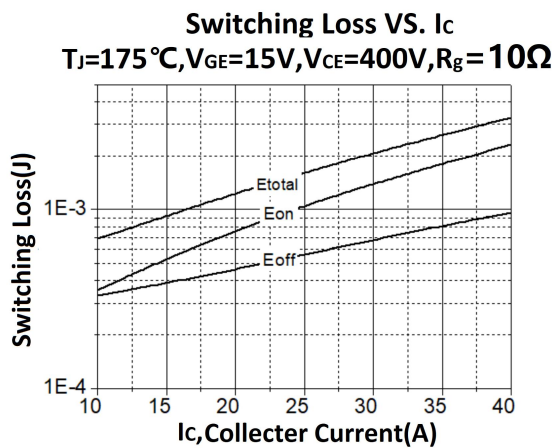
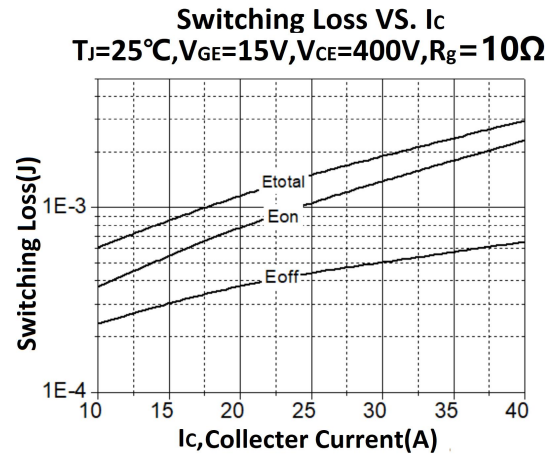
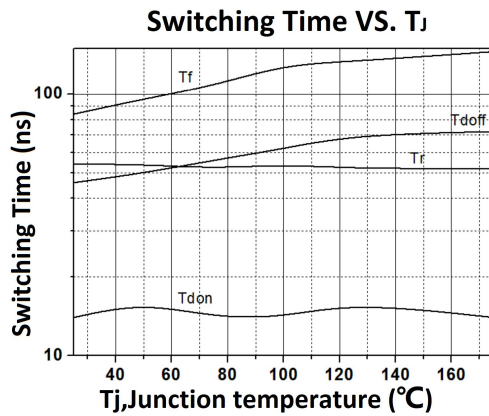
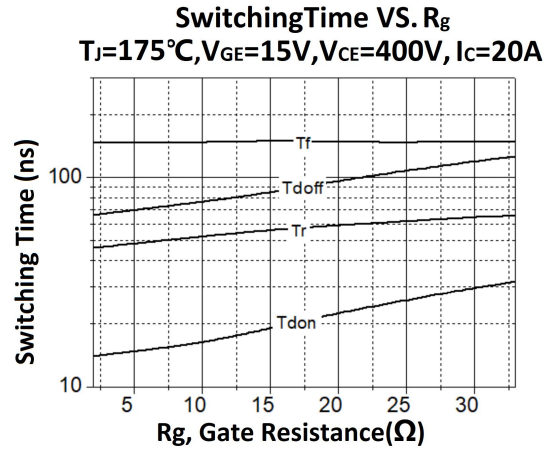
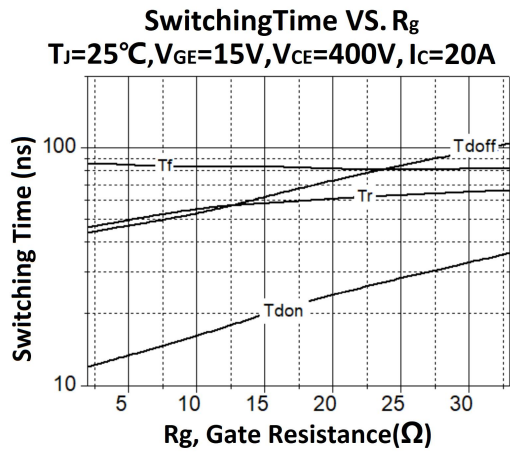



**Switching Loss VS. Rg**  
 $T_J=175^{\circ}\text{C}, V_{GE}=15\text{V}, V_{CE}=400\text{V}, I_C=20\text{A}$

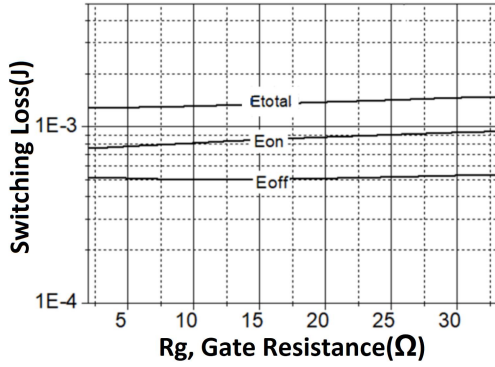

**Switching Loss VS. Tj**  
 $V_{GE}=15\text{V}, V_{CE}=400\text{V}, I_C=20\text{A}, R_G=10\Omega$

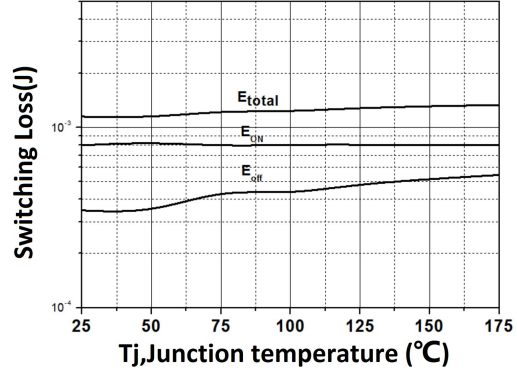

**Switching Loss VS. Vce(V)**  
 $T_J=175^{\circ}\text{C}, V_{GE}=15\text{V}, I_C=20\text{A}, R_G=10\Omega$

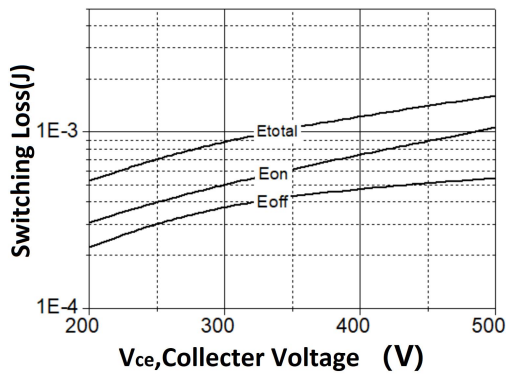

**Safe Operating Area TO-247**

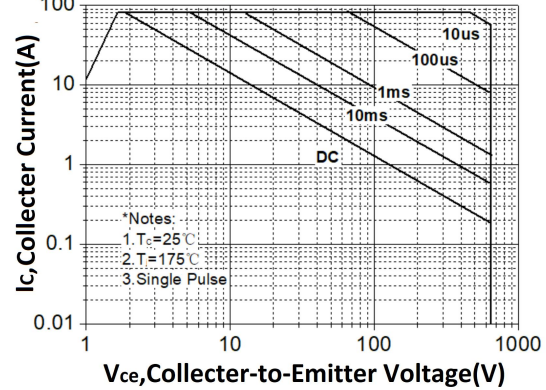

**Pd VS temperature (TO-247)**

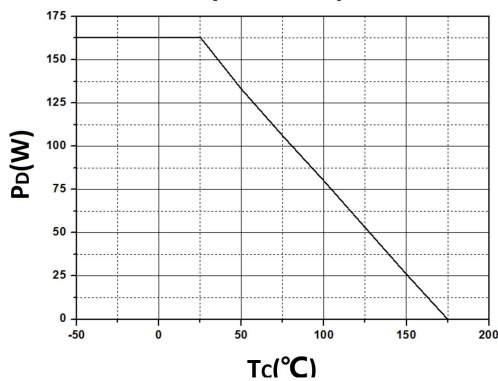

**Diode Characteristic**

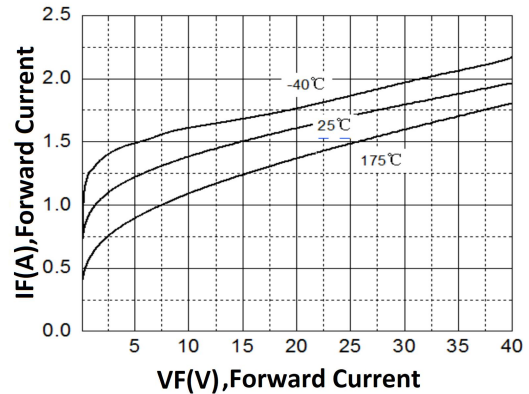

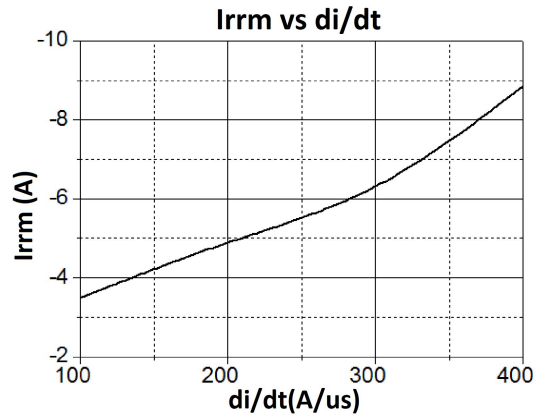
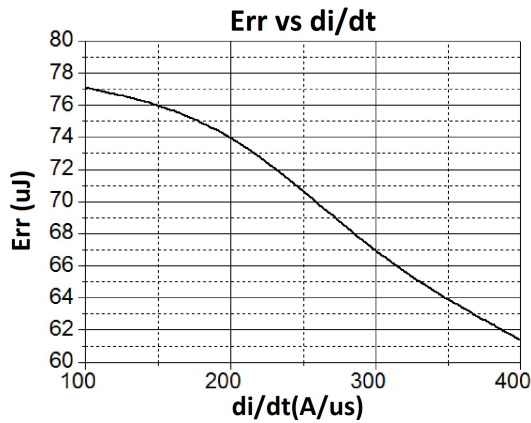
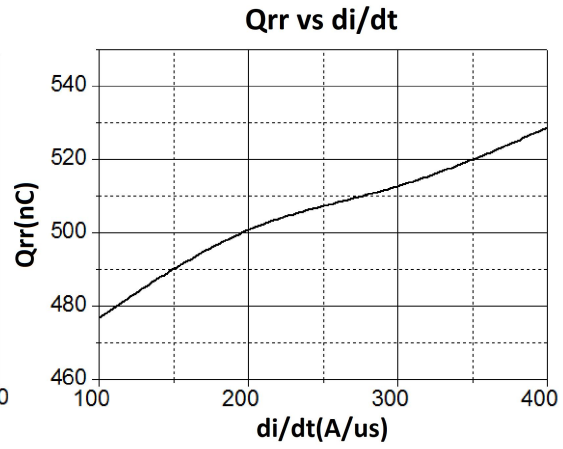
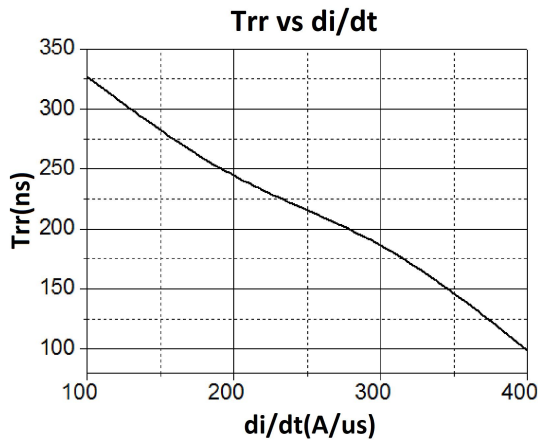

### Normalized Maximum Transient Thermal Impedance for IGBT(TO-247)

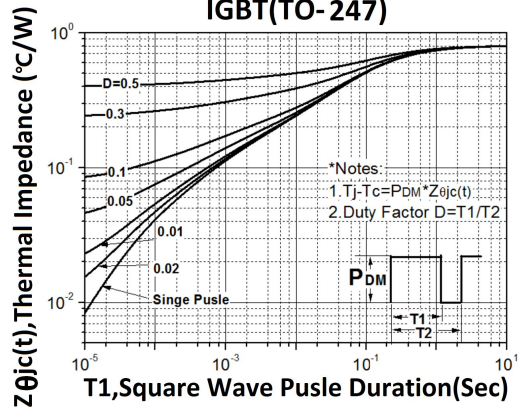



### Package Mechanical DATA

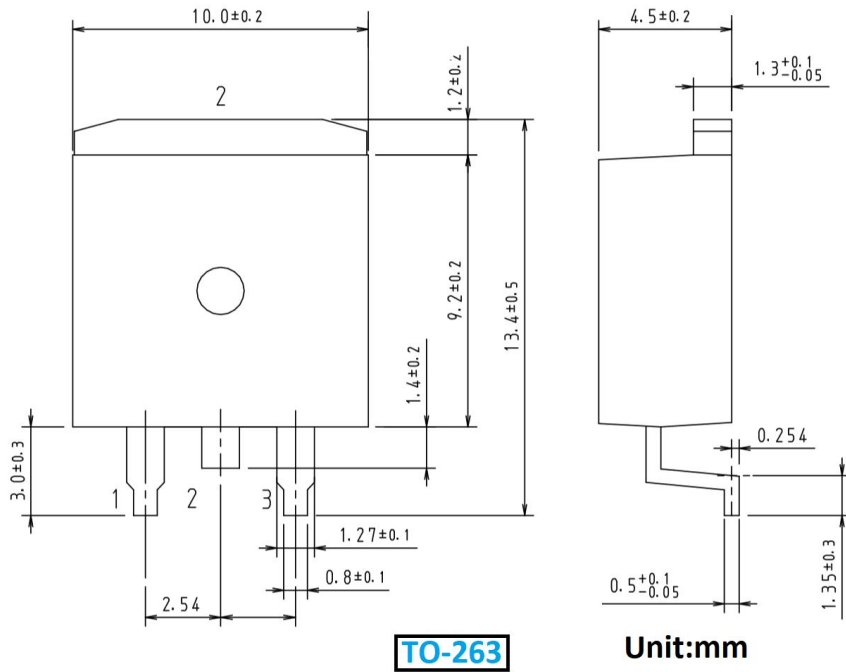
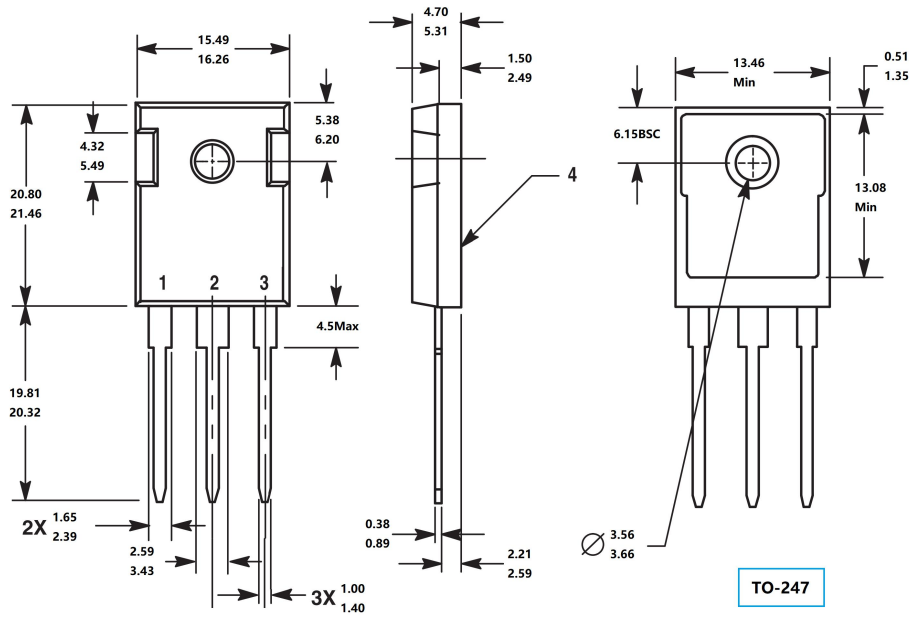



## X-ON Electronics

Largest Supplier of Electrical and Electronic Components

*Click to view similar products for [MASPOWER](#) manufacturer:*

Other Similar products are found below :

[MSG80N60FQC](#) [MS8N120FE](#) [PWM815YBN](#) [MS8N120FC](#) [MS6N120FE](#) [MS60N60HGC1](#) [ESTF60SS120US](#) [MSG40T120FQC](#)  
[MSG50T120FQW](#) [MS5N100FT](#) [ESTF15SS135UC](#) [MS170N25HGF4](#) [MS5N170FC](#) [EST100BN120SN](#) [EST60BN120SN](#) [MS50N100HGF4](#)  
[MS170N65HGF4](#) [MSG50N350FH](#) [MS8N100FS](#) [ESTF8SS120C](#) [MS30N100HGC0](#) [MSG120T65HLC1](#) [ESTF80D22U](#) [MS3N100HGT1](#)  
[EST100BN60SN](#) [MSG60T65HHC0](#) [MSG20T65FQC](#) [MS12N100FS](#) [MSG40T65HHC0](#) [MS120N10FT](#) [MS50N20FC](#) [MS38N65FCC](#)  
[MSG40T65HPC0](#) [MSG100T65HLB3](#) [MSG50T65FQC](#) [MS12N100FC](#) [MS12N120HJC0](#) [MS10N120HGC0](#) [MS6N100FE](#) [MS15N120HGC0](#)  
[MS100N20IDC0](#) [MS15N100HGC0](#) [MS3N100HGD1](#) [MS140N30HGB3](#) [ESTF15SS120C](#) [MS120N15FB](#) [MS10N100HGC0](#) [MS8N100FE](#)  
[MSG25T120FQC](#) [MS4N1350W](#)