

## Features

- Low gate charge
- Trench FS Technology
- Saturation voltage:  $V_{CE(sat), typ} = 1.6V$   
@ $I_C = 50A$  and  $T_C = 25^\circ C$

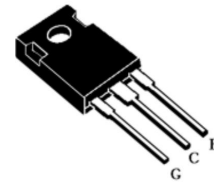

## Applications

- General purpose inverter
- UPS

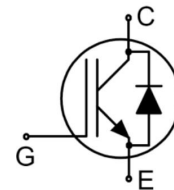

## Absolute Ratings ( $T_C = 25^\circ C$ )

Parameter	Symbol	Value	Unit
		MSG50T65FQC	
Collector-Emmitter Voltage	$V_{ce}$	650	V
*Collector Current-continuous	$I_C$ $T = 25^\circ C$ $T = 100^\circ C$	100	A
		50	A
Diode forward current	$I_F$ $T_C = 25^\circ C$ $T_C = 100^\circ C$	100	A
		50	A
Collector Current-pulse (note 1)	$I_{CM}$	200	A
Gate-EMMiter Voltage	$V_{GES}$	$\pm 20$	V
Turn-off safe area	-	200	A
Power Dissipation	PD $T_C = 25^\circ C$	437	W
Operating and Storage Temperature Range	$T_J, T_{STG}$	-55~+150	$^\circ C$
Maximum Lead Temperature for Soldering Purposes	$T_L$	300	$^\circ C$

\*Collector current limited by maximum junction temperature

**Electrical Characteristics**

Parameter	Symbol	Tests conditions	Min	Typ	Max	Units
<b>Off-Characteristics</b>						
Collector-Emmitter Voltage	$BV_{CES}$	$I_c=250\mu A, V_{GE}=0V$	650	-	-	V
Breakdown Voltage Temperature Coefficient	$\Delta BV_{CES}/\Delta T_J$	$I_c=0.5mA$ , referenced to 25°C	-	0.6	-	V/°C
Zero Gate Voltage Collector Current	$I_{CES}$	$V_{CE}=650V, V_{GE}=0V, T_c=25^\circ C$	-	-	0.2	mA
Gate-body leakage current, forward	$I_{GESF}$	$V_{CE}=0V, V_{GE}=20V$	-	-	200	nA
Gate-body leakage current, reverse	$I_{GESR}$	$V_{CE}=0V, V_{GE}=-20V$	-	-	-200	nA
<b>On-Characteristics</b>						
Gate Threshold Voltage	$V_{GE(th)}$	$V_{CE}=V_{GE}, I_c=250\mu A$	4.5	-	6.5	V
Collector-Emmitter saturation Voltage	$V_{CESAT}$	$V_{CE}=15V, I_c=50A, T_c=25^\circ C$	-	1.6	2.2	V
Short Collector current(Note 2)	$I_{c(SC)}$	$V_{GE}=15V, V_{CE}=300V, t_{sc}<10\mu s, T_c=25^\circ C$	-	295	-	A
<b>Dynamic Characteristics</b>						
Input capacitance	$C_{ies}$	$V_{CE}=25V, V_{GE}=0V, f=1.0MHz$	-	3435	-	pF
Output capacitance	$C_{oes}$		-	283	-	pF
Reverse transfer capacitance	$C_{res}$		-	79.8	-	pF

**Electrical Characteristics**

Parameter	Symbol	Tests conditions	Min	Typ	Max	Units
<b>Switching Characteristics</b>						
Turn-on delay time	td(on)	V <sub>CE</sub> =400V, I <sub>c</sub> =50A, R <sub>G</sub> =10Ω, V <sub>GE</sub> =15V, Parasitic ductance=75nH T <sub>c</sub> =25°C	-	35	-	ns
Turn-On rise time	tr		-	100	-	ns
Turn-Off delay time	td(off)		-	134	-	ns
Turn-Off Fall time	t <sub>f</sub>		-	75	-	ns
Turn-on energy	E <sub>on</sub>		-	1.55	-	mJ
Turn-off energy	E <sub>off</sub>		-	0.63	-	mJ
Total switching energy	E <sub>total</sub>		-	2.18	-	mJ
Turn-on delay time	td(on)	V <sub>CE</sub> =400V, I <sub>c</sub> =50A, R <sub>G</sub> =10Ω, V <sub>GE</sub> =15V, Parasitic ductance=75nH T <sub>c</sub> =175°C	-	32	-	ns
Turn-On rise time	tr		-	93	-	ns
Turn-Off delay time	td(off)		-	161	-	ns
Turn-Off Fall time	t <sub>f</sub>		-	159	-	ns
Turn-on energy	E <sub>on</sub>		-	1.58	-	mJ
Turn-off energy	E <sub>off</sub>		-	1.61	-	mJ
Total switching energy	E <sub>total</sub>		-	3.19	-	mJ
Total Gate Charge	Q <sub>g</sub>	V <sub>CE</sub> =520V, I <sub>c</sub> =50A V <sub>GE</sub> =15V, T <sub>c</sub> =25°C	-	121	-	nC
Gate to emitter charge	Q <sub>ge</sub>		-	31.6	-	nC
Gate to collector charge	Q <sub>gc</sub>		-	51.3	-	nC
Gate resistance	R <sub>g</sub>		f=1 MHz, open collector	-	2.0	-
<b>Anti-Parallel Diode Characteristics and Maximum Ratings</b>						
Drain-Source Diode Forward Voltage	V <sub>F</sub>	V <sub>GE</sub> =0V, I <sub>F</sub> =20A	-	1.7	2.4	V
Diode Reverse recovery time	t <sub>rr</sub>	V <sub>GE</sub> =0V, V <sub>R</sub> =400V I <sub>F</sub> =50A di=dt=200A/us (note 4) T <sub>c</sub> =25°C	-	20.2	-	ns
Reverse recovery charge	Q <sub>rr</sub>		-	13.9	-	nC
Diode Reverse recovery Current	I <sub>R<sub>RM</sub></sub>		-	16.1	-	A

Diode Reverse recovery time	$t_{rr}$	$V_{GE}=0V, V_R=400V$ $I_F=50A$ $di/dt=200A/us$ (note 4) $T_C=175^\circ C$	-	128	-	ns
Reverse recovery charge	$Q_{rr}$		-	380	-	nC
Diode Reverse recovery Current	$I_{RRM}$		-	33	-	A

### Thermal Characteristic

Paramer	Symbol	Max	Unit
Thermal Resistance,Junction to Case	$R_{th(j-c)}$	0.343	$^\circ C/W$
Thermal Resistance,Junction to Ambient	$R_{th(j-A)}$	34.72	$^\circ C/W$

Notes:

- 1: Pulse width limited by maximum junction temperature
- 2: Pulse Test: Pulse Width  $\leq 300\mu s$ , Duty Cycle  $\leq 2\%$
- 3: Essentially independent of operating temperature

**Electrical Characteristics (curves)**

**Output Characteristics (25°C)**

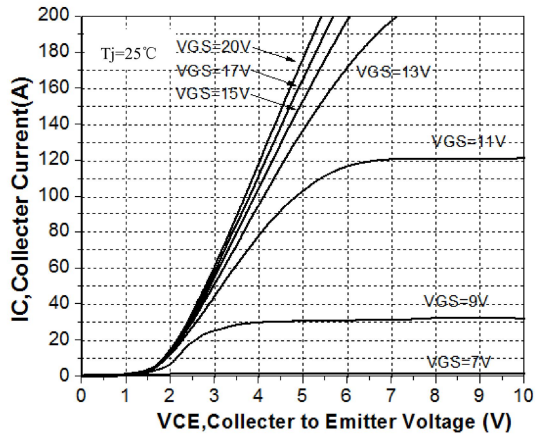

**Output Characteristics (175°C)**

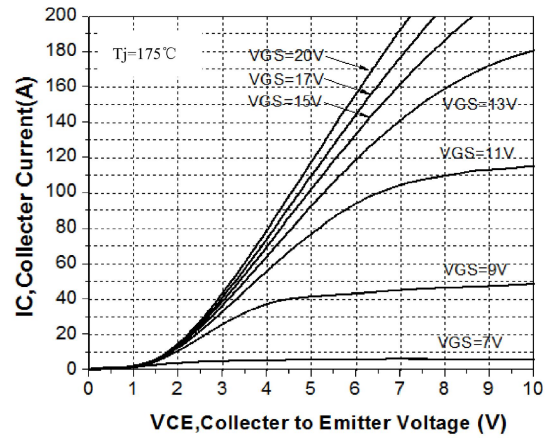

**Transfer Characteristics**

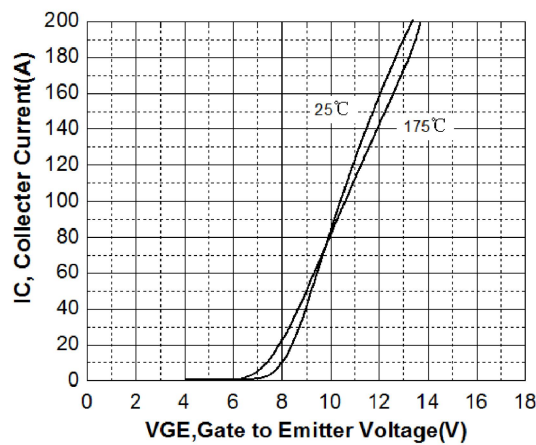

**Vcesat vs. Tj**

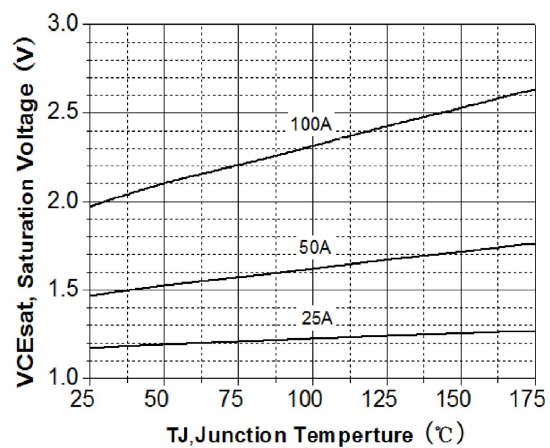

**VF vs. Tj**

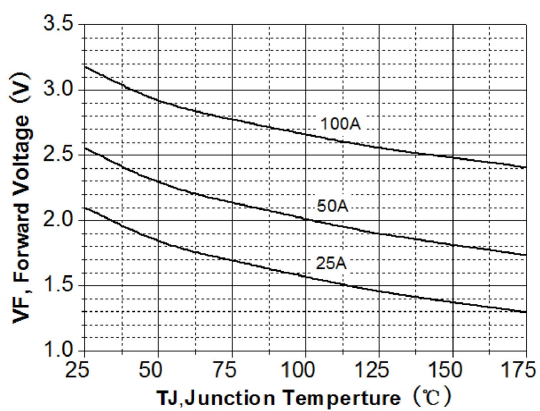

**VTH vs. Tj**

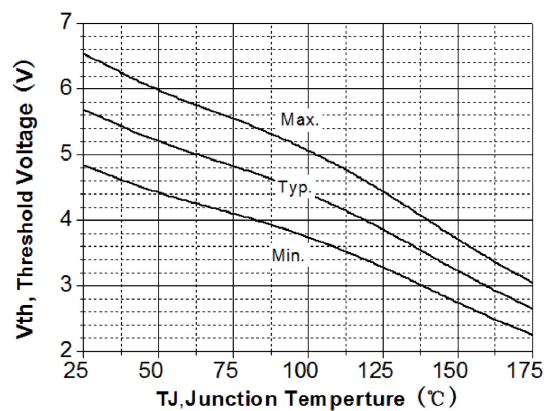

### Diode Characteristic

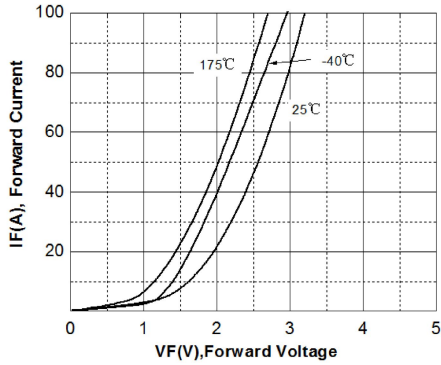

### Collector current vs. case temperature

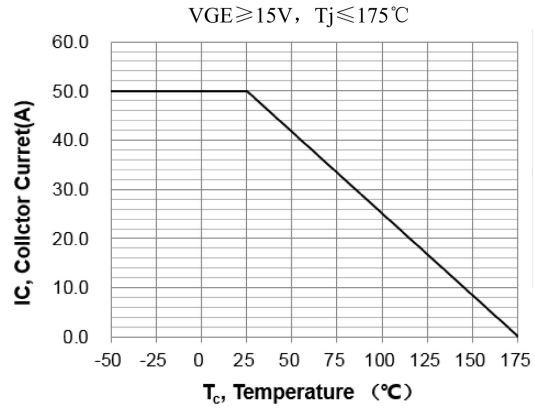

### Gate Charge Characteristics

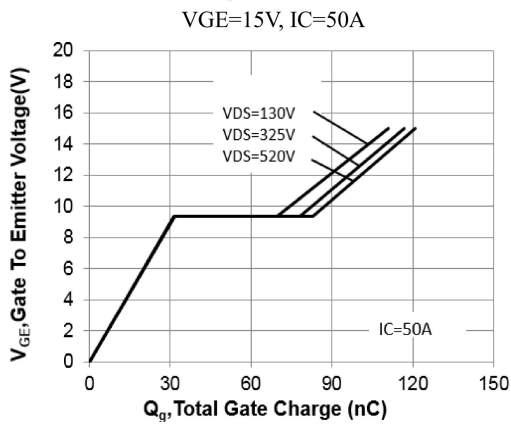

### Capacitance Characteristic

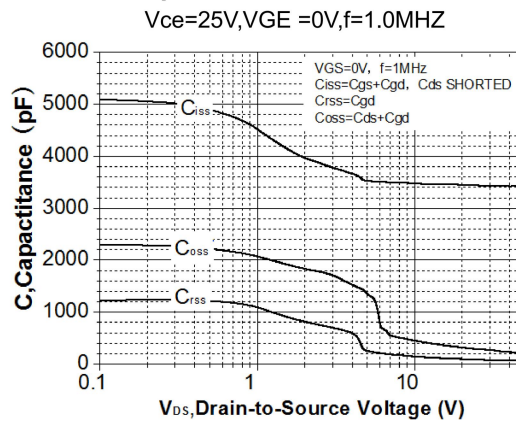

### Switching Time vs. IC(25°C)

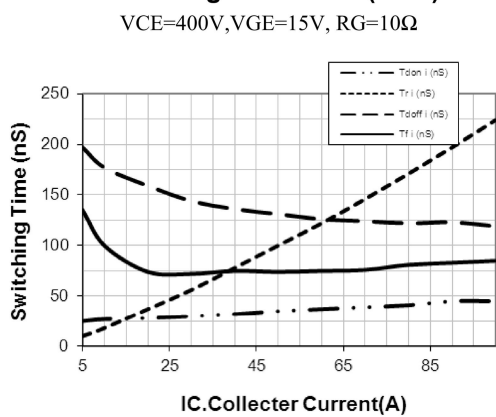

### Switching Time vs. IC(175°C)

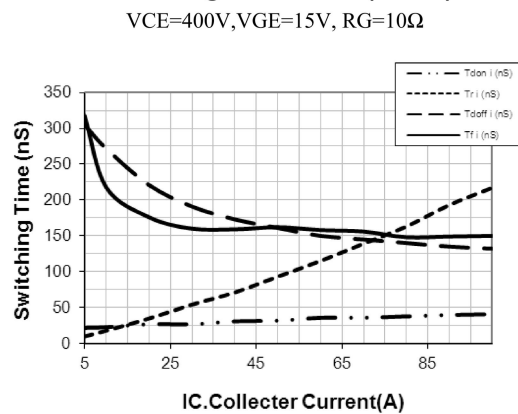

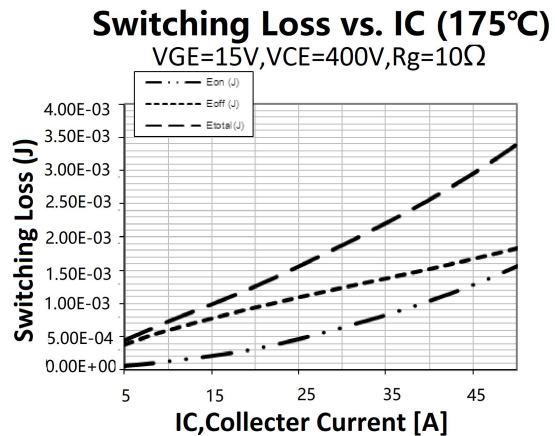
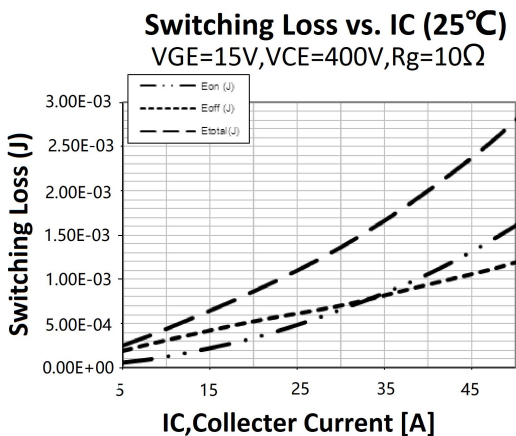
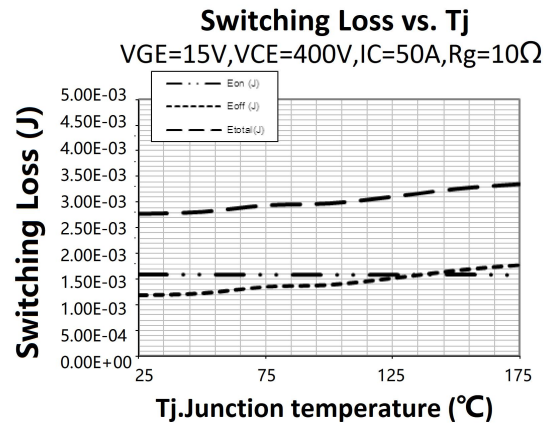
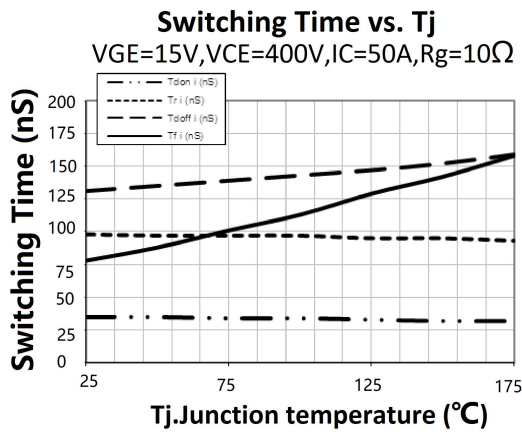
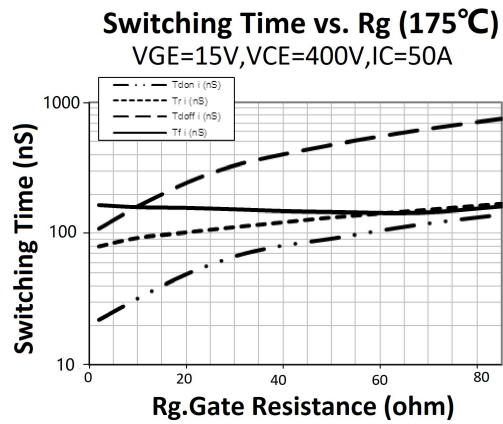
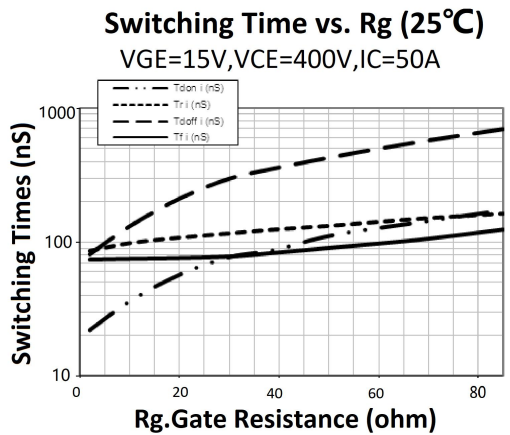

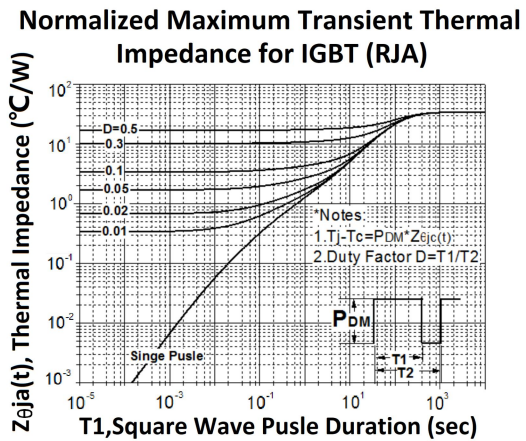
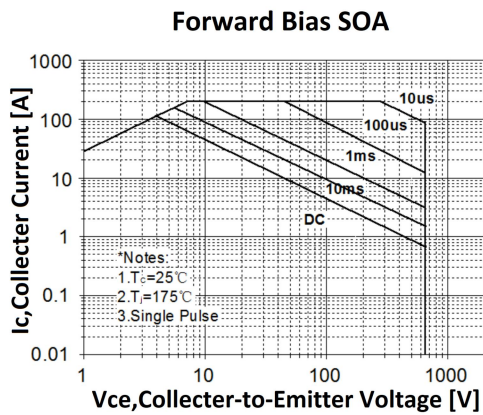
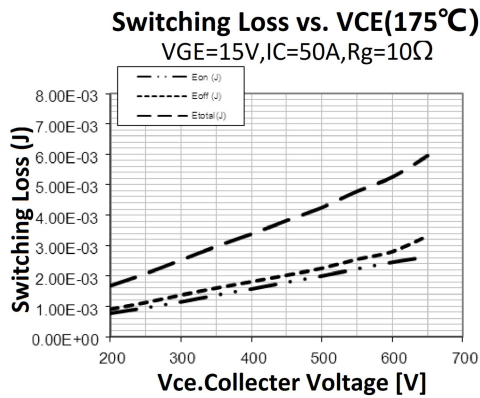
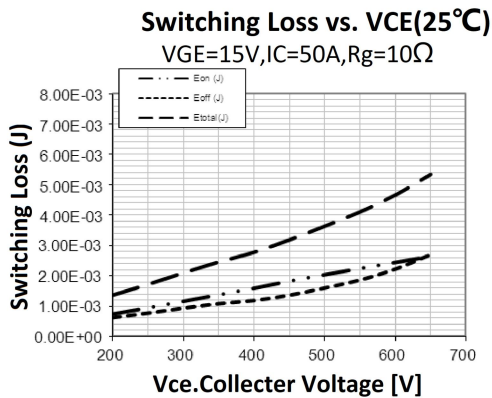
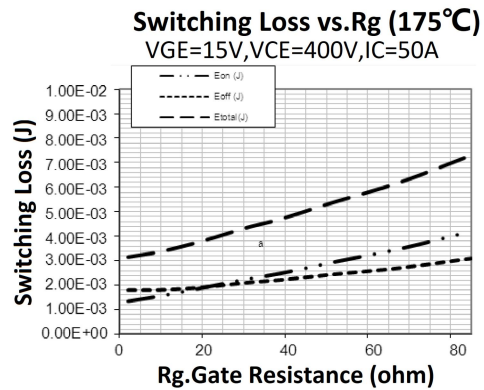
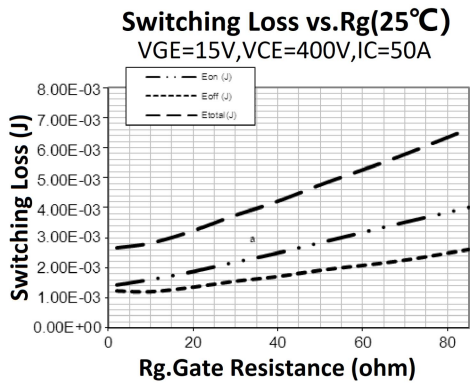



Normalized Maximum Thermal Impedance for IGBT (RJC)

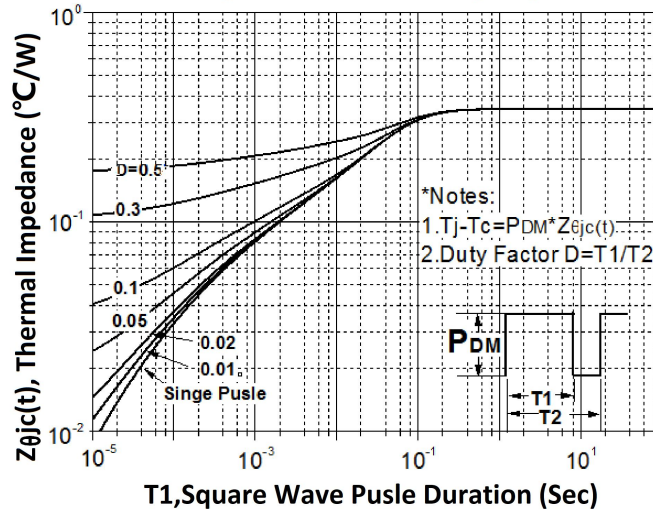

Package Mechanical DATA

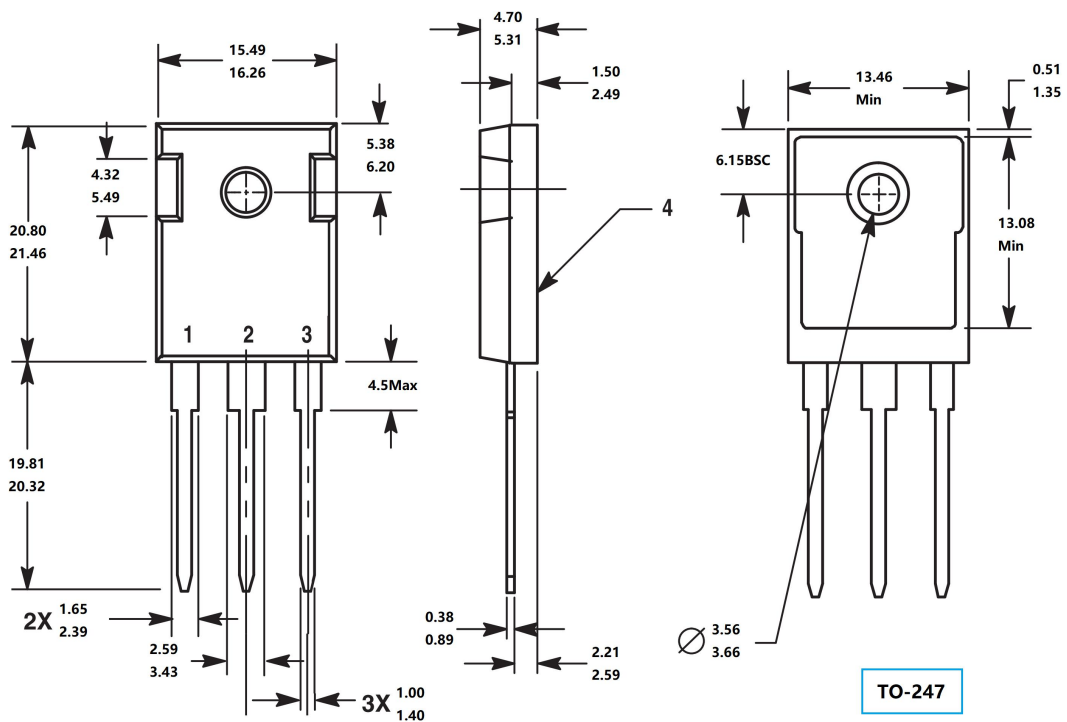

## X-ON Electronics

Largest Supplier of Electrical and Electronic Components

*Click to view similar products for [MASPOWER](#) manufacturer:*

Other Similar products are found below :

[EST100BN120SN](#) [EST100BN60SN](#) [EST60BN120SN](#) [ESTF100SS60S](#) [ESTF15SS120C](#) [ESTF15SS135UC](#) [ESTF15SS60SC](#) [ESTF25D20SB](#)  
[ESTF30S120U](#) [ESTF30SS60SC](#) [ESTF45D60U](#) [ESTF60SS120US](#) [ESTF60SS60US](#) [ESTF75D60U](#) [ESTF80D22U](#) [ESTF8SS120C](#)  
[ESTF8SS195UP](#) [MS100N20HGC0](#) [MS100N20IDC0](#) [MS10N100HGC0](#) [MS10N100HGT1](#) [MS10N120HGC0](#) [MS10N40HGT0](#) [MS10N60FT](#)  
[MS120N10FT](#) [MS120N15FB](#) [MS120N15FE](#) [MS12N100FC](#) [MS12N100FS](#) [MS12N100FT](#) [MS12N120HGC0](#) [MS12N120HJC0](#)  
[MS13N20HGD0](#) [MS140N30HGB3](#) [MS140N30HGC0](#) [MS15N100HGC0](#) [MS15N100HGT1](#) [MS15N120HGC0](#) [MS170N15IDC0](#)  
[MS170N25HGF4](#) [MS170N65HGF4](#) [MS18N100HGC0](#) [MS18N20FT](#) [MS20N50FS](#) [MS30N100HGC0](#) [MS33N10FT](#) [MS33N20HGC0](#)  
[MS38N65FCC](#) [MS3N06FF](#) [MS3N100HGD0](#)