

注: 本板为禁止运输、复制、编辑文件, 以及用其内容进行交流

REV	ECN NO.	CONTENT	CHK	DATE
-----	---------	---------	-----	------

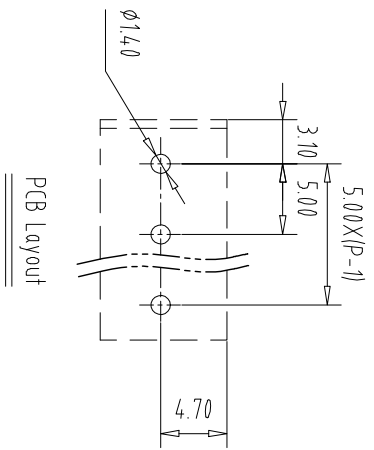
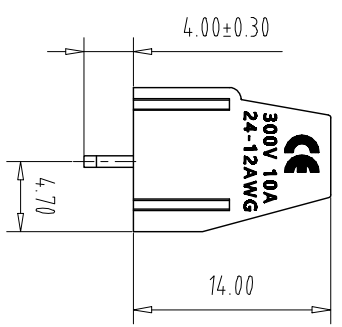
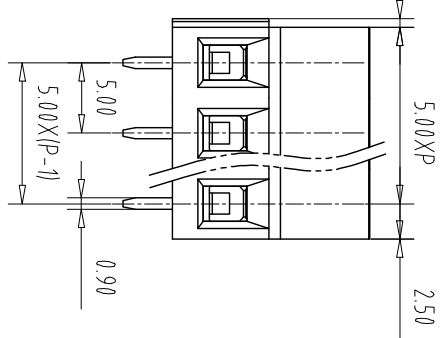
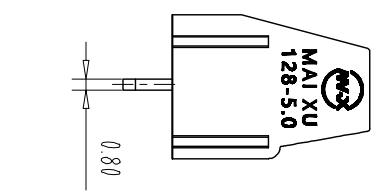
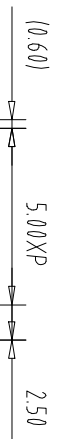
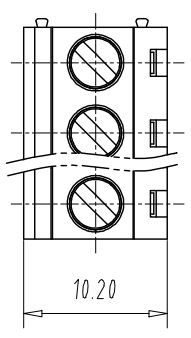

NOTES1:
UL Standard
1.Rating voltage/current: 300V//10A
2.withstanding voltage: AC2000V//1Min
3.Torque value: M2.5, 3.54Lb.in
4.Wire range: 24~12AWG

IEC Standard

1. Pollution Degree	3	2	2
Overvoltage Category	III	III	II
Rate Impulse Voltage(kV)	/	/	/
Rate Voltage(V)	/	250V	/
Rate Current(A)	/	15A	/

- 2. Torque value: M2.5, 0.4Nm
- 3.wire range: 10~2.5mm²

NOTES2:

- 1.Housing: PA66(UL94V-0)
- 2.Solder Pin: Copper alloy(Sn Plated)
- 3.Cage: Brass(Ni Plated)
- 4.Screw: Steel(M2.5,Zn Plated)

NOTES3:

- 1.Pitch: 5.0mm Poles: 02-24P
- 2.Stripping length: 6-7mm
- 3.Operating temperature: -40℃~+105℃
- 4.RoHS Compliance

How to order

MX128 - 5.0 - XXP - XXXX - XX - X - X

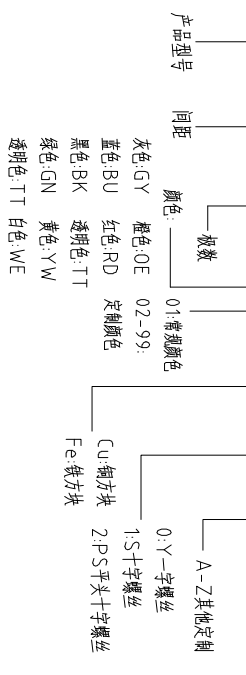

ITEM	NAME OF PART	NO. OF PART	Q'TY	MATERIAL	NOTE
------	--------------	-------------	------	----------	------

DWG	CHK	APP	DATE	SCALE	SHEET/OF	1/1
-----	-----	-----	------	-------	----------	-----

DATE	SCALE	A4	NAME	MX128-5.0-XXP
------	-------	----	------	---------------

CIXI MAIXU ELECTRONICS CO.,LTD
慈溪市迈旭电子有限公司
DWGNO.

Pitch	Range	In	Nominal Dimension	Range		
mm	Over	In mm	Over	Over	Over	Over
	6	10	30	60	100	150
	TO	TO	TO	TO	TO	TO
	6	10	24	30	60	100
	±0.15	±0.20	±0.30	±0.30	±0.50	±0.70
						±1.00
						±1.30
						±2°

X-ON Electronics

Largest Supplier of Electrical and Electronic Components

Click to view similar products for [Fixed Terminal Blocks](#) category:

Click to view products by [MAX](#) manufacturer:

Other Similar products are found below :

[MBE-1512](#) [MBE-1520](#) [MBE-154](#) [MBE-156](#) [MBES-156](#) [MH-2512](#) [MHE-132](#) [MHE-163](#) [MI-254 \(35\)](#) [MI-272](#) [MPT-275](#) [15602-04-08-21](#)
[ELM10110G](#) [BA311TU](#) [BA411SU](#) [MV-254-D](#) [MV-255](#) [MV-493](#) [MVE-252](#) [MVE-253](#) [MVEB-153](#) [1705142](#) [1712417](#) [1713088](#) [1745195](#)
[1760594](#) [1-796689-8](#) [1800114](#) [20020314-C121B01LF](#) [KP03215000J0G](#) [KP04215000J0G](#) [S451](#) [29.007](#) [29.116](#) [30.204](#) [30.503](#) [30.756](#)
[30.853](#) [996750](#) [1710052](#) [1777707](#) [1-796692-3](#) [20020316-G071B01LF](#) [20020327-C061B01LF](#) [29590](#) [30.652](#) [30.710](#) [30.754](#) [30.757](#) [32.058](#)