

注：本板为禁止传输、复制、编辑文件，以及用其内容进行复制

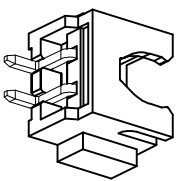
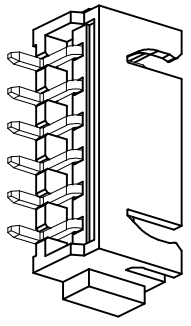
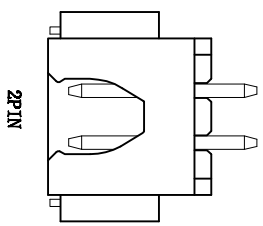
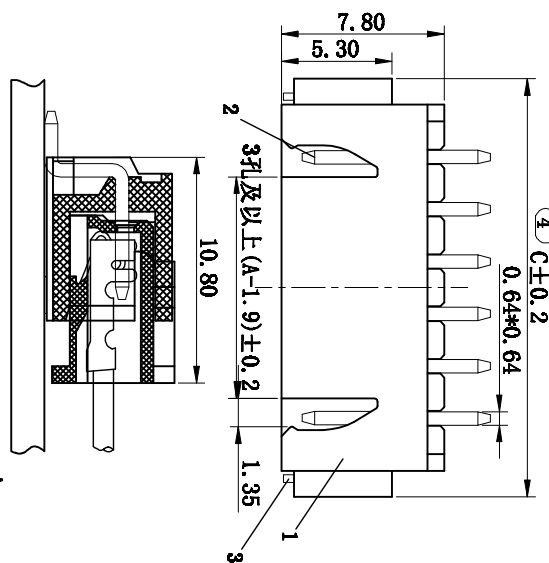
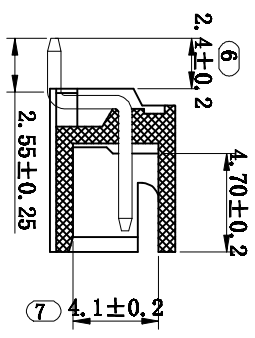
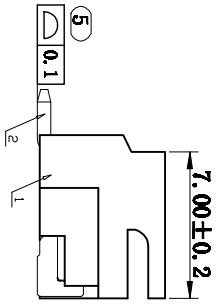
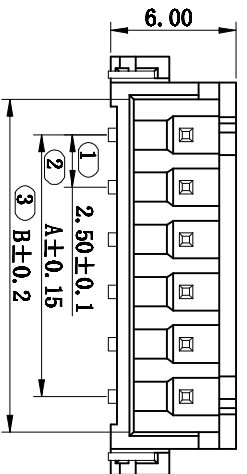

REV	ECN NO.	CONTENT	CHK	DATE	
		孔位 poles	A	B	C
		2	2.5	5.9	10.0
		3	5.0	8.4	12.5
		4	7.5	10.9	15.0
		5	10.0	13.4	17.5
		6	12.5	15.9	20.0
		7	15.0	18.4	22.5
		8	17.5	20.9	25.0
		9	20.0	23.4	27.5
		10	22.5	25.9	30.0
		11	25.0	28.4	32.5
		12	27.5	30.9	35.0
		13	30.0	33.4	37.5
		14	32.5	35.9	40.0
		15	35.0	38.4	42.5
		16	37.5	40.9	45.0

- 技术指标:
- 1、塑件表面应光洁、无毛刺、明显收缩、缺陷、裂纹等现象;
 - 2、温度范围: -25°C~+85°C;
 - 3、额定电压: 250V, AC, DC(等效);
 - 4、额定电流: 3A(24H);
 - 5、接触电阻: $\leq 0.03\Omega$;
 - 6、绝缘电阻: $\geq 1000M\Omega$;
 - 7、耐压: 1000V, AC/minute.

- ROHS 有害物质:
- 1、禁止使用含有ROHS指令所限制的物质。
 - 2、对应的SSS/STS出具的ICP-MS数据和、不可测定物质的限分表，有效期一年。

How to order

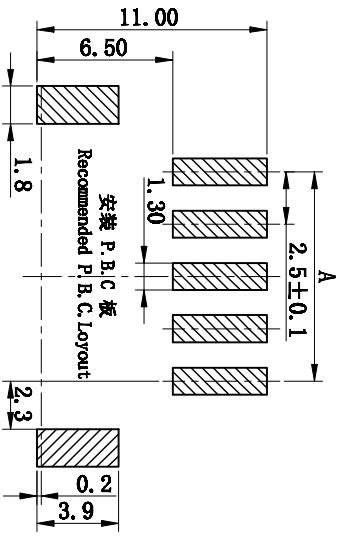
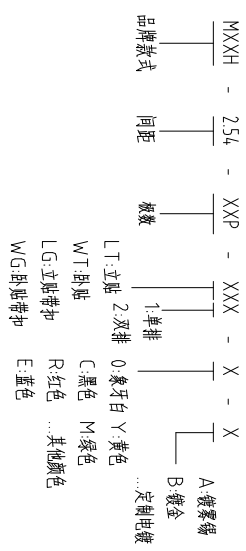

GENERAL TOLERANCES

0.X	±0.25	X' ±3°
0.XX	±0.12	
0.XXX	±0.05	X.X' ±0.5°

序号	名称	材料	数量	附注
1	基 Wafer	LCP (UL94V-0)	1	
2	铜 Contact	铜	n*1	
3	铜 fitting	铜		

ITEM	NAME OF PART	NO. OF PART	Q'TY	MATERIAL	NOTE
DWG	CHK	DATE	UNITS	SHEET/OF	1/1
DATE	DATE	SCALE	MM	A4	
APP	NAME	MXXH-254-XXP-WT1			

CIXI MAXXU ELECTRONICS CO.,LTD
慈溪市迈旭电子有限公司

X-ON Electronics

Largest Supplier of Electrical and Electronic Components

Click to view similar products for [Headers & Wire Housings](#) category:

Click to view products by [MAX](#) manufacturer:

Other Similar products are found below :

[57102-F02-18ULF](#) [58102-G61-06LF](#) [582553-1](#) [009176003701906](#) [01.001.5753.1](#) [0050291907](#) [02.125.8002.8](#) [609-3404](#) [61062-3](#)
[CSU011177004](#) [622-0430](#) [622-3653LF](#) [63453-116](#) [636-1030](#) [636-1427](#) [636-3427](#) [636-4007](#) [641938-9](#) [644827-2](#) [65495-038](#) [65692-001LF](#)
[65781-018](#) [65781-047](#) [65817-010LF](#) [65817-015LF](#) [66207-023LF](#) [67095-007LF](#) [67601157](#) [68631-112](#) [68645-018](#) [699319-000](#)
[M90C108951C](#) [70.362.1628.0](#) [70-4210](#) [70-4226B](#) [70-4853B](#) [707-5028](#) [71.350.2428.0](#) [71961-016LF](#) [733-134](#) [733-162](#) [754199-000](#) [760-](#)
[3052](#) [80.063.4001.1](#) [800-90-001-10-001000](#) [800-90-010-10-002000](#) [801-43-002-10-013000](#) [801-43-006-10-002000](#) [803-41-018-10-001000](#)
[803-43-024-10-001000](#)