

## 1 DESCRIPTION

The MT5725 is an SoC (System on Chip) for magnetic induction based wireless power receiver.

It is fully compliant with the latest WPC Qi specification (Version 1.2.4) of BPP (Baseline Power Profile) and EPP (Extended Power Profile) and also supports various proprietary fast charging protocols used by major smart phone OEM's. It is capable of true fast wireless charging for up to 30W of delivered power with fully programmable output voltage (maximum 20V) and current limit (maximum 2A).

MT5725 has a very high overall AC to DC conversion efficiency (up to 97%), thanks to the optimized and adaptive full synchronous rectifier control, very small R<sub>dson</sub> of power MOSFET's, and extremely low bias current.

With the exception of a few external passive components, this SoC integrates everything that is needed for a wireless power receiving function. It is composed of an ARM Cortex M0 processor with 8KB SRAM and 16KB OTP, full synchronous rectifier and special output LDO, robust and reliable over voltage, over current and over temperature protection circuits, bi-directional communication unit and various GPIO's and serial interfaces.

With the flexibility of SoC architecture and the unique implementation, the MT5725 is future proof in supporting WPC Qi specification's further updates and new proprietary protocols. It also supports reverse charging mode where a wireless power receiver is configured into a wireless power transmitter by firmware control.

## 2 FEATURES

- Up to 30W power delivery
- Fully programmable output voltage (up to 20V) and current limit (up to 2A)
- Embedded ARM Cortex M0 processor with 8KB SRAM and 16KB OTP
- Up to 97% AC input to DC output efficiency
- Reverse charging mode with integrated dual channel TX demodulation
- Fully integrated bi-directional current sensing
- Reliable and unique over voltage, current, temperature protection
- Specially designed output LDO with output clamping and fast response to line and load transient
- WPC compliant and proprietary communication protocols support with hardware ASK and FSK modulation and demodulation
- Independent I2C slave and I2C master interface with additional GPIO's
- 2.48mm x 3.87mm (6x9 ball array) WLCSP

## 3 APPLICATIONS

- Standard and fast wireless charging for smart phones with up to 30W received power
- Wireless charging for wearable devices with high integration and small form factor
- TRx function for phones or power banks where they can be wirelessly charged and wirelessly charge other devices
- Other wireless power applications

4 TYPICAL APPLICATION CIRCUIT

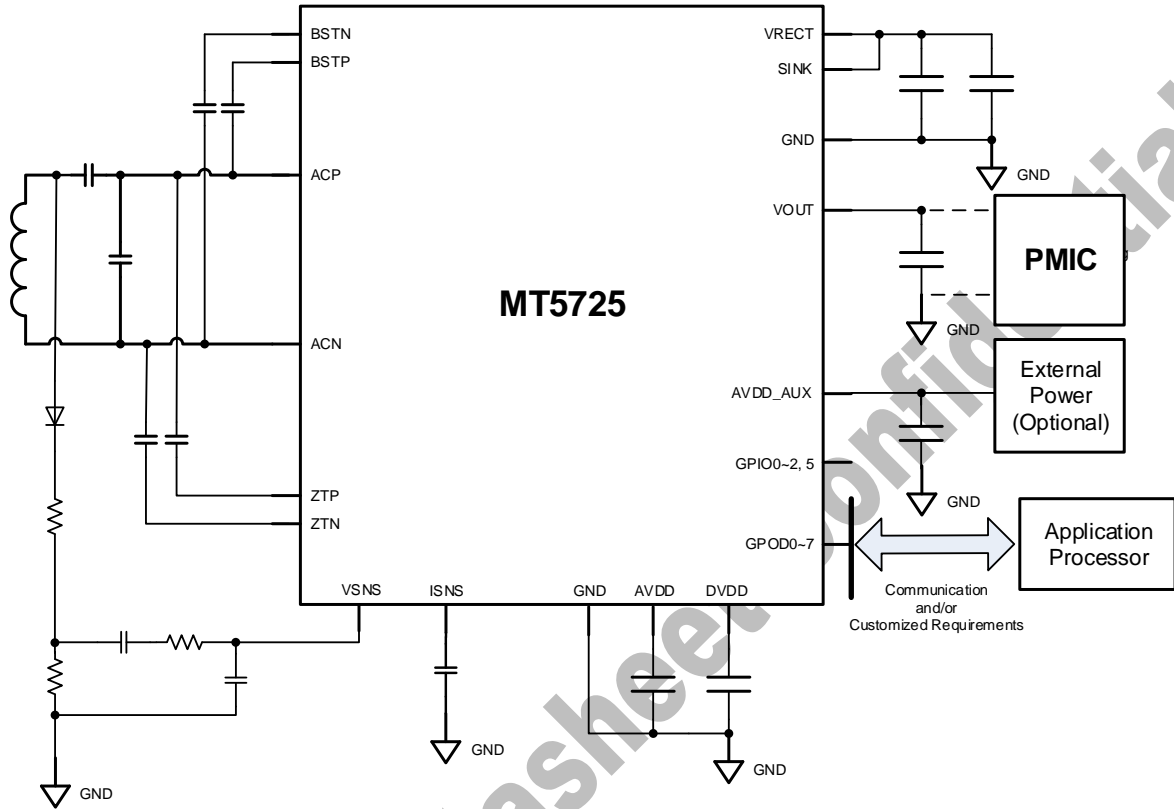

Preliminary Datasheet

## 5 PIN CONFIGURATIONS AND FUNCTIONS

### 5.1 WLCSP Pin Configurations

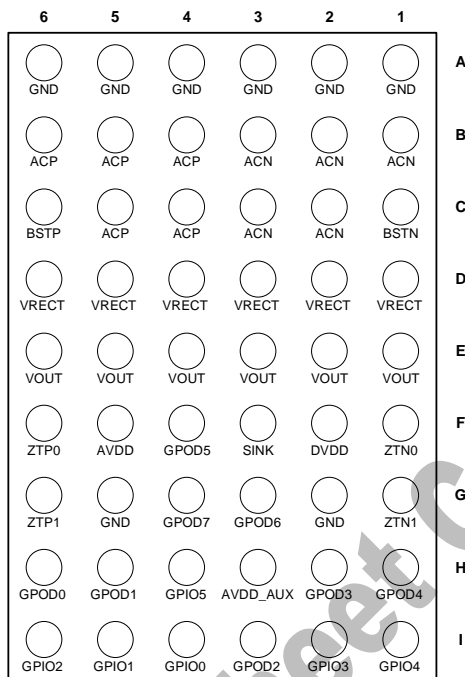

Bottom View (pin/ball side)

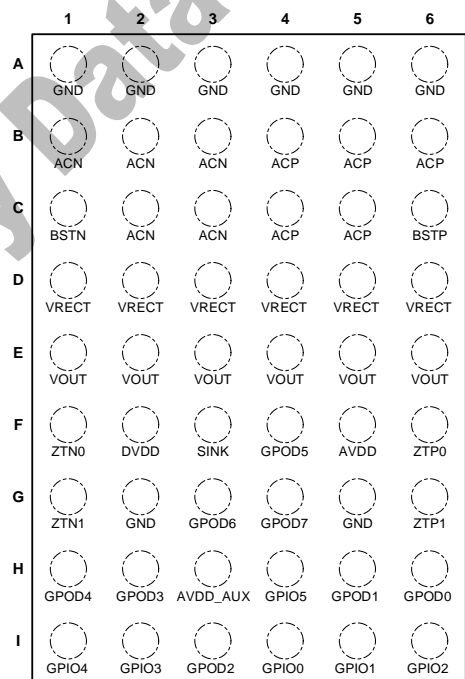

Top View (marking side)

**5.2 Pin Functions**

Pin Name	Pin No.	Description
ACN	B1,B2,B3,C2,C3	AC input, connect to one end of the coil.
ACP	B4,B5,B6,C4,C5	AC input, connect to the other end of the coil.
GND	A1,A2,A3, A4,A5,A6,G2,G5	Power Ground.
VRECT	D1,D2,D3,D4,D5,D6	Output of Synchronous Rectifier.
VOUT	E1,E2,E3,E4,E5,E6	Output of LDO.
SINK	F3	Providing sinking current.
BSTP	C6	Boost Capacitor for internal driver for synchronous bridge rectifier at ACP.
BSTN	C1	Boost Capacitor for internal driver for synchronous bridge rectifier at ACP.
ZTP0	F6	ASK Modulation FET at ACP.
ZTN0	F1	ASK Modulation FET at ACN.
ZTP1	G6	ASK Modulation FET at ACP.
ZTN1	G1	ASK Modulation FET at ACN.
AVDD	F5	Internal 5V Power Supply.
DVDD	F2	Internal 1.8V Power Supply.
AVDD_AUX	H3	5V Auxiliary Power Supply
GPOD0~7	H6, H5, I3, H2, H1, F4, G3, G4	General Purpose I/O. Type: Open Drain. For more details, see Section 5.3.
GPIO0~5	I4, I5, I6, I2, I1, H4	General Purpose I/O. Type: Push/Pull. For more details, see Section 5.3.

### 5.3 I/O Pin Default Configurations

GPOD0~7	
GPOD0:	Power good. This is to indicate to AP that wireless power is ready.
GPOD1:	Interrupt. This is interrupt from wireless power to AP.
GPOD2:	General GPIO.
GPOD3:	I <sup>2</sup> C slave SCL.
GPOD4:	I <sup>2</sup> C slave SDA.
GPOD5:	General GPIO.
GPOD6:	General GPIO.
GPOD7:	General GPIO.
Note: GPOD0~7 can be re-configured upon customer's request.	

GPIO0~5	
GPIO0:	I <sup>2</sup> C master SCL.
GPIO1:	I <sup>2</sup> C master SDA.
GPIO2:	General GPIO, ADC.
GPIO3:	General GPIO. Note: Dedicated current sense for Tx demodulation.
GPIO4:	General GPIO. Note: Dedicated voltage sense for Tx demodulation.
GPIO5:	General GPIO, ADC.
Note: GPIO0~5 can be re-configured upon customers' request.	

## 6 SPECIFICATIONS

### 6.1 Absolute Maximum Ratings

ACN, ACP, ZTP0, ZTN0, ZTP1, ZTN1	-0.3V to 30V
BSTP, BSTN	-0.3V to ACP+6V, ACN+6V
VRECT, SINK	-0.3V to 30V
VOUT	-0.3V to 30V
AVDD, AVDD_AUX	-0.3V to 6V
GPOD0~7, GPIO0~5	-0.3V to 6V
DVDD	-0.3V to 2V
Storage Temperature	-55°C to 150°C
Maximum Soldering Temperature(Reflow, Pb-Free)	260°C

### 6.2 ESD Ratings

Test Model	Pins	Ratings
HBM	All pins	(TBD) V
CDM	All pins	(TBD) V

### 6.3 Recommended Operating Conditions

Operating Temperature(Environment)	-40°C ~85°C
Operating Current (Iout)	0 ~ 1.5A
Operating Voltage (Vrect)	3.5V ~ 20V

### 6.4 Thermal Information (Package Thermal Data)

Junction to ambient (R <sub>θJA</sub> )	50°C/W
---	--------

**6.5 Electrical Characteristics**

 (Test conditions:  $V_{RECT}=12V$ ,  $T_A=25^{\circ}C$ , unless otherwise stated.)

Symbol	Parameter	Conditions	Min	Typ	Max	Unit
<b>Start-up (VDD pin)</b>						
UVLO	Under Voltage Lockout	VRECT rising from 0V		2.95		V
UVLO_HYS	Under Voltage Lockout Hysteresis	VRECT falling		200		mV
<b>Supply Current</b>						
$I_q$	Quiescent Current			6		mA
<b>Bridge Rectifier</b>						
Rds(on)	Rds(on) of Power MOSFETs			40		m $\Omega$
<b>Over-Voltage Protection</b>						
$V_{OVP-DC}$	DC Over-Voltage Protection(programmable)	Rising voltage			30	V
LSB_Vovp	Least Significant Bitat OVP			550		mV
<b>LDO</b>						
VOUT	Output Voltage Regulation	Vrect = 8V, Iout = 0A		5		V
LSB_VOUT	Least Significant Bit when programming output voltage			25		mV
Programming_Range				3~20		V
ILimit_max	Output Current Limit				2	A
LSB_ILimit	Least Significant Bit when programming output current limit			25		mA
<b>ADC</b>						
N	Resolution			12		Bit
$f_{sample}$	Sampling Rate			100		kS/s
Channel	Number of Channels			8		
<b>Miscellaneous</b>						
AVDD	AVDD Output Voltage			5		V
AVDD_AUX	AVDD Auxiliary Input Voltage		4.5			V
DVDD	DVDD Output Voltage			1.8		V
<b>Digital I/O Pins</b>						
GPOD0~7	HIGH Level Input Voltage $V_{IH}$		1.26			V
	LOW Level Input Voltage $V_{IL}$				0.54	V
	LOW Level Output Voltage $V_{OL}$			0		V
	LOW Level Output Current $I_{OL}$	Test at $V_{OL}=0.4V$	2/8	4.4/17 <sup>①</sup>		mA
	Analog Input Range			0~2.4		V
GPIO0~5	HIGH Level Input Voltage $V_{IH}$		3.5			V
	LOW Level Input Voltage $V_{IL}$				1.5	V
	HIGH Level Output Voltage $V_{OH}$			5		V



	LOW Level Output Voltage $V_{OL}$			0		V
	HIGH Level Output Current $I_{OH}$	Test at $V_{OH}=4V$	2/8	7.8/29 <sup>①</sup>		mA
	LOW Level Output Current $I_{OL}$	Test at $V_{OL}=0.4V$	2/8	4.4/17 <sup>①</sup>		mA
	Analog Input Range			0~5		V

Note<sup>①</sup>: Digital I/O pin output current can be programmed.

Preliminary Datasheet Confidential



### 6.6 Typical Operating Characteristics

The following performance characteristics were taken using MT5815 wireless power transmitter at  $T_A=25^\circ\text{C}$ , unless otherwise noted.

Figure1. Efficiency vs. Output Load:  $V_{out}=5V$

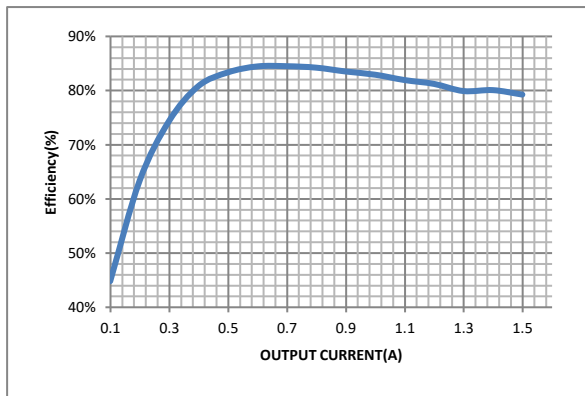

Figure2. Efficiency vs. Output Load:  $V_{out}=9V$

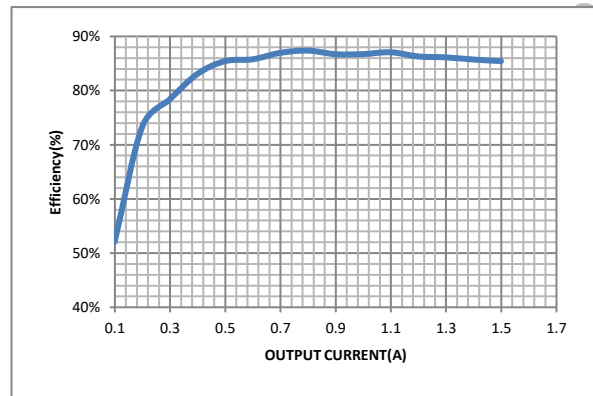

Figure3. Efficiency vs. Output Load:  $V_{out}=12V$

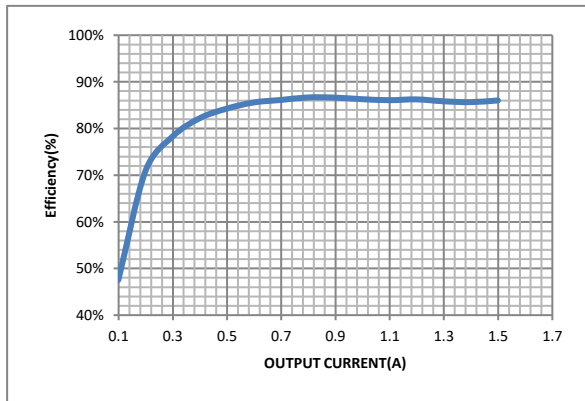

Figure4. Efficiency vs. Output Load:  $V_{out}=15V$

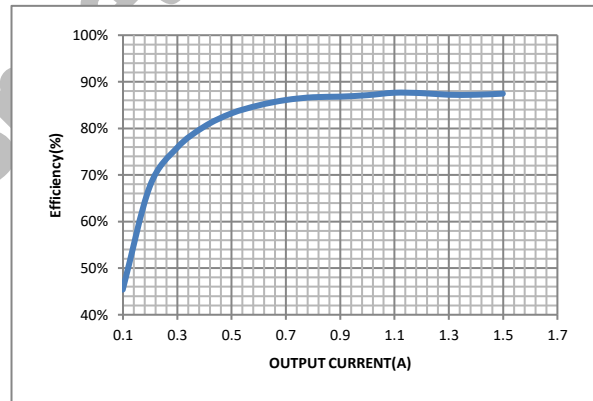

Figure5. Efficiency vs. Output Load:  $V_{out}=18V$

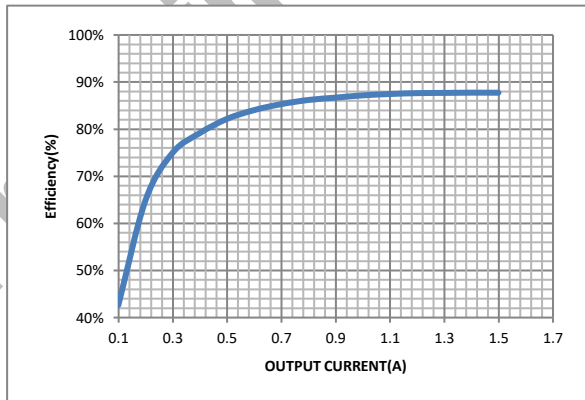

Figure6. Efficiency vs. Output Load:  $V_{out}=20V$

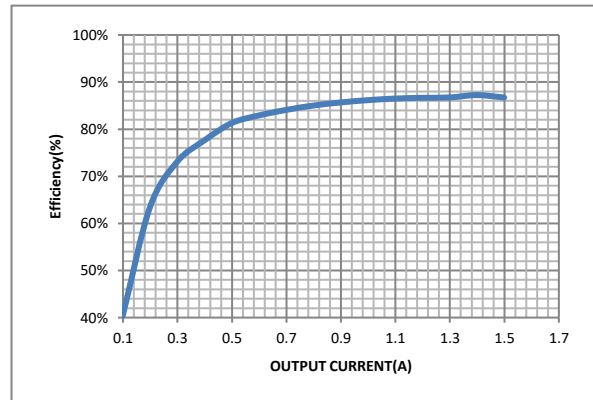

Figure7. Load Reg. vs. Output Load:  $V_{out}=5V$

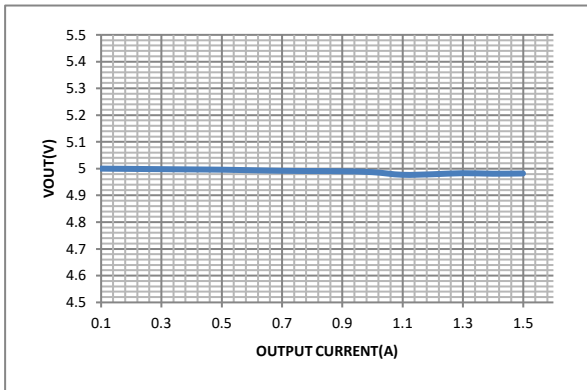
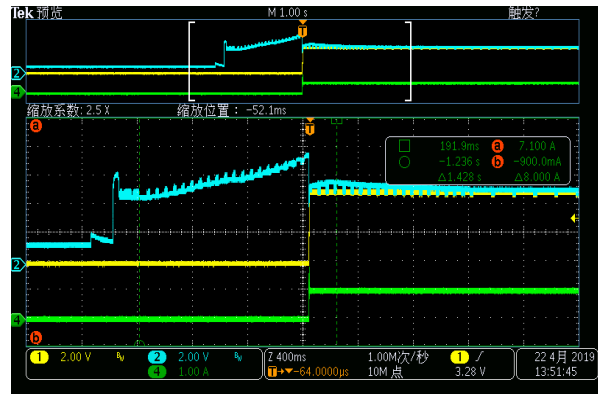

Figure8. Enable Startup:  $V_{out}=5V$ ;  $I_{out}=1A$



Preliminary Datasheet Confidential

## **7 DETAILED DESCRIPTIONS**

### **7.1 Overview**

MT5725 is an SoC (System on Chip) for wireless power receiver. It only needs several passive components like power receiving coils, resonant tank capacitors, decoupling capacitors and pull up/down resistors to build a complete wireless power receiver system. When coupled with a wireless power transmitter, this system can provide all the functions for wireless power transfer, including power receiving and rectification, output regulation, communication for power control and data exchange, and abnormal condition (FOD, over voltage, current, temperature, etc.) protection.

MT5725 is by default programmed to be fully compliant with the latest WPC Qi Specification Version 1.2.4 with support of both BPP (Baseline Power Profile) and EPP (Extended Power Profile). It can also be programmed to be compliant with major smart phone vendors' proprietary fast wireless charging protocols.

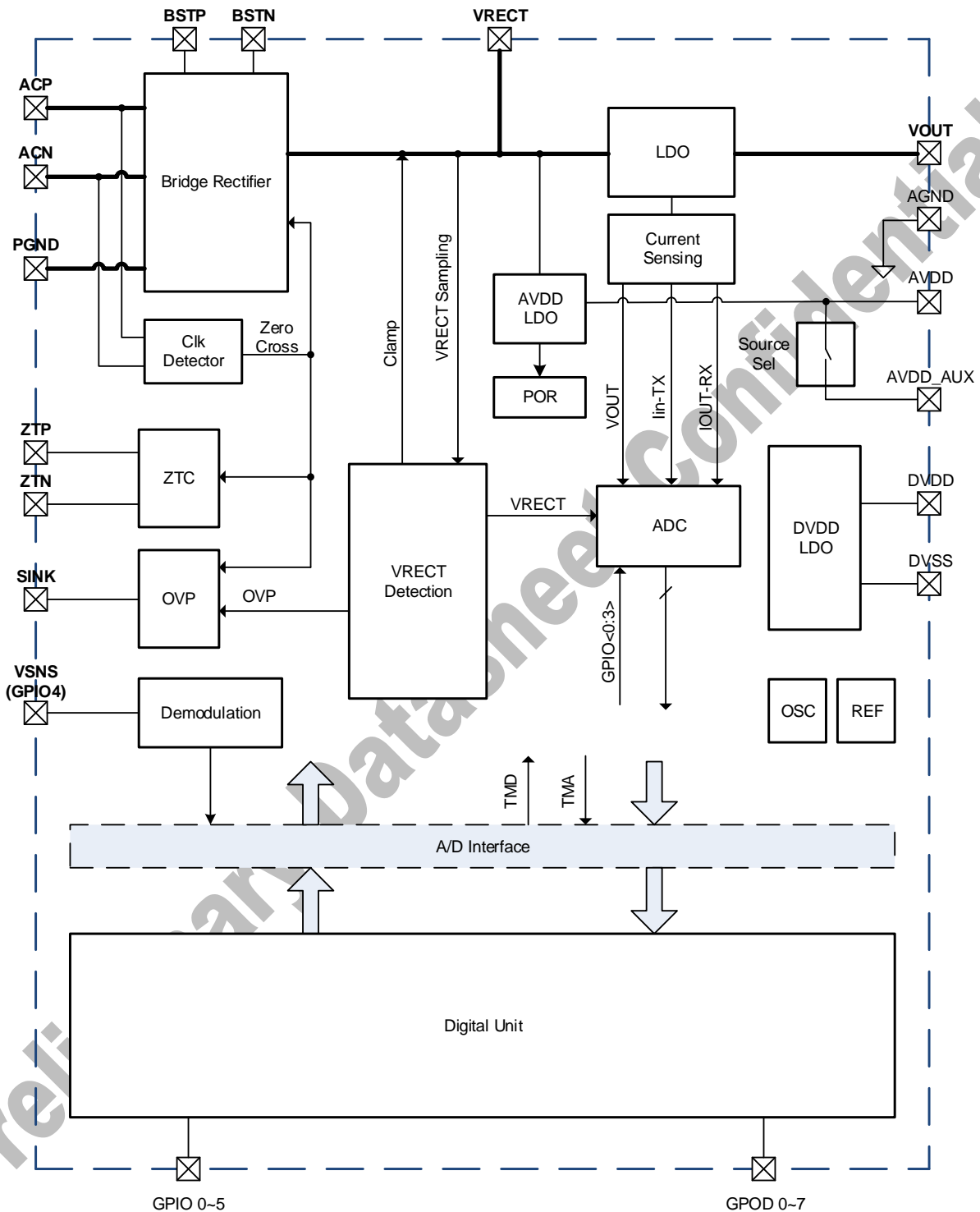
**7.2 Functional Block Diagram**

### 7.3 Theory of Operation

MT5725 is composed of several major functional blocks which together achieve the wireless power receiving function.

Bridge Rectifier, which is also called Full Synchronous Rectifier. This block converts the received AC power from the resonant tank to DC power with the help of the capacitors connected on its output.

LDO, which is also called Main LDO or Output LDO. This block functions as a load switch (connecting and disconnecting the external load), output voltage and current regulation and output clamping when fast load/line transient happens.

AVDD and DVDD LDO and POR. These blocks provide the necessary regulated power supplies from rectifier output for the operation of the chip.

ZTC and CLK Detector. These blocks are for the bi-directional communication for power control and data exchange.

OVP and Vrect Detection. These blocks are for the rectifier output voltage detection and over voltage protection when Vrect is too high.

OSC and REF. These blocks provide the timing reference and voltage reference for the whole chip.

ADC. This block is one of the key blocks that convert various measured analog variables (voltages, currents, temperature, external analog inputs, etc.) to digital domain such that the embedded micro controller can use the information for follow up actions.

Digital Unit. This block contains all the digital circuits, which include embedded micro controller, volatile and nonvolatile memories, I2C interface, peripherals, DMA (Direct Memory Access), internal buses, and other digital functional blocks. This block is the brain of the whole chip which dynamically configures chip for different functions in different state, communicate with the outside world (power transmitter and receiver side external host), and perform necessary data processing for proper operation (like FOD calculation, target Vrect and Vout calculation, etc.)

#### 7.4 Device Function Modes

MT5725 can be programmed to operate in different modes. The switching among these modes can be made automatically based on the types of the transmitter or the instruction from the transmitter the receiver is coupled with. The operation modes can also be programmed by an external host (e.g., an Application Processor in a smart phone) via I2C interface. Here are some of these modes:

- WPC BPP only receiver mode
- WPC BPP and EPP receiver mode
- WPC BPP and proprietary receiver mode
- WPC BPP, EPP and proprietary receiver mode
- WPC proprietary only receiver mode
- WPC BPP transmitter mode
- Proprietary transmitter mode

Preliminary Datasheet Confidential

## 8 APPLICATIONS AND IMPLEMENTATIONS

### 8.1 Reference Schematic

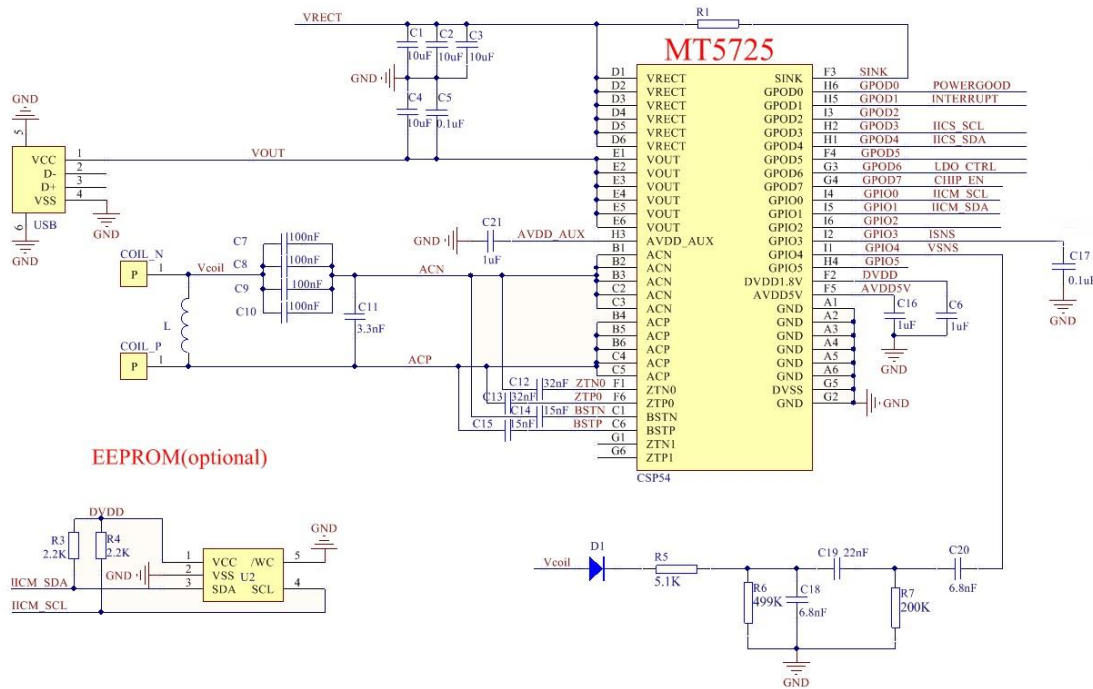

### 8.2 BOM

#	Reference	Value	Description	Footprint	Quanti
1	R1	50R	RES SMD 50R 5% 1/8W	0805	1
2	R3, R4	2.2K	RES SMD 2.2K 5% 1/20W	0201	2
3	R5	5.1K	RES SMD 5.1K 5% 1/20W	0201	1
4	R6	499K	RES SMD 499K 5% 1/20W	0201	1
5	R7	200K	RES SMD 200K 5% 1/20W	0201	1
6	C1, C2, C3, C4	10uF	CAP CER 10UF 25V X7R 0603	0603	4
7	C5	0.1uF	CAP CER 0.1UF 25V X7R 0603	0603	1
8	C6,C16,C21	1uF	CAP CER 1UF 6.3V X7R 0201	0201	3
9	C7,C8,C9,C10	100nF	CAP CER 0.1UF 50V X7R 0603	0603	4
10	C11	3.3nF	CAP CER 0.0033UF 50V X7R	0402	1
11	C12,C13	32nF	CAP CER 0.032UF 50V X7R 0402	0402	2
12	C14,C15	15nF	CAP CER 0.015UF 50V X7R 0402	0402	2
13	C17	0.1uF	CAP CER 0.1UF 6.3V X7R 0201	0201	1
14	C18	6.8nF	CAP CER 6.8nF 50V X7R 0201	0201	1
15	C19	22nF	CAP CER 22UF 50V X7R 0201	0201	1
16	C20	6.8nF	CAP CER 6.8nF 6.3V X7R 0201	0201	1
17	D1	BAV21WS	Diode	SOD-123	1



18	U1	MT5725	Wireless power receiver	CSP54	1
19	U2	M24128	EEPROM	UFDFFP	1
				Notes	30

Preliminary Datasheet Confidential





Maximizing IC Performance

A High Efficiency

## 9 DETAILED PACKAGING INFORMATIONS

### 9.1 WLCSP Package Outline and Dimensions

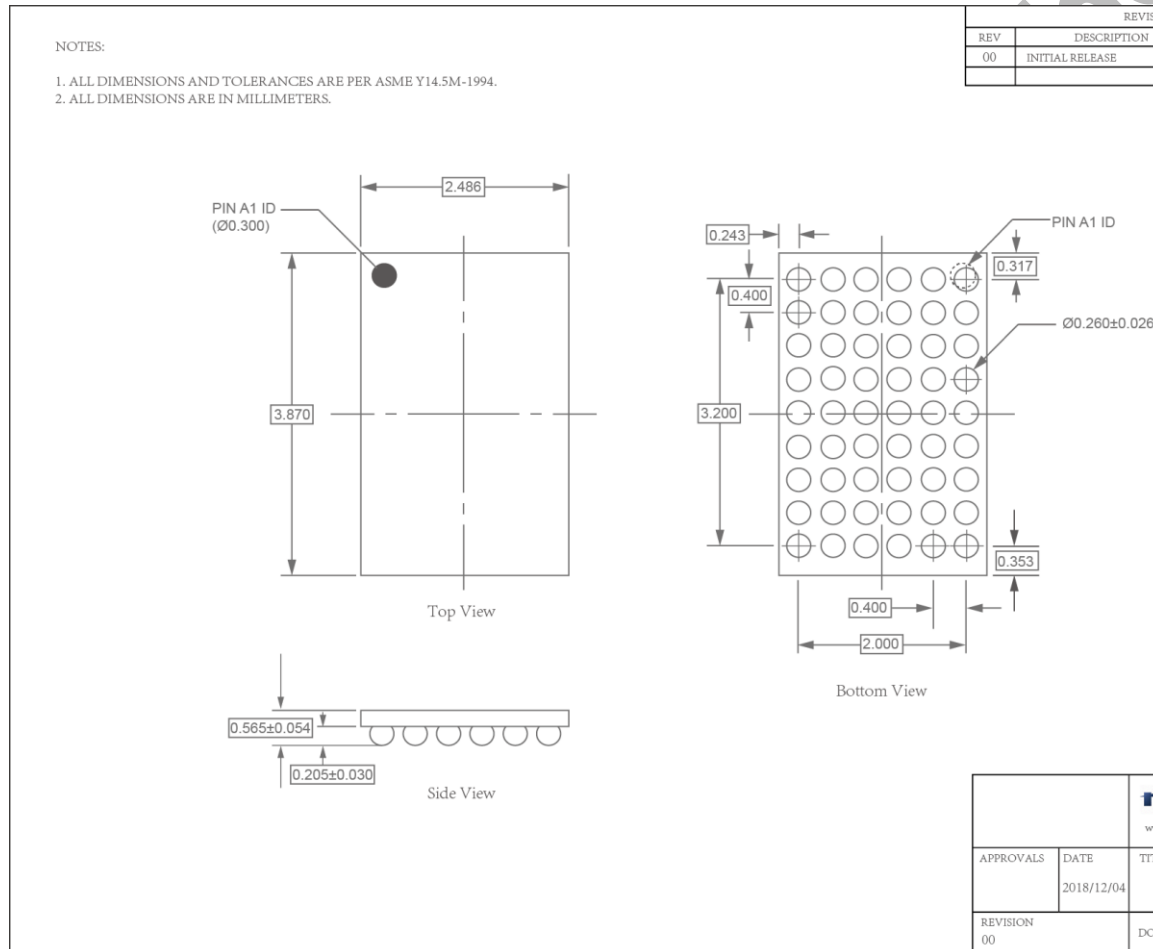

**10 ORDERING INFORMATION**

Part No.	Package Type	Package Information	Package Quantity	Ambient Temperature	Chip Mark
MT5725	WLCSP	2.48 x 3.87mm 54-WLCSP	3000	-40°C~+85°C	 MT5725 YYWWXX XXXX

**11 REVISION HISTORY**

Revision	Date	Description
1.0	2019-04-19	Preliminary version.

**Important Notice**

- Maxic Technology Corporation (Maxic) reserves the right to make correction, modifications, enhancements, improvements and other changes to its products and services at any time and to discontinue any product or service without notice. Customers should obtain the latest relevant information before placing orders and should verify that such information is current and complete. All products are sold subject to Maxic's terms and conditions of sale supplied at the time of order acknowledgement.
- Reproduction, copying, transferring, reprinting this paper without Maxic's written permission is prohibited.
- Maxic assumes no liability for applications assistance or the design of customers' products. Maxic warrants the performance of its products to the specifications applicable at the time of sale. Customers are responsible for their products and applications using Maxic components. To minimize the risks associated with customers' products and applications, customers should provide adequate design and operating safeguards.

## X-ON Electronics

Largest Supplier of Electrical and Electronic Components

*Click to view similar products for [Battery Management](#) category:*

*Click to view products by [MAXIC](#) manufacturer:*

Other Similar products are found below :

[MP2602DQ-LF-P](#) [MP26053DQ-LF-Z](#) [MP2611GL-P](#) [NCP347MTAHTBG](#) [LM3658SD-AEV/NOPB](#) [MP2607DL-LF-P](#) [MP26121DQ-LF-P](#)  
[MP26123DR-LF-P](#) [MP2633GR-P](#) [MP2637GR-P](#) [BQ24212EVM-678](#) [NCP1855FCCT1G](#) [MP2636GR-P](#) [FAN54063UCX](#)  
[MAX14680EWC+T](#) [MAX14634EWC+T](#) [DS2745U+T&R](#) [MAX14578EETE+T](#) [DS2781EVKIT+](#) [DS2781E+T&R](#) [MP2605DQ-LF-P](#)  
[DS2710G+T&R](#) [MAX17040G+T](#) [MAX14525ETA+T](#) [MP2615GQ-P](#) [MAX14578EEWC+T](#) [LC05132C01NMTTTG](#) [MAX8971EWP+T](#)  
[MAX14630EZK+T](#) [MAX1873TEEE+T](#) [PSC5415A](#) [AUR9811DGD](#) [SN2040DSQR](#) [DS2715BZ+T&R](#) [MAX1508ZETA+T](#)  
[MAX14921ECS+T](#) [MAX77301EWA+T](#) [BD8668GW-E2](#) [MAX16024PTBS+T](#) [DS2715Z+T&R](#) [MAX16024LTBZ18+T](#) [DS2782E+T&R](#)  
[DS2782G+T&R](#) [MAX1908ETI+T](#) [ISL95522IRZ](#) [ISL95522HRZ](#) [ARD00558](#) [NCP4371AAEDR2G](#) [BD8665GW-E2](#) [MAX8934EETI+T](#)