

DS1091L

Automotive Temperature Range Spread-Spectrum EconOscillator™

General Description

The DS1091L is a low-cost clock generator that is factory trimmed to output frequencies from 130kHz to 66.6MHz with a nominal accuracy of $\pm 0.25\%$. The device can also produce a center- or down-dithered spread-spectrum output with pin-selectable dither magnitude and rate. Assembled in an 8-pin $\mu\text{MAX}^{\text{®}}$ package, the DS1091L is designed to operate with a 3.0V to 3.6V power supply over the automotive temperature range (-40°C to $+125^{\circ}\text{C}$).

Applications

Automotive Infotainment
POS Terminals
LCD Displays
Printers
Industrial Control

Typical Operating Circuit

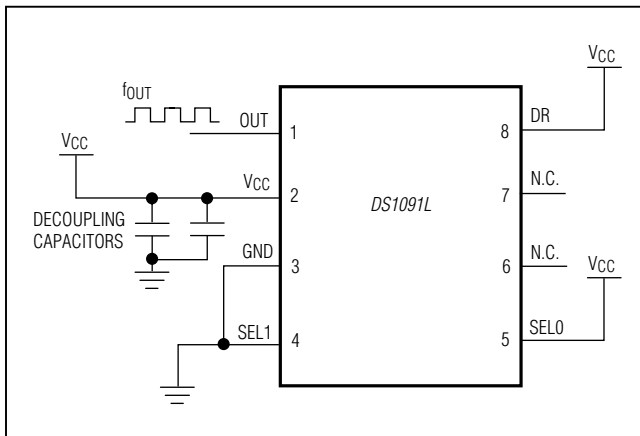

Features

- ◆ Spread-Spectrum Clock Output from 130kHz to 66.6MHz
- ◆ -40°C to $+125^{\circ}\text{C}$ Operating Temperature Range
- ◆ $\pm 1.75\%$ Accuracy Across Temperature and Voltage
- ◆ Factory Trimmed
- ◆ Center-Dithered (DS1091LUA) or Down-Dithered (DS1091LUB) Spread-Spectrum Output
- ◆ Pin-Selectable Center-Dither Magnitude of 0%, $\pm 1\%$, $\pm 2\%$, or $\pm 4\%$
- ◆ Pin-Selectable Down-Dither Magnitude of 0%, -2% , -4% , or -8%
- ◆ Pin-Selectable Dither Rate
- ◆ 3.0V to 3.6V Supply Operation
- ◆ Lead(Pb)-Free, 8-Pin μMAX Package

Custom Frequency Options

Custom frequency options are available. See the [Ordering Information](#) or contact the factory by email at custom_oscillators@maximintegrated.com for more information.

[Ordering Information](#) appears at end of data sheet.

EconOscillator is a trademark and μMAX is a registered trademark of Maxim Integrated Products, Inc.

For related parts and recommended products to use with this part, refer to: www.maximintegrated.com/DS1091L.related

For pricing, delivery, and ordering information, please contact Maxim Direct at 1-888-629-4642, or visit Maxim Integrated's website at www.maximintegrated.com.

DS1091L

Automotive Temperature Range Spread-Spectrum EconOscillator™

ABSOLUTE MAXIMUM RATINGS

Voltage Range on V_{CC} Relative to Ground-0.5V to +6.0V
Voltage Range on DR, SEL0, SEL1
Relative to Ground.....-0.5V to ($V_{CC} + 0.5V$)*
Continuous Power Dissipation ($T_A = +70^\circ\text{C}$)
 μMAX (derate 4.5mW/ $^\circ\text{C}$ above +70 $^\circ\text{C}$)362mW

Operating Temperature Range-40 $^\circ\text{C}$ to +125 $^\circ\text{C}$
Storage Temperature Range.....-55 $^\circ\text{C}$ to +125 $^\circ\text{C}$
Lead Temperature (soldering, 10s)+300 $^\circ\text{C}$
Soldering Temperature (reflow)+260 $^\circ\text{C}$

*This voltage must not exceed 6.0V.

Stresses beyond those listed under "Absolute Maximum Ratings" may cause permanent damage to the device. These are stress ratings only, and functional operation of the device at these or any other conditions beyond those indicated in the operational sections of the specifications is not implied. Exposure to absolute maximum rating conditions for extended periods may affect device reliability.

RECOMMENDED OPERATING CONDITIONS

($T_A = -40^\circ\text{C}$ to +125 $^\circ\text{C}$, unless otherwise noted.)

PARAMETER	SYMBOL	CONDITIONS	MIN	TYP	MAX	UNITS
Supply Voltage	V_{CC}	(Note 1)	3.0	3.3	3.6	V
High-Level Input Voltage (SEL0, SEL1, DR)	V_{IH}		0.7 x V_{CC}		$V_{CC} +$ 0.3	V
Low-Level Input Voltage (SEL0, SEL1, DR)	V_{IL}		-0.3		0.3 x V_{CC}	V

DC ELECTRICAL CHARACTERISTICS

($V_{CC} = +3.0V$ to +3.6V, $T_A = -40^\circ\text{C}$ to +125 $^\circ\text{C}$, unless otherwise noted.)

PARAMETER	SYMBOL	CONDITIONS	MIN	TYP	MAX	UNITS
High-Level Output Voltage (OUT)	V_{OH}	$I_{OH} = -4\text{mA}$, $V_{CC} = 3.0V$	2.4			V
Low-Level Output Voltage (OUT)	V_{OL}	$I_{OL} = 4\text{mA}$			0.4	V
High-Level Input Current (SEL0, SEL1, DR)	I_{IH}	$V_{CC} = 3.6V$			1	μA
Low-Level Input Current (SEL0, SEL1, DR)	I_{IL}	$V_{IL} = 0V$	-1			μA
Supply Current (Active)	I_{CC}	(Note 2)			16	mA

DS1091L

Automotive Temperature Range Spread-Spectrum EconOscillator™

AC ELECTRICAL CHARACTERISTICS

($V_{CC} = +3.0V$ to $+3.6V$, $T_A = -40^{\circ}C$ to $+125^{\circ}C$, unless otherwise noted.)

PARAMETER	SYMBOL	CONDITIONS	MIN	TYP	MAX	UNITS
Output Frequency Range	f_{OUT}	(Note 3)	0.130		66.6	MHz
Output Center Frequency Tolerance	Δf_{OUT}	$V_{CC} = 3.3V$, $T_A = +25^{\circ}C$	-0.25	0	+0.25	%
		Across T_A and V_{CC}	-1.75		+1.75	
		$0^{\circ}C$ to $+70^{\circ}C$, across V_{CC}	-1.2		+1.2	
Power-Up Time	t_{PU}	(Note 4)			0.1	ms
Load Capacitance	C_L			15	50	pF
Duty Cycle		< 33.3MHz (Note 3)		50		%
		$\geq 33.3MHz$ (Note 3)	40		60	
Jitter (RMS), 50MHz				0.3		%

Note 1: All voltages are referenced to ground. Currents entering the IC are specified positive and currents exiting the IC are negative.

Note 2: Supply current measured with $C_L = 15pF$, $V_{CC} = 3.6V$, $T_A = +25^{\circ}C$, $f_{OUT} = 66.6MHz$, no dither.

Note 3: No dither.

Note 4: Guaranteed by design.

Note 5: For aging characteristics, contact factory.

Typical Operating Characteristics

($V_{CC} = 3.3V$, $T_A = +25^{\circ}C$, unless otherwise noted.)

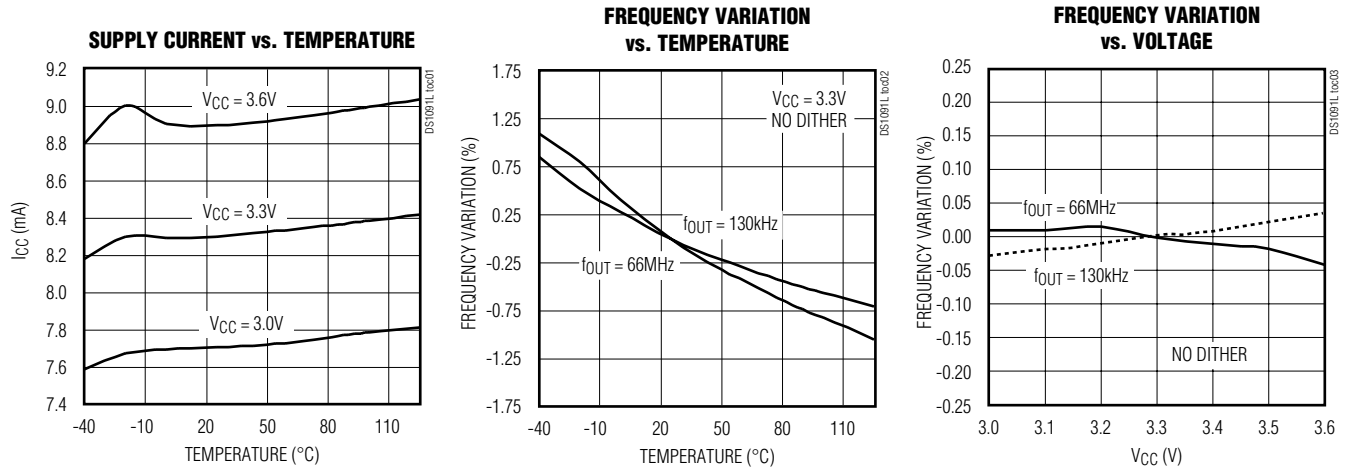

DS1091L

Automotive Temperature Range Spread-Spectrum EconOscillator™

Typical Operating Characteristics (continued)

($V_{CC} = 3.3V$, $T_A = +25^\circ C$, unless otherwise noted.)

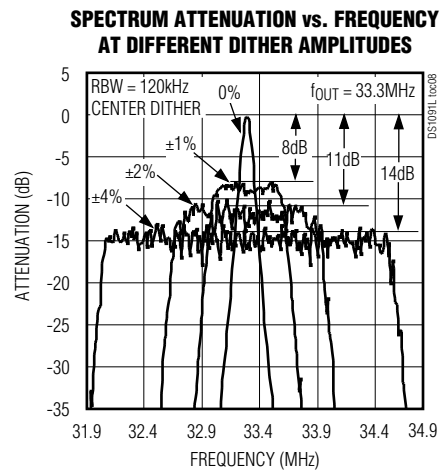
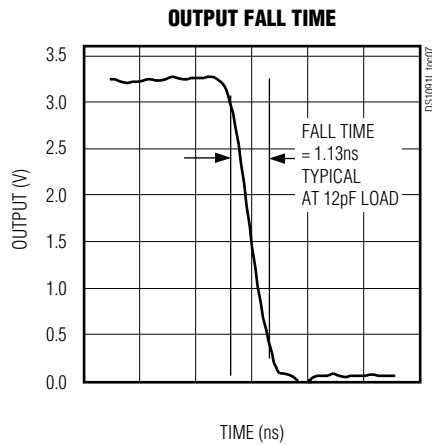
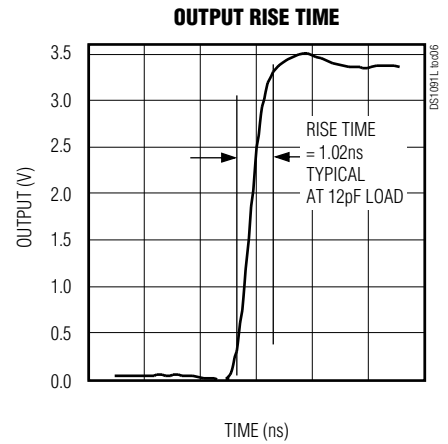
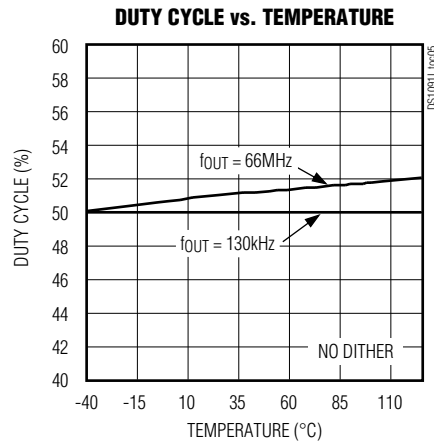
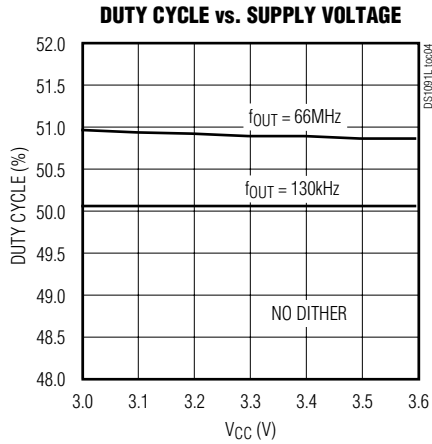

DS1091L

Automotive Temperature Range Spread-Spectrum EconOscillator™

Pin Configuration

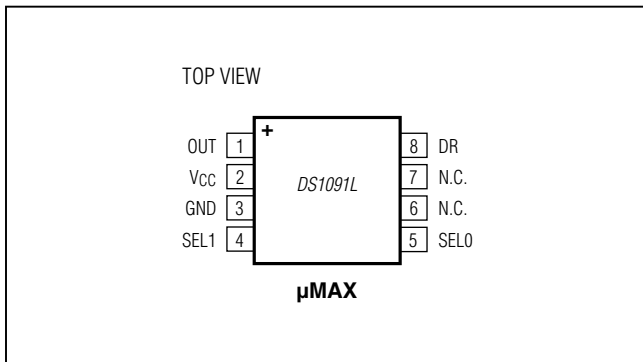

Pin Description

PIN	NAME	FUNCTION
1	OUT	Spread-Spectrum Clock Output
2	V _{CC}	Supply Voltage
3	GND	Ground
4	SEL1	Spread-Spectrum Dither Magnitude Select Inputs. Selects dither magnitude (see Table 1).
5	SEL0	
6, 7	N.C.	No Connection
8	DR	Spread-Spectrum Dither Rate Selector. Selects dither rate (see Table 2).

Block Diagram

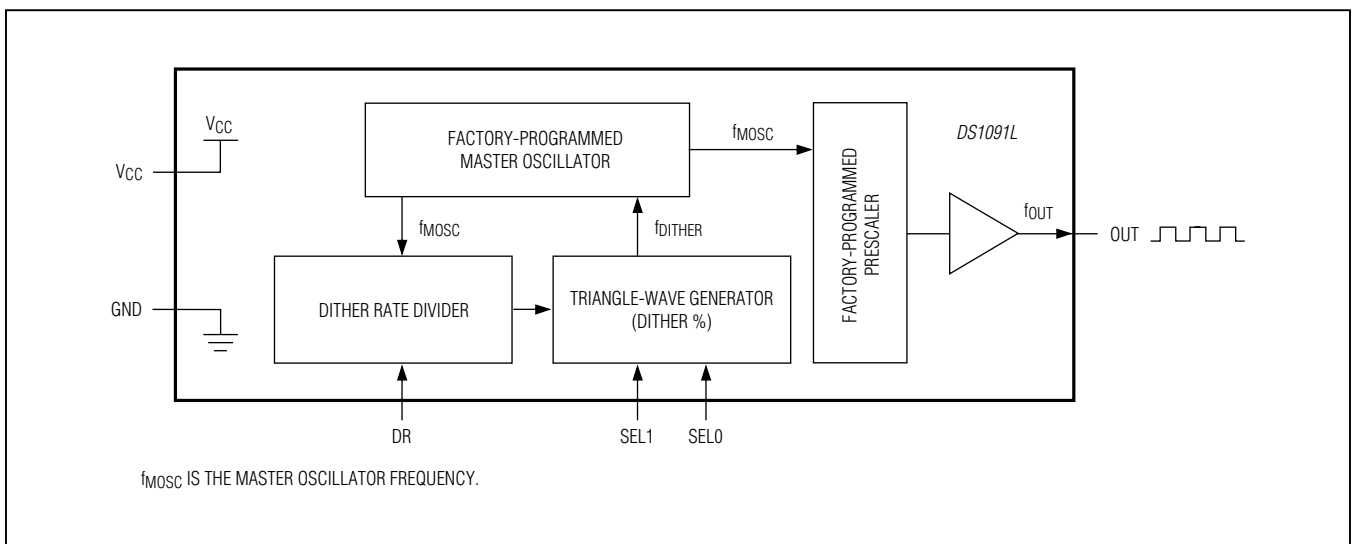

DS1091L

Automotive Temperature Range Spread-Spectrum EconOscillator™

Detailed Description

The DS1091L clock generator is capable of output frequencies from 130kHz to 66.6MHz over the full automotive temperature range (-40°C to +125°C). The device can also produce a spread-spectrum (dithered) square-wave output using four pin-selectable dither percentages. Both center (DS1091LUA) and down (DS1091LUB) dithering options are available. The device also features two selectable dither rates.

The DS1091L is shipped from the factory programmed to a customer-specified frequency.

Spread Spectrum

The DS1091L can reduce radiated emission peaks. The dither percentage is controlled by the state of the SEL0 and SEL1 pins. The output frequency can be dithered at 0%, ±1%, ±2%, and ±4%, centered around the programmed frequency (for the DS1091LUB this can be down dithered by 0%, -2%, -4%, and -8%).

The two select pins SEL0 and SEL1 provide a means of selecting the dither magnitudes as follows:

A triangle-wave generator injects a control signal into the master oscillator to dither its output. The dither rate is a function of the output frequency, f_{OUT} , as well as the setting of the DR pin (see the equation below). [Figure 1A](#) and [Figure 1B](#) show a plot of the output frequency vs. time.

$$\text{DITHER RATE} = \frac{f_{OUT}}{2^n}$$

where n is defined in [Table 2](#) as a function of output frequency. For example, for an output frequency of 27.0MHz, the dither rate would be 13.2kHz for DR = 1 and 6.6kHz for DR = 0.

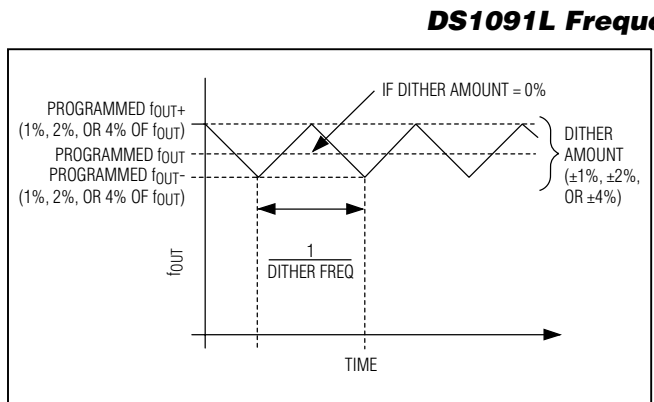

Figure 1A. Center Dithered

Power-Up

Upon the application of power, the DS1091L output is held in the low state until t_{PU} has elapsed. This removes any possibility of erroneous output transitions during initial power-up.

Table 1. Dither Magnitude

SEL1 LOGIC LEVEL	SEL0 LOGIC LEVEL	DITHER MAGNITUDE (%)	
		DS1091LUA	DS1091LUB
0	0	No dither	No dither
0	1	±1	-2
1	0	±2	-4
1	1	±4	-8

Table 2. Value of n w.r.t. Output Frequency

OUTPUT FREQUENCY f_{OUT} (MHz)		n	
f_{OUT} (min)	f_{OUT} (max)	DR = LOGIC LEVEL 1	DR = LOGIC LEVEL 0
0.130	0.260	4	5
0.261	0.521	5	6
0.522	1.042	6	7
1.043	2.083	7	8
2.084	4.167	8	9
4.168	8.333	9	10
8.334	16.667	10	11
16.668	33.333	11	12
33.334	66.667	12	13

DS1091L Frequency Spreading Profile as a Function of Dither %

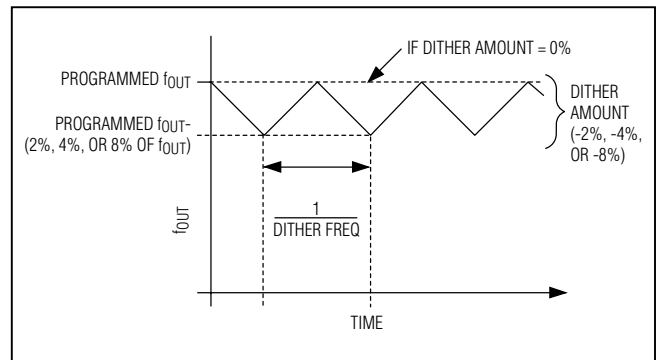

Figure 1B. Down Dithered

DS1091L

Automotive Temperature Range Spread-Spectrum EconOscillator™

Applications Information

Power-Supply Decoupling

To achieve best results, it is highly recommended that decoupling capacitors are used on the IC power-supply pins. Typical values of decoupling capacitors are 0.01 μ F and 0.1 μ F. Use a high-quality, ceramic, surface-mount capacitor, and mount it as close as possible to the V_{CC} and GND pins of the IC to minimize lead inductance.

Chip Information

SUBSTRATE CONNECTED TO GROUND

Package Information

For the latest package outline information and land patterns (footprints), go to www.maximintegrated.com/packages. Note that a "+", "#", or "-" in the package code indicates RoHS status only. Package drawings may show a different suffix character, but the drawing pertains to the package regardless of RoHS status.

PACKAGE TYPE	PACKAGE CODE	OUTLINE NO.	LAND PATTERN NO.
8 μ MAX	U8+1	21-0036	90-0092

Ordering Information

PART	TEMP RANGE	SPREAD SPECTRUM	OUTPUT FREQUENCY (MHz)	PIN-PACKAGE
DS1091LUA-027+	-40°C to +125°C	Center	27.0	8 μ MAX
DS1091LUA-027+T	-40°C to +125°C	Center	27.0	8 μ MAX
DS1091LUA-030/V+	-40°C to +125°C	Center	30.0	8 μ MAX
DS1091LUA-030/V+T	-40°C to +125°C	Center	30.0	8 μ MAX
DS1091LUA-033+	-40°C to +125°C	Center	33.3	8 μ MAX
DS1091LUA-033+T	-40°C to +125°C	Center	33.3	8 μ MAX
DS1091LUA-033/V+	-40°C to +125°C	Center	33.3	8 μ MAX
DS1091LUA-033/V+T	-40°C to +125°C	Center	33.3	8 μ MAX
DS1091LUA-040+	-40°C to +125°C	Center	40.0	8 μ MAX
DS1091LUA-040+T	-40°C to +125°C	Center	40.0	8 μ MAX
DS1091LUA-040/V+	-40°C to +125°C	Center	40.0	8 μ MAX
DS1091LUA-040/V+T	-40°C to +125°C	Center	40.0	8 μ MAX
DS1091LUA-055/V+	-40°C to +125°C	Center	55.4	8 μ MAX
DS1091LUA-055/V+T	-40°C to +125°C	Center	55.4	8 μ MAX
DS1091LUA-066+	-40°C to +125°C	Center	66.6	8 μ MAX
DS1091LUA-066+T	-40°C to +125°C	Center	66.6	8 μ MAX
DS1091LUA-066/V+	-40°C to +125°C	Center	66.6	8 μ MAX
DS1091LUA-066/V+T	-40°C to +125°C	Center	66.6	8 μ MAX
DS1091LUA-10A/V+	-40°C to +125°C	Center	10.38	8 μ MAX
DS1091LUA-10A/V+T	-40°C to +125°C	Center	10.38	8 μ MAX
DS1091LUA-172/V+	-40°C to +125°C	Center	1.7	8 μ MAX

V denotes an automotive qualified part.

+Denotes a lead(Pb)-free/RoHS-compliant package.

T = Tape and reel.

[Ordering Information](#) continued on next page.

DS1091L

Automotive Temperature Range Spread-Spectrum EconOscillator™

Ordering Information (continued)

PART	TEMP RANGE	SPREAD SPECTRUM	OUTPUT FREQUENCY (MHz)	PIN-PACKAGE
DS1091LUA-172/V+T	-40°C to +125°C	Center	1.7	8 µMAX
DS1091LUA-190/V+	-40°C to +125°C	Center	1.9	8 µMAX
DS1091LUA-190/V+T	-40°C to +125°C	Center	1.9	8 µMAX
DS1091LUA-200+	-40°C to +125°C	Center	0.20	8 µMAX
DS1091LUA-200+T	-40°C to +125°C	Center	0.20	8 µMAX
DS1091LUA-200/V+	-40°C to +125°C	Center	0.20	8 µMAX
DS1091LUA-200/V+T	-40°C to +125°C	Center	0.20	8 µMAX
DS1091LUA-330+	-40°C to +125°C	Center	33.0	8 µMAX
DS1091LUA-330+T	-40°C to +125°C	Center	33.0	8 µMAX
DS1091LUA-330/V+	-40°C to +125°C	Center	33.0	8 µMAX
DS1091LUA-330/V+T	-40°C to +125°C	Center	33.0	8 µMAX
DS1091LUA-xxx+	-40°C to +125°C	Center	Custom (contact factory)	8 µMAX
DS1091LUB-008+T	-40°C to +125°C	Down	8.0	8 µMAX
DS1091LUB-016/V+	-40°C to +125°C	Down	16.6	8 µMAX
DS1091LUB-016/V+T	-40°C to +125°C	Down	16.6	8 µMAX
DS1091LUB-019/V+	-40°C to +125°C	Down	19.9	8 µMAX
DS1091LUB-019/V+T	-40°C to +125°C	Down	19.9	8 µMAX
DS1091LUB-025/V+	-40°C to +125°C	Down	25.0	8 µMAX
DS1091LUB-025/V+T	-40°C to +125°C	Down	25.0	8 µMAX
DS1091LUB-027+	-40°C to +125°C	Down	27.0	8 µMAX
DS1091LUB-027+T	-40°C to +125°C	Down	27.0	8 µMAX
DS1091LUB-027/V+	-40°C to +125°C	Down	27.0	8 µMAX
DS1091LUB-027/V+T	-40°C to +125°C	Down	27.0	8 µMAX
DS1091LUB-033+	-40°C to +125°C	Down	33.3	8 µMAX
DS1091LUB-033+T	-40°C to +125°C	Down	33.3	8 µMAX
DS1091LUB-066+	-40°C to +125°C	Down	66.6	8 µMAX
DS1091LUB-066+T	-40°C to +125°C	Down	66.6	8 µMAX
DS1091LUB-xxx+	-40°C to +125°C	Down	Custom (contact factory)	8 µMAX

V denotes an automotive qualified part.

+ Denotes a lead(Pb)-free/RoHS-compliant package.

T = Tape and reel.

xxx Denotes factory-programmed custom frequencies. Email custom.oscillators@maximintegrated.com for more information.

DS1091L

Automotive Temperature Range Spread-Spectrum EconOscillator™

Revision History

REVISION NUMBER	REVISION DATE	DESCRIPTION	PAGES CHANGED
0	9/06	Initial release	—
1	3/11	Added the continuous power dissipation numbers, lead temperature, and soldering temperature to the <i>Absolute Maximum Ratings</i> section; updated the custom frequency technical support information; updated the <i>Ordering Information</i> table; added the land pattern no. to the <i>Package Information</i> table	1, 2, 7
2	9/11	Updated the <i>Ordering Information</i> table	7
3	6/13	Updated the <i>Ordering Information</i> table (adding rows)	7, 8



Maxim Integrated cannot assume responsibility for use of any circuitry other than circuitry entirely embodied in a Maxim Integrated product. No circuit patent licenses are implied. Maxim Integrated reserves the right to change the circuitry and specifications without notice at any time. The parametric values (min and max limits) shown in the Electrical Characteristics table are guaranteed. Other parametric values quoted in this data sheet are provided for guidance.

Maxim Integrated 160 Rio Robles, San Jose, CA 95134 USA 1-408-601-1000

9

X-ON Electronics

Largest Supplier of Electrical and Electronic Components

Click to view similar products for [Clock Generators & Support Products](#) category:

Click to view products by [Maxim](#) manufacturer:

Other Similar products are found below :

[CV183-2TPAG](#) [82P33814ANLG/W](#) [950810CGLF](#) [9DBV0741AKILF](#) [9VRS4420DKLF](#) [CY25404ZXI226](#) [CY25422SXI-004](#) [MPC9893AE](#)
[NB3H5150-01MNTXG](#) [PL602-20-K52TC](#) [PI6LC48P0101LIE](#) [82P33814ANLG](#) [840021AGLF](#) [ZL30244LFG7](#) [PI6LC48C21LE](#)
[ZL30245LFG7](#) [PI6LC48P0405LIE](#) [PI6LC48P03LE](#) [MAX24505EXG+](#) [ZL30163GDG2](#) [5L1503L-000NVTI8](#) [MAX24188ETK2](#)
[ZL30152GGG2](#) [5L1503-000NVTI8](#) [PI6C557-01BZHIEX](#) [PI6LC48C21LIE](#) [PI6C557-03AQEX](#) [5P35023-106NLGI](#) [5X1503L-000NLGI8](#)
[ZL30121GGG2V2](#) [ZL30282LDG1](#) [ZL30102QDG1](#) [ZL30159GGG2](#) [ZL30145GGG2](#) [ZL30312GKG2](#) [MAX24405EXG2](#) [ZL30237GGG2](#)
[SY100EL34LZG](#) [9FGV1002BQ506LTGI](#) [AD9518-4ABCPZ](#) [MX852BB0030](#) [PI6LC4840ZHE](#) [AD9516-0BCPZ-REEL7](#) [PL602-21TC-R](#)
[ZL30105QDG1](#) [ZL30100QDG1](#) [ZL30250LDG1](#) [DSC557-0334FI1](#) [DSC557-0343FI1](#) [AB-557-03-HCHC-F-L-C-T](#)