

DS1921H/DS1921Z High-Resolution Thermochron iButton Devices

SPECIAL FEATURES

- Digital thermometer measures temperature in 1/8°C increments with ±1°C accuracy
- Built-in real-time clock (RTC) and timer has accuracy of ±2 minutes per month from 0°C to +45°C
- Water resistant or waterproof if placed inside DS9107 iButton® capsule (Exceeds Water Resistant 3 ATM requirements)
- Automatically wakes up and measures temperature at user-programmable intervals from 1 to 255 minutes
- Logs consecutive temperature measurements in 2KB of datalog memory
- Records a long-term temperature histogram with 1/2°C resolution
- Programmable temperature-high and temperature-low alarm trip points
- Records up to 24 time stamps and durations when temperature leaves the range specified by the trip points
- 512 bytes of general-purpose battery-backed SRAM
- Communicates to host with a single digital signal at 15.4kbits or 125kbits per second using 1-Wire® protocol
- Fixed range: H: +15°C to +46°C;
Z: -5°C to +26°C

COMMON iButton DEVICE FEATURES

- Digital identification and information by momentary contact
- Unique, factory-lasered and tested 64-bit registration number (8-bit family code + 48-bit serial number + 8-bit CRC tester) assures absolute traceability because no two parts are alike
- Multidrop controller for 1-Wire net
- Chip-based data carrier compactly stores information
- Data can be accessed while affixed to object

- Button shape is self-aligning with cup-shaped probes
- Durable stainless steel case engraved with registration number withstands harsh environments
- Easily affixed with self-stick adhesive backing, latched by its flange, or locked with a ring pressed onto its rim
- Presence detector acknowledges when reader first applies voltage

PIN CONFIGURATION

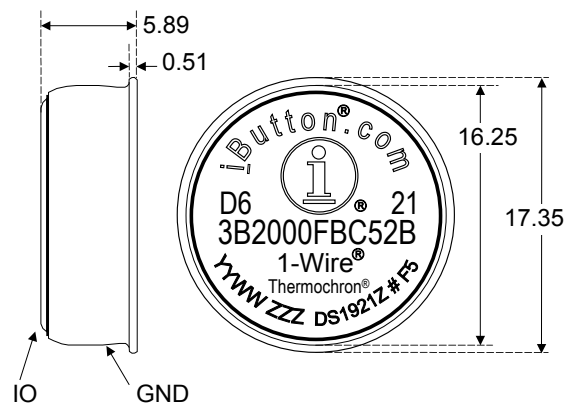

All dimensions are shown in millimeters.

ORDERING INFORMATION

| PART | TEMP RANGE | PIN-PACKAGE |
|-------------|----------------|-------------|
| DS1921H-F5# | +15°C to +46°C | F5 Can |
| DS1921Z-F5# | -5°C to +26°C | F5 Can |

#Denotes a RoHS-compliant device that may include lead(Pb) that is exempt under the RoHS requirements.

EXAMPLES OF ACCESSORIES

| | |
|----------|-------------------------|
| DS9096P | Self-Stick Adhesive Pad |
| DS9101 | Multi-Purpose Clip |
| DS9093RA | Mounting Lock Ring |
| DS9093A | Snap-In Fob |
| DS9092 | iButton Device Probe |

iButton DEVICE DESCRIPTION

The DS1921H/Z Thermochron® iButton devices are rugged, self-sufficient systems that measure temperature and record the result in a protected memory section. The recording is done at a user-defined rate, both as a direct storage of temperature values as well as in the form of a histogram. Up to 2048 temperature values taken at equidistant intervals ranging from 1 to 255 minutes can be stored. The histogram provides 64 data bins with a resolution of 0.5°C. If the temperature leaves a user-programmable range, the DS1921H/Z will also record when this happened, for how long the temperature stayed outside the permitted range, and if the temperature was too high or too low. Additional 512 bytes of general-purpose battery-backed SRAM allow storing information pertaining to the object to which the DS1921H/Z is associated. Data is transferred serially via the 1-Wire protocol, which requires only a single data lead and a ground return. Every DS1921H/Z is factory-lasered with a guaranteed unique electrically readable 64-bit registration number that allows for absolute traceability. The durable stainless steel package is highly resistant to environmental hazards such as dirt, moisture, and shock. Accessories permit the DS1921H/Z to be mounted on almost any object, including containers, pallets, and bags.

APPLICATION

The DS1921Z is an ideal device to monitor the temperature of any object it is attached to or shipped with, such as fresh produce, medical drugs and supplies. It is also ideal for use in refrigerators. The DS1921H is intended for monitoring the body temperature of humans and animals and for monitoring temperature critical processes such as curing, powder coating, and painting. Alternatively, the DS1921H can be used for monitoring the temperature of clean rooms, and computer and equipment rooms. It can also aid in calculating the proportional share of heating cost of each party in buildings with central heating. The DS1921H has a fixed range of +15°C to +46°C. The DS1921Z has a fixed range of -5°C to +26°C. The high resolution makes the DS1921H and DS1921Z suitable for scientific research and development. The general-purpose battery-backed SRAM can store information such as shipping manifests, dates of manufacture, or other relevant data written as ASCII or encrypted files. Note that the initial sealing level of DS1921H/Z achieves the equivalent of IP56. Aging and use conditions can degrade the integrity of the seal over time, so for applications with significant exposure to liquids, sprays, or other similar environments, it is recommended to place the Thermochron in the DS9107 iButton capsule. The DS9107 provides a watertight enclosure that has been rated to IP68 (refer to Application Note 4126).

OVERVIEW

The block diagram in Figure 1 shows the relationships between the major control and memory sections of the DS1921H/Z. The device has seven main data components: 1) 64-bit lasered ROM; 2) 256-bit scratchpad; 3) 4096-bit general-purpose SRAM; 4) 256-bit register page of timekeeping, control, and counter registers; 5) 96 bytes of alarm time stamp and duration logging memory; 6) 128 bytes of histogram memory; and 7) 2048 bytes of datalog memory. Except for the ROM and the scratchpad, all other memory is arranged in a single linear address space. All memory reserved for logging purposes, counter registers and several other registers are read-only for the user. The timekeeping and control registers are write-protected while the device is programmed for a mission.

The hierarchical structure of the 1-Wire protocol is shown in Figure 2. The bus master must first provide one of the seven ROM function commands: 1) Read ROM; 2) Match ROM; 3) Search ROM; 4) Conditional Search ROM; 5) Skip ROM; 6) Overdrive-Skip ROM; or 7) Overdrive-Match ROM. Upon completion of an Overdrive ROM command byte executed at standard speed, the device will enter Overdrive mode, where all subsequent communication occurs at a higher speed. The protocol required for these ROM function commands is described in Figure 13. After a ROM function command is successfully executed, the memory functions become accessible and the master may provide any one of the seven available commands. The protocol for these memory function commands is described in Figure 10. **All data is read and written least significant bit first.**

DS1921H/Z BLOCK DIAGRAM Figure 1

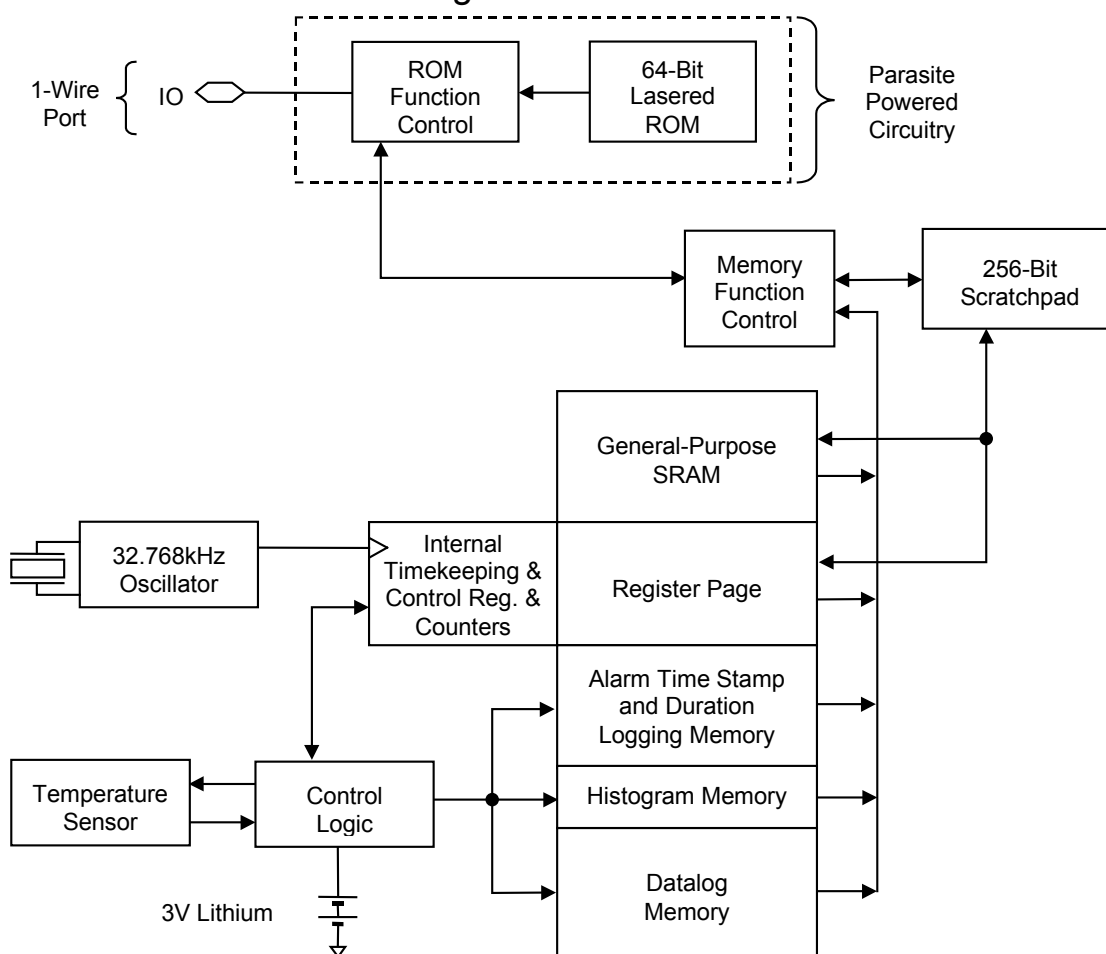

PARASITE POWER

The block diagram (Figure 1) shows the parasite-powered circuitry. This circuitry “steals” power whenever the IO input is high. IO will provide sufficient power as long as the specified timing and voltage requirements are met. The advantages of parasite power are two-fold: 1) By parasiting off this input, battery power is not consumed for 1-Wire ROM function commands, and 2) if the battery is exhausted for any reason, the ROM may still be read normally. The remaining circuitry of the DS1921 is solely operated by battery energy. As a consequence, if the battery is exhausted, all memory data is lost including the data of the last mission, and no new mission can be started. Application Note 5057: *OneWireViewer Tips and Tricks* explains how to check the battery status.

64-BIT LASERED ROM

Each DS1921 contains a unique ROM code that is 64 bits long. The first eight bits are a 1-Wire family code. The next 36 bits are a unique serial number. The next 12 bits, called temperature range code, allow distinguishing the DS1921H and DS1921Z from each other and from other DS1921 versions. The last eight bits are a CRC of the first 56 bits. See Figure 3 for details. The 1-Wire CRC is generated using a polynomial generator consisting of a shift register and XOR gates as shown in Figure 4. The polynomial is $X^8 + X^5 + X^4 + 1$. Additional information about the Maxim 1-Wire Cyclic Redundancy Check is available in Application Note 27.

The shift register bits are initialized to 0. Then starting with the least significant bit of the family code, one bit at a time is shifted in. After the eighth bit of the family code has been entered, then the serial number followed by the temperature range code is entered. After the range code has been entered, the shift register contains the CRC value. Shifting in the eight bits of CRC returns the shift register to all 0s.

HIERARCHICAL STRUCTURE FOR 1-Wire PROTOCOL Figure 2

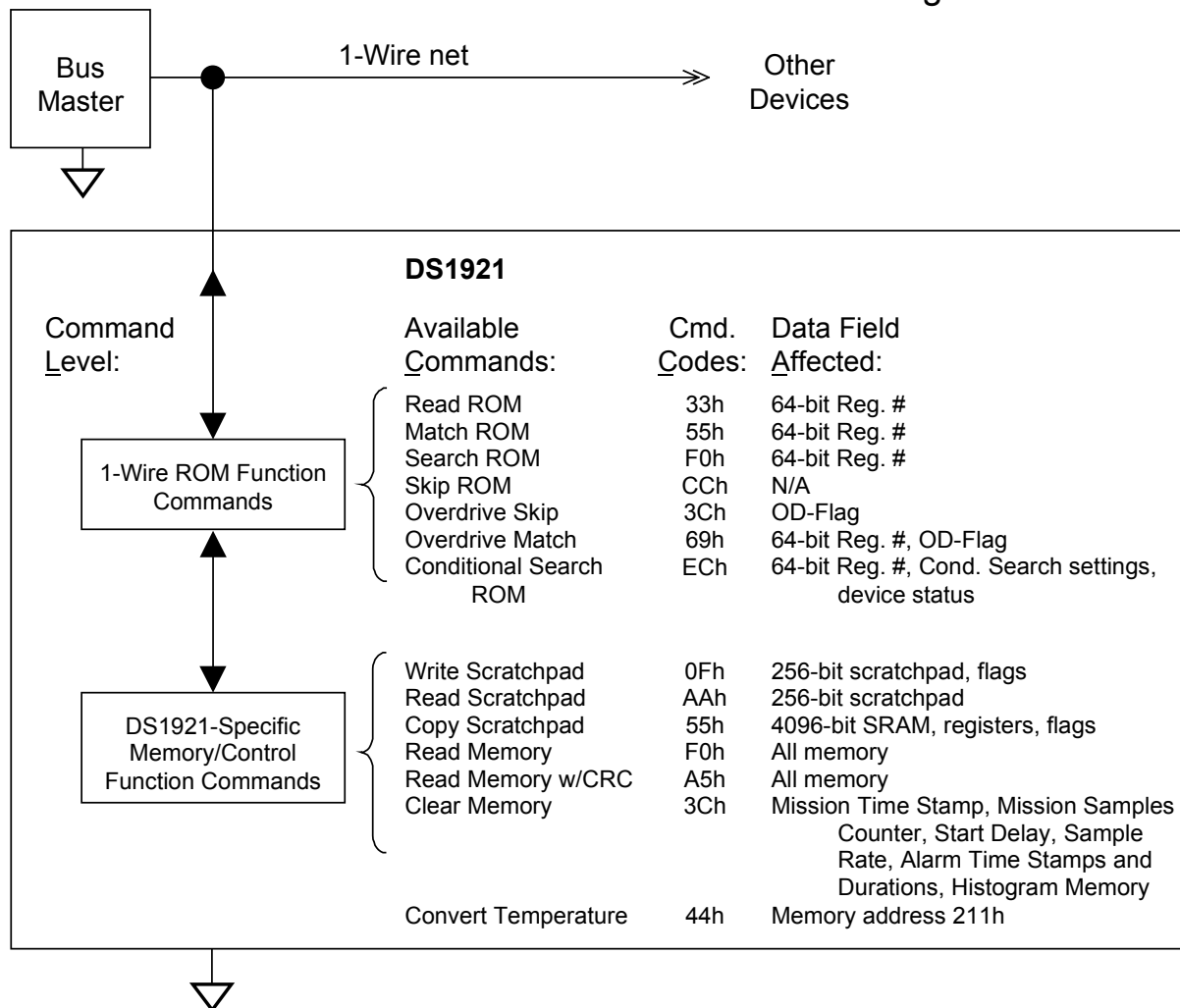

64-BIT LASERED ROM Figure 3

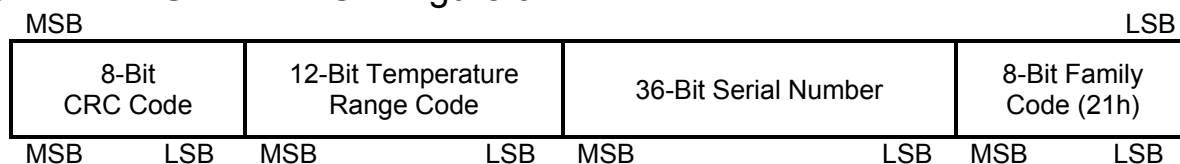

| DEVICE | TEMP. RANGE (°C) | RESOLUTION (°C) | TEMP. RANGE CODE | | | HEX. EQUIVALENT |
|------------|------------------|-----------------|------------------|------|------|-----------------|
| DS1921H-F5 | +15 to +46 | 0.125 | 0100 | 1111 | 0010 | 4F2 |
| DS1921Z-F5 | -5 to +26 | 0.125 | 0011 | 1011 | 0010 | 3B2 |

1-Wire CRC GENERATOR Figure 4

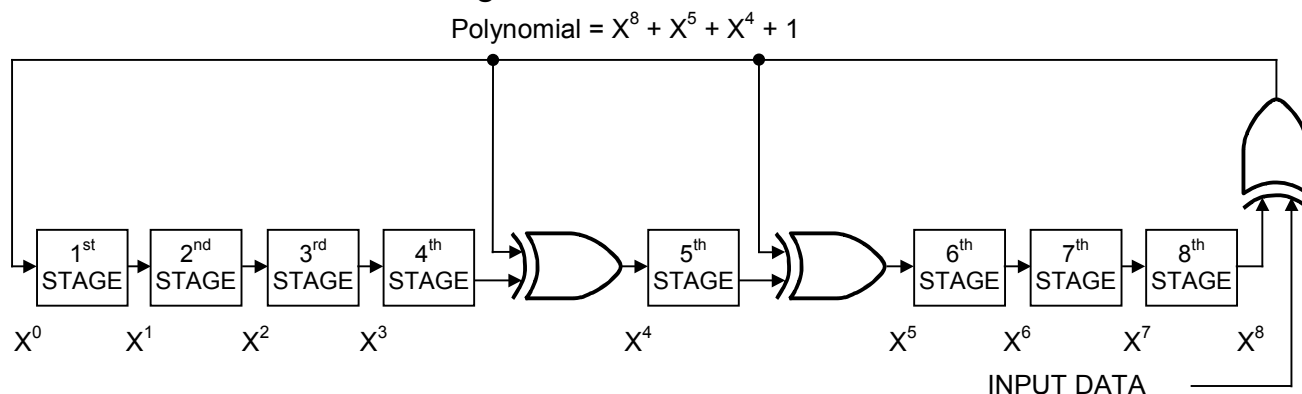

MEMORY

The memory map of the DS1921H/Z is shown in Figure 5. The 4096-bit general-purpose SRAM make up pages 0 through 15. The timekeeping, control, and counter registers fill page 16, called Register Page (see Figure 6). Pages 17 to 19 are assigned to storing the alarm time stamps and durations. The temperature histogram bins begin at page 64 and use up to four pages. The datalog memory covers pages 128 to 191. Memory pages 20 to 63, 68 to 127, and 192 to 255 are reserved for future extensions. The scratchpad is an additional page that acts as a buffer when writing to the SRAM or the register page. The memory pages 17 and higher are read-only for the user. They are written to or erased solely under supervision of the on-chip control logic.

DS1921H/Z MEMORY MAP Figure 5

| 32-Byte Intermediate Storage Scratchpad | | |
|---|--|------------------|
| ADDRESS | | |
| 0000h to 01FFh | General-Purpose SRAM (16 Pages) | Pages 0 to 15 |
| 0200h to 021Fh | 32-Byte Register Page | Page 16 |
| 0220h to 027Fh | Alarm Time Stamps and Durations | Pages 17 to 19 |
| 0280h to 07FFh | (Reserved for Future Extensions) | Pages 20 to 63 |
| 0800h to 087Fh | Temperature Histogram Memory | Pages 64 to 67 |
| 0880h to 0FFFh | (Reserved for Future Extensions) | Pages 68 to 127 |
| 1000h to 17FFh | Datalog Memory (64 Pages) | Pages 128 to 191 |
| 1800h to 1FFFh | (Reserved for Future Extensions) | Pages 192 to 255 |

DS1921H/Z REGISTER PAGE MAP Figure 6

| ADDR | b7 | b6 | b5 | b4 | b3 | b2 | b1 | b0 | Function | Access* |
|-------|---|------------------|---------------|--------------|----------------------|-------------------|-----|-----|---------------------------------|------------|
| 0200h | 0 | 10 Seconds | | | Single Seconds | | | | Real-Time Clock Registers | R/W; R/W** |
| 0201h | 0 | 10 Minutes | | | Single Minutes | | | | | |
| 0202h | 0 | 12/24 | 20h. AM/PM | 10h. | Single Hours | | | | | |
| 0203h | 0 | 0 | 0 | 0 | 0 | Day of Week | | | | |
| 0204h | 0 | 0 | 10 Date | | Single Date | | | | | |
| 0205h | CENT | 0 | 0 | 10m. | Single Months | | | | | |
| 0206h | 10 Years | | | Single Years | | | | | | |
| 0207h | MS | 10 Seconds Alarm | | | Single Seconds Alarm | | | | Real-Time Clock Alarm Registers | R/W; R/W** |
| 0208h | MM | 10 Minutes Alarm | | | Single Minutes Alarm | | | | | |
| 0209h | MH | 12/24 | 10ha. A/P | 10h. alm. | Single Hours Alarm | | | | | |
| 020Ah | MD | 0 | 0 | 0 | 0 | Day of Week Alarm | | | | |
| 020Bh | Temperature Low Alarm Threshold | | | | | | | | Temp. Alarms | R/W; R/W** |
| 020Ch | Temperature High Alarm Threshold | | | | | | | | | |
| 020Dh | Number of Minutes Between Temperature Conversions | | | | | | | | Sample Rate | R/W; R** |
| 020Eh | <u>EO</u> SC | EMCLR | 0 | <u>EM</u> | RO | TLS | THS | TAS | Control | R/W; R/W** |
| 020Fh | (no function, reads 00h) | | | | | | | | (N/A) | R; R** |
| 0210h | (no function, reads 00h) | | | | | | | | (N/A) | R; R** |
| 0211h | Temperature Read Out (Forced Conversion) | | | | | | | | Temp. | R; R** |
| 0212h | Low Byte | | | | | | | | Start Delay | R/W; R/W** |
| 0213h | High Byte | | | | | | | | | |
| 0214h | <u>TC</u> B | MEMCLR | MIP | SIP | 0 | TLF | THF | TAF | Status | R/W; R/W |
| 0215h | Minutes | | | | | | | | Mission Time Stamp | R; R |
| 0216h | Hours | | | | | | | | | |
| 0217h | Date | | | | | | | | | |
| 0218h | Month | | | | | | | | | |
| 0219h | Year | | | | | | | | | |
| 021Ah | Low Byte | | | | | | | | Mission Samples Counter | R; R |
| 021Bh | Center Byte | | | | | | | | | |
| 021Ch | High Byte | | | | | | | | | |
| 021Dh | Low Byte | | | | | | | | Device Samples Counter | R; R |
| 021Eh | Center Byte | | | | | | | | | |
| 021Fh | High Byte | | | | | | | | | |

*The first entry in column ACCESS is valid between missions. The second entry shows the applicable access mode while a mission is in progress.

**While a mission is in progress, these addresses can be read. The first attempt to write to these registers (even read-only ones), however, will end the mission and overwrite selected writeable registers.

TIMEKEEPING

The RTC/alarm and calendar information is accessed by reading/writing the appropriate bytes in the register page, address 200h to 206h. Note that some bits are set to 0. These bits will always read 0 regardless of how they are written. The contents of the time, calendar, and alarm registers are in the Binary-Coded Decimal (BCD) format.

RTC and RTC Alarm Register Bitmap

| ADDR | b7 | b6 | b5 | b4 | b3 | b2 | b1 | b0 |
|-------|----------|------------------|---------------|--------------|----------------------|-------------------|----|----|
| 0200h | 0 | 10 Seconds | | | Single Seconds | | | |
| 0201h | 0 | 10 Minutes | | | Single Minutes | | | |
| 0202h | 0 | 12/24 | 20h. AM/PM | 10h. | Single Hours | | | |
| 0203h | 0 | 0 | 0 | 0 | 0 | Day of Week | | |
| 0204h | 0 | 0 | 10 Date | | Single Date | | | |
| 0205h | CENT | 0 | 0 | 10m. | Single Months | | | |
| 0206h | 10 Years | | | | Single Years | | | |
| 0207h | MS | 10 Seconds Alarm | | | Single Seconds Alarm | | | |
| 0208h | MM | 10 Minutes Alarm | | | Single Minutes Alarm | | | |
| 0209h | MH | 12/24 | 10ha. A/P | 10h. alm. | Single Hours Alarm | | | |
| 020Ah | MD | 0 | 0 | 0 | 0 | Day of Week Alarm | | |

RTC/Calendar

The RTC of the DS1921H/Z can run in either 12-hour or 24-hour mode. Bit 6 of the Hours Register (address 202h) is defined as the 12- or 24-hour mode select bit. When high, the 12-hour mode is selected. In the 12-hour mode, bit 5 is the AM/PM bit with logic 1 being PM. In the 24-hour mode, bit 5 is the 20-hour bit (20 to 23 hours).

To distinguish between the days of the week the DS1921H/Z includes a counter with a range from 1 to 7. The assignment of counter value to the day of week is arbitrary. Typically, the number 1 is assigned to a Sunday (U.S. standard) or to a Monday (European standard).

The calendar logic is designed to automatically compensate for leap years. For every year value that is either 00 or a multiple of 4 the device will add a 29th of February. This will work correctly up to (but not including) the year 2100.

The DS1921H/Z is Y2K-compliant. Bit 7 (CENT) of the Months Register at address 205h serves as a century flag. When the Year Register rolls over from 99 to 00 the century flag will toggle. It is recommended to write the century bit to a 1 when setting the RTC to a time/date between the years 2000 and 2099.

RTC Alarms

The DS1921H/Z also contains a RTC alarm function. The alarm registers are located in registers 207h to 20Ah. The most significant bit of each of the alarm registers is a mask bit. When all of the mask bits are logic 0, an alarm will occur once per week when the values stored in timekeeping registers 200h to 203h match the values stored in the time of day alarm registers. Any alarm will set the Timer Alarm Flag (TAF) in the device's Status Register (address 214h). The bus master may set the Search Conditions in the Control Register (address 20Eh) to identify devices with timer alarms by means of the Conditional Search function (see *ROM Function Commands*).

RTC Alarm Control

| ALARM REGISTER MASK BITS (Bit 7 of 207h to 20Ah) | | | | |
|---|----|----|----|--|
| MS | MM | MH | MD | |
| 1 | 1 | 1 | 1 | Alarm once per second. |
| 0 | 1 | 1 | 1 | Alarm when seconds match (once per minute). |
| 0 | 0 | 1 | 1 | Alarm when minutes and seconds match (once every hour). |
| 0 | 0 | 0 | 1 | Alarm when hours, minutes and seconds match (once every day). |
| 0 | 0 | 0 | 0 | Alarm when day, hours, minutes, and seconds match (once every week). |

TEMPERATURE CONVERSION

The DS1921H and DS1921Z measure temperatures with a resolution of 1/8th of a degree Celsius. Temperature values are represented in a single byte as an unsigned binary number, which translates into a range of 32°C. The possible values are 0000 0000 (00h) through 1111 1111 (FFh). The codes 01h to FEh are considered valid temperature readings. Since the DS1921H and DS1921Z have different starting temperatures, the meaning of a binary temperature code depends on the device.

If a temperature conversion yields a temperature that is out-of-range, it will be recorded as 00h (if too low) or FFh (if too high). Since out-of-range results are accumulated in histogram bins 0 and 63 the data in these bins is of limited value (see the *Temperature Logging and Histogram* section). For this reason the specified temperature range of the DS1921H and DS1921Z is considered to begin at code 04h and end at code FBh, which corresponds to histogram bins 1 to 62.

With T[7..0] representing the decimal equivalent of a temperature reading, the temperature value is calculated as

$$\vartheta (\text{°C}) = T[7...0] / 8 + 14.500 \text{ (DS1921H)}$$

$$\vartheta (\text{°C}) = T[7...0] / 8 - 5.500 \text{ (DS1921Z)}$$

This equation is valid for converting temperature readings stored in the datalog memory as well as for data read from the forced temperature conversion readout Register (address 211h).

To specify the high or low temperature alarm thresholds, this equation needs to be resolved to

$$T[7...0] = 8 * \vartheta (\text{°C}) - 116 \text{ (DS1921H)}$$

$$T[7...0] = 8 * \vartheta (\text{°C}) + 44 \text{ (DS1921Z)}$$

A value of 23°C, for example, thus translates into 68 decimal or 44h for the DS1921H, and 228 decimal or E4h for the DS1921Z. This corresponds to the binary patterns 0100 0100 and 1110 0100 respectively, which could be written to a Temperature Alarm Register (address 020Bh and 020Ch, respectively).

Temperature Alarm Register Map

| ADDR | b7 | b6 | b5 | b4 | b3 | b2 | b1 | b0 |
|-------|----------------------------------|----|----|----|----|----|----|----|
| 020Bh | Temperature Low Alarm Threshold | | | | | | | |
| 020Ch | Temperature High Alarm Threshold | | | | | | | |

SAMPLE RATE

The content of the Sample Rate Register (address 020Dh) determines how many minutes the temperature conversions are apart from each other during a mission. The sample rate may be any value from 1 to 255, coded as an unsigned 8-bit binary number. If the memory has been cleared (Status Register bit MEMCLR = 1) and a mission is enabled (Status Register bit \overline{EM} = 0), writing a non-zero value to the Sample Rate Register will start a mission. For a full description of the correct sequence of steps to start a temperature-logging mission see sections *Missioning* or *Missioning Example*.

Sample Rate Register Map

| | | | | | | | | |
|-------|-------------|----|----|----|----|----|----|----|
| ADDR | b7 | b6 | b5 | b4 | b3 | b2 | b1 | b0 |
| 020Dh | Sample Rate | | | | | | | |

CONTROL REGISTER

The DS1921H/Z is set up for its operation by writing appropriate data to its special function registers that are located in the register page. Several functions that are controlled by a single bit only are combined into a single byte called Control Register (address 20Eh). This register can be read and written. If the device is programmed for a mission, writing to the Control Register will **end the mission** and change the register contents.

Control Register Bitmap

| | | | | | | | | |
|-------|-------------------|-------|----|-----------------|----|-----|-----|-----|
| ADDR | b7 | b6 | b5 | b4 | b3 | b2 | b1 | b0 |
| 020Eh | \overline{EOSC} | EMCLR | 0 | \overline{EM} | RO | TLS | THS | TAS |

The functional assignments of the individual bits are explained in the table below. Bit 5 has no function. It always reads 0 and cannot be written to 1.

Control Register Details

| BIT DESCRIPTION | BIT(S) | DEFINITION |
|---------------------------------------|--------|---|
| \overline{EOSC} : Enable Oscillator | b7 | This bit controls the crystal oscillator of the RTC. When set to logic 0, the oscillator will start operation. When written to logic 1, the oscillator will stop and the device is in a low-power data retention mode. This bit must be 0 for normal operation. The RTC must have advanced at least 1 second before a mission start will be accepted. |
| EMCLR: Memory Clear Enable | b6 | This bit needs to be set to logic 1 to enable the Clear Memory function, which is invoked as a memory function command. The Time-Stamp, Histogram Memory as well as the Mission Time Stamp, Mission Samples Counter, Mission Start Delay and Sample Rate will be cleared only if the Clear Memory command is issued with the next access to the device . The EMCLR bit will return to 0 as the next memory function command is executed. |
| \overline{EM} : Enable Mission | b4 | This bit controls whether the DS1921H/Z will begin a mission as soon as the sample rate is written. To enable the device for a mission, this bit must be 0. |
| RO: Rollover Enable/Disable | b3 | This bit controls whether the datalog memory is overwritten with new data or whether data logging is stopped once the memory is filled with data during a mission. Setting this bit to a 1 enables the rollover and data logging continues at the beginning overwriting previously collected data. Clearing this bit to 0 disables the rollover and no further temperature values will be stored in the datalog memory once it is filled with data. This will not stop the mission. The device will continue measuring temperatures and updating the histogram and alarm time stamps and durations. |

| BIT DESCRIPTION | BIT(S) | DEFINITION |
|------------------------------------|--------|--|
| TLS: Temperature Low Alarm Search | b2 | If this bit is 1, the device will respond to a Conditional Search command if during a mission the temperature has reached or is lower than the Low Temperature Threshold stored at address 020Bh. |
| THS: Temperature High Alarm Search | b1 | If this bit is 1, the device will respond to a Conditional Search command if during a mission the temperature has reached or is higher than the High Temperature Threshold stored at address 020Ch. |
| TAS: Timer Alarm Search | b0 | If this bit is 1, the device will respond to a Conditional Search command if during a mission a timer alarm has occurred. Since a timer alarm cannot be disabled, the TAF flag usually reads 1 during a mission. Therefore it may be advisable to set the TAS bit to a 0, in most cases. |

Mission Start Delay Counter

The content of the Mission Start Delay Counter determines how many minutes the device will wait before starting the logging process. The mission start delay value is stored as unsigned 16-bit integer number at addresses 212h (low byte) and 213h (high byte). The maximum delay is 65535 minutes, equivalent to 45 days, 12 hours, and 15 minutes.

For a typical mission, the Mission Start Delay is 0. If a mission is too long for a single DS1921H/Z to store all temperature readings at the selected sample rate, one can use several devices, staggering the Mission Start Delay to record the full period. In this case, the RO bit in the control register (address 020Eh) must be set to 0 to prevent overwriting of the recorded temperature log after the datalog memory is full. See *Mission Start and Logging Process* description and flow chart for details.

Status Register

The Status Register holds device status information and alarm flags. The register is located at address 214h. Writing to this register will not necessarily end a mission.

Status Register Bitmap

| ADDR | b7 | b6 | b5 | b4 | b3 | b2 | b1 | b0 |
|-------|-----|--------|-----|-----|----|-----|-----|-----|
| 0214h | TCB | MEMCLR | MIP | SIP | 0 | TLF | THF | TAF |

The functional assignments of the individual bits are explained in the table below. The bits MIP, TLF, THF and TAF can only be written to 0. All other bits are read-only. Bit 3 has no function.

Status Register Details

| BIT DESCRIPTION | BIT(S) | DEFINITION |
|----------------------------|--------|---|
| TCB: Temperature Core Busy | b7 | If this bit reads 0 the DS1921H/Z is currently performing a temperature conversion, either self-initiated because of a mission being in <u>progress</u> or initiated by a command when a mission is not in progress. The TCB bit goes low just before a conversion starts and returns to high just after the result is latched into the readout register at address 0211h. |
| MEMCLR: Memory Cleared | b6 | If this bit reads 1, the memory pages 17 and higher (alarm time stamps/durations, temperature histogram, excluding datalog memory), as well as the Mission Time Stamp, Mission Samples Counter, Mission Start Delay and Sample Rate have been cleared to 0 from executing a Clear Memory function command. The MEMCLR bit will return to 0 as soon as writing a non-0 <u>value</u> to the Sample Rate Register starts a new mission, provided that the EM bit is also 0. The memory has to be cleared in order for a mission to start. |

| BIT DESCRIPTION | BIT(S) | DEFINITION |
|----------------------------|--------|--|
| MIP: Mission in Progress | b5 | If this bit reads 1 the DS1921H/Z has been set up for a mission and this mission is still in progress. A mission is started if the EM bit of the Control Register (address 20Eh) is 0 and a non-zero value is written to the Sample Rate Register, address 20Dh. The MIP bit returns from logic 1 to logic 0 when a mission is ended. A mission will end with the first write attempt (Copy Scratchpad command) to any register in the address range of 200h to 213h. Alternatively, a mission can be ended by directly writing to the Status Register and setting the MIP bit to 0. The MIP bit cannot be set to 1 by writing to the status register. |
| SIP: Sample in Progress | b4 | If this bit reads 1 the DS1921H/Z is currently performing a temperature conversion as part of a mission in progress. The mission samples occur on the seconds rollover from 59 to 00. The SIP bit will change from 0 to 1 approximately 250ms before the actual temperature conversion begins allowing the circuitry of the chip to wake-up. A temperature conversion including a wake-up phase takes maximum 875ms. During this time read accesses to the memory pages 17 and higher are permissible but may reveal invalid data. |
| TLF: Temperature Low Flag | b2 | Logic 1 in the Temperature Low Flag bit indicates that a temperature measurement during a mission revealed a temperature equal to or lower than the value in the Temperature Low Threshold Register. The Temperature Low Flag can be cleared at any time by writing this bit to 0. This flag must be cleared before starting a new mission. |
| THF: Temperature High Flag | b1 | Logic 1 in the Temperature High Flag bit indicates that a temperature measurement during a mission revealed a temperature equal to or higher than the value in the Temperature High Threshold Register. The Temperature High Flag can be cleared at any time by writing this bit to 0. This flag must be cleared before starting a new mission. |
| TAF: Timer Alarm Flag | b0 | If this bit reads 1, a RTC alarm has occurred (see section <i>TIMEKEEPING</i> for details). The Timer Alarm Flag can be cleared at any time by writing this bit to logic 0. Since the timer alarm cannot be disabled, the TAF flag usually reads 1 during a mission. This flag should be cleared before starting a new mission. |

MISSION TIME STAMP

The Mission Time Stamp indicates the time and date of the first temperature conversion of a mission. Subsequent temperature conversions will take place as many minutes apart from each other as specified by the value in the Sample Rate Register. Mission samples occur on minute boundaries.

Mission Time Stamp Register Bitmap

| ADDR | b7 | b6 | b5 | b4 | b3 | b2 | b1 | b0 |
|-------|----------|------------|---------------|------|----------------|----|----|----|
| 0215h | 0 | 10 Minutes | | | Single Minutes | | | |
| 0216h | 0 | 12/24 | 20h. AM/PM | 10h. | Single Hours | | | |
| 0217h | 0 | 0 | 10 Date | | Single Date | | | |
| 0218h | 0 | 0 | 0 | 10m. | Single Months | | | |
| 0219h | 10 Years | | | | Single Years | | | |

MISSION SAMPLES COUNTER

The Mission Samples Counter indicates how many temperature measurements have taken place during the current mission in progress (if MIP = 1) or during the latest mission (if MIP = 0). The value is stored as an unsigned 24-bit integer number. This counter is reset through the Clear Memory command.

Mission Samples Counter Register Map

| ADDR | b7 | b6 | b5 | b4 | b3 | b2 | b1 | b0 |
|-------|-------------|----|----|----|----|----|----|----|
| 021Ah | Low Byte | | | | | | | |
| 021Bh | Center Byte | | | | | | | |
| 021Ch | High Byte | | | | | | | |

DEVICE SAMPLES COUNTER

The Device Samples Counter indicates how many temperature measurements have taken place since the device was assembled at the factory. The value is stored as an unsigned 24-bit integer number. The maximum number that can be represented in this format is 16777215, which is higher than the expected lifetime of the DS1921H/Z devices. This counter cannot be reset under software control.

Device Samples Counter Register Map

| ADDR | b7 | b6 | b5 | b4 | b3 | b2 | b1 | b0 |
|-------|-------------|----|----|----|----|----|----|----|
| 021Dh | Low Byte | | | | | | | |
| 021Eh | Center Byte | | | | | | | |
| 021Fh | High Byte | | | | | | | |

TEMPERATURE LOGGING AND HISTOGRAM

Once setup for a mission, the DS1921H/Z logs the temperature measurements simultaneously byte after byte in the datalog memory as well as in histogram form in the histogram memory. The datalog memory is able to store 2048 temperature values measured at equidistant time points. The first temperature value of a mission is written to address location 1000h of the datalog memory, the second value to address location 1001h and so on. Knowing the starting time point (Mission Time Stamp), the interval between temperature measurements, the Mission Samples Counter, and the rollover setting, one can reconstruct the time and date of each measurement stored in the datalog.

There are two alternatives to the way the DS1921H/Z will behave after the 2048 bytes of datalog memory is filled with data. With rollover disabled (RO = 0), the device will fill the datalog memory with the first 2048 mission samples. Additional mission samples are not logged in the datalog, but the histogram, and temperature alarm memory continue to update. With rollover enabled (RO = 1), the datalog will wrap around, and overwrite previous data starting at 1000h for the every 2049th mission sample. In this mode the device stores the last 2048 mission samples.

For the temperature histogram, the DS1921H/Z provides 64 bins that begin at memory address 0800h. Each bin consists of a 16-bit, non-rolling-over binary counter that is incremented each time a temperature value acquired during a mission falls into the range of the bin. The least significant byte of each bin is stored at the lower address. Bin 0 begins at memory address 0800h, bin 1 at 0802h, and so on up to 087Eh for bin 63, as shown in Figure 7. The number of the bin to be updated after a temperature conversion is determined by cutting off the two least significant bits of the binary temperature value. Out of range values are range locked and counted as 00h or FFh.

HISTOGRAM BIN AND TEMPERATURE CROSS-REFERENCE Figure 7

| TEMPERATURE READING | DS1921H TEMP. EQUIV. IN °C | DS1921Z TEMP. EQUIV. IN °C | HISTOGRAM BIN NUMBER | HISTOGRAM BIN ADDRESS |
|---------------------|----------------------------|----------------------------|----------------------|-----------------------|
| 00h | 14.500 | -5.500 | 0 | 800h to 801h |
| 01h | 14.625 | -5.375 | 0 | 800h to 801h |
| 02h | 14.750 | -5.250 | 0 | 800h to 801h |
| 03h | 14.875 | -5.125 | 0 | 800h to 801h |
| 04h | 15.000 | -5.000 | 1 | 802h to 803h |
| 05h | 15.125 | -4.875 | 1 | 802h to 803h |
| 06h | 15.250 | -4.750 | 1 | 802h to 803h |
| 07h | 15.375 | -4.625 | 1 | 802h to 803h |
| 08h | 15.500 | -4.500 | 2 | 804h to 805h |
| | | | | |
| F7h | 45.375 | 25.375 | 61 | 87Ah to 87Bh |
| F8h | 45.500 | 25.500 | 62 | 87Ch to 87Dh |
| F9h | 45.625 | 25.625 | 62 | 87Ch to 87Dh |
| FAh | 45.750 | 25.750 | 62 | 87Ch to 87Dh |
| FBh | 45.875 | 25.875 | 62 | 87Ch to 87Dh |
| FCh | 46.000 | 26.000 | 63 | 87Eh to 87Fh |
| FDh | 46.125 | 26.125 | 63 | 87Eh to 87Fh |
| FEh | 46.250 | 26.250 | 63 | 87Eh to 87Fh |
| FFh | 46.375 | 26.375 | 63 | 87Eh to 87Fh |

Since each data bin is 2 bytes it can increment up to 65535 times. Additional measurements for a bin that has already reached its maximum value will not be counted; the bin counter will remain at its maximum value. With the fastest sample rate of one sample every minute, a 2-byte bin is sufficient for up to 45 days if all temperature readings fall into the same bin.

TEMPERATURE ALARM LOGGING

For some applications it may be essential to not only record temperature over time and the temperature histogram, but also record when exactly the temperature has exceeded a predefined tolerance band and for how long the temperature stayed outside the desirable range. The DS1921H/Z can log high and low durations. The tolerance band is specified by means of the Temperature Alarm Threshold Registers, addresses 20Bh and 20Ch in the register page. One can set a high and a low temperature threshold. See section *Temperature Conversion* for the data format the temperature has to be written in. As long as the temperature values stay within the tolerance band (i.e., are higher than the low threshold and lower than the high threshold), the DS1921H/Z will not record any temperature alarm. If the temperature during a mission reaches or exceeds either threshold, the DS1921H/Z will generate an alarm and set either the Temperature High Flag (THF) or the Temperature Low Flag (TLF) in the Status Register (address 214h). This way, if the search conditions (address 20Eh) are set accordingly, the master can quickly identify devices with temperature alarms by means of the Conditional Search function (see *ROM Function Commands*). The device also generates a time stamp of when the alarm occurred and begins recording the duration of the alarming temperature.

Time stamps and durations where the temperature leaves the tolerance band are stored in the address range 0220h to 027Fh, as shown in Figure 8. This allocation allows recording 24 individual alarm events

and periods (12 periods for too hot and 12 for too cold). The date and time of each of these periods can be determined from the Mission Time Stamp and the time distance between each temperature reading.

ALARM TIME STAMPS AND DURATIONS ADDRESS MAP Figure 8

| ADDRESS | DESCRIPTION | ALARM EVENT |
|----------------|-------------------------------------|---------------------|
| 0220h | Mission Samples Counter Low Byte | Low Alarm 1 |
| 0221h | Mission Samples Counter Center Byte | |
| 0222h | Mission Samples Counter High Byte | |
| 0223h | Alarm Duration Counter | |
| 0224h to 0227h | Alarm Time Stamp and Duration | Low Alarm 2 |
| 0228h to 024Fh | Alarm Time Stamp and Durations | Low Alarms 3 to 12 |
| 0250h | Mission Samples Counter Low Byte | High Alarm 1 |
| 0251h | Mission Samples Counter Center Byte | |
| 0252h | Mission Samples Counter High Byte | |
| 0253h | Alarm Duration Counter | |
| 0254h to 0257h | Alarm Time Stamp and Duration | High Alarm 2 |
| 0258h to 027Fh | Alarm Time Stamp and Durations | High Alarms 3 to 12 |

The alarm time stamp is a copy of the Mission Samples Counter when the alarm first occurred. The least significant byte is stored at the lower address. One address higher than the time stamp the DS1921H/Z maintains a 1-byte duration counter that stores the number of samples the temperature was found to be beyond the threshold. If this counter has reached its limit after 255 consecutive temperature readings and the temperature has not yet returned to within the tolerance band, the device will issue another time stamp at the next higher alarm location and open another counter to record the duration. If the temperature returns to normal before the counter has reached its limit, the duration counter of the particular time stamp will not increment any further. Should the temperature again cross this threshold, it will be recorded at the next available alarm location. This algorithm is implemented for the low as well as for the high temperature threshold.

MISSIONING

The typical task of the DS1921H/Z is recording the temperature of a temperature-sensitive object. Before the device can perform this function, it needs to be configured. This procedure is called missioning.

First of all, DS1921H/Z needs to have its RTC set to valid time and date. This reference time may be UTC (also called GMT, Greenwich Mean Time) or any other time standard that was chosen for the application. The clock must be running (EOSC = 0) for at least one second. Setting a RTC alarm is optional. The memory assigned to storing alarm time stamps and durations, temperature histogram, as well as the Mission Time Stamp, Mission Samples Counter, Mission Start Delay, and Sample Rate must be cleared using the Memory Clear command. In case there were temperature alarms in the previous mission, the TLF and THF flags need to be cleared manually. To enable the device for a mission, the EM flag must be set to 0. These are general settings that have to be made regardless of the type of object to be monitored and the duration of the mission.

Next, the low temperature and high temperature thresholds to specify the temperature tolerance band must be defined. How to convert a temperature value into the binary code to be written to the threshold registers is described under *Temperature Conversion* earlier in this document.

The state of the Search Condition bits in the Control Register does not affect the mission. If multiple devices are connected to form a 1-Wire net, the setting of the search condition will enable devices to participate in the conditional search if certain events such as timer or temperature alarm have occurred. Details on the search conditions are found in the section *ROM Function Commands* later in this document and in the Control Register description.

The setting of the RO bit (rollover enable) and sample rate depends on the duration of the mission and the monitoring requirements. If the most recent temperature history is important, the rollover should be enabled (RO = 1). Otherwise, one should estimate the duration of the mission in minutes and divide the number by 2048 to calculate the value of the sample rate (number of minutes between temperature conversions). If the estimated duration of a mission is 10 days (= 14400 minutes) for example, then the 2048-byte capacity of the datalog memory would be sufficient to store a new value every 7 minutes. If the datalog memory of the DS1921H/Z is not large enough to store all temperature readings, one can use several devices and set the Mission Start Delay to values that make the second device start recording as soon as the memory of the first device is full, and so on. The RO-bit needs to be set to 0 to disable rollover that would otherwise overwrite the recorded temperature log.

After the RO bit and the Mission Start Delay are set, the Sample Rate Register is the last element of data that is written. The sample rate may be any value from 1 to 255, coded as an unsigned 8-bit binary number. As soon as the sample rate is written, the DS1921H/Z will set the MIP flag and clear the MEMCLR flag. After as many minutes as specified by the Mission Start Delay are over, the device will wait for the next minute boundary, then wake up, copy the current time and date to the Mission Time Stamp Register, and make the first temperature conversion of the mission. This increments both the Mission Samples Counter and Device Samples Counter. All subsequent temperature measurements are taken on minute boundaries specified by the value in the Sample Rate Register. One may read the memory of the DS1921H/Z to watch the mission as it progresses. Care should be taken to avoid memory access conflicts. See section *Memory Access Conflicts* for details.

MEMORY/CONTROL FUNCTION COMMANDS

The *Memory/Control Function Flow Chart* (Figure 10) describes the protocols necessary for accessing the memory and the special function registers of the DS1921H/Z. An example on how to use these and other functions to set up the DS1921H/Z for a mission is included at the end of this document, preceding the *Electrical Characteristics* section. The communication between master and DS1921H/Z takes place either at regular speed (default, OD = 0) or at Overdrive Speed (OD = 1). If not explicitly set into the Overdrive mode, the DS1921H/Z assumes regular speed. Internal memory access during a mission has priority over external access through the 1-Wire interface. This can affect the Read Memory commands described below. See section *Memory Access Conflicts* for details.

ADDRESS REGISTERS AND TRANSFER STATUS

Because of the serial data transfer, the DS1921H/Z employs three address registers, called TA1, TA2, and E/S (Figure 9). Registers TA1 and TA2 must be loaded with the target address to which the data will be written or from which data will be sent to the master upon a Read command. Register E/S acts like a byte counter and transfer status register. It is used to verify data integrity with Write commands. Therefore, the master only has read access to this register. The lower 5 bits of the E/S Register indicate the address of the last byte that has been written to the scratchpad. This address is called Ending Offset. Bit 5 of the E/S Register, called PF or “partial byte flag,” is set if the number of data bits sent by the master is not an integer multiple of 8. Bit 6 is always a 0. Note that the lowest 5 bits of the target address also determine the address within the scratchpad, where intermediate storage of data will begin. This address is called

byte offset. If the target address for a Write command is 13Ch, for example, then the scratchpad will store incoming data beginning at the byte offset 1Ch and will be full after only 4 bytes. The corresponding ending offset in this example is 1Fh. For best economy of speed and efficiency, the target address for writing should point to the beginning of a new page, (i.e., the byte offset will be 0). Thus, the full 32-byte capacity of the scratchpad is available, resulting also in the ending offset of 1Fh. However, it is possible to write 1 or several contiguous bytes somewhere within a page. The ending offset together with the Partial and Overflow Flag is mainly a means to support the master checking the data integrity after a Write command. The highest valued bit of the E/S Register, called AA or Authorization Accepted, indicates that a valid copy command for the scratchpad has been received and executed. Writing data to the scratchpad clears this flag.

ADDRESS REGISTERS Figure 9

| Bit # | 7 | 6 | 5 | 4 | 3 | 2 | 1 | 0 |
|---|-----|-----|-----|-----|-----|-----|----|----|
| Target Address (TA1) | T7 | T6 | T5 | T4 | T3 | T2 | T1 | T0 |
| Target Address (TA2) | T15 | T14 | T13 | T12 | T11 | T10 | T9 | T8 |
| Ending Address with Data Status (E/S) (Read Only) | AA | 0 | PF | E4 | E3 | E2 | E1 | E0 |

WRITING WITH VERIFICATION

To write data to the DS1921H/Z, the scratchpad has to be used as intermediate storage. First, the master issues the Write Scratchpad command to specify the desired target address, followed by the data to be written to the scratchpad. In the next step, the master sends the Read Scratchpad command to read the scratchpad and to verify data integrity. As preamble to the scratchpad data, the DS1921H/Z sends the requested target address TA1 and TA2 and the contents of the E/S Register. If the PF flag is set, data did not arrive correctly in the scratchpad. The master does not need to continue reading; it can start a new trial to write data to the scratchpad. Similarly, a set AA flag indicates that the Write command was not recognized by the device. If everything went correctly, both flags are cleared and the ending offset indicates the address of the last byte written to the scratchpad. Now the master can continue verifying every data bit. After the master has verified the data, it has to send the Copy Scratchpad command. This command must be followed exactly by the data of the three address registers TA1, TA2 and E/S as the master has read them verifying the scratchpad. As soon as the DS1921H/Z has received these bytes, it will copy the data to the requested location beginning at the target address.

Write Scratchpad Command [0Fh]

After issuing the Write Scratchpad command, the master must first provide the 2-byte target address, followed by the data to be written to the scratchpad. The data will be written to the scratchpad starting at the byte offset (T4:T0). The ending offset (E4:E0) will be the byte offset at which the master stops writing data. Only full data bytes are accepted. If the last data byte is incomplete, its content will be ignored and the partial byte flag (PF) will be set.

When executing the Write Scratchpad command, the CRC generator inside the DS1921H/Z (see Figure 16) calculates a CRC of the entire data stream, starting at the command code and ending at the last data

byte sent by the master. This CRC is generated using the CRC16 polynomial by first clearing the CRC generator and then shifting in the command code (0Fh) of the Write Scratchpad command, the Target Addresses TA1 and TA2 as supplied by the master and all the data bytes. The master may end the Write Scratchpad command at any time. However, if the ending offset is 11111b, the master may send 16 read time slots and will receive an inverted CRC16 generated by the DS1921H/Z.

The range 200h to 213h of the register page is protected during a mission. See Figure 6, *Register Page Map*, for the access type of the individual registers between and during missions.

Read Scratchpad Command [AAh]

This command is used to verify scratchpad data and target address. After issuing the Read Scratchpad command, the master begins reading. The first 2 bytes will be the target address. The next byte will be the ending offset/data status byte (E/S) followed by the scratchpad data beginning at the byte offset (T4:T0), as shown in Figure 9. Regardless of the actual ending offset, the master may read data until the end of the scratchpad after which it will receive an inverted CRC16 of the command code, Target Addresses TA1 and TA2, the E/S byte, and the scratchpad data starting at the target address. After the CRC is read, the bus master will read logical 1s from the DS1921H/Z until a reset pulse is issued.

Copy Scratchpad [55h]

This command is used to copy data from the scratchpad to the writable memory sections. Applying Copy Scratchpad to the Sample Rate Register can start a mission provided that several preconditions are met. See *Mission Start and Logging Process* description and the flow chart in Figure 11 for details. After issuing the Copy Scratchpad command, the master must provide a 3-byte authorization pattern, which can be obtained by reading the scratchpad for verification. This pattern must exactly match the data contained in the three address registers (TA1, TA2, E/S, in that order). If the pattern matches, the AA (Authorization Accepted) flag will be set and the copy will begin. A pattern of alternating 1s and 0s will be transmitted after the data has been copied until the master issues a reset pulse. While the copy is in progress any attempt to reset the part will be ignored. Copy typically takes 2 μ s per byte.

The data to be copied is determined by the three address registers. The scratchpad data from the beginning offset through the ending offset will be copied, starting at the target address. Anywhere from 1 to 32 bytes may be copied to memory with this command. The AA flag will remain at logic 1 until it is cleared by the next Write Scratchpad command. Note that Copy Scratchpad when applied to the address range 200h to 213h during a mission will end the mission.

Read Memory [F0h]

The Read Memory command may be used to read the entire memory. After issuing the command, the master must provide the 2-byte target address. After the 2 bytes, the master reads data beginning from the target address and may continue until the end of memory, at which point logic 0s will be read. It is important to realize that the target address registers will contain the address provided. The ending offset/data status byte is unaffected.

The hardware of the DS1921H/Z provides a means to accomplish error-free writing to the memory section. To safeguard data in the 1-Wire environment when reading and to simultaneously speed up data transfers, it is recommended to packetize data into data packets of the size of one memory page each. Such a packet would typically store a 16-bit CRC with each page of data to ensure rapid, error-free data transfers that eliminate having to read a page multiple times to verify whether if the received data is correct. (See *Application Note 114* for the recommended file structure.)

MEMORY/CONTROL FUNCTION FLOW CHART Figure 10-1

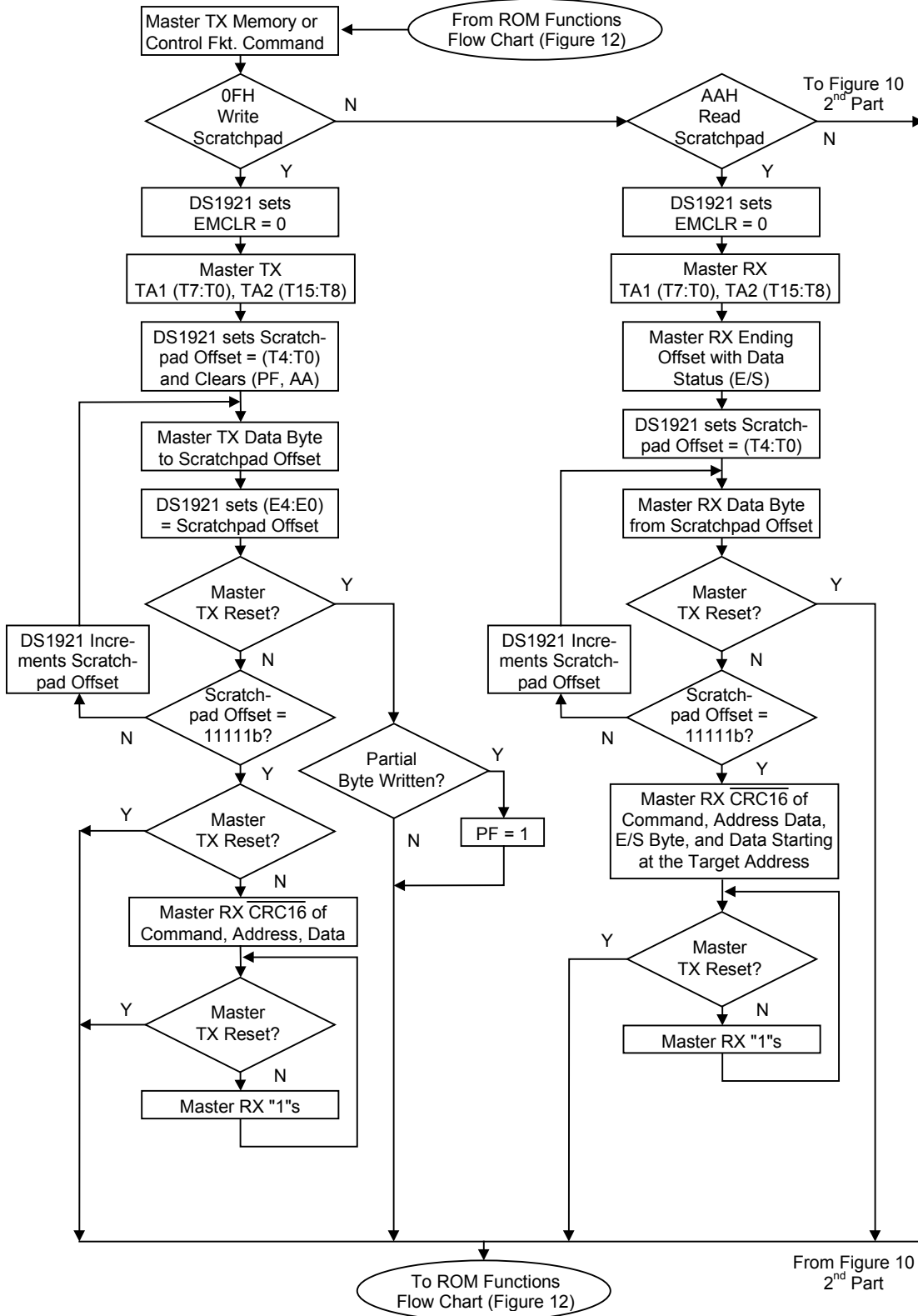

MEMORY/CONTROL FUNCTION FLOW CHART Figure 10-2

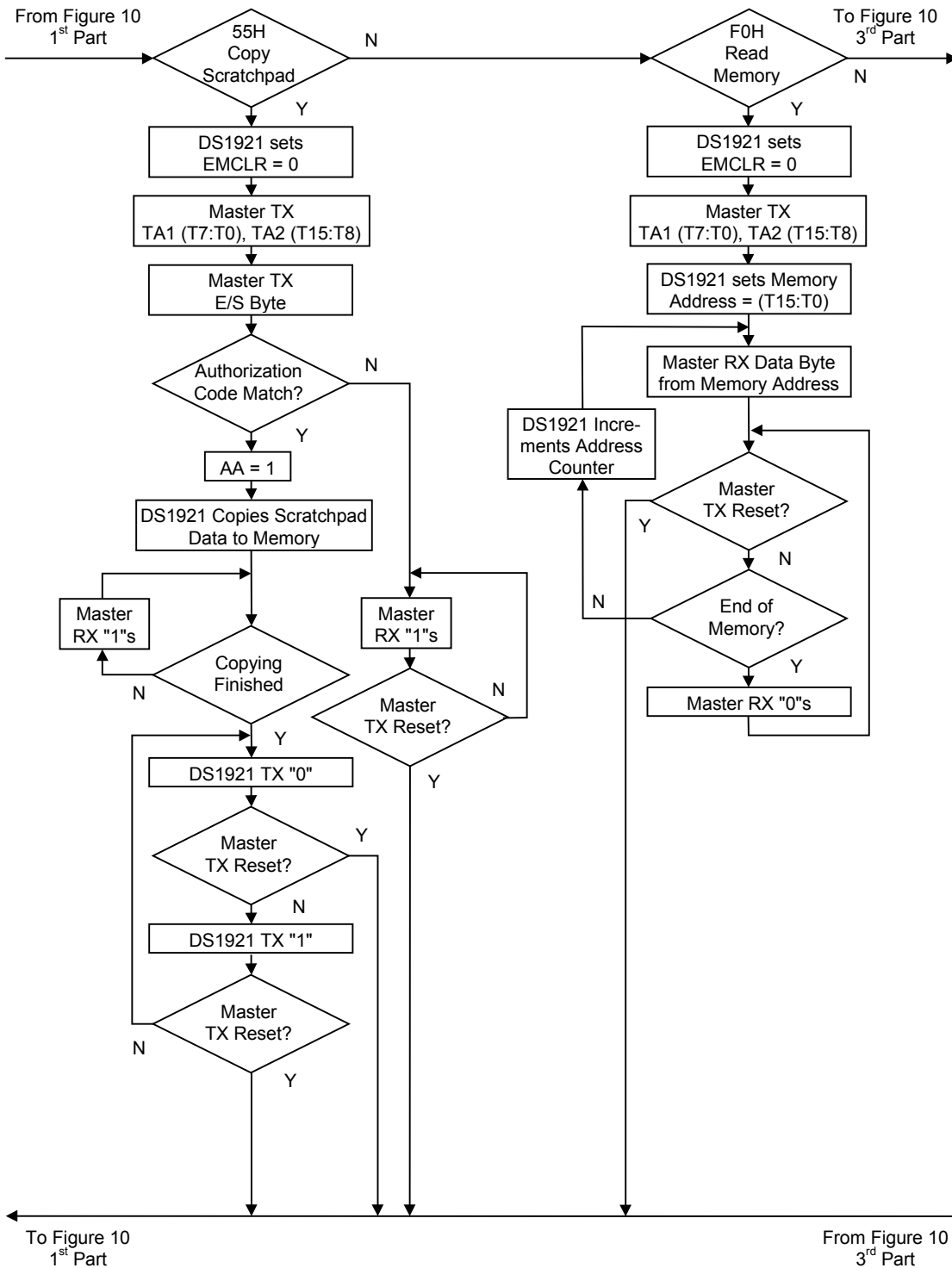

MEMORY/CONTROL FUNCTION FLOW CHART Figure 10-3

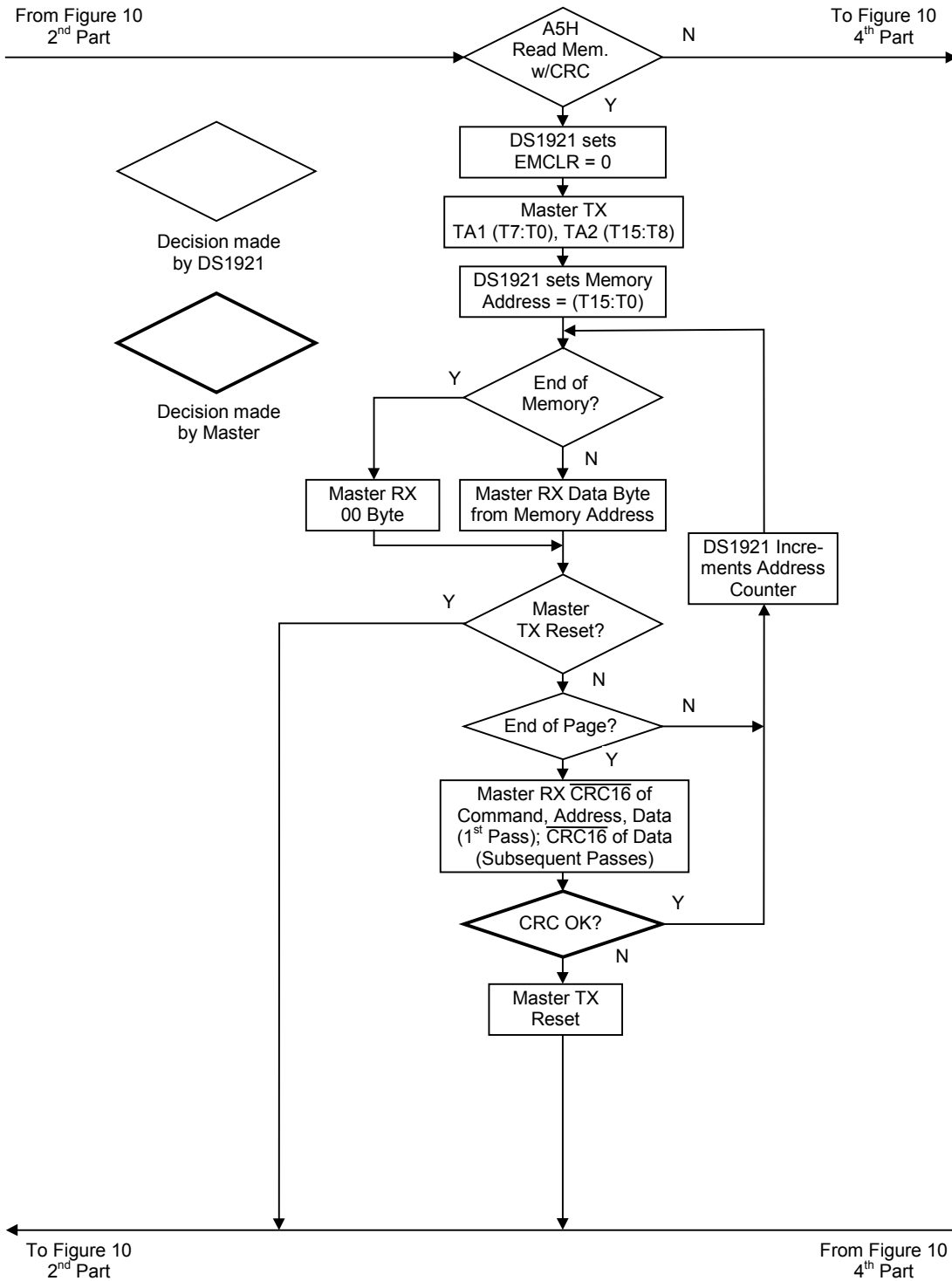

MEMORY/CONTROL FUNCTION FLOW CHART Figure 10-4

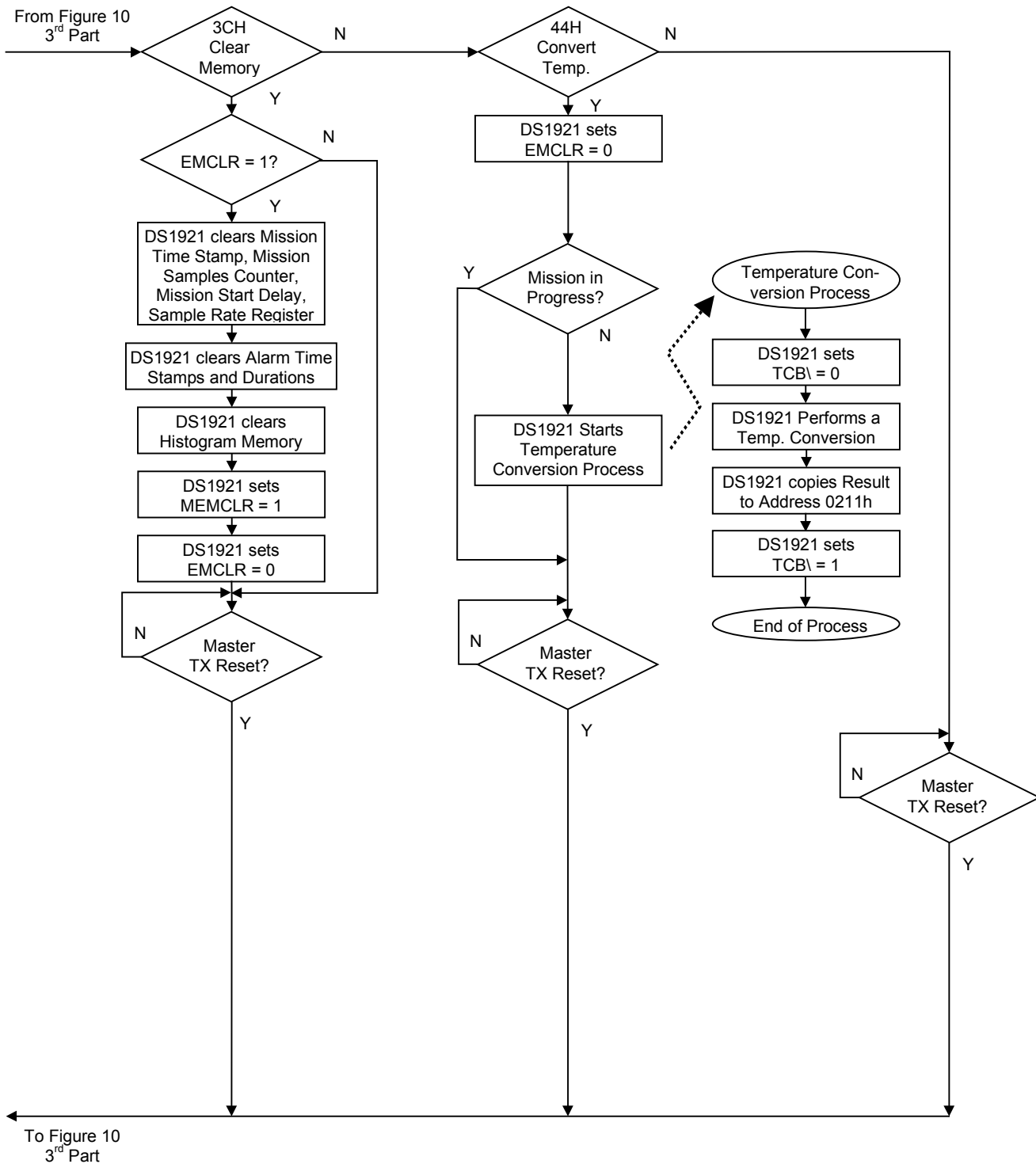

Read Memory with CRC [A5h]

The Read Memory with CRC command is used to read memory data that cannot be packetized, such as the register page and the data recorded by the device during a mission. The command works essentially the same way as the simple Read Memory, except for the 16-bit CRC that the DS1921H/Z generates and transmits following the last data byte of a memory page.

After having sent the command code of the Read Memory with CRC command, the bus master sends a 2-byte address (TA1 = T7:T0, TA2 = T15:T8) that indicates a starting byte location. With the subsequent read data time slots the master receives data from the DS1921H/Z starting at the initial address and continuing until the end of a 32-byte page is reached. At that point the bus master will send 16 additional read data time slots and receive an inverted 16-bit CRC. With subsequent read data time slots the master will receive data starting at the beginning of the next page followed again by the inverted CRC for that page. This sequence will continue until the bus master resets the device.

With the initial pass through the Read Memory with CRC flow, the 16-bit CRC value is the result of shifting the command byte into the cleared CRC generator followed by the two address bytes and the contents of the data memory. Subsequent passes through the Read Memory with CRC flow will generate a 16-bit CRC that is the result of clearing the CRC generator and then shifting in the contents of the data memory page. After the 16-bit CRC of the last page is read, the bus master will receive logical 0s from the DS1921H/Z and inverted CRC16s at page boundaries until a reset pulse is issued. The Read Memory with CRC command sequence can be ended at any point by issuing a reset pulse.

Clear Memory [3Ch]

The Clear Memory command is used to clear the Sample Rate, Mission Start Delay, Mission Time Stamp, and Mission Samples Counter in the register page and the Temperature Alarm Memory and the Temperature Histogram Memory. These memory areas must be cleared for the device to be set up for another mission. The Clear Memory command does not clear the datalog memory or the temperature and timer alarm flags in the Status Register. The RTC oscillator must be on and have counted at least 1 second, before issuing the command. For the Clear Memory command to function the EMCLR bit in Control Register must be set to 1, and the Clear Memory command must be issued with the very next access to the device's memory functions. Issuing any other memory function command will reset the EMCLR bit. The Clear Memory process takes 500 μ s. When the command is completed the MEMCLR bit in the Status Register will read 1 and the EMCLR bit will be 0.

Convert Temperature [44h]

If a mission is not in progress (MIP = 0) the Convert Temperature command can be issued to measure the current temperature of the device. The result of the temperature conversion will be found at memory address 211h in the register page. This command takes maximum 360ms to complete. During this time the device remains fully accessible for memory/control and ROM function commands.

Mission Start and Logging Process

The DS1921H/Z does not use a special command to start a mission. Instead, a mission is started by writing a non-zero value to the Sample Rate Register using the Copy Scratchpad command. As shown in Figure 11, a new mission can only be started if the previous mission has been stopped (MIP = 0), the memory is cleared (MEMCLR = 1) and the mission is enabled (EM = 0). If the new sample rate is different from zero, the value will be copied to the sample rate register. At the same time the MIP bit will be set and the MEMCLR bit will be cleared to indicate that the device is on a mission. Next the Mission Start Delay counter will start decrementing every minute until it is down to 0. Now the DS1921H/Z will wait until the next minute boundary and start the logging process, which as its first action copies the applicable RTC registers to the Mission Time Stamp.

MISSION START AND LOGGING PROCESS Figure 11

The Mission Start Process is invoked when the Copy Scratchpad function is used to set a new sample rate by writing to the Sample Rate Register at address 020Dh. One minute after the start delay countdown is over, the Logging Process begins and the Mission Start Process ends.

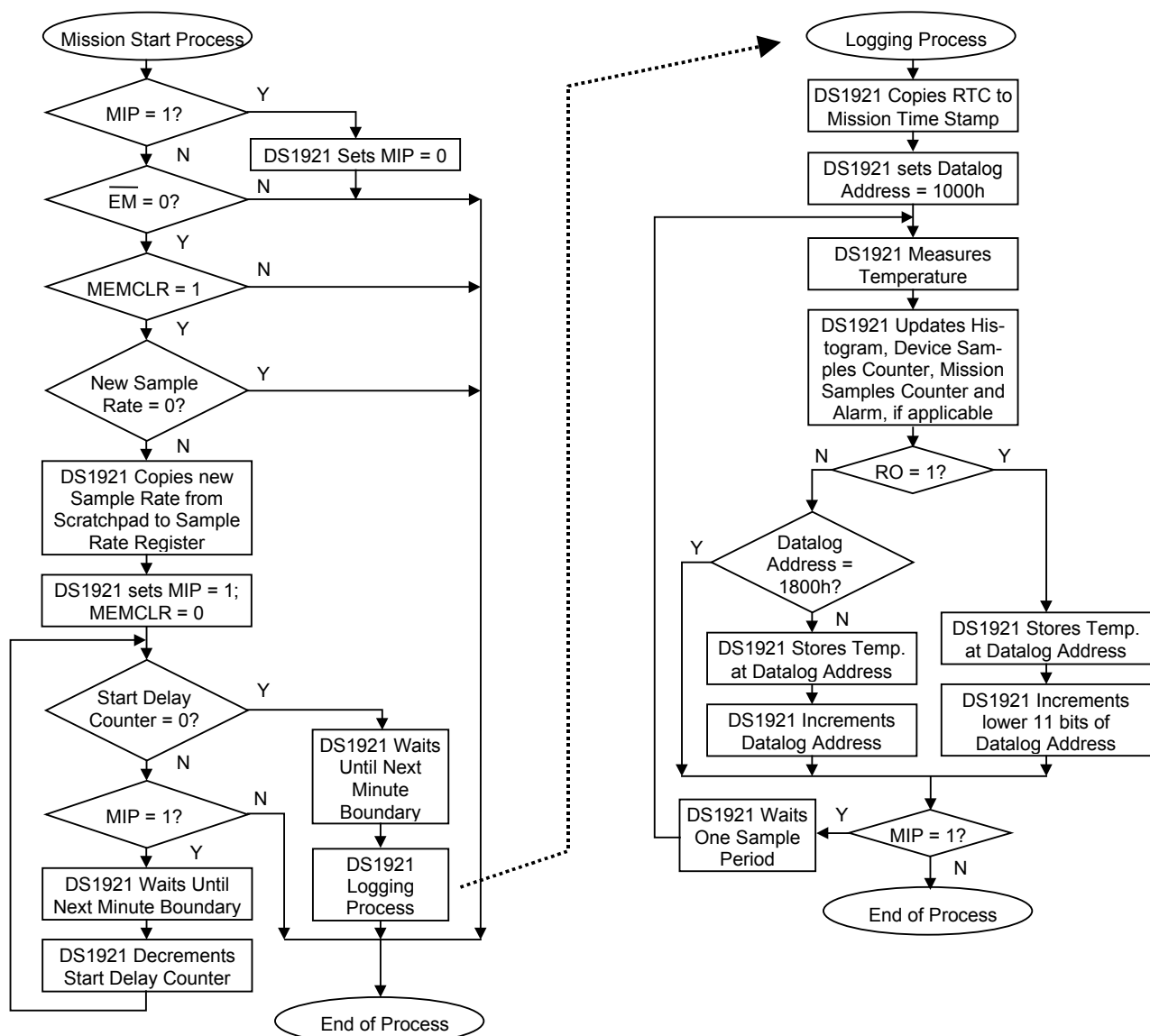

Stop Mission

The DS1921H/Z does not have a special command to stop a mission. A mission can be stopped at any time by writing to any address in the range of 0200h to 0213h or by writing the MIP bit of the Status Register at address 0214h to 0. Either approach involves the use of the Copy Scratchpad command. There is no need for the Mission Start Delay to expire before a mission can be stopped (see Figure 11).

MEMORY ACCESS CONFLICTS

While a mission is in progress, periodically a temperature sample is taken and stored in the datalog, histogram, and potentially alarm memory. This “internal activity” has priority over a Read Memory or Read Memory with CRC access to these pages. If a conflict occurs, the data read may be invalid, even if the CRC value matches the data. To ensure that the data read is valid, it is recommended to first read the SIP bit of the Status Register. If the SIP bit is set, delay reading the datalog, histogram, and alarm memory until SIP is 0. The interference is more likely to be seen with a high sample rate (1 sample every minute). Since all mission samples occur on the seconds rollover (59 to 00), memory conflicts can be avoided by first reading the RTC seconds counter. For example, if it takes two seconds to read the datalog, then avoid starting the memory read if the seconds counter is 58, 59 or 00. Alternatively, one can read the affected memory section twice and accept the data only if both readings match. In any case, when writing driver software, it is important to know about the possibility of interference and to take measures to work around it.

1-WIRE BUS SYSTEM

The 1-Wire bus is a system that has a single bus master and one or more slaves. In all instances the DS1921H/Z is a slave device. The bus master is typically a microcontroller. The discussion of this bus system is broken down into three topics: hardware configuration, transaction sequence, and 1-Wire signaling (signal types and timing). The 1-Wire protocol defines bus transactions in terms of the bus state during specific time slots that are initiated on the falling edge of sync pulses from the bus master.

HARDWARE CONFIGURATION

The 1-Wire bus has only a single line by definition; it is important that each device on the bus be able to drive it at the appropriate time. To facilitate this, each device attached to the 1-Wire bus must have open drain or tri-state outputs. The 1-Wire port of the DS1921H/Z is open-drain with an internal circuit equivalent to that shown in Figure 12.

A multidrop bus consists of a 1-Wire bus with multiple slaves attached. At standard speed the 1-Wire bus has a maximum data rate of 16.3kbits per second. The speed can be boosted to 142kbits per second by activating the Overdrive mode. The DS1921H/Z is not guaranteed to be fully compliant to the iButton device standard. Its maximum data rate in standard speed mode is 15.4kbits per second and 125kbits per second in Overdrive. The value of the pull-up resistor primarily depends on the network size and load conditions. The DS1921H/Z requires a pull-up resistor of maximum 2.2k Ω at any speed.

The idle state for the 1-Wire bus is high. If for any reason a transaction needs to be suspended, the bus must be left in the idle state if the transaction is to resume. If this does not occur and the bus is left low for more than 16 μ s (Overdrive speed) or more than 120 μ s (standard speed), one or more devices on the bus may be reset. Note that the DS1921H/Z does not quite meet the full 16 μ s maximum low time of the normal 1-Wire bus Overdrive timing. With the DS1921H/Z the bus must be left low for no longer than 15 μ s at Overdrive speed to ensure that no DS1921H/Z on the 1-Wire bus performs a reset. The DS1921H/Z will communicate properly when used in conjunction with a DS2480B or DS2490 1-Wire driver and adapters that are based on these driver chips.

HARDWARE CONFIGURATION Figure 12

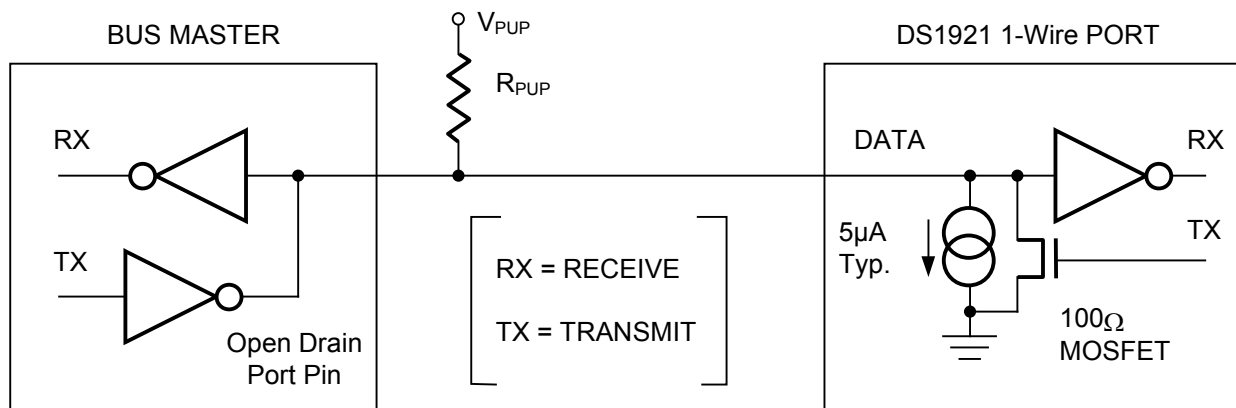

TRANSACTION SEQUENCE

The protocol for accessing the DS1921H/Z via the 1-Wire port is as follows:

- Initialization
- ROM Function Command
- Memory/Control Function Command
- Transaction/Data

INITIALIZATION

All transactions on the 1-Wire bus begin with an initialization sequence. The initialization sequence consists of a reset pulse transmitted by the bus master followed by presence pulse(s) transmitted by the slave(s). The presence pulse lets the bus master know that the DS1921H/Z is on the bus and is ready to operate. For more details, see the *1-Wire Signaling* section.

ROM FUNCTION COMMANDS

Once the bus master has detected a presence, it can issue one of the seven ROM function commands. All ROM function commands are eight bits long. A list of these commands follows (refer to flowchart in Figure 13).

Read ROM [33h]

This command allows the bus master to read the DS1921H/Z's 8-bit family code, temperature range code, plus unique 36-bit serial number and 8-bit CRC. This command can only be used if there is a single slave on the bus. If more than one slave is present on the bus, a data collision will occur when all slaves try to transmit at the same time (open drain will produce a wired-AND result). The resultant family code and temperature range code plus 36-bit serial number will result in a mismatch of the CRC.

Match ROM [55h]

The Match ROM command, followed by a 64-bit ROM sequence, allows the bus master to address a specific DS1921H/Z on a multidrop bus. Only the DS1921H/Z that exactly matches the 64-bit ROM sequence will respond to the following memory function command. All other slaves will wait for a reset pulse. This command can be used with a single or multiple devices on the bus.

Search ROM [F0h]

When a system is initially brought up, the bus master might not know the number of devices on the 1-Wire bus or their registration numbers. By taking advantage of the wired-AND property of the bus, the master can use a process of elimination to identify the registration numbers of all slave devices. For each bit of the registration number, starting with the least significant bit, the bus master issues a triplet of time slots. On the first slot, each slave device participating in the search outputs the true value of its registration number bit. On the second slot, each slave device participating in the search outputs the complemented value of its registration number bit. On the third slot, the master writes the true value of the bit to be selected. All slave devices that do not match the bit written by the master stop participating in the search. If both of the read bits are zero, the master knows that slave devices exist with both states of the bit. By choosing which state to write, the bus master branches in the romcode tree. After one complete pass, the bus master knows the registration number of a single device. Additional passes identify the registration numbers of the remaining devices. Refer to App Note 187: *1-Wire Search Algorithm* for a detailed discussion, including an example.

Conditional Search [ECh]

The Conditional Search ROM command operates similarly to the Search ROM command except that only devices fulfilling the specified condition will participate in the search. The condition is specified by the bit functions TAS, THS, and TLS in the Control Register, address 20Eh. The Conditional Search ROM provides an efficient means for the bus master to determine devices on a multidrop system that have to signal an important event, such as a temperature leaving the tolerance band. After each pass of the conditional search that successfully determined the 64-bit ROM code for a specific device on the multidrop bus, that particular device can be individually accessed as if a Match ROM had been issued, since all other devices will have dropped out of the search process and will be waiting for a reset pulse.

For the conditional search, one can select any combination of the three search conditions by writing the associated bit to a logical 1. These bits correspond directly to the flags in the Status Register of the device. If the flag in the status register reads 1 and the corresponding bit in the Control Register is a logical 1 too, the device will respond to the Conditional Search command. If more than one bit search condition is selected, the first event occurring will make the device respond to the Conditional Search command.

Skip ROM [CCh]

This command can save time in a single-drop bus system by allowing the bus master to access the memory functions without providing the 64-bit ROM code. If more than one slave is present on the bus and, for example, a Read command is issued following the Skip ROM command, data collision will occur on the bus as multiple slaves transmit simultaneously (open drain pull-downs will produce a wired-AND result).

ROM FUNCTIONS FLOW CHART Figure 13-1

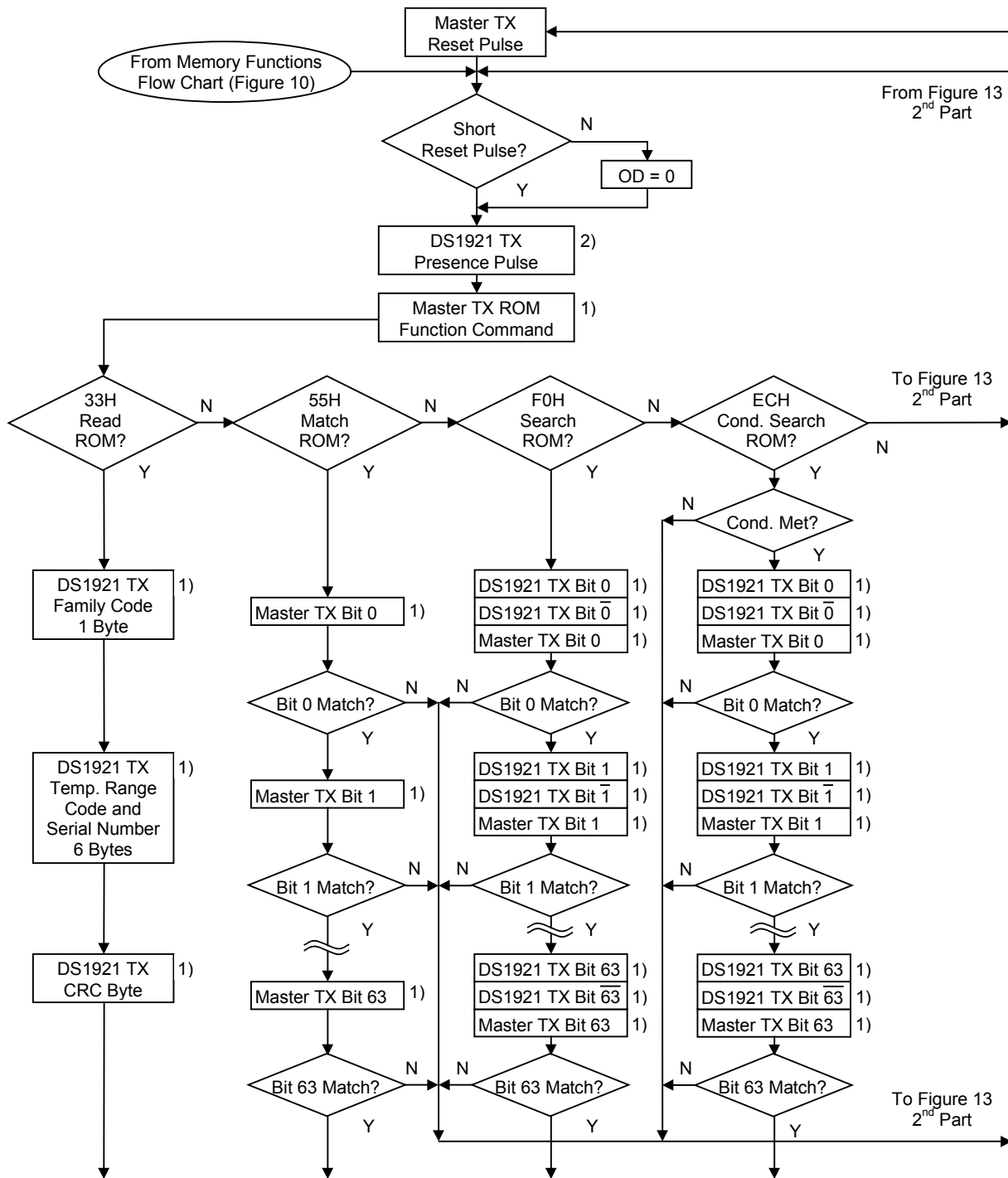

- 1) To be transmitted or received at Overdrive speed if OD = 1.
- 2) The Presence Pulse will be short if OD = 1.

From Figure 13 2nd Part

To Memory Functions Flow Chart (Figure 10)

ROM FUNCTIONS FLOW CHART Figure 13-2

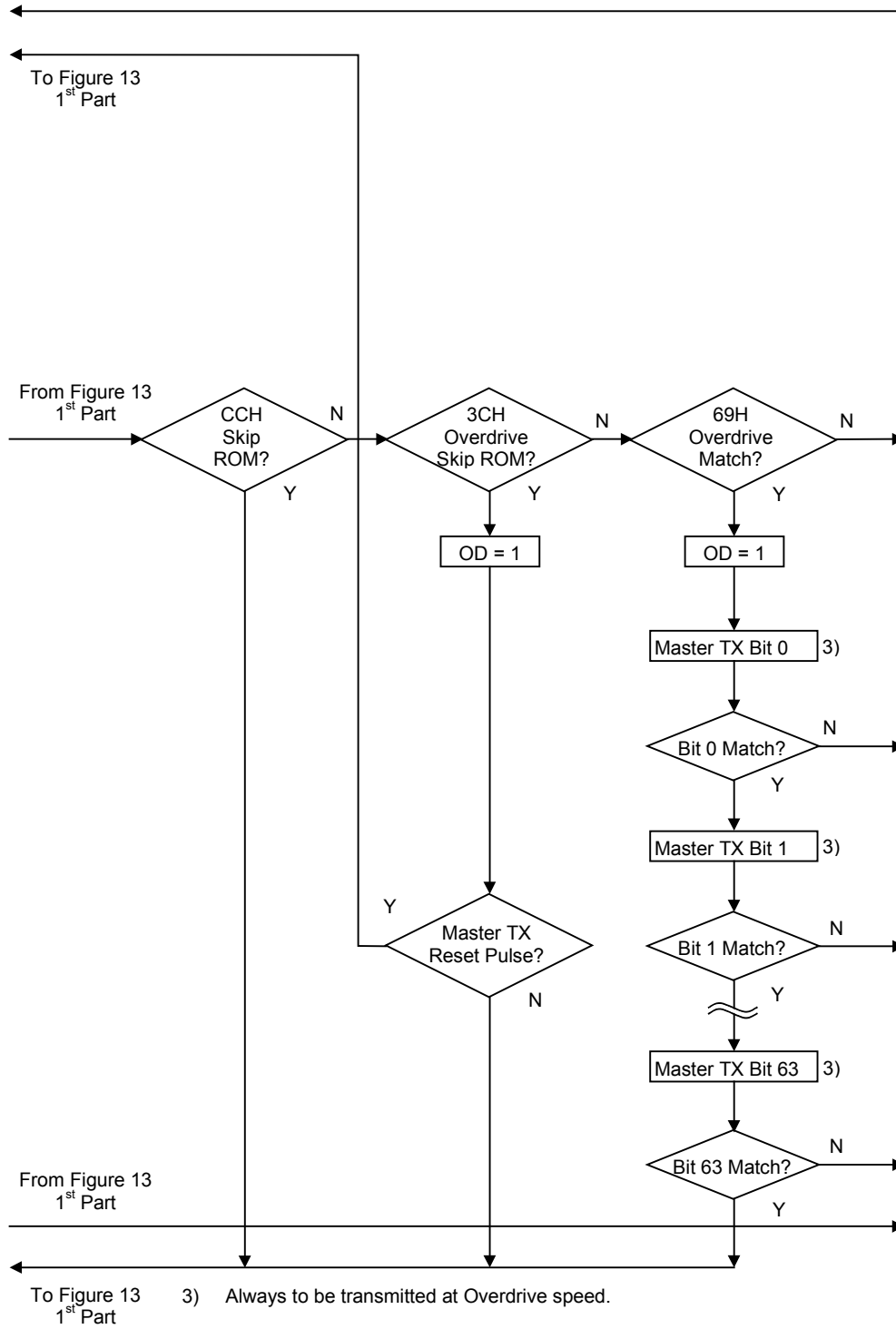

Overdrive Skip ROM [3Ch]

On a single-drop bus this command can save time by allowing the bus master to access the memory/control functions without providing the 64-bit ROM code. Unlike the normal Skip ROM command, the Overdrive Skip ROM sets the DS1921H/Z in the Overdrive mode (OD = 1). All communication following this command has to occur at Overdrive speed until a reset pulse of minimum 480 μ s duration resets all devices on the bus to standard speed (OD = 0).

When issued on a multidrop bus this command will set all Overdrive-supporting devices into Overdrive mode. To subsequently address a specific Overdrive-supporting device, a reset pulse at Overdrive speed has to be issued followed by a Match ROM or Search ROM command sequence. This will speed up the time for the search process. If more than one slave supporting Overdrive is present on the bus and the Overdrive Skip ROM command is followed by a Read command, data collision will occur on the bus as multiple slaves transmit simultaneously (open-drain pull-downs will produce a wired-AND result).

Overdrive Match ROM [69h]

The Overdrive Match ROM command followed by a 64-bit ROM sequence transmitted at Overdrive Speed allows the bus master to address a specific DS1921H/Z on a multidrop bus and to simultaneously set it in Overdrive mode. Only the DS1921H/Z that exactly matches the 64-bit ROM sequence will respond to the subsequent memory/control function command. Slaves already in Overdrive mode from a previous Overdrive Skip or successful Overdrive Match command will remain in Overdrive mode. All overdrive-capable slaves will return to standard speed at the next Reset Pulse of minimum 480 μ s duration. The Overdrive Match ROM command can be used with a single or multiple devices on the bus.

1-WIRE SIGNALING

The DS1921H/Z requires strict protocols to ensure data integrity. The protocol consists of four types of signaling on one line: Reset Sequence with Reset Pulse and Presence Pulse, Write 0, Write 1, and Read Data. Except for the presence pulse the bus master initiates all these signals. The DS1921H/Z can communicate at two different speeds: standard speed and Overdrive speed. If not explicitly set into the Overdrive mode, the DS1921H/Z will communicate at standard speed. While in Overdrive mode the fast timing applies to all waveforms.

To get from idle to active, the voltage on the 1-Wire line needs to fall from V_{PUP} below the threshold V_{TL} . To get from active to idle, the voltage needs to rise from V_{ILMAX} past the threshold V_{TH} . The time it takes for the voltage to make this rise is seen in Figure 14 as ‘ ϵ ’ and its duration depends on the pull-up resistor (R_{PUP}) used and capacitance of the 1-Wire network attached. The voltage V_{ILMAX} is relevant for the DS1921H/Z when determining a logical level, but not for triggering any events.

The initialization sequence required to begin any communication with the DS1921H/Z is shown in Figure 14. A Reset Pulse followed by a Presence Pulse indicates the DS1921H/Z is ready to receive data, given the correct ROM and memory function command. If the bus master uses slew-rate control on the falling edge, it must pull down the line for $t_{RSTL} + t_F$ to compensate for the edge. A t_{RSTL} duration of 480 μ s or longer will exit the Overdrive mode returning the device to standard speed. If the DS1921H/Z is in Overdrive mode and t_{RSTL} is no longer than 80 μ s, the device will remain in Overdrive mode.

INITIALIZATION PROCEDURE (RESET AND PRESENCE PULSES) Figure 14

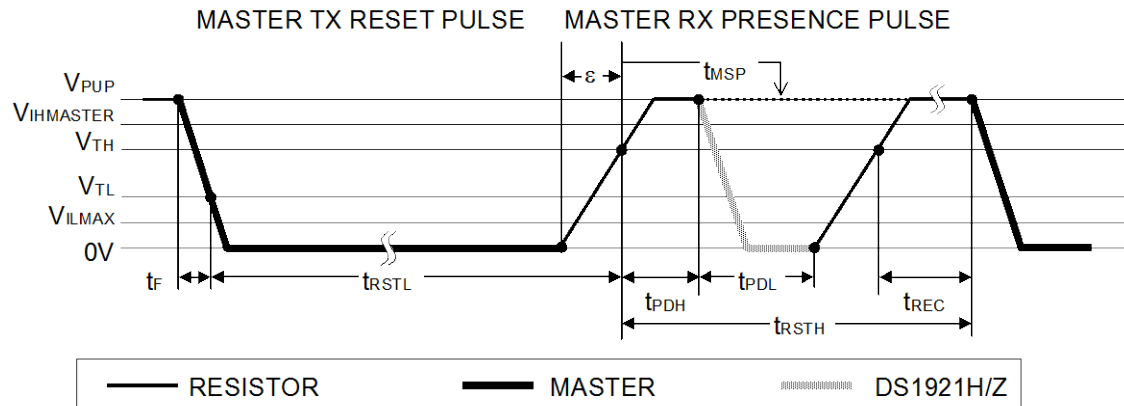

After the bus master has released the line it goes into receive mode (RX). Now, the 1-Wire bus is pulled to V_{PUP} via the pull-up resistor or, in case of a DS2480B driver, by active circuitry. When the threshold V_{TH} is crossed, the DS1921H/Z waits for t_{PDH} and then transmits a presence pulse by pulling the line low for t_{PDL} . To detect a presence pulse, the master must test the logical state of the 1-Wire line at t_{MSP} .

The t_{RSTH} window must be at least the sum of t_{PDHMAX} , t_{PDLMAX} , and t_{RECMIN} . Immediately after t_{RSTH} is expired, the DS1921H/Z is ready for data communication. In a mixed population network, t_{RSTH} should be extended to minimum $480\mu s$ at standard speed and $48\mu s$ at Overdrive speed to accommodate other 1-Wire devices.

Read/Write Time Slots

Data communication with the DS1921H/Z takes place in time slots that carry a single bit each. Write time slots transport data from bus master to slave. Read time-slots transfer data from slave to master. The definitions of the write and read time slots are illustrated in Figure 15.

All communication begins with the master pulling the data line low. As the voltage on the 1-Wire line falls below the threshold V_{TL} , the DS1921H/Z starts its internal timing generator that determines when the data line will be sampled during a write time slot and how long data will be valid during a read time slot.

Master to Slave

For a **write-one** time slot, the voltage on the data line must have crossed the V_{TH} threshold after the write-one low time t_{WILMAX} is expired. For a **write-zero** time slot, the voltage on the data line must stay below the V_{TH} threshold until the write-zero low time t_{WOLMIN} is expired. The voltage on the data line should not exceed V_{ILMAX} during the entire t_{WOL} or t_{WIL} window. After the V_{TH} threshold has been crossed, the DS1921H/Z needs a recovery time t_{REC} before it is ready for the next time slot.

READ/WRITE TIMING DIAGRAM Figure 15

Write-One Time Slot

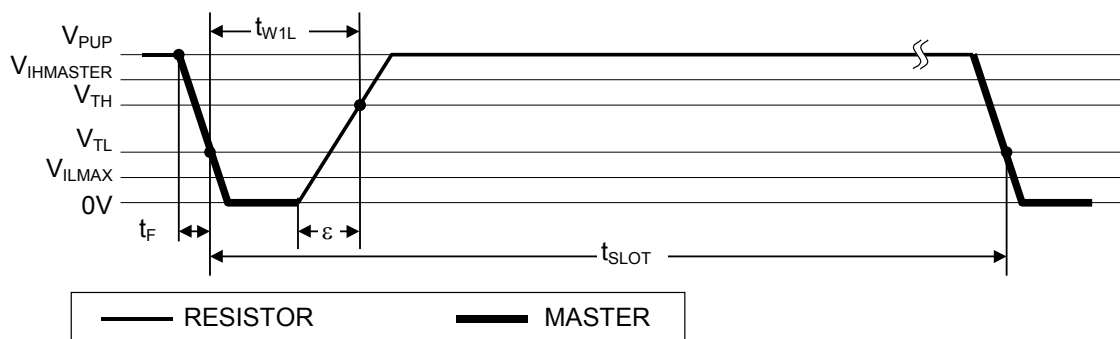

Write-Zero Time Slot

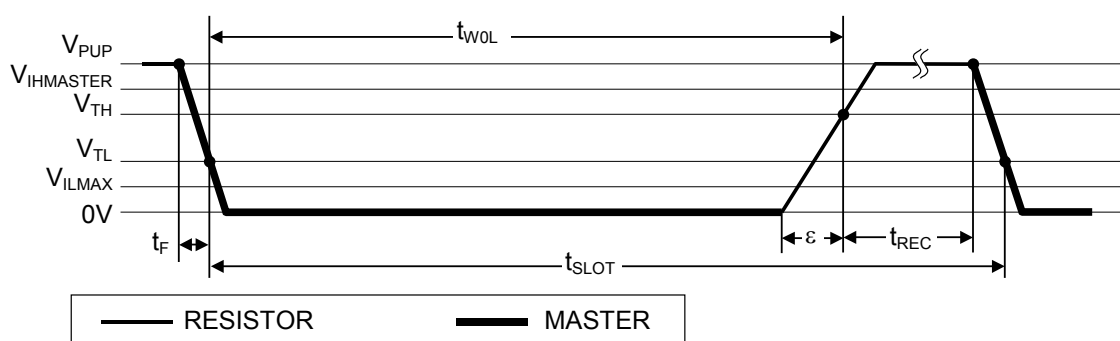

Read-Data Time Slot

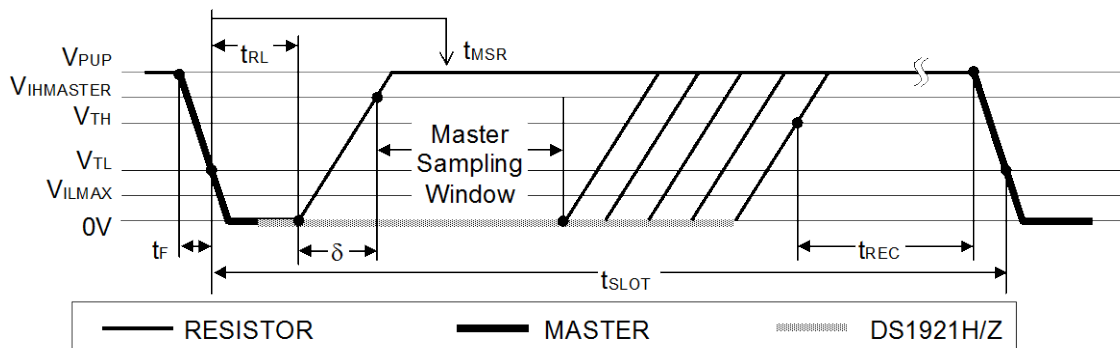

Slave to Master

A **read-data** time slot begins like a write-one time slot. The voltage on the data line must remain below V_{TL} until the read low time t_{RL} is expired. During the t_{RL} window, when responding with a 0, the DS1921H/Z will start pulling the data line low; its internal timing generator determines when this pull-down ends and the voltage starts rising again. When responding with a 1, the DS1921H/Z will not hold the data line low at all, and the voltage starts rising as soon as t_{RL} is over.

The sum of $t_{RL} + \delta$ (rise time) on one side and the internal timing generator of the DS1921H/Z on the other side define the master sampling window (t_{MSRMIN} to t_{MSRMAX}) in which the master must perform a read from the data line. For most reliable communication, t_{RL} should be as short as permissible and the master should read close to but no later than t_{MSRMAX} . After reading from the data line, the master must wait until t_{SLOT} is expired. This guarantees sufficient recovery time t_{REC} for the DS1921H/Z to get ready for the next time slot.

CRC GENERATION

With the DS1921H/Z there are two different types of Cyclic Redundancy Checks (CRCs). One CRC is an 8-bit type and is stored in the most significant byte of the 64-bit ROM. The bus master can compute a CRC value from the first 56 bits of the 64-bit ROM and compare it to the value stored within the DS1921H/Z to determine if the ROM data has been received error-free. The equivalent polynomial function of this CRC is $X^8 + X^5 + X^4 + 1$. This 8-bit CRC is received in the true (noninverted) form. It is computed at the factory and lasered into the ROM.

The other CRC is a 16-bit type, generated according to the standardized CRC16-polynomial function $X^{16} + X^{15} + X^2 + 1$. This CRC is used for error detection when reading data memory using the Read Memory with CRC command and for fast verification of a data transfer when writing to or reading from the scratchpad. In contrast to the 8-bit CRC, the 16-bit CRC is always communicated in the inverted form. A CRC-generator inside the DS1921H/Z chip (Figure 16) will calculate a new 16-bit CRC as shown in the command flow chart of Figure 10. The bus master compares the CRC value read from the device to the one it calculates from the data and decides whether to continue with an operation or to reread the portion of the data with the CRC error. With the initial pass through the Read Memory with CRC flow chart, the 16-bit CRC value is the result of shifting the command byte into the cleared CRC generator, followed by the 2 address bytes and the data bytes. Subsequent passes through the Read Memory with CRC flow chart will generate a 16-bit CRC that is the result of clearing the CRC generator and then shifting in the data bytes.

With the Write Scratchpad command the CRC is generated by first clearing the CRC generator and then shifting in the command code, the target addresses TA1 and TA2 and all the data bytes. The DS1921H/Z will transmit this CRC only if the data bytes written to the scratchpad include scratchpad ending offset 11111b. The data may start at any location within the scratchpad.

With the Read Scratchpad command the CRC is generated by first clearing the CRC generator and then shifting in the command code, the target addresses (TA1 and TA2), the E/S byte, and the scratchpad data starting at the target address. The DS1921H/Z will transmit this CRC only if the reading continues through the end of the scratchpad, regardless of the actual ending offset. For more information on generating CRC values see *Application Note 27*.

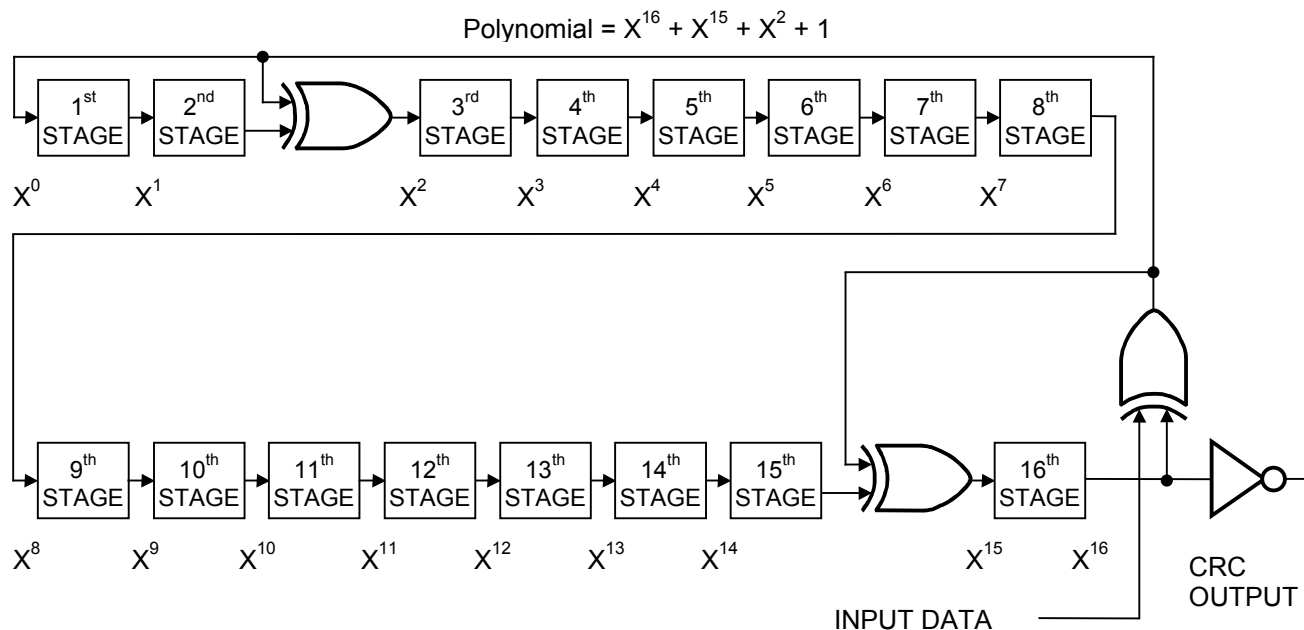
CRC-16 HARDWARE DESCRIPTION AND POLYNOMIAL Figure 16**Command-Specific 1-Wire Communication Protocol — Legend**

| Symbol | Description |
|---------------|---|
| RST | 1-Wire Reset Pulse generated by master |
| PD | 1-Wire Presence Pulse generated by slave |
| Select | Command and data to satisfy the ROM function protocol (Skip ROM, Search ROM, etc.) |
| WS | Command "Write Scratchpad" |
| RS | Command "Read Scratchpad" |
| CPS | Command "Copy Scratchpad" |
| RM | Command "Read Memory" |
| RMC | Command "Read Memory with CRC" |
| CM | Command "Clear Memory" |
| CT | Command "Convert Temperature" |
| TA | Target Address TA1, TA2 |
| TA-E/S | Target Address TA1, TA2 with E/S byte |
| <data to EOS> | Transfer of as many data bytes as are needed to reach the scratchpad offset 1Fh |
| <data to EOP> | Transfer of as many data bytes as are needed to reach the end of a memory page |
| <data to EOM> | Transfer of as many data bytes as are needed to reach the end of the datalog memory |
| <00 to EOP> | Transfer of as many 00h bytes as are needed to reach a memory page boundary |
| <32 bytes> | Transfer of 32 bytes |
| <data> | Transfer of an undetermined amount of data |
| CRC16\ | Transfer of an inverted CRC16 |
| FF loop | Indefinite loop where the master reads FFh bytes |
| AA loop | Indefinite loop where the master reads AAh bytes |
| Busy | Interval during Copy Scratchpad where the DS1921H/Z does not respond. Any bits read during this time are logic 1. |
| 00 loop | Indefinite loop where the master reads 00h bytes |

Command-Specific 1-Wire Communication Protocol — Color Codes

| | |
|-----------------|-----------------|
| Master to slave | Slave to master |
|-----------------|-----------------|

Write Scratchpad, reaching the end of the Scratchpad

| | | | | | | | |
|-----|----|--------|----|----|---------------|--------|---------|
| RST | PD | Select | WS | TA | <data to EOS> | CRC16\ | FF loop |
|-----|----|--------|----|----|---------------|--------|---------|

Write Scratchpad, not reaching the end of the Scratchpad

| | | | | | | | |
|-----|----|--------|----|----|--------|-----|----|
| RST | PD | Select | WS | TA | <data> | RST | PD |
|-----|----|--------|----|----|--------|-----|----|

Read Scratchpad

| | | | | | | | |
|-----|----|--------|----|--------|---------------|--------|---------|
| RST | PD | Select | RS | TA-E/S | <data to EOS> | CRC16\ | FF loop |
|-----|----|--------|----|--------|---------------|--------|---------|

Copy Scratchpad (success)

| | | | | | | |
|-----|----|--------|-----|--------|------|---------|
| RST | PD | Select | CPS | TA-E/S | Busy | AA loop |
|-----|----|--------|-----|--------|------|---------|

Copy Scratchpad (invalid TA-E/S)

| | | | | | |
|-----|----|--------|-----|--------|---------|
| RST | PD | Select | CPS | TA-E/S | FF loop |
|-----|----|--------|-----|--------|---------|

Read Memory (success)

| | | | | | | |
|-----|----|--------|----|----|---------------|---------|
| RST | PD | Select | RM | TA | <data to EOM> | 00 loop |
|-----|----|--------|----|----|---------------|---------|

Read Memory (invalid address)

| | | | | | |
|-----|----|--------|----|----|---------|
| RST | PD | Select | RM | TA | 00 loop |
|-----|----|--------|----|----|---------|

Reading reserved pages 20 through 63 or 68 through 127 or pages 192 and higher (beyond datalog memory) will result in 00h bytes.

Read Memory with CRC (success)

| | | | | | | | | |
|-----|----|--------|-----|----|---------------|--------|------------|--------|
| RST | PD | Select | RMC | TA | <data to EOP> | CRC16\ | <32 bytes> | CRC16\ |
|-----|----|--------|-----|----|---------------|--------|------------|--------|

Loop

The "32 bytes" are either valid page data or 00h bytes when reading reserved pages 20 through 63 or 68 through 127 or pages 192 and higher (beyond datalog memory).

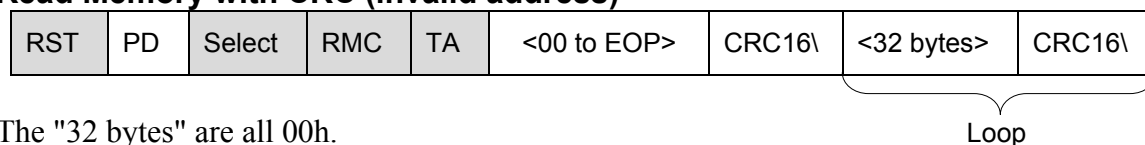
Read Memory with CRC (invalid address)

The "32 bytes" are all 00h.

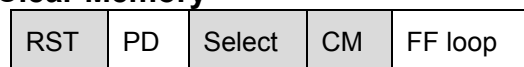
Clear Memory

To verify success, read the Status Register at address 0214h. If MEMCLR is 1, the command was executed successfully.

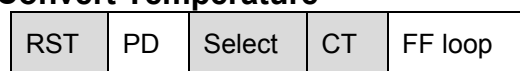
Convert Temperature

To read the result and to verify success, read the addresses 0211h (result) and the Device Samples Counter at address 021Dh to 021Fh. If the count has incremented, the command was executed successfully.

MISSION EXAMPLE: PREPARE AND START A NEW MISSION

Assumption: The previous mission has come to an end. To end an ongoing mission write the MIP bit in the Status Register to 0.

The preparation of a DS1921H/Z for a mission including the start of the mission requires up to four steps:

Step 1: set the RTC (if it needs to be adjusted)

Step 2: clear the data of the previous mission

Step 3: set the search condition and mission start delay, clear alarm flags

Step 4: set the temperature alarms and write the sample rate to start the mission

STEP 1

Let the actual time be 15:30:00 hours on Monday, the 1st of April in 2002. This results in the following data to be written to the RTC registers:

| | | | | | | | |
|----------|------|------|------|------|------|------|------|
| Address: | 200h | 201h | 202h | 203h | 204h | 205h | 206h |
| Data: | 00h | 30h | 15h | 01h | 81h | 04h | 02h |

With only a single DS1921H/Z connected to the bus master, the communication of step 1 is as follows:

| MASTER MODE | DATA (LSB FIRST) | COMMENTS |
|-------------|------------------|--|
| TX | (Reset) | Reset pulse (480µs to 960µs) |
| RX | (Presence) | Presence pulse |
| TX | CCh | Issue Skip ROM command |
| TX | 0Fh | Issue Write Scratchpad command |
| TX | 00h | TA1, beginning offset = 00h |
| TX | 02h | TA2, address = 0200h |
| TX | <7 data bytes> | Write 7 bytes of data to scratchpad |
| TX | (Reset) | Reset pulse |
| RX | (Presence) | Presence pulse |
| TX | CCh | Issue Skip ROM command |
| TX | AAh | Issue Read Scratchpad command |
| RX | 00h | Read TA1, beginning offset = 00h |
| RX | 02h | Read TA2, address = 0200h |
| RX | 06h | Read E/S, ending offset = 6h, flags = 0h |
| RX | <7 data bytes> | Read scratchpad data and verify |
| TX | (Reset) | Reset pulse |
| RX | (Presence) | Presence pulse |
| TX | CCh | Issue Skip ROM command |
| TX | 55h | Issue Copy Scratchpad command |
| TX | 00h | TA1 |
| TX | 02h | TA2 (AUTHORIZATION CODE) |
| TX | 06h | E/S |
| TX | (Reset) | Reset pulse |
| RX | (Presence) | Presence pulse |

STEP 2

Set the EMCLR bit to 1, enable the RTC and then execute the Clear Memory command. The RTC oscillator must be stable before the Clear Memory command is issued. Wait 500 μ s after issuing the Clear Memory command before proceeding to Step 3. This results in the following data to be written to the Status Register:

| | |
|----------|------|
| Address: | 20Eh |
| Data: | 40h |

With only a single DS1921H/Z connected to the bus master, the communication of step 2 is as follows:

| MASTER MODE | DATA (LSB FIRST) | COMMENTS |
|-------------|------------------|---|
| TX | (Reset) | Reset pulse (480 μ s to 960 μ s) |
| RX | (Presence) | Presence pulse |
| TX | CCh | Issue Skip ROM command |
| TX | 0Fh | Issue Write Scratchpad command |
| TX | 0Eh | TA1, beginning offset = 0Eh |
| TX | 02h | TA2, address = 020Eh |
| TX | 40h | Write status byte to scratchpad |
| TX | (Reset) | Reset pulse |
| RX | (Presence) | Presence pulse |
| TX | CCh | Issue Skip ROM command |
| TX | AAh | Issue Read Scratchpad command |
| RX | 0Eh | Read TA1, beginning offset = 0Eh |
| RX | 02h | Read TA2, address = 020Eh |
| RX | 0Eh | Read E/S, ending offset = 0Eh, flags = 0h |
| RX | 40h | Read scratchpad data and verify |
| TX | (Reset) | Reset pulse |
| RX | (Presence) | Presence pulse |
| TX | CCh | Issue Skip ROM command |
| TX | 55h | Issue Copy Scratchpad command |
| TX | 0Eh | TA1 |
| TX | 02h | TA2 (AUTHORIZATION CODE) |
| TX | 0Eh | E/S |
| TX | (Reset) | Reset pulse |
| RX | (Presence) | Presence pulse |
| TX | CCh | Issue Skip ROM command |
| TX | 3Ch | Issue Clear Memory command |
| TX | (Reset) | Reset pulse |
| RX | (Presence) | Presence pulse |

STEP 3

In this example, the rollover is disabled and the search condition is set for a high temperature only. The mission is to start with a delay of 90 (005Ah) minutes and the alarm flags TLF, THF, and TAF are cleared. This results in the following data to be written to the special function registers:

| | | | | | | | |
|----------|------|------|------|------|------|------|------|
| Address: | 20Eh | 20Fh | 210h | 211h | 212h | 213h | 214h |
| Data: | 02h | 00h* | 00h* | 00h* | 5Ah | 00h | 00h |

* Writing through address locations 20Fh to 211h is faster than accessing the Mission Start Delay Register in a separate cycle. The write attempt has no effect on the contents of these registers.

With only a single DS1921H/Z connected to the bus master, the communication of step 3 is as follows:

| MASTER MODE | DATA (LSB FIRST) | COMMENTS |
|-------------|------------------|---|
| TX | (Reset) | Reset pulse (480µs to 960µs) |
| RX | (Presence) | Presence pulse |
| TX | CCh | Issue Skip ROM command |
| TX | 0Fh | Issue Write Scratchpad command |
| TX | 0Eh | TA1, beginning offset = 0Eh |
| TX | 02h | TA2, address = 020Eh |
| TX | <7 data bytes> | Write 7 bytes of data to scratchpad |
| TX | (Reset) | Reset pulse |
| RX | (Presence) | Presence pulse |
| TX | CCh | Issue Skip ROM command |
| TX | AAh | Issue Read Scratchpad command |
| RX | 0Eh | Read TA1, beginning offset = 0Eh |
| RX | 02h | Read TA2, address = 020Eh |
| RX | 14h | Read E/S, ending offset = 14h, flags = 0h |
| RX | <7 data bytes> | Read scratchpad data and verify |
| TX | (Reset) | Reset pulse |
| RX | (Presence) | Presence pulse |
| TX | CCh | Issue Skip ROM command |
| TX | 55h | Issue Copy Scratchpad command |
| TX | 0Eh | TA1 |
| TX | 02h | TA2 (AUTHORIZATION CODE) |
| TX | 13h | E/S |
| TX | (Reset) | Reset pulse |
| RX | (Presence) | Presence pulse |

STEP 4

In this example, the temperature alarms are set to 0°C for the low temperature threshold and 10°C for the high temperature threshold, assuming it is a DS1921Z device. The sample rate is once every 10 minutes, allowing the mission to last up to 14 days. This results in the following data to be written to the special function registers:

| | | | |
|----------|------|------|------|
| Address: | 20Bh | 20Ch | 20Dh |
| Data: | 2Ch | 7Ch | 0Ah |

With only a single DS1921H/Z connected to the bus master, the communication of step 4 is as follows:

| MASTER MODE | DATA (LSB FIRST) | COMMENTS |
|-------------|------------------|---|
| TX | (Reset) | Reset pulse (480µs to 960µs) |
| RX | (Presence) | Presence pulse |
| TX | CCh | Issue Skip ROM command |
| TX | 0Fh | Issue Write Scratchpad command |
| TX | 0Bh | TA1, beginning offset = 0Bh |
| TX | 02h | TA2, address = 020Bh |
| TX | <3 data bytes> | Write 3 bytes of data to scratchpad |
| TX | (Reset) | Reset pulse |
| RX | (Presence) | Presence pulse |
| TX | CCh | Issue Skip ROM command |
| TX | AAh | Issue Read Scratchpad command |
| RX | 0Bh | Read TA1, beginning offset = 0Bh |
| RX | 02h | Read TA2, address = 020Bh |
| RX | 0Dh | Read E/S, ending offset = 0Dh, flags = 0h |
| RX | <3 data bytes> | Read scratchpad data and verify |
| TX | (Reset) | Reset pulse |
| RX | (Presence) | Presence pulse |
| TX | CCh | Issue Skip ROM command |
| TX | 55h | Issue Copy Scratchpad command |
| TX | 0Bh | TA1 |
| TX | 02h | TA2 (AUTHORIZATION CODE) |
| TX | 0Dh | E/S |
| TX | (Reset) | Reset pulse |
| RX | (Presence) | Presence pulse |

If step 4 was successful, the MIP bit in the Status Register will be 1, the MEMCLR bit will be 0, and the mission start delay will be counting down.

PHYSICAL SPECIFICATION

| | |
|--------|------------------------|
| Size | See mechanical drawing |
| Weight | 3.3g |

ABSOLUTE MAXIMUM RATINGS*

| | |
|------------------------------------|------------------|
| IO Voltage to GND | -0.5V, +6V |
| IO Sink Current | 20mA |
| Temperature Range DS1921H, DS1921Z | -40°C to +85°C** |
| Storage Temperature Range | -40°C to +50°C** |

* This is a stress rating only and functional operation of the device at these or any other conditions above those indicated in the operation sections of this specification is not implied. Exposure to absolute maximum rating conditions for extended periods of time may affect reliability.

** Storage or operation above 50°C significantly reduces battery life.

ELECTRICAL CHARACTERISTICS ($V_{PUP} = 2.8V$ to $5.25V$, $T_A = -40^\circ C$ to $+85^\circ C$)

| PARAMETER | SYMBOL | CONDITIONS | MIN | TYP | MAX | UNITS | NOTES |
|--|------------|---|------|-----|------|------------|-------------|
| IO pin general data | | | | | | | |
| 1-Wire Pull-Up Resistance | R_{PUP} | | | | 2.2 | k Ω | 1, 2 |
| Input Capacitance | C_{IO} | | | 100 | 800 | pF | 3, 16 |
| Input Load Current | I_L | IO pin at V_{PUP} | | | 10 | μA | 4 |
| High-to-Low Switching Threshold | V_{TL} | $V_{PUP} > 4.5V$ | 1.14 | | 2.70 | V | 5, 6, 7, 16 |
| | | | 0.71 | | 2.70 | | |
| Input Low Voltage | V_{IL} | | | | 0.30 | V | 1, 5, 8 |
| Low-to-High Switching Threshold | V_{TH} | $V_{PUP} > 4.5V$ | 1.00 | | 2.70 | V | 5, 6, 9, 16 |
| | | | 0.66 | | 2.70 | | |
| Output low voltage at 4mA | V_{OL} | | | | 0.4 | V | 5, 10 |
| Recovery Time | t_{REC} | Standard Speed, $R_{PUP} = 2.2k\Omega$ | 5 | | | μs | 1, 16 |
| | | Overdrive Speed, $R_{PUP} = 2.2k\Omega$ | 2 | | | | |
| | | Overdrive Speed, directly prior to reset pulse; $R_{PUP} = 2.2k\Omega$ | 5 | | | | |
| Timeslot Duration | t_{SLOT} | Standard Speed | 65 | | | μs | 1, 15 |
| | | Overdrive Speed | 8 | | | | |
| IO pin, 1-Wire Reset, Presence Detect Cycle | | | | | | | |
| Reset Low Time | t_{RSTL} | Standard Speed, $V_{PUP} > 4.5V$ | 480 | | 640 | μs | 1, 15 |
| | | Standard Speed | 540 | | 640 | | |
| | | Overdrive Speed | 48 | | 80 | | |

| PARAMETER | SYMBOL | CONDITIONS | MIN | TYP | MAX | UNITS | NOTES |
|--------------------------------|----------------|-----------------|-----------------------|-----|---------------|---------------|-----------|
| Presence Detect High Time | t_{PDH} | Standard Speed | 15 | | 60 | μs | 15 |
| | | Overdrive Speed | 1.1 | | 6 | | |
| Presence Detect Low Time | t_{PDL} | Standard Speed | 60 | | 270 | μs | 15 |
| | | Overdrive Speed | 7.5 | | 24 | | |
| Presence Detect Sample Time | t_{MSP} | Standard Speed | 60 | | 75 | μs | 1, 16 |
| | | Overdrive Speed | 6 | | 8.6 | | |
| IO pin, 1-Wire Write | | | | | | | |
| Write-0 Low Time | t_{W0L} | Standard Speed | 60 | | 120 | μs | 1, 11, 15 |
| | | Overdrive Speed | 6 | | 15 | | |
| Write-1 Low Time | t_{W1L} | Standard Speed | 5 | | 15 | μs | 1, 11 |
| | | Overdrive Speed | 1 | | 2 | | |
| IO pin, 1-Wire Read | | | | | | | |
| Read Low Time | t_{RL} | Standard Speed | 5 | | $15 - \delta$ | μs | 1, 12 |
| | | Overdrive Speed | 1 | | $2 - \delta$ | | |
| Read Sample Time | t_{MSR} | Standard Speed | $t_{RL} + \delta$ | | 15 | μs | 1, 12 |
| | | Overdrive Speed | $t_{RL} + \delta$ | | 2 | | |
| Real-Time Clock | | | | | | | |
| Frequency Deviation | Δ_F | -5°C to +46°C | -48 | | +46 | PPM | |
| Temperature Converter | | | | | | | |
| Tempcore Operating Range | T_{TC} | DS1921H | 15 | | 46 | °C | |
| | | DS1921Z | -5 | | +26 | | |
| Conversion Time | t_{CONV} | | 75 | | 360 | ms | |
| Thermal Response Time Constant | τ_{RESP} | | | 130 | | s | 13 |
| Conversion Error | $\Delta\theta$ | | -1 | | +1 | °C | 17, 18 |
| Number of Conversions | N_{CONV} | | (see lifetime graphs) | | | — | 14, 16 |

NOTES

- System Requirement.
- Maximum allowable pull-up resistance is a function of the number of 1-Wire devices in the system and 1-Wire recovery times. The specified value here applies to systems with only one device and with the minimum 1-Wire recovery times. For more heavily loaded systems, an active pull-up such as that found in the DS2480B may be required.
- Capacitance on IO could be 800pF when power is first applied. If a 2.2k Ω resistor is used to pull up the data line, 2.5 μs after V_{PUP} has been applied the parasite capacitor will not affect normal communication.
- Input load is to ground.
- All voltages are referenced to ground.
- V_{TL} and V_{TH} are functions of the internal supply voltage, which is a function of V_{PUP} and the 1-Wire recovery times. The V_{TH} and V_{TL} maximum specifications are valid at $V_{PUP} = 5.25\text{V}$. In any case, $V_{TL} < V_{TH} < V_{PUP}$.
- Voltage below which, during a falling edge on IO, a logic 0 is detected.
- The voltage on IO needs to be less or equal to V_{ILMAX} whenever the master drives the line low.
- Voltage above which, during a rising edge on IO, a logic 1 is detected.
- The I-V characteristic is linear for voltages less than 1V.

- 11) ε in Figure 15 represents the time required for the pull-up circuitry to pull the voltage on IO up from V_{IL} to V_{TH} . The actual maximum duration for the master to pull the line low is $t_{WILMAX} + t_F - \varepsilon$ and $t_{WOLMAX} + t_F - \varepsilon$, respectively.
- 12) δ in Figure 15 represents the time required for the pull-up circuitry to pull the voltage on IO up from V_{IL} to the input high threshold of the bus master. The actual maximum duration for the master to pull the line low is $t_{RLMAX} + t_F$.
- 13) This number was derived from a test conducted by Cemagref in Antony, France, in July of 2000. <http://www.cemagref.fr/English/index.htm> Test Report No. E42
- 14) The number of temperature conversions (= Samples) possible with the built-in energy source depends on the operating and storage temperature of the device. When not in use for a mission, the RTC oscillator should be turned off and device should be stored at a temperature not exceeding +25°C. Under this condition the shelf life time is 10 years minimum.
- 15) Highlighted numbers are not in compliance with the published iButton device standards. See comparison table below.
- 16) These values are derived from simulation across process, voltage, and temperature and are not production tested.
- 17) Total accuracy is $\Delta 9$ plus 1/16°C quantization due to the 1/8°C digital resolution of the device.
- 18) **WARNING:** Maxim data logger products are 100% tested and calibrated at time of manufacture to ensure that they meet all data sheet parameters, including temperature accuracy. As with any sensor-based product, user shall be responsible for occasionally rechecking the temperature accuracy of the product to ensure it is still operating properly. Furthermore, as with all products of this type, when deployed in the field and subjected to handling, harsh environments, or other hazards/use conditions, there may be some extremely small but non-zero logger failure rate. In applications where the failure of any logger is a concern, user shall assure that redundant (or other primary) methods of testing and determining the handling methods, quality, and fitness of the articles and products are implemented to further mitigate any risk.

| Parameter Name | Standard Values | | | | DS1921H/Z Values | | | |
|-------------------------------|-----------------|-------------|-----------------|------------|--------------------------|-------------|-------------------------|------------|
| | Standard Speed | | Overdrive Speed | | Standard Speed | | Overdrive Speed | |
| | min | max | min | max | min | max | min | max |
| t_{SLOT} (incl. t_{REC}) | 61 μ s | (undef.) | 7 μ s | (undef.) | 65 μ s ¹⁾ | (undef.) | 8 μ s ¹⁾ | (undef.) |
| t_{RSTL} | 480 μ s | (undef.) | 48 μ s | 80 μ s | 540 μ s | 640 μ s | 48 μ s | 80 μ s |
| t_{PDH} | 15 μ s | 60 μ s | 2 μ s | 6 μ s | 15 μ s | 60 μ s | 1.1 μ s | 6 μ s |
| t_{PDL} | 60 μ s | 240 μ s | 8 μ s | 24 μ s | 60 μ s | 270 μ s | 7.5 μ s | 24 μ s |
| t_{WOL} | 60 μ s | 120 μ s | 6 μ s | 16 μ s | 60 μ s | 120 μ s | 6 μ s | 15 μ s |

- 1) Intentional change, longer recovery time between time slots.

RTC Frequency Deviation vs Temperature

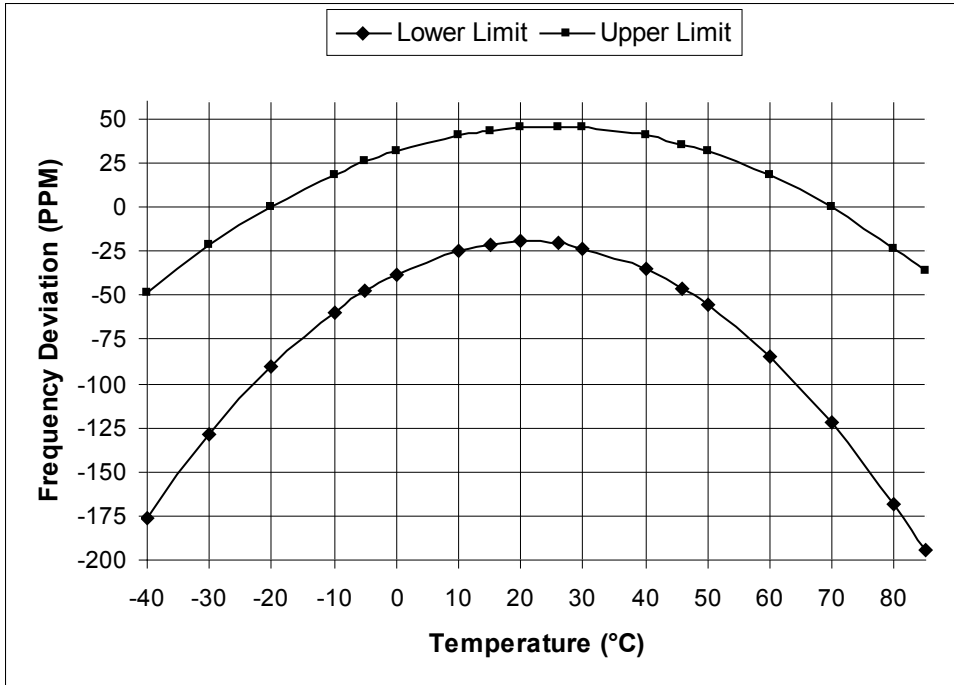

Minimum Product Lifetime vs Temperature at Different Sample Rates

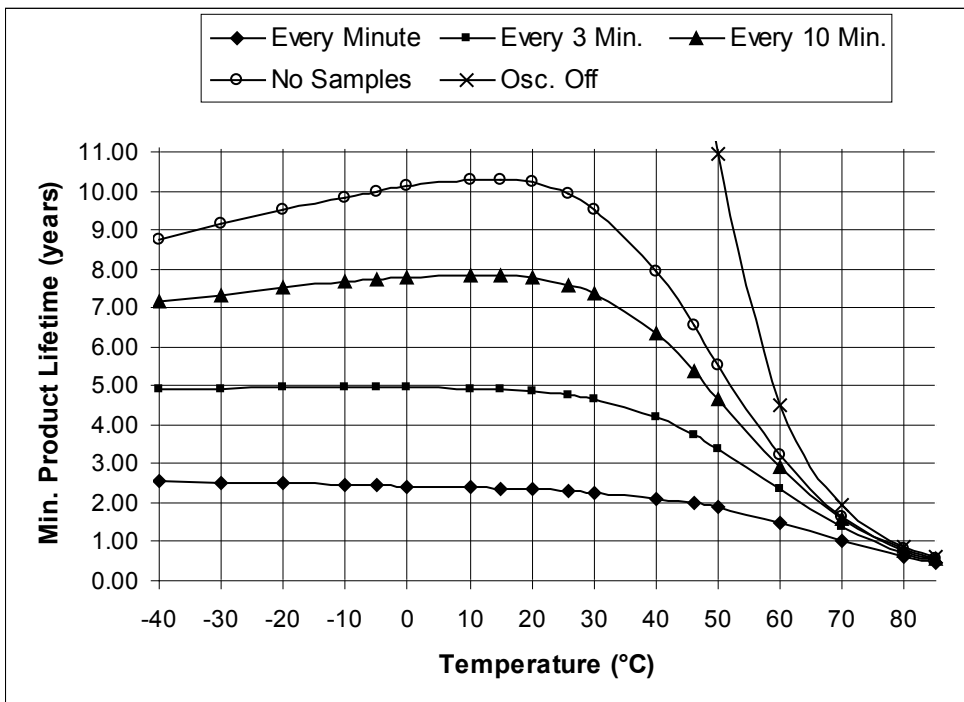

Minimum Product Lifetime vs Sample Rate at Different Temperatures

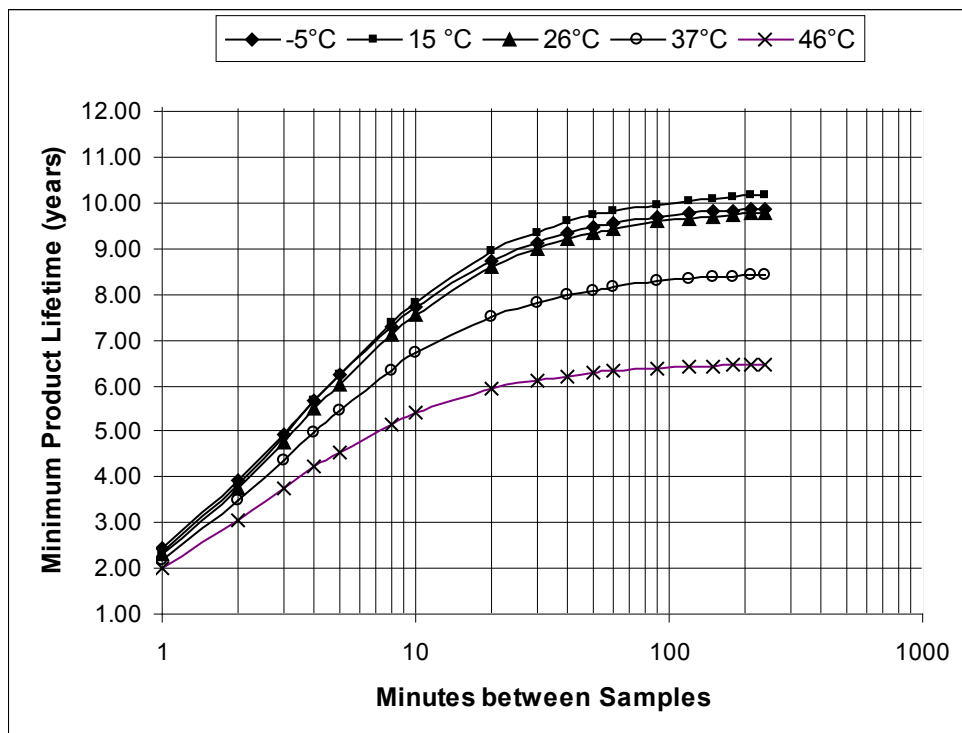

PACKAGE INFORMATION

For the latest package outline information and land patterns (footprints), go to www.maximintegrated.com/packages. Note that a “+”, “#”, or “-” in the package code indicates RoHS status only. Package drawings may show a different suffix character, but the drawing pertains to the package regardless of RoHS status.

| PACKAGE TYPE | PACKAGE CODE | OUTLINE NO. | LAND PATTERN NO. |
|--------------|--------------|-------------------------|------------------|
| F5 Can | IB#5CP | 21-0266 | — |

REVISION HISTORY

| REVISION DATE | DESCRIPTION | PAGES CHANGED |
|----------------------|--|----------------------|
| 020402 | Initial release | — |
| 091202 | Various updates to the <i>Electrical Characteristics</i> table, note 16 added. | 36, 37, 38 |
| 100703 | Branding change from <i>Dallas</i> to <i>iButton</i> , style updates, more detailed register page map, various text updates regarding mission start and 1-Wire communication, added sections <i>Mission Start and Logging Process</i> plus graphic, <i>Memory Access Conflicts</i> and <i>Command-Specific 1-Wire Communication Protocol</i> , note 17 added to <i>Electrical Characteristics</i> table. | various |
| 121003 | Corrected the location of the CENT bit. | 6, 7 |
| 051104 | Added note 18 to <i>Electrical Characteristics</i> table. | 42 |
| 110504 | Extended note 18 of the <i>Electrical Characteristics</i> table. | 42 |
| 082906 | Changed UL text (from “application pending” to “designed to meet...”); deleted row “Safety” from physical specification. | 1 40 |
| 120407 | Added bullet “Water resistant or waterproof if placed inside DS9107 iButton capsule (Exceeds Water Resistant 3 ATM requirements)”. | 1 |
| | Add text to <i>Application</i> section: Note that the initial sealing level of DS1921H/Z achieves IP56. Aging and use conditions can degrade the integrity of the seal over time, so for applications with significant exposure to liquids, sprays, or other similar environments, it is recommended to place the Thermochron in the DS9107 iButton capsule. The DS9107 provides a watertight enclosure that has been rated to IP68 (See www.maxim-ic.com/AN4126). | 2 |
| 8/09 | Added the # sign to the Part Numbers in the <i>Ordering Information</i> table, indicating RoHS-compliant packages. | 1 |
| | Removed the UL#913 bullet from the <i>Common iButton Features</i> section. | 1 |
| 12/11 | Marking updated for RoHS. | 1 |
| | Revised the last sentence of the Parasite Power section for more clarity. | 3 |
| | In the <i>Electrical Characteristics</i> table, deleted ϵ from the t_{W1L} specification, applied Note 11 to the t_{W0L} specification, added more details notes 6, 11 and 12. | 41, 42 |
| | Added the <i>Package Information</i> section and completed the <i>Revision History</i> . | 44, 45 |
| 3/12 | Added terminology updates for consistency with similar products. | 1, 2, 5, 9 |
| | Added more details to the <i>Parasite Power</i> section. | 3 |
| 6/13 | Reworded the <i>Electrical Characteristics</i> table Note 18. | 42 |
| 11/13 | Added the Busy state during Copy Scratchpad to the <i>Command-Specific 1-Wire Communication Protocol—Legend</i> and examples sections | 33, 34 |

X-ON Electronics

Largest Supplier of Electrical and Electronic Components

Click to view similar products for [iButtons & Accessories](#) category:

Click to view products by [Maxim](#) manufacturer:

Other Similar products are found below :

[DS9094F+](#) [DS9092+](#) [DS9092L+](#) [DS9093A+](#) [DS9093AB+](#) [DS9093AG+](#) [DS9093AY+](#) [DS9093S+](#) [DS9094FS+](#) [DS9098P-TRL+](#) [DS9100-](#)
[B+](#) [DS9100-C+](#) [DS9106L-0G0+](#) [DS9106L-GN0](#) [DS9093AR+](#) [DS9105-00C#](#)