

Electronically Programmable Voltage Reference

General Description

The DS4305 is a nonvolatile (NV) electronically programmable voltage reference. The reference voltage is programmed in-circuit during factory calibration/programming. Programming the reference voltage, V_{OUT} , is as simple as applying the desired voltage on V_{IN} and toggling the adjust pin (\overline{ADJ}) to lock the V_{OUT} voltage level indefinitely, even if the device is power cycled. The DS4305 replaces current cumbersome factory adjustment arrangements with a low-cost solution that can be adjusted using automated techniques. In addition, the DS4305 has the ability to be readjusted after the unit has been fully assembled and tested. This results in a much more flexible manufacturing arrangement, lower inventory costs, and a quicker time-to-market.

Applications

Power-Supply Calibration
Threshold Setting
Offset Nulling
Bias Adjusting
Power Amps
Pressure Bridges
Factory-Calibrated Equipment

Typical Operating Circuit

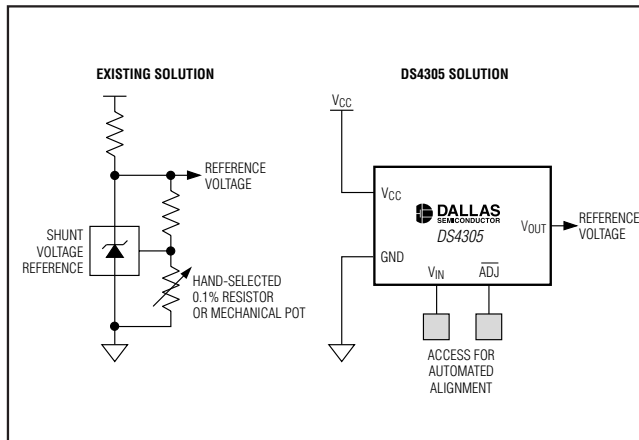

Features

- ◆ Precise Electronically Adjustable Voltage Reference
- ◆ Enables Automated Factory Trimming of Devices Needing Voltage Adjustment
- ◆ Can be Adjusted to Within $\pm 1.5\text{mV}$
- ◆ Wide Adjustable Output Voltage Range Within 300mV of the Supply Rails
- ◆ Low Temperature Coefficient
- ◆ $\pm 1\text{mA}$ of Output-Current Drive
- ◆ NV Memory Stores the Voltage Indefinitely
- ◆ Output Short-Circuit Protection
- ◆ Low Cost
- ◆ Low Power Consumption
- ◆ 4.0V to 5.5V Single-Supply Operation
- ◆ Small 5-Lead SOT23 Package
- ◆ -40°C to $+125^\circ\text{C}$ Temperature Operation
- ◆ DS4305K Evaluation Kit is Available

Ordering Information

| PART | TEMP RANGE | PIN-PACKAGE | SOT MARK |
|-------------|---|-------------|----------|
| DS4305R+T&R | -40°C to $+125^\circ\text{C}$ | 5 SOT23 | 4305+ |

+Denotes lead-free package.

Pin Configuration

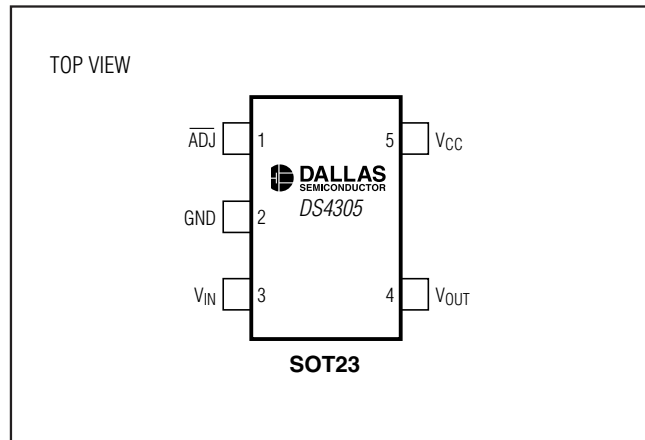

Electronically Programmable Voltage Reference

ABSOLUTE MAXIMUM RATINGS

Voltage on V_{CC} Relative to GND-0.5V to +6.0V
 Voltage on V_{IN} , \overline{ADJ} , and V_{OUT}
 Relative to GND ...-0.5V to ($V_{CC} + 0.5V$), not to exceed +6.0V
 Operating Temperature Range-40°C to +125°C

EEPROM Programming Adjust Temperature.....0°C to +70°C
 V_{OUT} to GND Short-Circuit DurationContinuous
 Storage Temperature Range-55°C to +125°C
 Soldering Temperature ...See IPC/JEDEC J-STD-020 Specification

Stresses beyond those listed under "Absolute Maximum Ratings" may cause permanent damage to the device. These are stress ratings only, and functional operation of the device at these or any other conditions beyond those indicated in the operational sections of the specifications is not implied. Exposure to absolute maximum rating conditions for extended periods may affect device reliability.

RECOMMENDED OPERATING CONDITIONS

($T_A = -40^\circ\text{C}$ to $+125^\circ\text{C}$)

| PARAMETER | SYMBOL | CONDITIONS | MIN | TYP | MAX | UNITS |
|--------------------------|------------|------------|------|---------------------|-----|-------|
| Supply Voltage | V_{CC} | (Note 1) | 4.0 | | 5.5 | V |
| V_{IN} Voltage Range | V_{IN} | | 0.3 | $V_{CC} - 0.3$ | | V |
| \overline{ADJ} Logic 0 | V_{IL} | | -0.3 | $0.3 \times V_{CC}$ | | V |
| V_{OUT} Current | V_{OUTI} | | -1 | | +1 | mA |
| V_{OUT} Load | V_{OUTL} | | | | 100 | pF |

ELECTRICAL CHARACTERISTICS

($V_{CC} = +4.0V$ to $+5.5V$, $T_A = -40^\circ\text{C}$ to $+125^\circ\text{C}$, unless otherwise noted.)

| PARAMETER | SYMBOL | CONDITIONS | MIN | TYP | MAX | UNITS |
|------------------------------------|----------------|--|------|----------|----------------|-----------------------|
| Supply Current | I_{IN} | -40°C to +85°C; V_{IN} , \overline{ADJ} , and $V_{OUT} = \text{open circuit}$ | | 1.4 | 2.0 | mA |
| | | +85°C to +125°C; V_{IN} , \overline{ADJ} , and $V_{OUT} = \text{open circuit}$ | | | 2.1 | |
| V_{IN} Resistance | R_{PD} | | 95 | | | k Ω |
| \overline{ADJ} Pullup Resistance | R_{PU} | | 18 | | | k Ω |
| V_{OUT} Voltage Range | V_{OUTR} | (Note 1) | 0.3 | | $V_{CC} - 0.3$ | V |
| V_{OUT} Tracking Accuracy | V_{OUTTA} | (Note 2) | | | ± 20 | mV |
| V_{OUT} Quantization | V_{OUTQ} | (Note 3) | | | ± 1.5 | mV |
| V_{OUT} Temperature Coefficient | $V_{OUT\ TC}$ | -40°C to +85°C, $V_{OUT} = 0.7V$ | | ± 56 | | ppm/ $^\circ\text{C}$ |
| | | -40°C to +25°C, $V_{OUT} = 5.0V$, $V_{CC} \geq 5.3V$ | 7 | 34 | 60 | |
| | | +25°C to +85°C, $V_{OUT} = 5.0V$, $V_{CC} \geq 5.3V$ | -24 | -7 | +10 | |
| | | +85°C to +125°C, $V_{OUT} = 5.0V$, $V_{CC} \geq 5.3V$ | -43 | -23 | -3 | |
| V_{OUT} Line Regulation | $V_{OUT\ LN}$ | -40°C to +85°C | -1.6 | | +1.8 | mV/V |
| | | +85°C to +125°C | -1.6 | | +1.8 | |
| V_{OUT} Load Regulation | $V_{OUT\ LD}$ | -40°C to +85°C, $-1\text{mA} \leq V_{OUT\ I} \leq +1\text{mA}$ | | | 2.0 | mV/mA |
| | | +85°C to +125°C, $-1.0\text{mA} \leq V_{OUT\ I} \leq +1.0\text{mA}$ | | | 2.5 | |
| Long-Term Stability | $V_{OUT\ LTS}$ | 1000 hours at +25°C | | | | ppm |
| V_{OUT} Noise | e_{n1} | $0.1\text{Hz} \leq f \leq 10\text{Hz}$ | | 160 | | μV_{P-P} |
| | e_{n2} | $10\text{Hz} \leq f \leq 1\text{kHz}$ | | 23 | | μV_{RMS} |

Electronically Programmable Voltage Reference

ELECTRICAL CHARACTERISTICS (continued)

($V_{CC} = +4.0V$ to $+5.5V$, $T_A = -40^{\circ}C$ to $+125^{\circ}C$, unless otherwise noted.)

| PARAMETER | SYMBOL | CONDITIONS | MIN | TYP | MAX | UNITS |
|-------------------------------------|---------------|---|-----|------|-----|---------|
| V_{OUT} PSRR | $V_{OUTPSRR}$ | $f = 200kHz$ | | 28 | | dB |
| V_{OUT} Self-Adjust Settling Time | t_{ST} | (Note 4) | | 7 | 10 | ms/V |
| EEPROM Programming Time | t_W | (Note 5) | | 9 | 12 | ms |
| Turn-On Time | t_{ON} | V_{IN} and $\overline{ADJ} =$ open circuit (Note 6) | | | 10 | μs |
| \overline{ADJ} Toggle Low Time | t_{ADJ} | | 100 | | | ns |
| V_{OUT} Factory-Trimmed Value | V_{OUTFT} | $+25^{\circ}C$, $V_{CC} = 5.8V$ (Note 7) | | 1200 | | mV |

NONVOLATILE MEMORY CHARACTERISTICS

($V_{CC} = +4.0V$ to $5.5V$, unless otherwise noted.)

| PARAMETER | SYMBOL | CONDITIONS | MIN | TYP | MAX | UNITS |
|--------------------|--------|-------------------------|--------|-----|-----|--------|
| Programming Cycles | | $+70^{\circ}C$ (Note 8) | 50,000 | | | Cycles |

Note 1: All voltages referenced to ground.

Note 2: Tracking accuracy is defined as $V_{OUT} - V_{IN}$ after the DS4305 has completed self-adjustment.

Note 3: Quantization refers to the size of the voltage steps used to track the input signal.

Note 4: Settling time is the maximum amount of time V_{OUT} requires to self-adjust. The settling time is determined by the following formula: $\Delta V_{OUT} \times t_{ST}$.

Note 5: EEPROM programming time is the hold time required after the DS4305 has completed self-adjustment before V_{IN} or V_{CC} can be removed or before \overline{ADJ} can be toggled low once again.

Note 6: Turn-on time is defined as the time required for V_{OUT} to reach its specified accuracy after the required supply voltage is applied.

Note 7: V_{OUT} not loaded.

Note 8: Guaranteed by design.

Typical Operating Characteristics

($V_{CC} = 5.0V$, $T_A = +25^{\circ}C$, unless otherwise noted.)

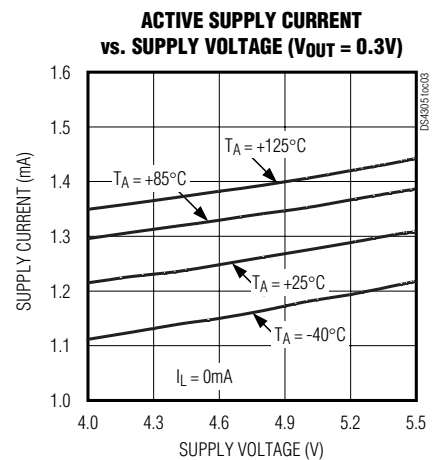
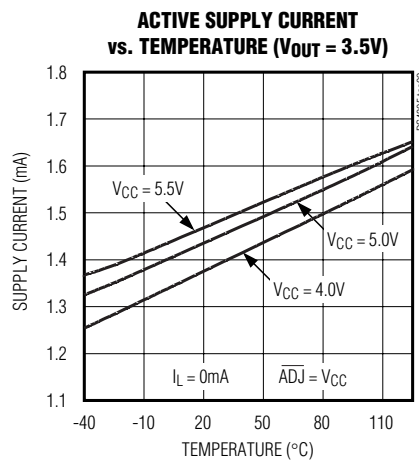
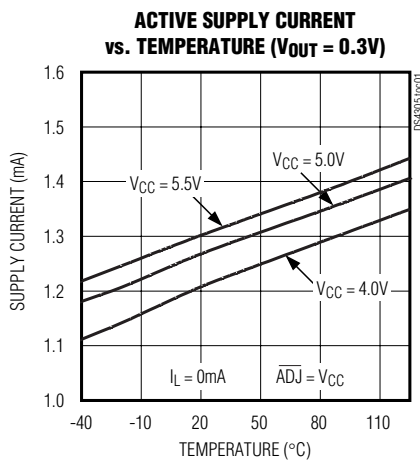

Electronically Programmable Voltage Reference

Typical Operating Characteristics (continued)

($V_{CC} = 5.0V$, $T_A = +25^\circ C$, unless otherwise noted.)

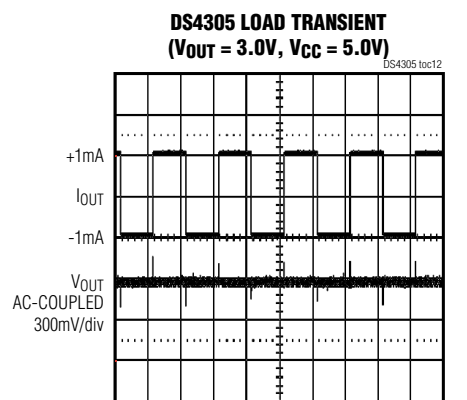
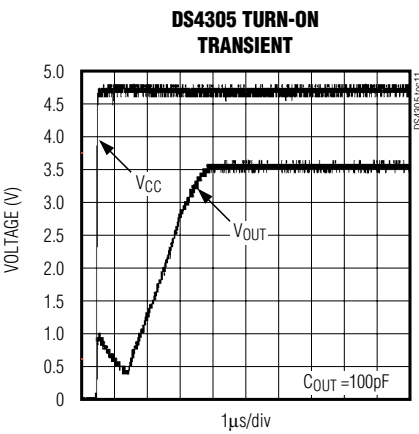
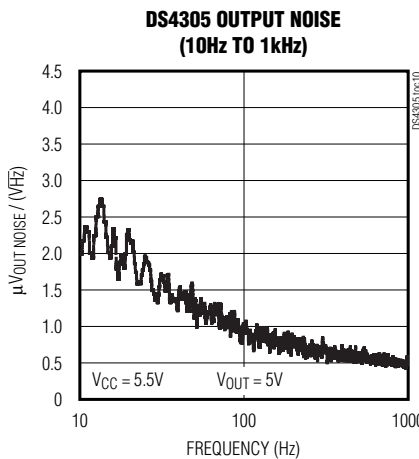
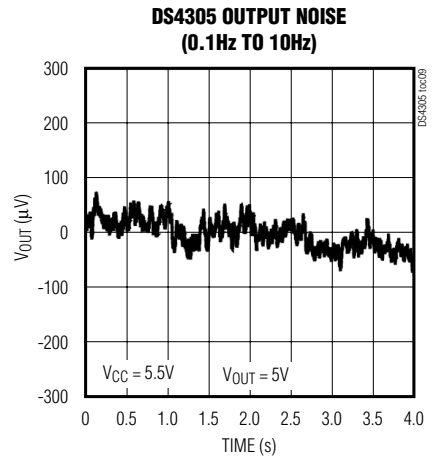
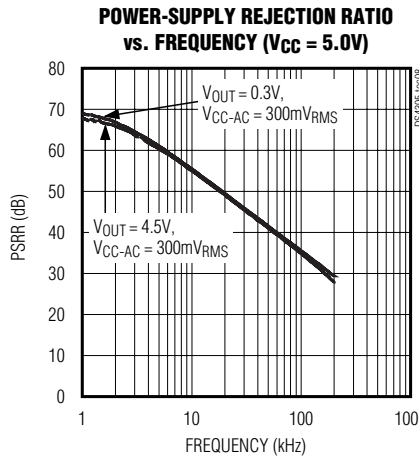
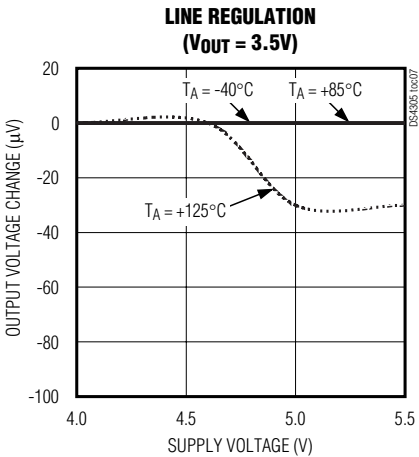
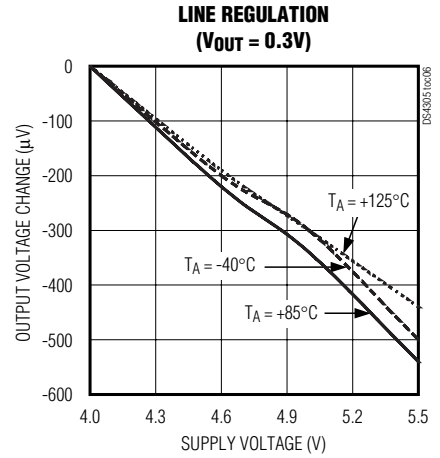
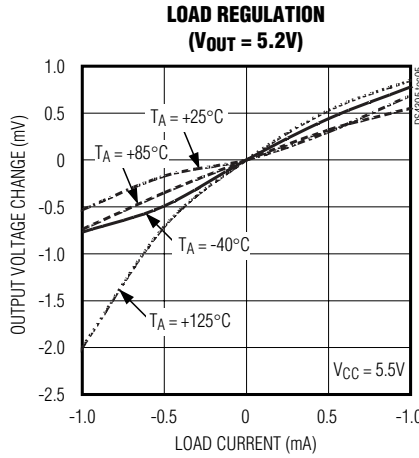
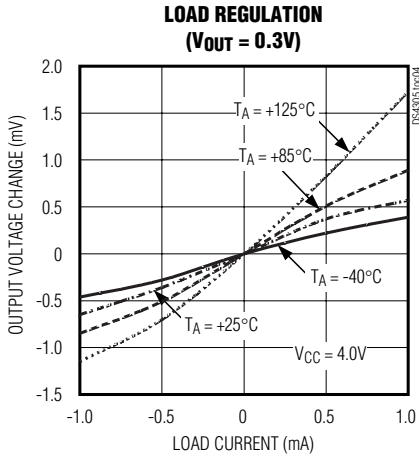

Electronically Programmable Voltage Reference

DS4305

Typical Operating Characteristics (continued)

($V_{CC} = 5.0V$, $T_A = +25^\circ C$, unless otherwise noted.)

DS4305 LINE TRANSIENT
($V_{OUT} = 3.0V$)

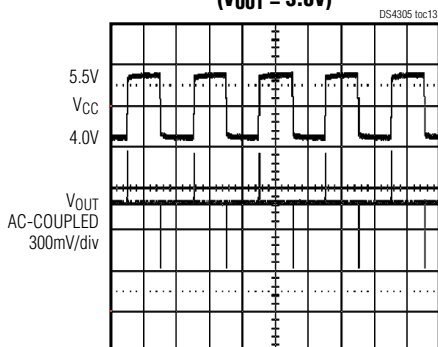

DS4305 SHUTDOWN TRANSIENT
($V_{OUT} = 4.0V$)

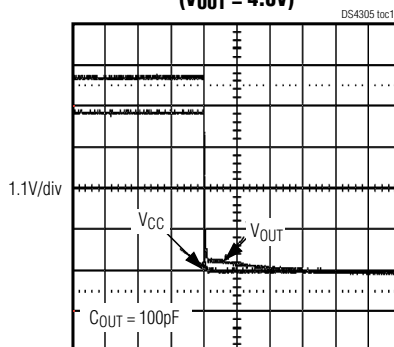

DS4305 V_{OUT} ADJUST TRANSIENT
($V_{IN} = 0.3V$ TO $4.0V$, $V_{CC} = 5.0V$)

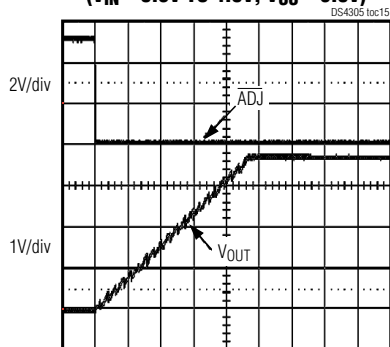

DS4305 NORMALIZED V_{OUT} vs. TEMPERATURE ($V_{OUT} = 0.7V$)

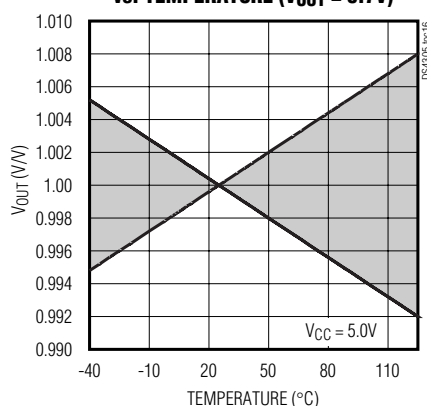

DS4305 NORMALIZED V_{OUT} vs. TEMPERATURE ($V_{OUT} = 5.0V$)

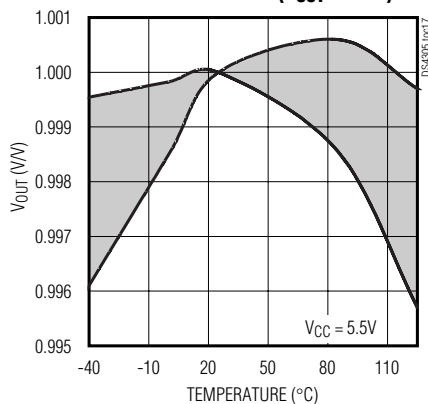

Electronically Programmable Voltage Reference

Pin Description

| PIN | NAME | FUNCTION |
|-----|-------------------------|----------------------|
| 1 | $\overline{\text{ADJ}}$ | Adjust Control Input |
| 2 | GND | Ground |
| 3 | V_{IN} | Sample Voltage Input |
| 4 | V_{OUT} | Voltage Output |
| 5 | V_{CC} | Power-Supply Voltage |

Block Diagram

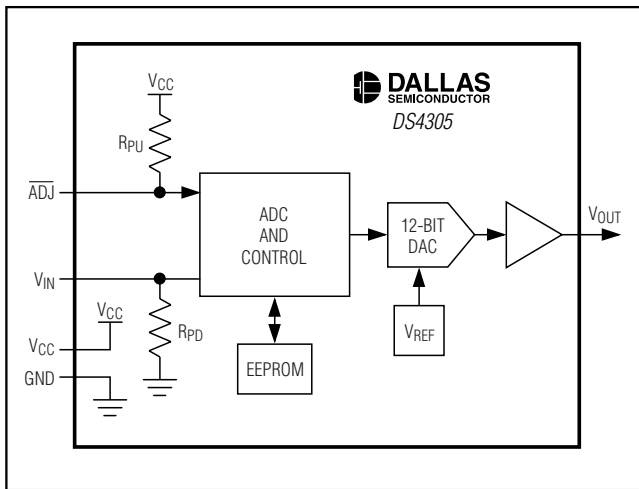

Detailed Description

The DS4305 provides a precise, NV output voltage, V_{OUT} , making it an ideal solution for factory calibration of embedded systems. The DS4305 output voltage can be adjusted over almost the entire operating supply range of the device, and it can be precisely set to within $\pm 1.5\text{mV}$. A graphical description of the DS4305 is provided in the block diagram.

During factory calibration, a simple adjustment procedure must be followed. This entire procedure includes setting V_{IN} , toggling $\overline{\text{ADJ}}$, waiting as V_{OUT} self-adjusts, and waiting for the completion of the EEPROM storage cycle (see the timing diagram in Figure 1). At the start of calibration, a voltage must be placed on V_{IN} . This voltage needs to be completely stable before the adjustment procedure begins, and it must remain stable throughout the entire adjustment procedure. The DS4305 starts its self-adjust procedure when the $\overline{\text{ADJ}}$ pin is pulled low and held low for at least t_{ADJ} , after which it can be released at any time. Once $\overline{\text{ADJ}}$ has been released, it should not be toggled again for the remainder of the adjustment procedure. After the falling edge on $\overline{\text{ADJ}}$ and the wait time, t_{ADJ} , the V_{OUT} self-adjust period begins. The length of the V_{OUT} self-adjust period can be determined using the formula $\Delta V \times t_{\text{ST}}$, where ΔV is $|V_{\text{OUT OLD}} - V_{\text{OUT NEW}}|$.

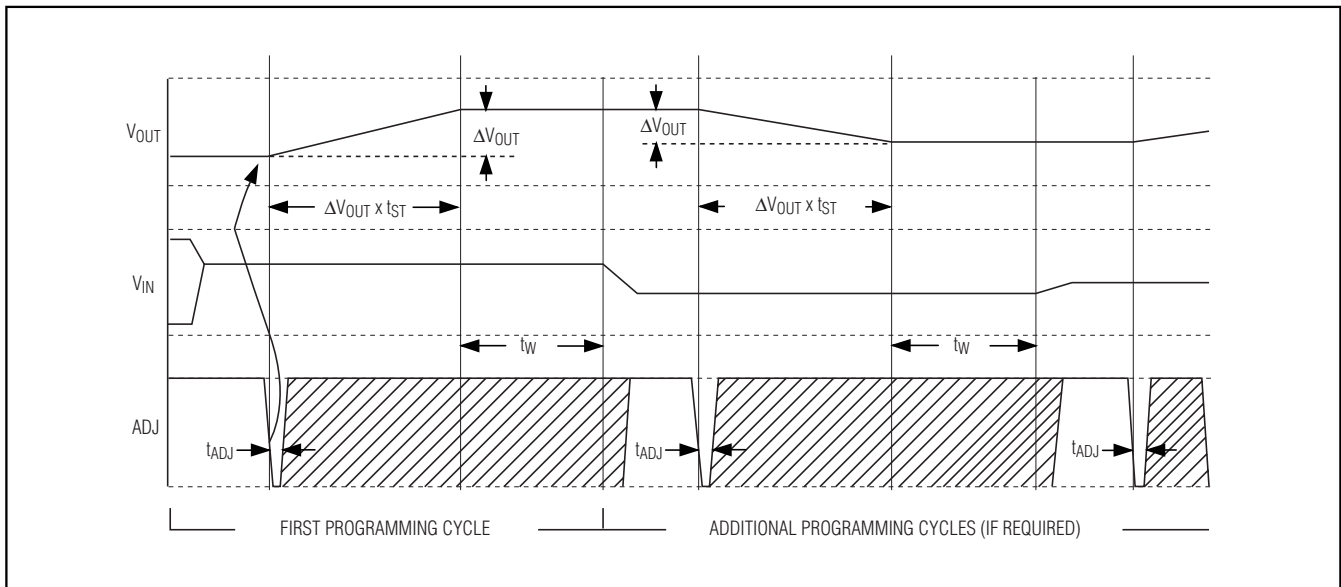

Figure 1. Timing Diagram

Electronically Programmable Voltage Reference

DS4305

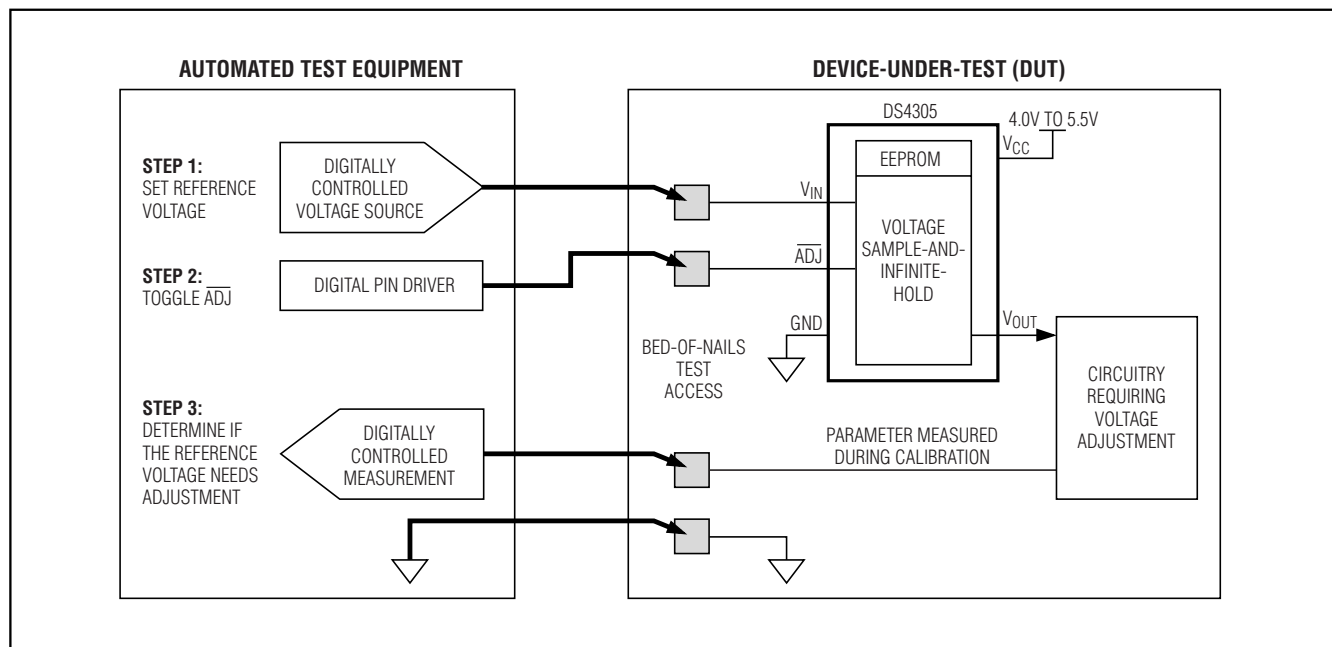

Figure 2. Application Circuit

During the V_{OUT} self-adjust period, the DS4305 internally adjusts the on-board DAC until V_{OUT} matches V_{IN} . After V_{OUT} has stabilized to within the tracking accuracy, V_{OUTTA} , of V_{IN} , it will be automatically stored in EEPROM. The storage period lasts for the duration of the EEPROM write time, t_{W} . After the first adjustment procedure has completed, V_{OUT} can be measured, and if necessary V_{IN} can be readjusted and the entire adjustment procedure can be repeated to fine-tune V_{OUT} within the V_{OUTQ} range.

Following each self-adjust procedure, V_{OUT} is saved indefinitely, even if the DS4305 is power cycled.

Automated Programming Procedure

Figure 2 details an example of how the DS4305 can be adjusted in an application. During factory alignment, a three/four-node bed-of-nails is used to: (1) provide the adjustment voltage through the V_{IN} pin, (2) control the \overline{ADJ} input, and (3) sense the needed feedback parameter. During manufacture, an automated test procedure adjusts V_{OUT} , by changing V_{IN} , until the feedback parameter is optimized. After the bed-of-nails operation is complete, both the V_{IN} and \overline{ADJ} inputs are left open

circuit. V_{OUT} can be readjusted at any time by following the same procedure. The closed-loop nature of the adjustment process removes all the system inaccuracies such as resistor tolerances, amplifier offsets, gain mismatches, and even the inaccuracies in the automated equipment that provides the reference voltage.

Typical Operating Circuit

The *Typical Operating Circuit* shows an example of how the DS4305 can replace most existing calibration solutions. Many power supplies use a shunt voltage reference to provide the internal reference voltage, and fine-tune adjustments are often made with hand-selected discrete resistors. The DS4305 replaces this cumbersome arrangement with a solution that is capable of being adjusted by automated techniques. An additional benefit of the DS4305 is the ability to provide a much lower voltage (down to 300mV) than is possible with shunt voltage references. Another benefit of the DS4305 is the ability to be adjusted after the unit has been fully assembled and tested, resulting in a much more flexible manufacturing arrangement, lower inventory costs, and a quicker time-to-market.

Electronically Programmable Voltage Reference

Layout Considerations

To prevent an inadvertent programming cycle from occurring during power-up, minimize capacitive loading on the $\overline{\text{ADJ}}$ pin. A large capacitance on this pin could potentially hold $\overline{\text{ADJ}}$ in a low state long enough that a programming cycle is initiated.

Power-Supply Decoupling

To achieve best results, it is highly recommended that a decoupling capacitor is used on the IC power-supply pin. Typical values of decoupling capacitors are 0.01 μF or 0.1 μF . Use a high-quality, ceramic, surface-mount capacitor, and mount it as close as possible to the VCC and GND pins of the IC to minimize lead inductance.

Chip Topology

TRANSISTOR COUNT: 6016

SUBSTRATE CONNECTED TO GROUND

Package Information

For the latest package outline information, go to www.maxim-ic.com/DallasPackInfo.

Revision History

Pages changed at Rev1: 1

Title changes—all pages

Maxim cannot assume responsibility for use of any circuitry other than circuitry entirely embodied in a Maxim product. No circuit patent licenses are implied. Maxim reserves the right to change the circuitry and specifications without notice at any time.

8 **Maxim Integrated Products, 120 San Gabriel Drive, Sunnyvale, CA 94086 408-737-7600**

© 2006 Maxim Integrated Products

MAXIM is a registered trademark of Maxim Integrated Products, Inc.



is a registered trademark of Dallas Semiconductor Corporation.

X-ON Electronics

Largest Supplier of Electrical and Electronic Components

Click to view similar products for [Voltage References](#) category:

Click to view products by [Maxim](#) manufacturer:

Other Similar products are found below :

[REF01J/883](#) [5962-8686103XC](#) [NCV431BVDMR2G](#) [LT6654AMPS6-2.048#TRMPBF](#) [SCV431AIDMR2G](#) [LT1019AIS8-2.5](#)
[LT6654AMPS6-3.3#TRM](#) [SC431ILPRAG](#) [AP432AQG-7](#) [LM4040B25QFTA](#) [NJM2823F-TE1](#) [TL431-A](#) [MCP1502T-18E/CHY](#) [MCP1502T-40E/CHY](#) [TL4050B25QDBZR](#) [TL431ACZ](#) [KA431SLMF2TF](#) [KA431SMF2TF](#) [KA431SMFTF](#) [LM4041C12ILPR](#) [LM4120AIM5-2.5/NOP](#)
[LM431SCCMFX](#) [TS3330AQPR](#) [REF5040MDREP](#) [LM285BXM-1.2/NOPB](#) [LM385BM-2.5/NOPB](#) [LM4040AIM3-10.0](#) [LM4040BIM3-4.1](#)
[LM4040CIM3-10.0](#) [LM4040CIM3X-2.0/NOPB](#) [LM4041BSD-122GT3](#) [LM4041QDIM3-ADJ/NO](#) [LM4050QAEM3X4.1/NOPB](#)
[LM4051BIM3-ADJ/NOPB](#) [LM4051CIM3X-1.2/NOPB](#) [LM4128CMF-1.8/NOPB](#) [LM4132DMF-1.8/NOPB](#) [LM4132EMF-1.8/NOPB](#)
[LM4132EMF-2.0/NOPB](#) [LM4140CCMX-1.2/NOPB](#) [LM431CIM](#) [LM385BD-2.5R2G](#) [LM385M-2.5/NOPB](#) [LM4030AMF-4.096/NOPB](#)
[LM4040D30ILPR](#) [LM4051CIM3X-ADJ/NOPB](#) [AP432YG-13](#) [AS431ANTR-G1](#) [AS431BZTR-E1](#) [AN431AN-ATRG1](#)