

MAX11253/MAX11254 Family Evaluation Kit

Evaluates: MAX11253/MAX11254

General Description

The MAX11253/MAX11254 evaluation kit (EV kit) provides a proven design to evaluate the MAX11253/MAX11254 family of 16-bit/24-bit, 6-channel, 64ksps, integrated PGA delta-sigma ADCs. The EV kit includes a graphical user interface (GUI) that provides communication from the target device to the PC. The EV kit can operate in multiple modes:

- 1) **Standalone Mode:** in “standalone” mode, the EV kit is connected to the PC via a USB cable and performs a subset of the complete EV kit functions with limitations for sample rate, sample size, and no support for coherent sampling.
- 2) **FPGA Mode:** in “FPGA” mode, the EV kit is connected to an Avnet ZedBoard™ through a low-pin-count FMC connector. ZedBoard features a Xilinx® Zynq® -7000 SoC, which connects to the PC through an Ethernet port, allowing the GUI to perform different operations with full control over mezzanine card functions. The EV kit with FPGA platform performs the complete suite of evaluation tests for the target IC.
- 3) **User-Supplied SPI Mode:** In addition to the USB and FMC interfaces, the EV kit provides a 12-pin Pmod™-style header for user-supplied SPI interface to connect the signals for SCLK, DIN, DOUT, and CNVST.

The EV kit includes Windows XP®, Windows® 7, and Windows 8.1-compatible software for exercising the features of the IC. The EV kit GUI allows different sample sizes, adjustable sampling rates, internal or external reference options, and graphing software that includes the FFT and histogram of the sampled signals.

The ZedBoard accepts a +12V AC-DC wall adapter. The EV kit can be powered by a local +12V supply. The EV kit has on-board transformers and digital isolators to separate the IC from the ZedBoard/on-board processor.

The MAX11253/MAX11254 EV kit comes installed with a MAX11253ATJ+ or MAX11254ATJ+ in a 32-pin TQFN-EP package.

Features

- High-Speed USB Connector, FMC Connector, and Pmod-Style Connector
- 8MHz SPI Clock Capability through FMC Connector
- 8MHz SPI Clock Capability in Standalone Mode
- Various Sample Sizes and Sample Rates
- Collects Up to 1 Million Samples (with FPGA Platform)
- Time Domain, Frequency Domain, and Histogram Plotting
- Sync In and Sync Out for Coherent Sampling (with FPGA Platform)
- On-Board Input Buffers: MAX9632 and MAX44205 (Fully Differential)
- On-Board Voltage References (MAX6126 and MAX6070)
- Proven PCB Layout
- Fully Assembled and Tested
- Windows XP-, Windows 7-, and Windows 8.1-Compatible Software

Ordering Information appears at end of data sheet.

Pmod is a trademark of Digilent Inc.

ZedBoard is a trademark of Avnet, Inc.

Xilinx and Zynq are registered trademarks and Xilinx is a registered service mark of Xilinx, Inc.

Windows and Windows XP are registered trademarks and registered service marks of Microsoft Corporation.



MAX11253/MAX11254 Family Evaluation Kit

Evaluates: MAX11253/MAX11254

MAX11253/11254 EV Kit Photo

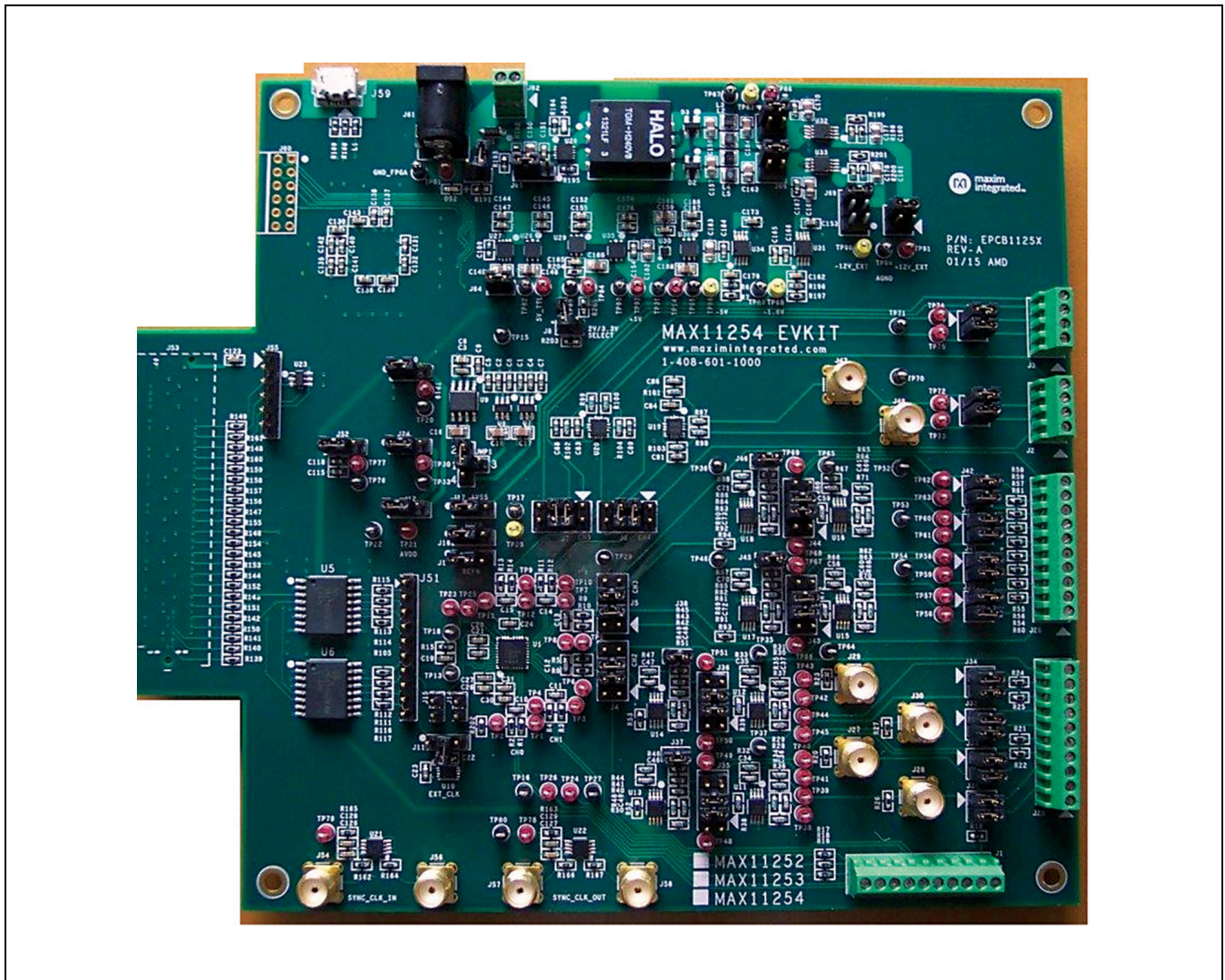

System Block Diagram

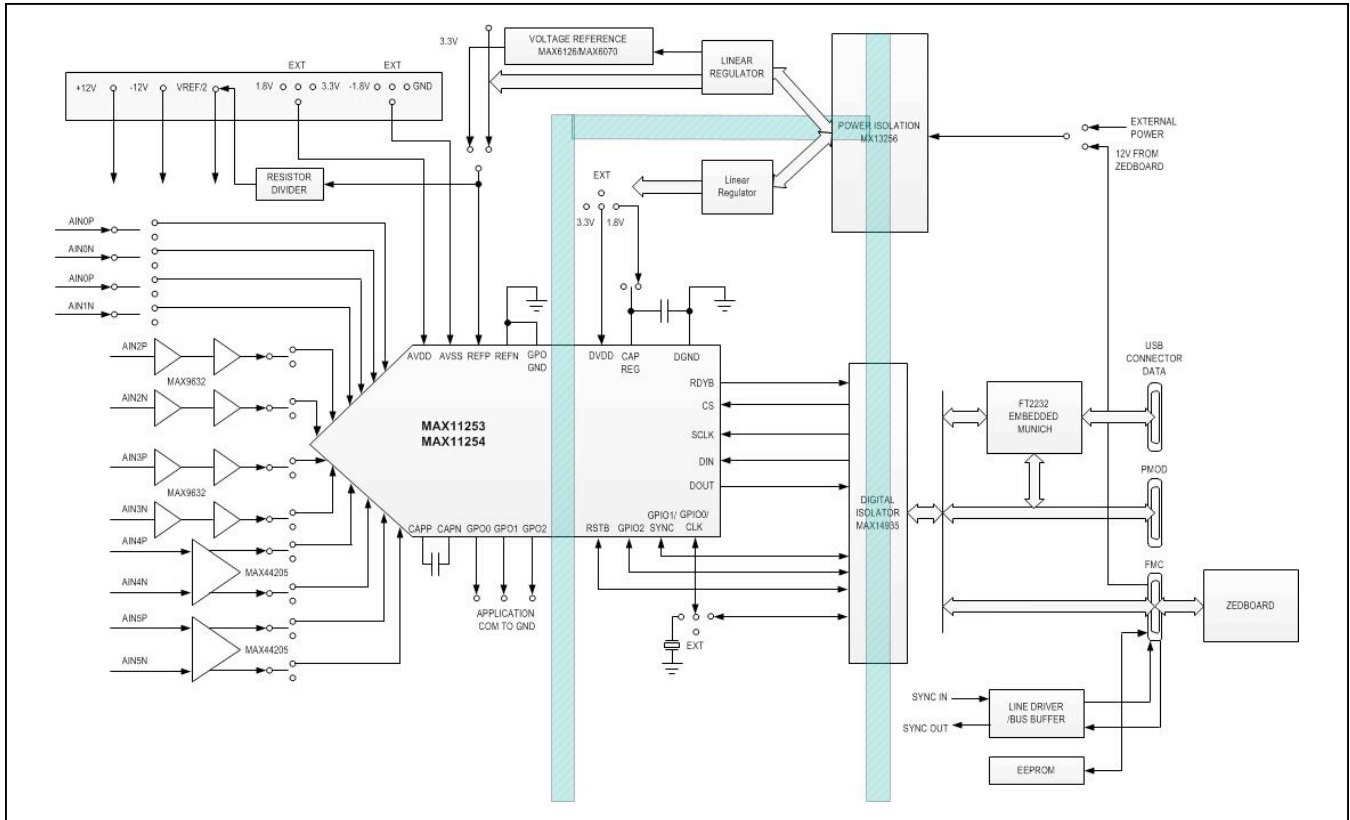

MAX11253/MAX11254 EV Kit Files

FILE	DECIPTION
MAX11253_54EVKitSetupV1.0.exe	Application Program (GUI)
Boot.bin	ZedBoard firmware (SD card to boot Zynq)

Quick Start

Required Equipment

- MAX11253/MAX11254 EV kit
- +12V (500mA) power supply
- Micro-USB cable
- ZedBoard FPGA platform (optional – **NOT INCLUDED** with EVKit)
- Function generator (optional)
- Windows XP, Windows 7, or Windows 8.1 PC with a spare USB port

Note: In the following section(s), software-related items are identified by bolding. Text in **bold** refers to items directly from the EV system software. Text in **bold and under-line** refers to items from the Windows operating system.

Procedure

The EV kit is fully assembled and tested. Follow the steps below to verify board operation:

- 1) Visit <http://www.maximintegrated.com/evkitsoftware> to download the latest version of the EV kit software, MAX11253_54EVKITSetupV1.0.zip. Save the EV kit software to a temporary folder and uncompress the ZIP file.
- 2) Install the EV kit software and USB driver on your computer by running the MAX11253_54EVKitSetupV1.0.exe program inside the temporary folder. The program files are copied to your PC and icons are created in the Windows **Start | Programs** menu. At the end of the installation process the installer will launch the installer for the FTDIChip CDM drivers.

For Standalone mode:

- 1) Verify that all jumpers are in their default positions for the EV kit board (Table 2).
- 2) Connect the PC to the EV kit using a micro-USB cable.
- 3) Connect the +12V adapter to the EV kit.
- 4) Start the EV kit software by opening its icon in the **Start | Programs** menu. The EV kit software appears as shown in Figure 1. From the **Device** menu select **Standalone**. Verify that the lower left status bar indicates the EV Kit hardware is **Connected**.

For FPGA mode (when connected to a Zedboard):

- 1) Connect the Ethernet cable from the PC to the ZedBoard and configure the Internet Protocol Version 4 (TCP/Ipv4) properties in the local area connection to IP address 192.168.1.2 and subnet Mask to 255.255.255.0.
- 2) Verify that the ZedBoard SD card contains the Boot. bin file for the MAX11253/MAX11254 EV kit.
- 3) Connect the EV kit FMC connector to the ZedBoard FMC connector. Gently press them together.
- 4) Verify that all jumpers are in their default positions for the ZedBoard (Table 1) and EV kit board (Table 2).
- 5) Connect the 12V power supply to the ZedBoard. Leave the Zedboard powered off.
- 6) Enable the ZedBoard power supply by sliding SW8 to ON and connect the +12V adapter to the EV kit.

- 7) Start the EV kit software by opening its icon in the **Start | Programs** menu. The EV kit software appears as shown in Figure 1. From the **Device** menu select **FPGA**. Verify that the lower left status bar indicates the EV Kit hardware is **Connected**.

For Either Standalone or FPGA Mode:

- 1) Connect the positive terminal of the function generator to the AIN0D+ (TP1) test point on the EV kit. Connect the negative terminal of the function generator to the AIN0D- (TP2) test point on the EV kit.
- 2) Configure the signal source to generate a 100Hz, 1V_{p-p} sinusoidal wave with +1V offset.
- 3) Turn on the function generator.
- 4) In the Device menu, choose either standalone or the FPGA option. In the configuration group, select Channel 0 and click **Convert** in the serial interface menu.
- 5) Click on the Scope tab.
- 6) Check the **Remove DC Offset** checkbox to remove the DC component of the sampled data.
- 7) Click the **Capture** button to start the data analysis.
- 8) The EV kit software appears as shown in Figure 1.
- 9) Verify that the frequency, which is displayed on the right, is approximately 100Hz. The scope image has buttons in the upper right corner that allow zooming in to detail.

Table 1. ZedBoard Jumper Settings

JUMPER	SHUNT POSITION	DESCRIPTION
J18	1-2	VDDIO set for 3.3V.
JP11	2-3	Boot from SD Card
JP10	1-2	
JP9	1-2	
JP8	2-3	
JP7	2-3	
J12	NA	SD Card installed
J20	NA	Connected to 12V wall adapter
SW8	OFF	ZedBoard power switch, OFF while connecting boards

Table 2. MAX11253/MAX11254 Board Jumper Settings

HEADER	JUMPER POSITION	DESCRIPTION
JMP1	1-2*	Use MAX6126 3.0V as VREF signal
	1-3	Use MAX6070 3.0V as VREF signal
	1-4	Use MAX6070 1.8V as VREF signal
J8	Open*	Generate +3.3V for DVDD
	1-2	Generate +2.0V for DVDD
J10	1-2*	Select +3.3V or +2.0V as DVDD
	2-3	Select +1.8V as DVDD
J11	Open*	U1 uses internal clock
	1-2	External clock from FPGA
	2-3	External clock from U10
J12	1-2*	Select +3.3V as AVDD
	2-3	Select +1.8V as AVDD
J13	1-2*	Select AVSS as REFN
	2-3	Select REFN_S from J1 as REFN for external sense point
J14	Open*	Use internal 1.8V subregulator if DVDD ≥ 2.0V
	1-2	Use DVDD for internal logic if DVDD ≤ 2.0V
J15	Open*	Use TP23 as GPIO1
	1-2	Use external SYNC signal
J16	1-2*	Select REFP_F signal as REFP input
	2-3	Select REFP_S signal from J1 as REFP input
J17	1-2*	Use AGND as AVSS. Use this setting if AVDD is +3.3V
	2-3	Use -1.8V as AVSS. Use this setting if AVDD is +1.8V
J24	1-2*	Use VREF as REFP_F
	2-3	Use AVDD as REFP_F
J31	1-2*	Short AIN2.1- (J27, TP38) to AGND and for U11 noninverting configuration
	3-4*	Short AIN2.1+ (J28, TP39) to AGND and for U11 inverting configuration

HEADER	JUMPER POSITION	DESCRIPTION
J32	1-2*	Short AIN2.3- (J29, TP42) to AGND and for U12 noninverting configuration
	3-4*	Short AIN2.3+ (J30, TP43) to AGND and for U12 inverting configuration
J33	1-2*	Short AIN2.2- (TP40) to AGND and for U13 noninverting configuration
	3-4*	Short AIN2.2+ (TP41) to AGND and for U13 inverting configuration
J34	1-2*	Short AIN2.4- (TP44) to AGND and for U14 noninverting configuration
	3-4*	Short AIN2.4+ (TP45) to AGND and for U14 inverting configuration
J35	1-2*	Connect output of U11 to inverting input of U13
	3-4	Connect AIN2.2- (TP40) to inverting input of U13
	5-6	Connect output of U11 to noninverting input of U13
	7-8*	Connect AIN2.2+ (TP41) to noninverting input of U13
J36	1-2*	Connect output of U12 to inverting input of U14
	3-4	Connect AIN2.4- (TP44) to inverting input of U14
	5-6	Connect output of U12 to noninverting input of U14
	7-8*	Connect AIN2.4+ (TP45) to noninverting input of U14
J37	Open*	No offset to U13 noninverting input
	1-2	Offset U13 output by VREF/2
J38	Open*	No offset to U14 noninverting input
	1-2	Offset U14 output by VREF/2

Table 2. MAX11253/MAX11254 Board Jumper Settings (continued)

HEADER	JUMPER POSITION	DESCRIPTION
J39	1-2*	Short AIN3.1- (TP56) to AGND and for U15 noninverting configuration
	3-4*	Short AIN3.1+ (TP57) to AGND and for U15 inverting configuration
J40	1-2*	Short AIN3.3- (TP60) to AGND and for U16 noninverting configuration
	3-4*	Short AIN3.3+ (TP61) to AGND and for U16 inverting configuration
J41	1-2*	Short AIN3.2- (TP58) to AGND and for U17 noninverting configuration
	3-4*	Short AIN3.2+ (TP59) to AGND and for U17 inverting configuration
J42	1-2*	Short AIN3.4- (TP62) to AGND and for U18 noninverting configuration
	3-4*	Short AIN3.4+ (TP63) to AGND and for U18 inverting configuration
J43	1-2*	Connect output of U15 to inverting input of U17
	3-4	Connect AIN3.2- (TP58) to inverting input of U17
	5-6	Connect output of U15 to noninverting input of U17
	7-8*	Connect AIN3.2+ (TP59) to noninverting input of U17
J44	1-2*	Connect output of U16 to inverting input of U18
	3-4	Connect AIN3.4- (TP62) to inverting input of U18
	5-6	Connect output of U16 to noninverting input of U18
	7-8*	Connect AIN3.4+ (TP63) to noninverting input of U18
J45	Open*	No offset to U17 noninverting input
	1-2	Offset U17 output by VREF/2

HEADER	JUMPER POSITION	DESCRIPTION
J46	Open*	No offset to U18 noninverting input
	1-2	Offset U18 output by VREF/2
J49	1-2*	Short AIN4+ (J47, TP72) to AGND
	3-4*	Short AIN4- (J48, TP73) to AGND
J50	1-2*	Short AIN5+ (TP74) to AGND
	3-4*	Short AIN5- (TP75) to AGND
J63	Open*	Use external +12V source
	1-2	Use +12V from ZedBoard
J64	Open	If connected to ZedBoard FPGA
	1-2*	If connected to PC through USB interface
J65	1-2*	Enable U28 H-bridge transformer driver to use onboard ±15V supply generation
	2-3	Disable U28 and use and external ±15V supply to TP83, TP86, and TP87
J66	1-2	Use an external -15V power supply, connected to TP86
	3-4*	Use U28 driver to generate isolated -15V
J67	1-2	Use an external +15V power supply, connected to TP83
	3-4*	Use U28 driver to generate isolated +15V
J68	1-2	Use an external +12V power supply to TP91 as VCC
	3-4*	Use onboard +12V from U32 LDO as VCC
J69	1-2	AGND as VEE
	3-4	Use an external -12V power supply to TP90 as VEE
	5-6*	Use onboard -12V from U33 LDO as VEE

*Default configuration

General Description of Software

The main window of the EV kit software contains seven tabs: Configuration, Scope, DMM, Histogram, FFT, Scan Mode, and Registers. The Configuration tab provides control for the ADC configuration including calibration and data capture. The other six tabs are used for evaluating the data captured by the ADC.

Configuration Tab

The **Configuration** tab provides an interface for selecting and configuring the ADC from a functional perspective. Select the desired **Device** for either Standalone or FPGA in the dropdown menu and the corresponding properties of the device are displayed including **Channel** number, **Sample Rate**, **Number of Samples**, **Reference Voltage**, **Sequencing Mode**, **Calibration**, **GPO/GPIO selection**, **Input Path (Direct or internal PGA)**, **Delta-Sigma Modulator** type selection for different **Data Format** and **Conversion Mode**, **Serial Interface** function (**Convert**, and **Read All**), **Power** setting (**NOP**, **Power Down**, and

Standby), **Reset Registers**, and **RSTB Reset**, **Clock/SYNC (Internal or External Clock**, and **Disable or Enable SYNC Mode**), and **Other** for **Disable or Enable Current Sink/Source** and **CAPREG LDO**.

The sample settings are available on the left of the configuration menu, which allow the user to select the **Channel**, **Sample Rate**, **Number of Samples** and **Clock Source** if **FPGA** device is used.

The **Read Data** and **Status** information is displayed on the right, which shows the data in both voltage and Hex, the sample rate, and power state for the selected channel. In addition, if there are any errors, the indicator lights will turn red.

Channel Selection

To select the desired channel among the six available channels, click **Channel #** dropdown menu at the top left and select the desired channel from 0 to 5. The default selection is **Channel 0**.

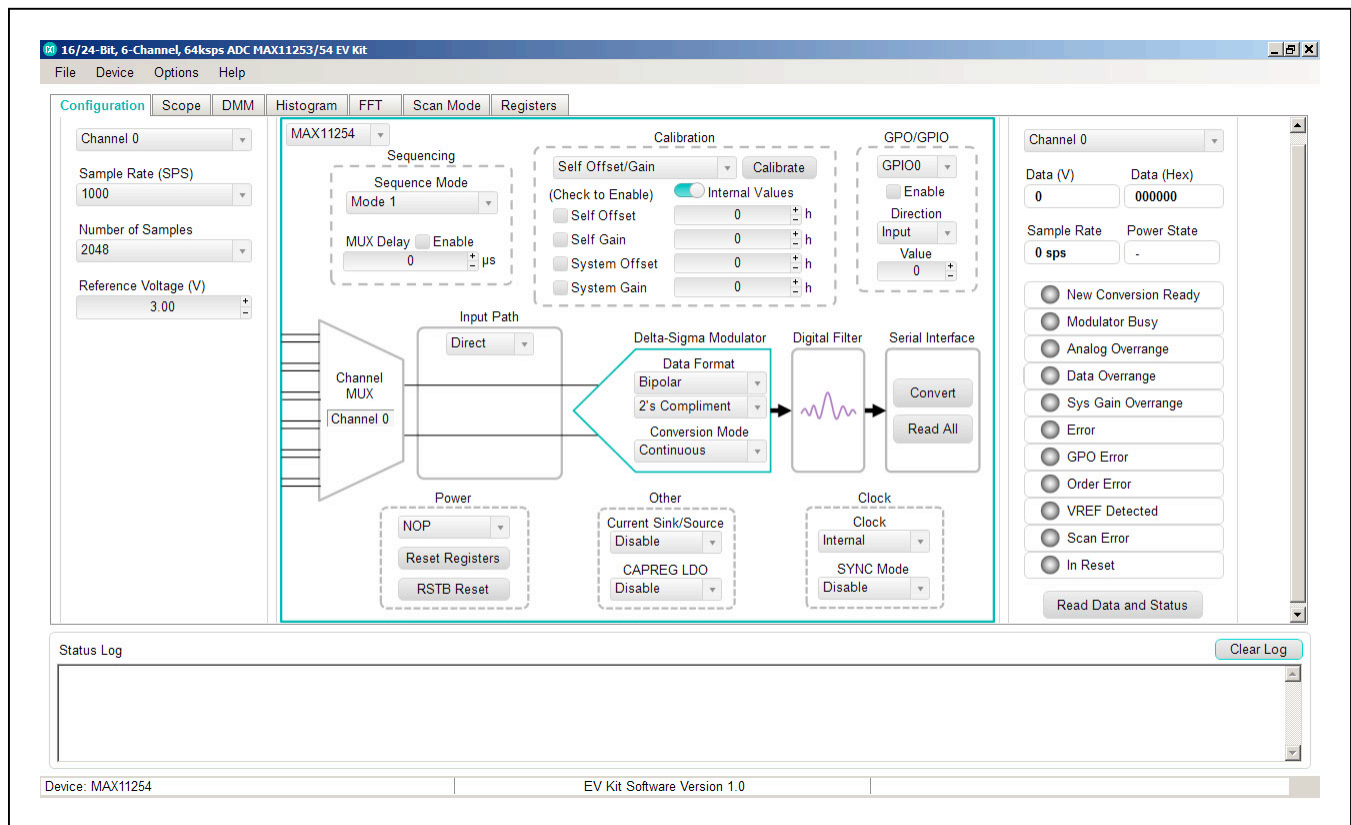

Figure 1. EV Kit Software (Configuration Tab)

Sample Rate (SPS)

To select the desired data rate for single-cycle mode from 50sps to 12800sps and for continuous mode data rate from 1.9sps to 64000sps, choose the **Sample Rate (SPS)** from the dropdown menu below the **Channel #** selection.

Reference Voltage

There are three different reference voltages available on board: MAX6070AUT18+ (1.8V), MAX6070AUT30+ (3.0V), and MAX6126AASA30+ (3.0V). To select 1.8V, place JMP1 from position 1 to 4. To select 3.0V MAX6070 with $\pm 0.04\%$ accuracy, place JMP1 from position 1 to 3. To select 3.0V MAX6126 with $\pm 0.02\%$ accuracy, place JMP1 from position 1 to 2.

Sequencer Mode

To change the sequencer mode, click the **Sequence Mode** selection below the **Sequencing** menu and select Mode 1, 2, or 3 as desired. Check the **GPO Sequencer Mode** box to enable GPO/GPIO function in mode 3. In addition, check the Enable box to enable the **MUX and GPO Delay**. Choose the desired delay in microseconds by clicking on the **+** or **-** buttons.

ADC Calibration

Two types of software calibration for offset and gain are available: Self calibration and system calibration.

The primary mode for calibration is using the dropdown list to select a calibration mode, followed by clicking the **Calibrate** button. The checkboxes for **Self Offset**, **Self Gain**, **System Offset**, and **System Gain** allow for the user to enable or disable the calibration values. The calibration values can also be changed manually by entering a hex value in the numeric box.

GPO/GPIO

To select GPO or GPIO ports, choose the option under the **GPO/GPIO** dropdown menu and check the **Enable** box.

Input Path

Select **Direct** under the **Input Path** dropdown menu to bypass the internal amplifiers and apply the analog input signals directly to the MAX11253/MAX11254 inputs or to use the external amplifiers.

Select **PGA** under the **Input Path** dropdown menu to use the internal programmable gain amplifiers.

Delta-Sigma Modulator

To select the desired data format, click the **Data Format** dropdown menu under the **Delta-Sigma Modulator** section and choose either Bipolar or Unipolar with two's complement or offset binary options.

Three conversion modes are provided: **Continuous**, **Single Cycle**, and **Single Continuous**. Click the **Conversion Modes** dropdown menu under the **Delta-Sigma Modulator** section to select the desired conversion mode.

Serial Interface

To starting converting, click the **Convert** button under the Serial interface section. To read all registers, click the **Read All** button.

Power

The MAX11253/MAX11254 EV kit features three power-down states: **Normal Operating Power (NOP)**, **Power down**, and **Standby**. Select the desired power state by clicking the drop-down menu under the **Power** section.

To reset the configuration settings back to default values, press the **Reset Registers** button.

To exercise the power-on reset feature, click the **RSTB** button.

Clock/SYNC

The internal clock mode is set at default condition. To use the external clock provided on-board, select **External** under the **Clock/SYNC** section and install jumper J11 from 2-3. To user-supplied external clock, select External under the **Clock/SYNC** section and install jumper J11 from 1-2. In addition, the Sync mode can be enabled or disabled by clicking the drop-down menu under this **Clock/SYNC** section and install jumper J15. The Sync signal should be provided externally.

Other

To enable (J14 open) or disable (J14 installed and $V_{DDVD} \leq 2.0V$) the internal **CAPREG LDO** for digital and I/O supply, select this option from the drop-down menu under the **Other** section. Additionally, **Current Sink/Source** can also be disabled or enabled under this section.

Read Data and Status

The **Read Data and Status** on the far right hand side of this **Configuration** menu depicts the received data and status of the device such as the selected channel, data rate, sample rate, and power state. Click the **Read Data and Status** button to view the updated status.

To save a configuration, select Save ADC Config As... in the File menu. This saves all the ADC register values to a XML file. To load a configuration, select Load ADC Config in the File menu. When the XML file is loaded, all the register values in the file are written to the ADC.

Scope Tab

The Scope tab sheet is used to capture data and display it in the time domain. The desired **Channel #**, **Sample Rate**, **Number of Samples**, **Display Unit**, **Average Samples**, and **Resolution Selection** can also be set in this tab if they were not appropriately adjusted in other tabs. The **Display Unit** drop-down list allows counts in LSB and voltages in V, mV, or μ V. Once the desired configuration is

set, click on the **Capture** button. The right side of the tab sheet displays details of the waveform, such as average, standard deviation, maximum, minimum, and fundamental frequency as shown in [Figure 2](#).

To save the captured data to a file, select **Options > Save Graph > Scope**. This saves the setting on the left and the data captured to a CSV file.

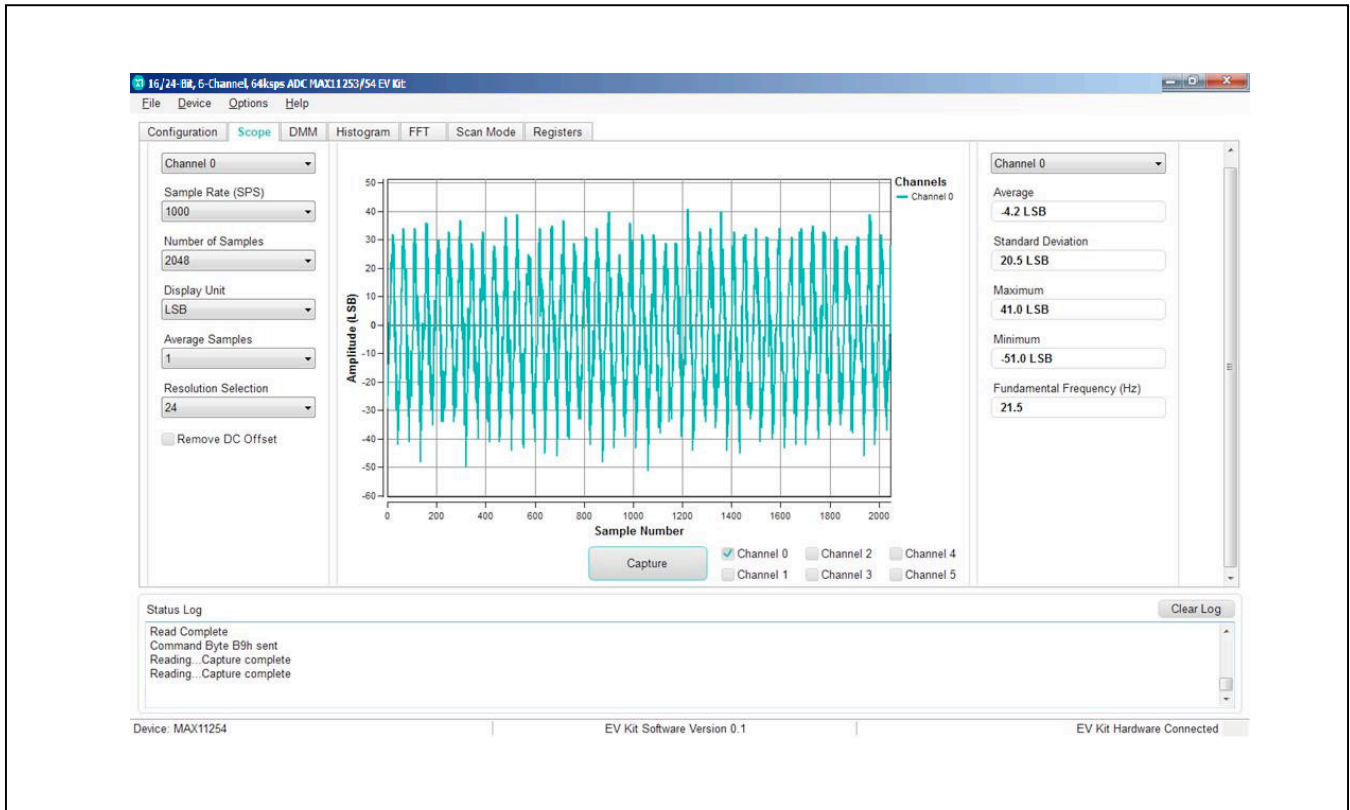

Figure 2. EV Kit Software (ScopeTab)

DMM Tab

The **DMM** tab sheet provides the typical information as a digital multimeter. Once the desired configuration is set,

click on the **Capture** button. [Figure 3](#) displays the results shown by the **DMM** tab when a 1.5V signal is applied to AIN0+ and 1.0V to AIN0-.

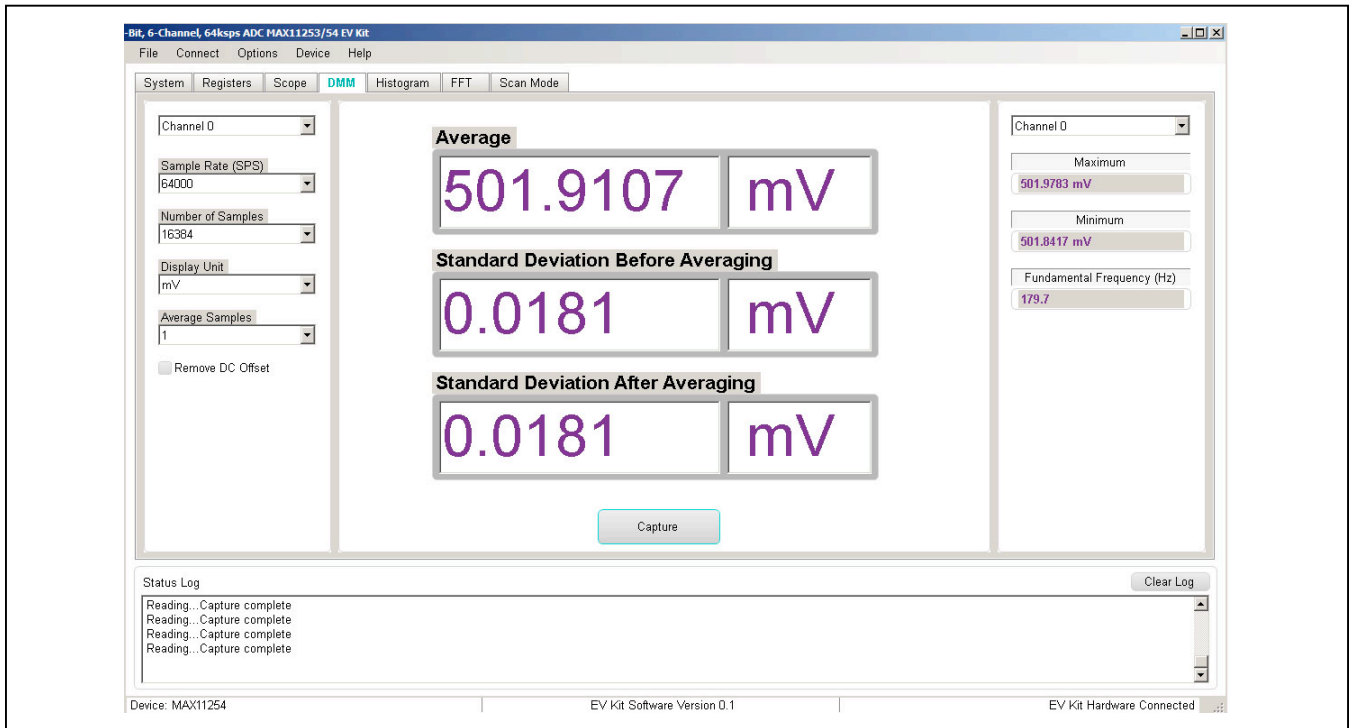

Figure 3. EV Kit Software (DMM Tab)

Histogram Tab

The **Histogram** tab sheet is used to show the histogram of the data. Sample rate and number of samples can also be set in this tab if they were not appropriately adjusted in other tabs. Once the desired configuration is set, click on the **Capture** button. The right side of the tab sheet displays details of the histogram such as average, standard deviation, maximum, minimum, peak-to-peak noise, effective resolution, and noise-free resolution as shown in [Figure 4](#).

The histogram tab is enabled at default. Using the histogram will slow down the GUI response. To disable it, check the **Disable Histogram** box.

To save the histogram data to a file, go to **Options > Save Graph > Histogram**. This saves the setting on the left and the histogram data captured to a CSV file.

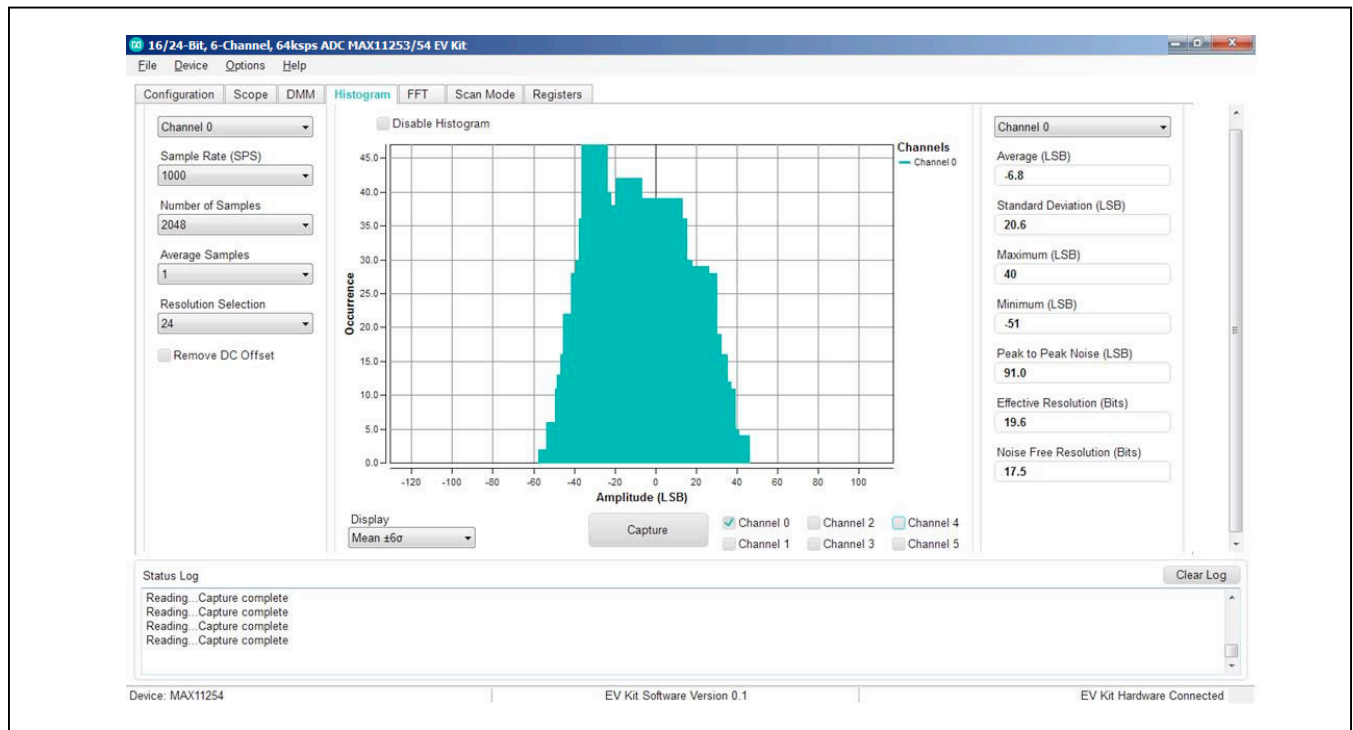

Figure 4. EV Kit Software (Histogram Tab)

FFT Tab

The FFT tab sheet is used to display the FFT of the data. The **Sample Rate**, **Number of Samples**, **Resolution** and **Window Function** type can be set as desired. To calculate the **Adjusted Input Signal** frequency for **Coherent Sampling**, enter the **Input Signal** frequency in Hertz and push the Calculate button. Once the preferred configuration is set, click on the **Capture** button. The right side of the tab displays the performance based on the FFT, such as fundamental frequency, SNR, SINAD, THD, SFDR, ENOB, and Noise Floor as shown in [Figure 5](#).

To save the FFT data to a file, go to **Options > Save Graph > FFT**. This saves the setting on the left and the FFT data captured to a CSV file.

When coherent sampling is needed, this tab allows the user to calculate the external clock frequency applied to the board. Adjust the input frequency of the low-jitter clock to the value as shown in the **Adjusted Master Clock (Hz)** and apply it to the EV KIT EXT_CLK connector. See the [Sync Input and Sync Output](#) section before using this feature.



Figure 5. EV Kit Software (FFT Tab)

MAX11253/MAX11254 Family Evaluation Kit

Evaluates: MAX11253/MAX11254

Figure 6 shows the setup Maxim Integrated uses to capture data for coherent sampling. For coherent FFT evaluation, use the jumper settings from Table 2 for proper configurations. The low-jitter clock is synchronized with the signal generator at 10MHz from the ZedBoard. To achieve coherent sampling, click on the

Calculate button and enter the **Adjusted Master Clock (Hz)** frequency of approximately **8.192MHz** into our low-jitter clock. Timing for all SPI timing and sampling rate are based off the system clock.

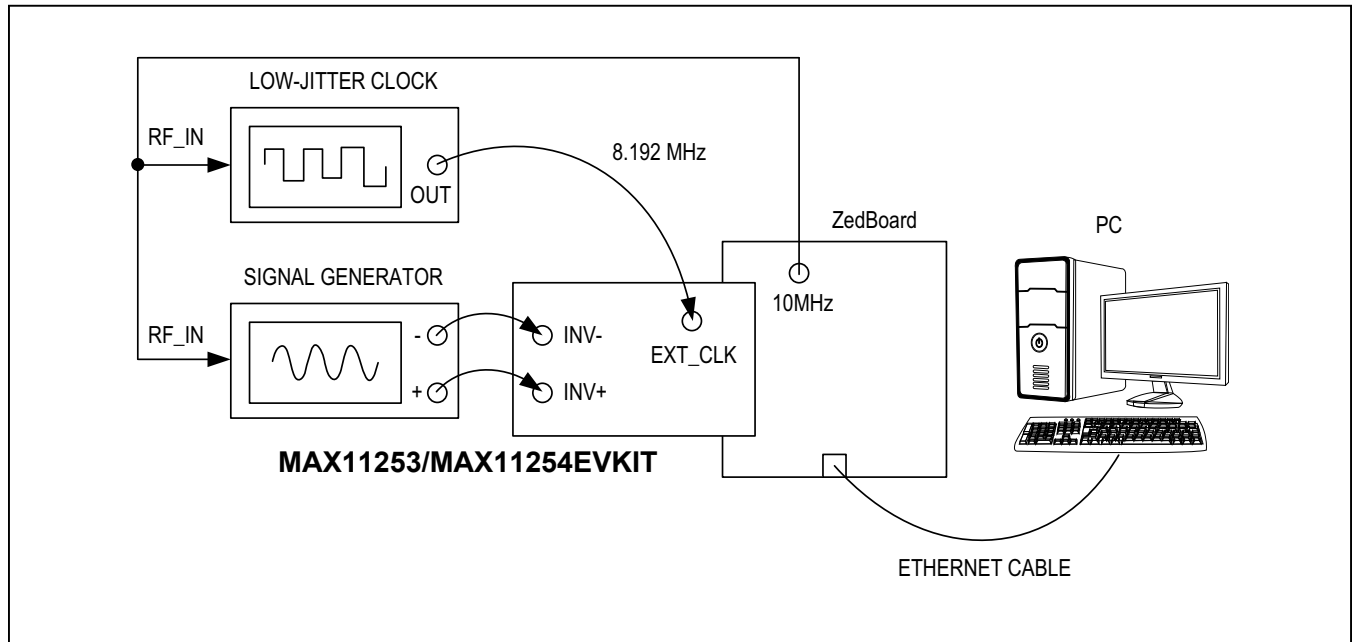

Figure 6. EV Kit Coherent Sampling Setup

Scan Mode Tab

The **Scan Mode** tab is used to perform selected data conversions and read the converted data.

In the **Sequence Setting** section at the bottom, set the desired sequencer mode (1 to 3) from the **Sequence Mode** drop-down menu and select whether to assert the RDYB pin **after one channel** or **after scan completes** under the **RDYB** menu. Check the **GPO Sequencer Mode** and **Enable** boxes as desired. Then set the conversion time delay in μs for MUX and GPO by clicking on the + or - buttons under the **MUX Delay** and **GPO Delay** menu, allowing for high impedance source networks to stabilize after the channels are selected. Finally press the **Read All** button to view the selected settings.

In the **Read Data** section on top, select the desired unit in either LSB or voltage (V, mV, or μV) under the **Display Unit** drop-down menu. Then choose the desired sample rate by clicking on the **Sample Rate** drop-down menu under. Finally, click the Scan button to start converting and press the **Read Data** button to view the converted data displayed on the right hand side as shown in [Figure 7](#).

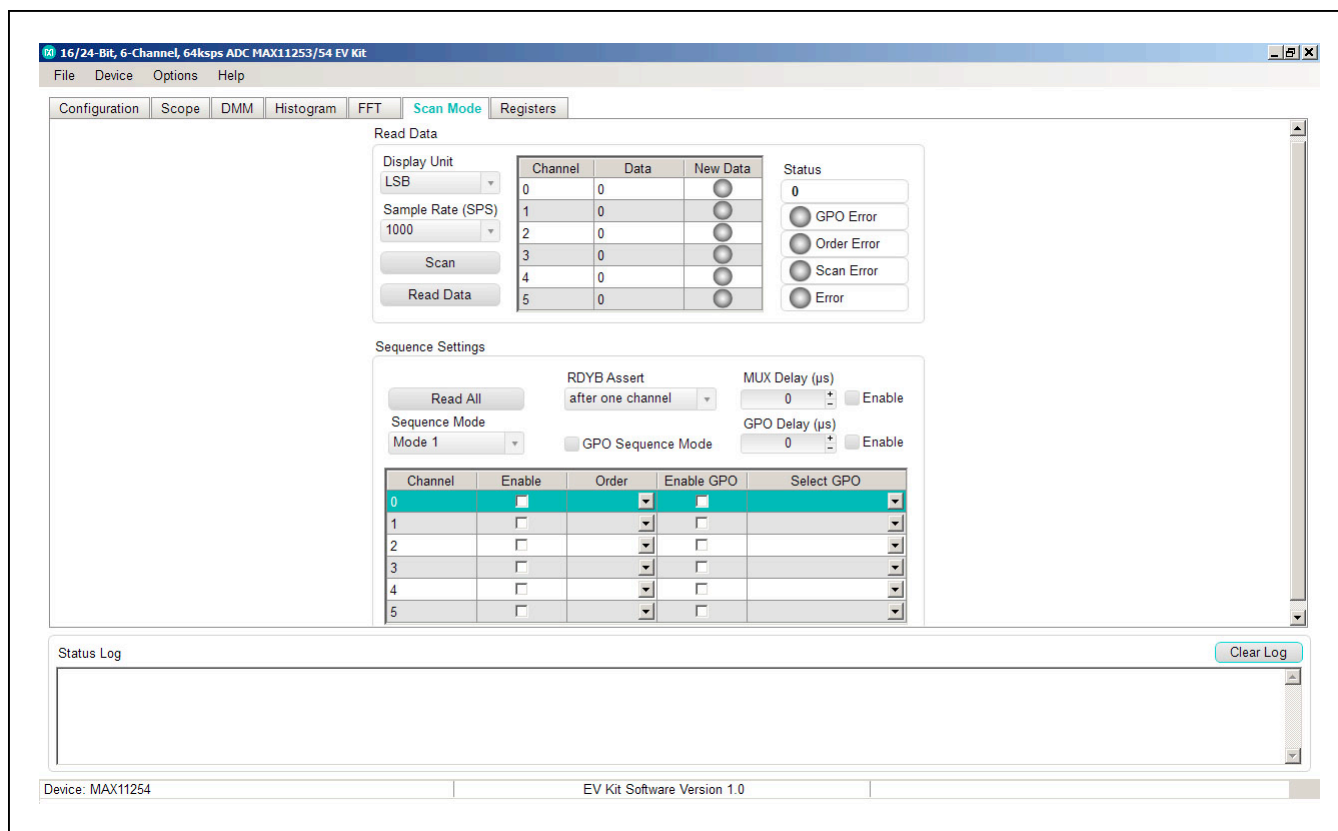

Figure 7. EV Kit Software (Scan Mode Tab)

MAX11253/MAX11254 Family Evaluation Kit

Evaluates: MAX11253/MAX11254

ADC Registers Tab

The **Registers** tab sheet shows the device registers on the left. The middle section shows the descriptions of the selected register. Click **Read All** to read all registers and refresh the window with the register settings. To write a register first select the hex value in the **Value** column, type the desired hex value and press **Enter**.

The command byte is on the right side of the tab sheet. This byte precedes all SPI transactions and is described in the IC datasheet. To send a command byte enter a hex value in the numeric box and click the **Send** button. The command byte has two different formats including **Conversion Command** and **Register Read/Write**. Select the radio button for the desired mode to see the bit description in the table. See [Figure 8](#).

Detailed Description of Hardware

The MAX11253/MAX11254 EV kit provides a proven signal path and board layout to demonstrate the performance of the MAX11253/MAX11254 16-/24-bit, delta-sigma ADCs. Included in the EV kit are digital isolators, isolated DC-DC converters, ultra-low-noise LDOs to all supply pins of the IC, on-board reference (MAX6126 and MAX6070), precision amplifiers (MAX9632 and MAX44205) for analog inputs, and sync-in and sync-out signals for coherent sampling.

An on-board FTDI controller is provided to allow for evaluation in standalone mode, which has limitations on maximum sample speed and on sample depth. The EV kit can be used with FPGA to achieve full speed and a larger sample depth.

The EV kit supports a number of different devices as listed in [Table 3](#).

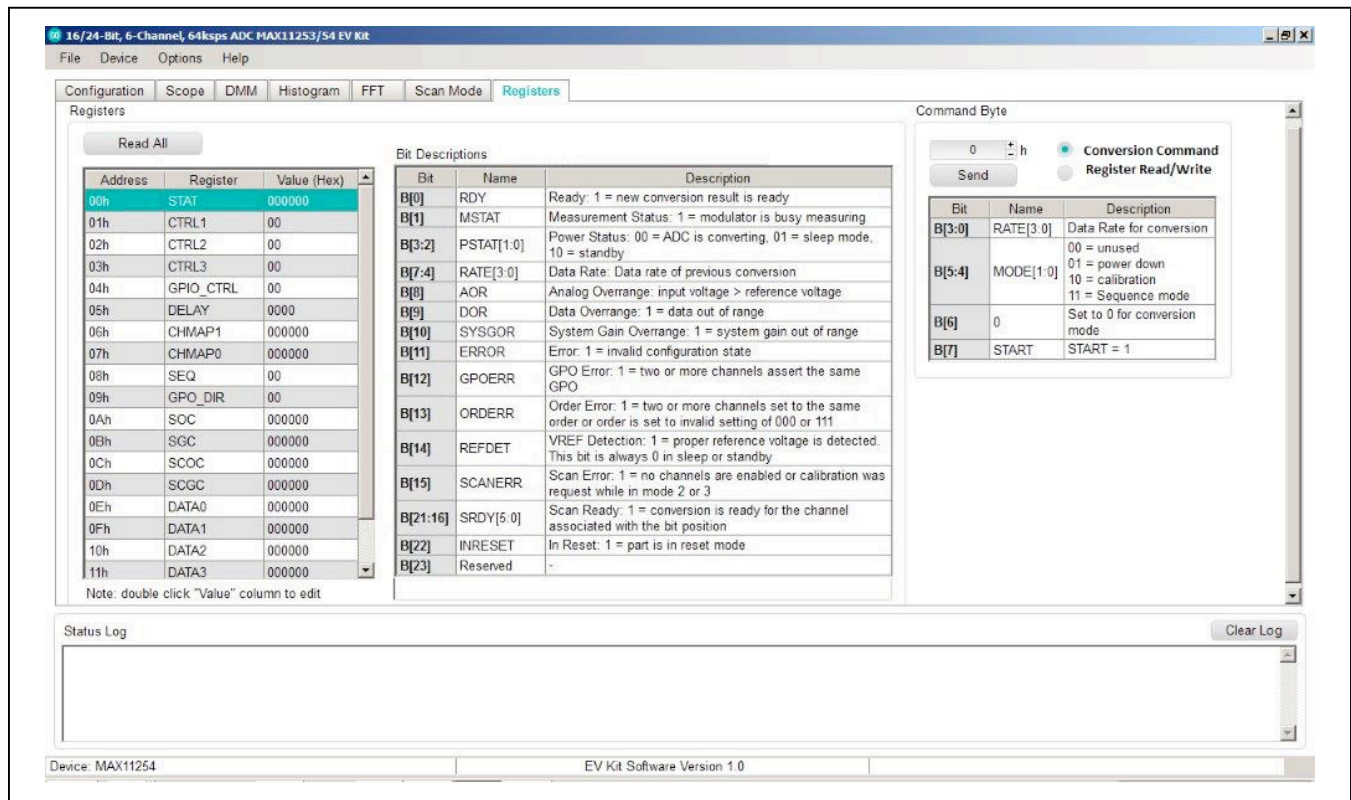

Figure 8. EV Kit Software (ADC Registers Tab)

Table 3. Products Supported with MAX11253/MAX11254 EV Kit

PART NO.	RESOLUTION	MAX. SAMPLE RATE
MAX11253	16-bits	64ksps
MAX11254	24-bits	64ksps

MAX11253/MAX11254 Family Evaluation Kit

Evaluates: MAX11253/MAX11254

User-Supplied SPI

To evaluate the EV kit with a user-supplied SPI bus, disconnect from the FMC bus and remove jumper J64. Apply the user-supplied SPI signals to SCLK, CSB, DIN, and DOUT at the PMOD_A header (J60). Make sure the return ground is connected to PMOD ground.

The on-board FTDI chip used for standalone mode does not conflict with the user-supplied SPI if it is powered off by removing jumper J64.

CAUTION: DO NOT PLUG THIS HEADER INTO A STANDARD PMOD INTERFACE FOUND ON OTHER FPGA OR MICROCONTROLLER PRODUCTS. THE SIGNAL DEFINITION IS UNIQUE TO THIS EV KIT.

FMC Interface:

The users should confirm compatibility of pin-usage between their own FMC implementation and that of the Maxim Integrated EV kit before connecting the Maxim Integrated EV kit to a different system with FMC connectors.

Voltage References

There are three different reference voltages available on board: MAX6070AUT18+ (1.8V), MAX6070AUT30+ (3.0V), and MAX6126AASA30+ (3.0V). To select 1.8V, place JMP1 from position 1 to 4. To select 3.0V MAX6070 with ±0.04% accuracy, place JUMP1 from position 1 to 3. To select 3.0V MAX6126 with ±0.02% accuracy, place JMP1 from position 1 to 2.

For user-supplied external references, remove jumper J24 and connect a reference voltage to J24-2. Measure and enter the value of the external reference voltage into the **Reference Voltage** edit box on the **Configuration** tab of the GUI. [Table 3](#) depicts the reference source options.

External DVDD Power Supply

The internal 1.8V regulator can be replaced by an external supply in the range of 1.7V to 2.0V. To use external DVDD, **disable** the internal regulator by selecting the **Disable** in the **CAPREG LDO** drop-down menu in the **Other** section and install J14.

User-Supplied Power Supply

The EV kit receives power from a single DC source of 12V, 500mA through a J61 power jack. The MAX13256, H-bridge driver and transformer create an additional negative rail for +15V and -15V. The power is then rectified and regulated down to a +12V and -12V supplies for the MAX9632 op amps, as well as +5V and -5V supplies for the MAX44205 op amps. Additional supplies are generated for +1.8V/-1.8V and +2V/+3.3V for the ADCs and VREFs. See the EV kit schematic pdf for details. Specific

voltages can be connected to the board for each rail, see [Table 4](#) for corresponding jumper positions.

ADC Input Amplifiers

The input amplifiers allow for significant flexibility, supporting bipolar or unipolar input paths, as well as the option for gain control. Selected input amplifiers can be configured as inverting, noninverting, differential bipolar, and differential unipolar. See [Table 5](#) for these analog input configurations for channels 0 to 5.

The analog front-end consists of six channels, 0 to 5, and there are four user-selectable input pairs (for example AINx+ and AINx- where x is 2, 3, 4 or 5) allowing selection between one of two op amp solutions, the MAX9632 a 36V, precision, low-noise, wide-band amplifier or the MAX44205, a 180MHz, low-noise, low-distortion, fully differential op amp. The op amps can be configured as inverting or noninverting amplifiers by jumper selectors. Both op amps work as anti-aliasing lowpass filters (LPF) and can be daisy-chained to create a second-order LPF.

The range of possible configurations are listed in [Table 5](#).

Table 4. Reference Source Options

REF SOURCE	JUMPER	CONNECTION	FUNCTION
MAX6070 (1.8V)	JMP1	1-4	Select U7 MAX6070
	J13	1-2	
	J16	1-2	
	J24	1-2	
MAX6070 (3.0V)	JMP1	1-3	Select U8 MAX6070
	J13	1-2	
	J16	1-2	
	J24	1-2	
MAX6126 (3.0V)	JMP1	1-2	Select U9 MAX6126
	J13	1-2	
	J16	1-2	
	J24	1-2	
AVDD	J13	1-2	Select AVDD
	J16	1-2	
	J24	2-3	
User-Supplied	J13	1-2	Select User-Supplied Reference
	J16	1-2	
	J24	Open. Connect user-supplied reference to J24-2	

Table 5. Power Supply to the Board

POWER	INPUT CONNECTORS	JUMPERS
Single +12V input from a wall adapter (default)	J61	J67: 3-4 J66: 3-4 J68: 3-4 J69: 5-6 J65: 1-2 J64: 1-2 (select onboard FTDI) J63: 1-2 (select FPGA ZedBoard)
An external ±12V	TP91 (+12V) TP90 (-12V)	J67: 3-4 J66: 3-4 J68: 1-2 J69: 3-4 J65: 1-2 J64: 1-2 (select onboard FTDI) J63: 1-2 (select FPGA ZedBoard)
An external ±15V	TP86 (+15V) TP83 (-15V)	J67: 1-2 J66: 1-2 J68: 3-4 J69: 5-6 J65: 1-2 J64: 1-2 (select onboard FTDI) J63: 1-2 (select FPGA ZedBoard)

Table 6. Analog Input Configurations (CH0–CH5)

CONFIGURATION		ADC INPUT CONFIGURATION	INPUT CONNECTORS	JUMPER POSITIONS
NO.	DESCRIPTION			
1	Channel 0	User-supplied signals, differential	AIN0D+, AIN0D-	N/A
2	Channel 1	User-supplied signals, differential	AIN1D+, AIN1D-	N/A
3	MAX9632, Channel 2	Noninverting, differential, second-order LPF	J28: AIN2.1+ (or TP39): AIN2.1+ and AGND J30: AIN2.3+ (or TP43): AIN2.3+ and AGND	J31: 1-2 J35: 5-6 and 3-4 J33: 1-2 J32: 1-2 J36: 5-6 and 3-4 J34: 1-2 J4: 3-4 and 5-6 J37: 1-2 (for bipolar signal or open for unipolar signal) J38: 1-2 (for bipolar signal or open for unipolar signal)

Table 6. Analog Input Configurations (CH0–CH5) (continued)

CONFIGURATION		ADC INPUT CONFIGURATION	INPUT CONNECTORS	JUMPER POSITIONS
NO.	DESCRIPTION			
4	MAX9632, Channel 2	Inverting, differential, second-order LPF	J27: AIN2.1- (or TP38): AIN2.1- and AGND J29: AIN2.3- (or TP42): AIN2.3- and AGND	J31: 3-4 J35: 1-2 and 7-8 J33: 3-4 J32: 3-4 J36: 1-2 and 7-8 J34: 3-4 J4: 3-4 and 5-6 J37: 1-2 (for bipolar signal or open for unipolar signal) J38: 1-2 (for bipolar signal or open for unipolar signal)
5	MAX9632, Channel 2	Noninverting, differential, first-order LPF	AIN2.2+ (or TP41): AIN2.2+ and AGND AIN2.4+ (or TP45): AIN2.4+ and AGND	J35: 7-8 and 3-4 J33: 1-2 J34: 1-2 J36: 7-8 and 3-4 J4: 3-4 and 5-6 J37: 1-2 (for bipolar signal or open for unipolar signal) J38: 1-2 (for bipolar signal or open for unipolar signal)
6	MAX9632, Channel 2	Inverting, differential, first-order LPF	AIN2.2- (or TP40): AIN2.2- and AGND AIN2.4- (or TP44): AIN2.4- and AGND	J35: 7-8 and 3-4 J33: 3-4 J34: 3-4 J36: 7-8 and 3-4 J4: 3-4 and 5-6 J37: 1-2 (for bipolar signal or open for unipolar signal) J38: 1-2 (for bipolar signal or open for unipolar signal)
7	MAX9632, Channel 3	Noninverting, differential, second order LPF	AIN3.1+ (or TP57): AIN3.1+ and AGND AIN3.3+ (or TP61): AIN3.3+ and AGND	J39: 1-2 J43: 5-6 and 3-4 J41: 1-2 J40: 1-2 J44: 5-6 and 3-4 J42: 1-2 J5: 3-4 and 5-6 J45: 1-2 (for bipolar signal or open for unipolar signal) J46: 1-2 (for bipolar signal or open for unipolar signal)

Table 6. Analog Input Configurations (CH0–CH5) (continued)

CONFIGURATION		ADC INPUT CONFIGURATION	INPUT CONNECTORS	JUMPER POSITIONS
NO.	DESCRIPTION			
8	MAX9632, Channel 3	Inverting, differential, second-order LPF	AIN3.1- (or TP56): AIN3.1- and AGND AIN3.3- (or TP60): AIN3.3- and AGND	J39: 3-4 J43: 1-2 and 7-8 J41: 3-4 J40: 3-4 J44: 1-2 and 7-8 J42: 3-4 J5: 3-4 and 5-6 J45: 1-2 (for bipolar signal or open for unipolar signal) J46: 1-2 (for bipolar signal or open for unipolar signal)
9	MAX9632, Channel 3	Noninverting, differential, first-order LPF	AIN3.2+ (or TP59): AIN3.2+ and AGND AIN3.4+ (or TP63): AIN3.4+ and AGND	J43: 7-8 and 3-4 J41: 1-2 J44: 7-8 and 3-4 J42: 1-2 J5: 3-4 and 5-6 J45: 1-2 (for bipolar signal or open for unipolar signal) J46: 1-2 (for bipolar signal or open for unipolar signal)
10	MAX9632, Channel 3	Inverting, differential, first-order LPF	AIN3.2- (or TP58): AIN3.2- and AGND AIN3.4- (or TP62): AIN3.4- and AGND	J43: 7-8 and 3-4 J41: 3-4 J44: 7-8 and 3-4 J42: 3-4 J5: 3-4 and 5-6 J45: 1-2 (for bipolar signal or open for unipolar signal) J46: 1-2 (for bipolar signal or open for unipolar signal)
11	MAX44205, Channel 4	Differential, first-order LPF	J48: AIN4- (or TP73): AIN4- and AGND J47: AIN4+ (or TP72): AIN4+ and AGND	J6: 3-4 and 5-6 J49: open
12	MAX44205, Channel 5	Differential, first-order LPF	AIN5+ (or TP74): AIN5+ and AGND AIN5- (or TP75): AIN5- and AGND	J7: 3-4 and 5-6 J50: open

Sync Input and Sync Output (For Coherent Sampling)

Sync Input and Sync Output is applicable to the FPGA (ZedBoard) and is not used in Standalone mode. The SYNC_IN SMA accepts an approximate 100MHz waveform signal to generate the system clock of the ZedBoard. For maximum performance, use a low-jitter clock that syncs to the user's analog function generator. The SYNC_OUT SMA outputs a 10MHz square waveform that syncs to the user's analog function generator. Both options are used for coherent sampling of the IC. Use only one option at a time. The relationship between f_{IN} , f_S , N_{CYCLES} , and $M_{SAMPLES}$ is given as follows:

$$\frac{f_{IN}}{f_S} = \frac{N_{CYCLES}}{M_{SAMPLES}}$$

where:

f_{IN} = Input frequency

f_S = Sampling frequency

N_{CYCLES} = Prime number of cycles in the sampled set

$M_{SAMPLES}$ = Total number of samples

Ordering Information

PART	TYPE
MAX11253EVKIT#	EVKIT
MAX11254EVKIT#	EVKIT

#Denotes RoHS compliant.

Contact Avnet to purchase a ZedBoard to communicate with the MAX11253/MAX11254 EV kit.

This EV kit comes with two assembly options:

The MAX11253EVKIT# comes with a MAX11253ATJ+ in a 32-pin TQFN package.

The MAX11254EVKIT# comes with a MAX11254ATJ+ in a 32-pin TQFN package..

Both EV kit variations use the same PCB and bill of materials, and the only variation is the IC assembled at U1.

MAX1153/MAX11254 Family EV Kit Bill of Materials

ITEM	QTY	REF DES	MFG PART #	MFG	VALUE	COMMENTS
1	32	TP13, TP15-TP18, TP20, TP22, TP27, TP29, TP31, TP33, TP35-TP37, TP46, TP52-TP54, TP64, TP65, TP70, TP71, TP76, TP80, TP82, TP85, TP87, TP89, TP93-TP95, GND_FPGA	5001 TDK	TDK	N/A	
2	63	C1-C3, C7-C9, C19, C21-C23, C27, C28, C31, C33, C40, C41, C44, C45, C52, C53, C56, C57, C64, C65, C68, C69, C76, C77, C80-C84, C95, C96, C99, C100, C116-C118, C121, C122, C125, C128, C129, C132, C135, C137-C143, C146, C147, C155, C166-C168, C176, C184, C187	C1608X7R1H104K080AA	TDK	0.1UF	
3	41	C4-C6, C20, C26, C29, C30, C38, C39, C42, C43, C50, C51, C54, C55, C62, C63, C66, C67, C74, C75, C78, C79, C93, C94, C97, C98, C113, C114, C119, C120, C123, C124, C144, C145, C152-C154, C173, C174, C186	UMK107AB7105KA	TAIYO YUDEN	1UF	
4	6	C10-C15	C1608C0G2A332J080AA	TDK	3300PF	
5	11	C16-C18, C32, C150, C157, C158, C163, C164, C169, C170	C2012X7R1E475K125AB	TDK	4.7UF	
6	3	C24, C126, C127	C0603C102K1GAC	KEMET	1000PF	
7	28	C25, C34-C37, C46-C49, C58-C61, C70-C73, C156, C159, C162, C165, C171, C172, C175, C177-C179, C185	C1608C0G1H103J080AA	TDK	0.01UF	
8	8	C85-C92	C1608C0G1H47ZJ080AA	TDK	4700PF	
9	4	C115, C130, C131, C136	C1608X5R1E475K080AC	TDK	4.7UF	
10	2	C133, C134	C0603HQM101-180FNP	KEMET/MENKEL	18PF	
11	9	C148, C149, C160, C161, C180-C183, C188	C2012X5R1V106K085	TDK	10UF	
12	1	C151	GRM188R71E474KA12	MURATA	0.47UF	
13	1	D1	MBR0520L	FAIRCHILD SEMICONDUCTOR	MBR0520L	
14	2	D2, D3	BAS4002A-RPP	INFINEON	BAS4002A-RPP	
15	2	DS1, DS2	LGL29K-G2J1-24-Z	OSRAM	LGL29K-G2J1-24-Z	
16	1	DS3	LS L29K-G1J2-1-Z	OSRAM	LS L29K-G1J2-1-Z	
17	3	J1, J25, J26	1282834-0	TYCO ELECTRONICS	1282834-0	
18	2	J2, J3	282834-4	TYCO ELECTRONICS	282834-4	
19	4	J4-J7	PEC04DAAN	SULLINS ELECTRONICS CORP.	PEC04DAAN	
20	1	J8	PCC02SAAN	SULLINS	PCC02SAAN	
21	9	J10-J13, J16, J17, J24, J52, J65	PCC03SAAN	SULLINS	PCC03SAAN	
22	10	J27-J30, J47, J48, J54, J56-J58	5-1814832-1	TYCO	5-1814832-1	
23	11	J31-J34, J39-J42, J66-J68	PBC02DAAN	SULLINS ELECTRONIC CORP.	PBC02DAAN	
24	4	J35, J36, J43, J44	PBC04DAAN	SULLINS ELECTRONICS CORP.	PBC04DAAN	
25	2	J49, J50	PEC02DAAN	SULLINS ELECTRONIC CORP.	PEC02DAAN	
26	1	J51	PBC10SAAN	SULLINS ELECTRONICS CORP.	PBC10SAAN	
27	1	J53	ASP-134604-01	SAMTEC	ASP-134604-01	
28	1	J59	10118192-0001LF	FCI CONNECT	10118192-0001LF	MICRO-USB
29	1	J61	KLDX-0202-B	KYCON	KLDX-0202-B	

MAX1153/MAX11254 Family EV Kit Bill of Materials (continued)

ITEM	QTY	REF DES	REF ITEM	MFG PART #	MFG	VALUE	COMMENTS
30	1	J62		282834-2	TE CONNECTIVITY	282834-2	
31	1	J69		PEC03DAAN	SULLINS ELECTRONICS	PEC03DAAN	
32	1	JMP1		22-28-4043	MOLEX	22-28-4043	
33	1	L1		MMZ1608B601C	TDK	600	
34	4	L2-L5		XPL2010-333ML	COILCRAFT	33UH	
35	4	R1-R4		RN73C1J49R9B; 9-1614353-1	TE CONNECTIVITY	49.9	
36	12	R5, R8-R14, R52, R53, R93, R94		RN73C1J10RBTG; 1614350-2	TE CONNECTIVITY	10	
37	1	R6		CRCW0603237KFK;	VISHAY	237K	
38	6	R7, R197, R199, R201, R203, R205		ERJ3EKF2373V	DALE/PANASONIC	73.2K	
39	14	R15, R171, R172, R175-R179, R181-R186		CRCW06031000FK;	PANASONIC	10K	
40	6	R16, R17, R162, R164, R166, R167		9C06031A1002FK; ERJ-3EKF1002V	VISHAY DALE/PANASONIC	10K	
41	3	R18, R19, R195		CRCW060349R9FK	VISHAY DALE/PANASONIC	1K	
42	16	R20-R27, R54-R61		CRCW06031M00FK;	DALE/PANASONIC	1M	
43	40	R104		MCR03EZPFX1004	VISHAY DALE/ROHM	1K	
44	12	R36-R39, R50, R51, R70-R72, R80, R91, R92		RG1608N-102-B-T1	SUSUMU CO LTD.	1K	
45	4	R44, R45, R85, R86		CR0603-16W-000T; CR0603-16W-000RJT	VENKEL LTD.	0	
46	44	R73-R79, R105, R111-R117, R139-R161, R168, R169, R187-R190		TNPW06031K50BE; ERA-3YEB152V	PANASONIC	1.5K	
47	2	R95, R96		ERJ-3EKF28R0V	PANASONIC	28	
48	2	R163, R165		TNPW060310K0BE;	VISHAY DALE/KOA	10K	
49	1	R170		RN731JTTD1002B	SPEER ELECTRONICS	15K	
50	1	R173		CRCW06030000ZS;	VISHAY DALE	15K	
51	1	R174		MCR03EZPJ000; ERJ-3GEY0R00V	VISHAY DALE	2.2K	
52	1	R180		CRCW060315K0FK	VISHAY DALE	12K	
53	2	R191, R194		CRCW06032K20FK	VISHAY DALE	4.7K	
54	1	R192		CRCW06034K70FK	VISHAY DALE	20K	
55	1	R193		PANASONIC;CRCW06032002FK; MCR03EZPFX2002;ERJ-3EKF2002V	VISHAY DALE/ROHM	750K	
56	1	R196		CRCW0603750KFK	VISHAY DALE	165K	
57	2	R198, R200		CRCW0603165KFK	VISHAY DALE	38.3K	
58	1	R202		ERJ-3EKF3832	PANASONIC	1681K	
59	1	R204		ERJ3EKF6813V	PANASONIC	10	
60	49	SU1-SU49		CRCW060310R0FK;	VISHAY DALE/ROHM	124K	
61	1	T1		MCR03EZPFX10R0	VISHAY DALE	SX1100-B	
62	58	TP1-TP12, TP14, TP19, TP21, TP23-TP26, TP30, TP38-TP45, TP48-TP51, TP56-TP63, TP66-TP69, TP72-TP75, TP77-TP79, TP81, TP84, TP86, TP91, TP92,5V_TTL		CRCW0603124KFK	KYCON	TGM-H240V8LF	
				SX1100-B	HALO ELECTRONICS, INC	N/A	
				TGM-H240V8LF	INC	5000?	

MAX11253/MAX11254 Family
Evaluation Kit

Evaluates: MAX11253/MAX11254

MAX1153/MAX11254 Family EV Kit Bill of Materials (continued)

ITEM	QTY	REF DES	MFG PART #	MFG	VALUE	COMMENTS
63	5	TP28, TP83, TP88, TP90, TP96		5004 ?	N/A	
64	1	U1	MAX11254ATJ+	MAXIM	MAX11254ATJ+	
65	1	U5	MAX14935CAWE+	MAXIM	MAX14935CAWE+	MAX14931TCASE +
66	1	U6	MAX14935CAWE+	MAXIM	MAX14935CAWE+	
67	1	U7	MAX6070AAUT18+	MAXIM	MAX6070AAUT18+	
68	1	U8	MAX6070AAUT30+	MAXIM	MAX6070AAUT30+	
69	1	U9	MAX6126AASA30+	MAXIM	MAX6126AASA30	
70	1	U10	LTC6930HDCB-8.19	LINEAR TECHNOLOGY	LTC6930HDCB-8.19	
71	8	U11-U18	MAX9632AUA+	MAXIM	MAX9632AUA+	
72	2	U19, U20	MAX44205	MAXIM	MAX44205	
73	2	U21, U22	74LVC2G125DP	?	74LVC2G125DP	
74	2	U23, U24	93LC66BT-IOT	MICROCHIP	93LC66BT-IOT	
75	1	U25	FT2232HL	FUTURE TECHNOLOGY DEVICES INTL L.TD.	FT2232HL	
76	2	U26, U35	MAX15006BATT+	MAXIM	MAX15006BATT+	
77	1	U27	MAX16910CATA9+	MAXIM	MAX16910CATA9+	
78	1	U28	MAX13256ATB+	MAXIM	MAX13256ATB+	
79	1	U29	MAX15006CATT+	MAXIM	MAX15006CATT+	
80	1	U30	MAX8840ELT18+	MAXIM	MAX8840ELT18+	MAX8840ELT18+
81	3	U31, U33, U34	TPS7A3001DGN	TEXAS INSTRUMENTS	TPS7A3001DGN	
82	1	U32	TPS7A4901DGN	TEXAS INSTRUMENTS	TPS7A4901DGN	
83	1	U36	MAX15006AATT+	MAXIM	MAX15006AATT+	
84	1	Y1	ABM7-12.000MHZ-D2Y-T	ABRACON	12MHZ	
85	1	PCB	EPCB11254	MAXIM	PCB	

MAX11253/MAX11254 Family Evaluation Kit

Evaluates: MAX11253/MAX11254

MAX1153/MAX11254 Family EV Kit PCB Layout Diagrams

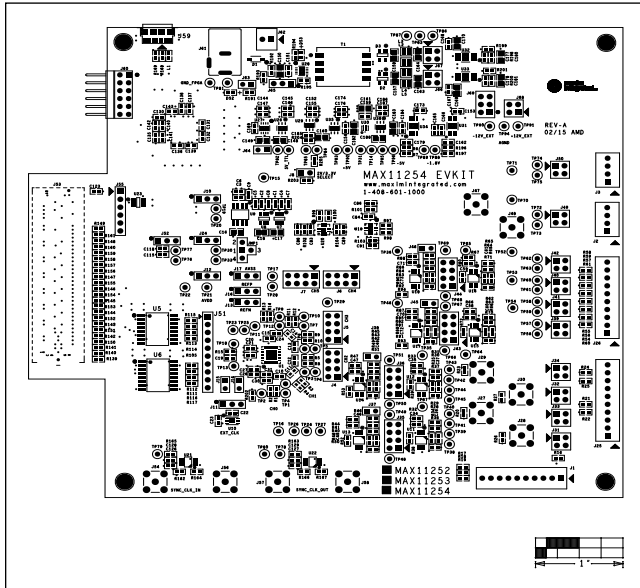

MAX1153/MAX11254 Family EV Kit—Top Silkscreen

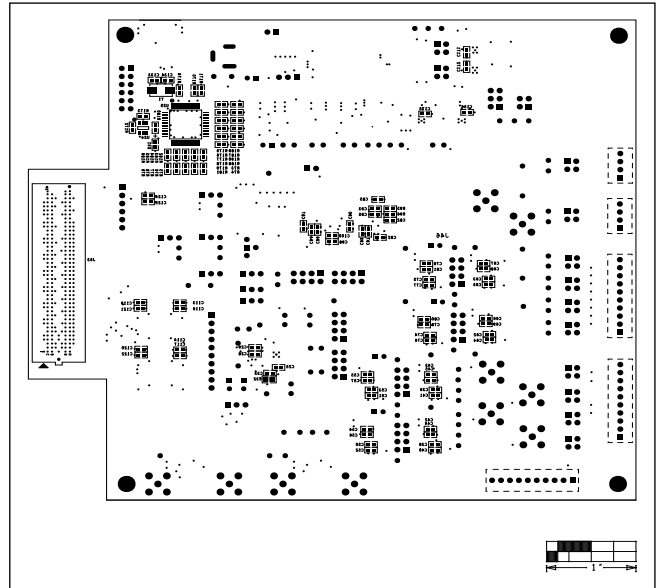

MAX1153/MAX11254 Family EV Kit—Bottom Silkscreen

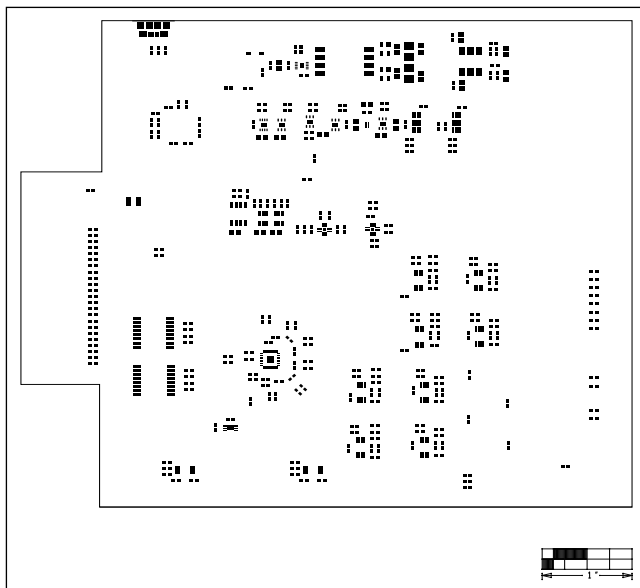

MAX1153/MAX11254 Family EV Kit—Top Paste

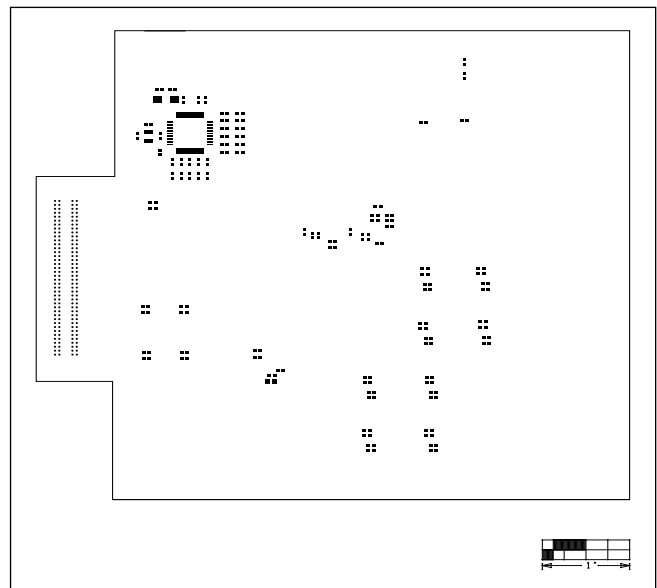

MAX1153/MAX11254 Family EV Kit—Bottom Paste

MAX11253/MAX11254 Family EV Kit PCB Layout Diagrams (continued)

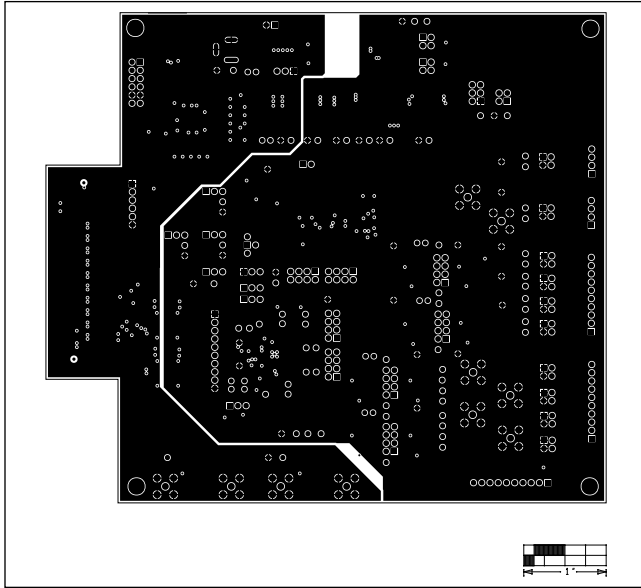

MAX11253/MAX11254 Family EV Kit—Internal 2

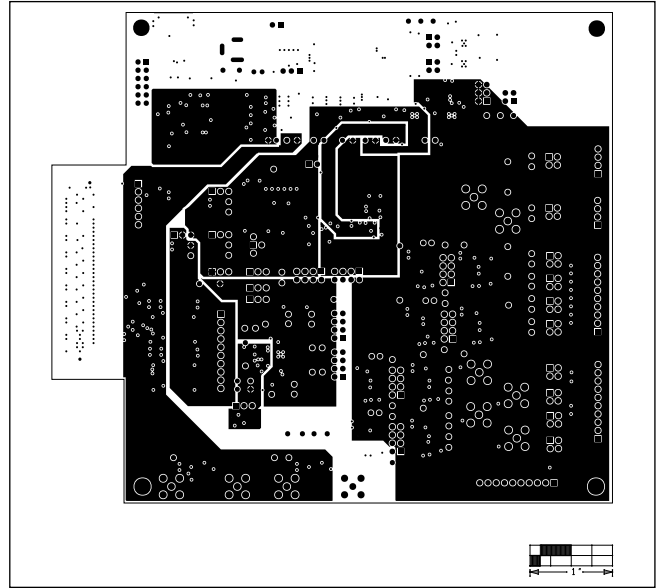

MAX11253/MAX11254 Family EV Kit —Internal 3

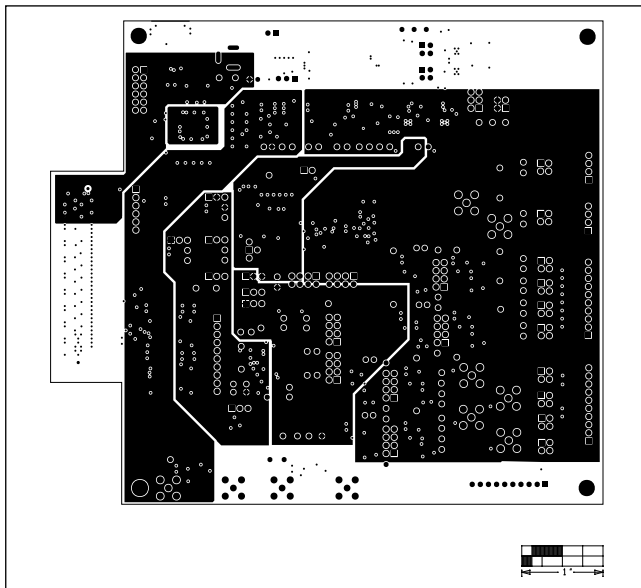

MAX11253/MAX11254 Family EV Kit—Internal 4

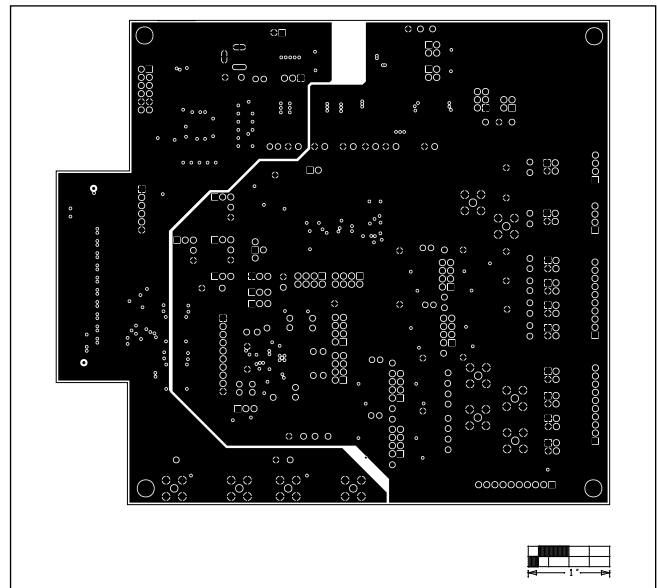

MAX11253/MAX11254 Family EV Kit—Internal 5

MAX1153/MAX11254 Family EV Kit PCB Layout Diagrams (continued)

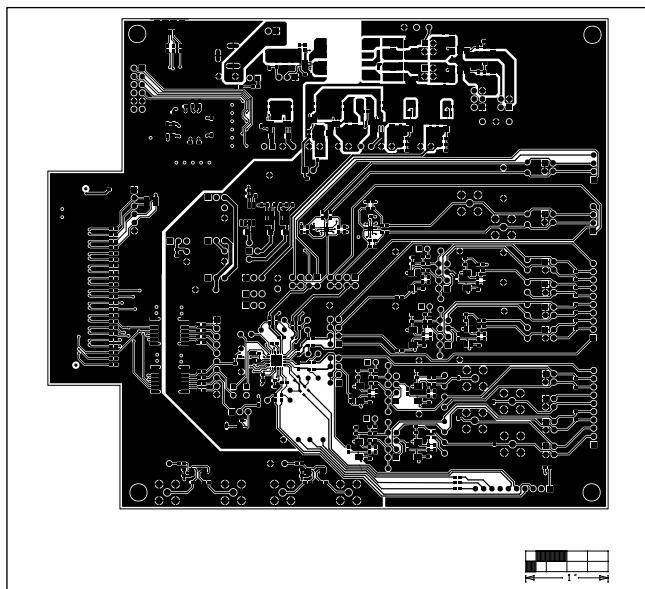

MAX1153/MAX11254 Family EV Kit—Top

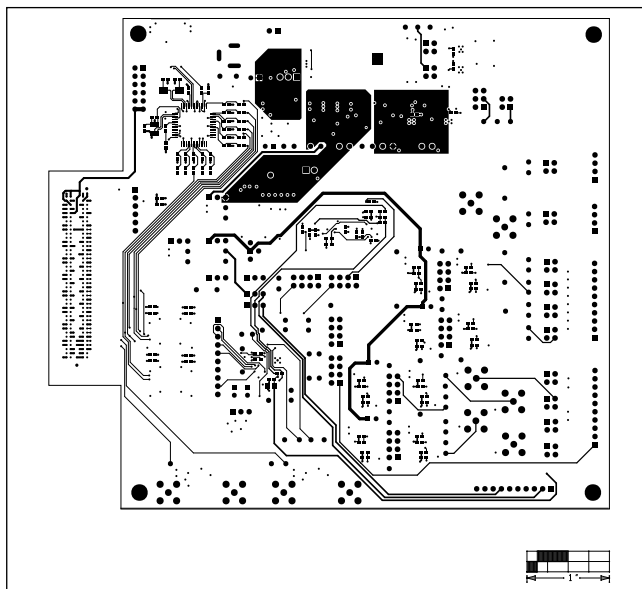

MAX1153/MAX11254 Family EV Kit—Bottom

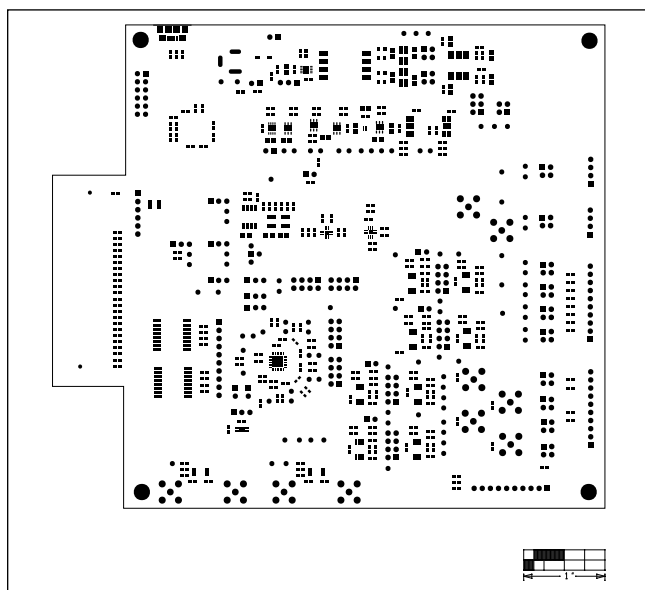

MAX1153/MAX11254 Family EV Kit—Top Mask

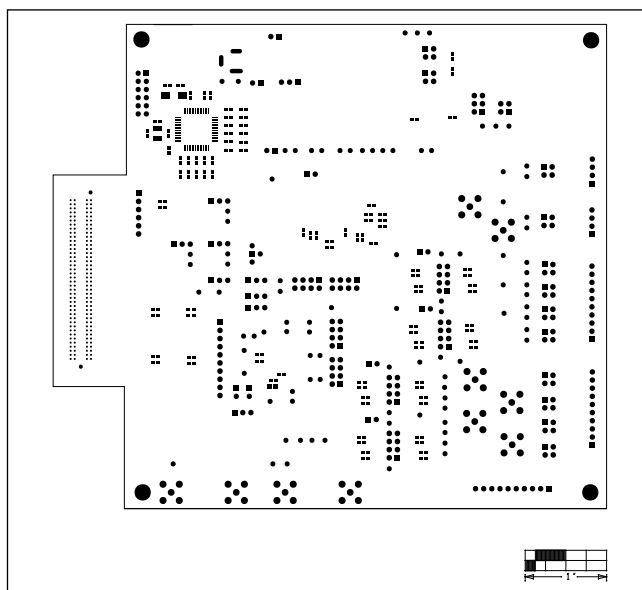

MAX1153/MAX11254 Family EV Kit—Bottom Mask

MAX11253/MAX11254 Family EV Kit Schematic

ALL INPUTS +/- 3V MAX

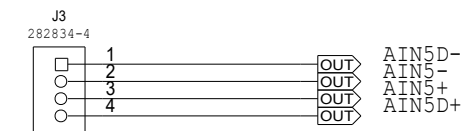
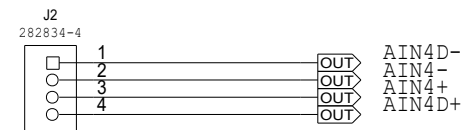
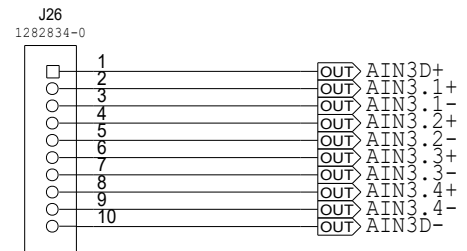
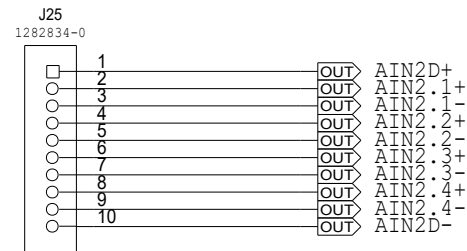
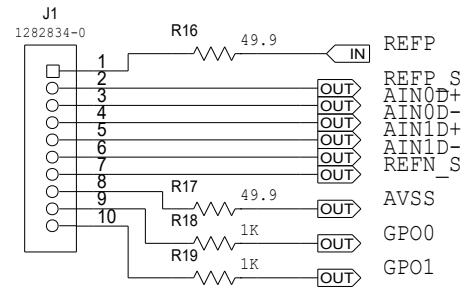

MAX11253/MAX11254 Family EV Kit Schematic (continued)

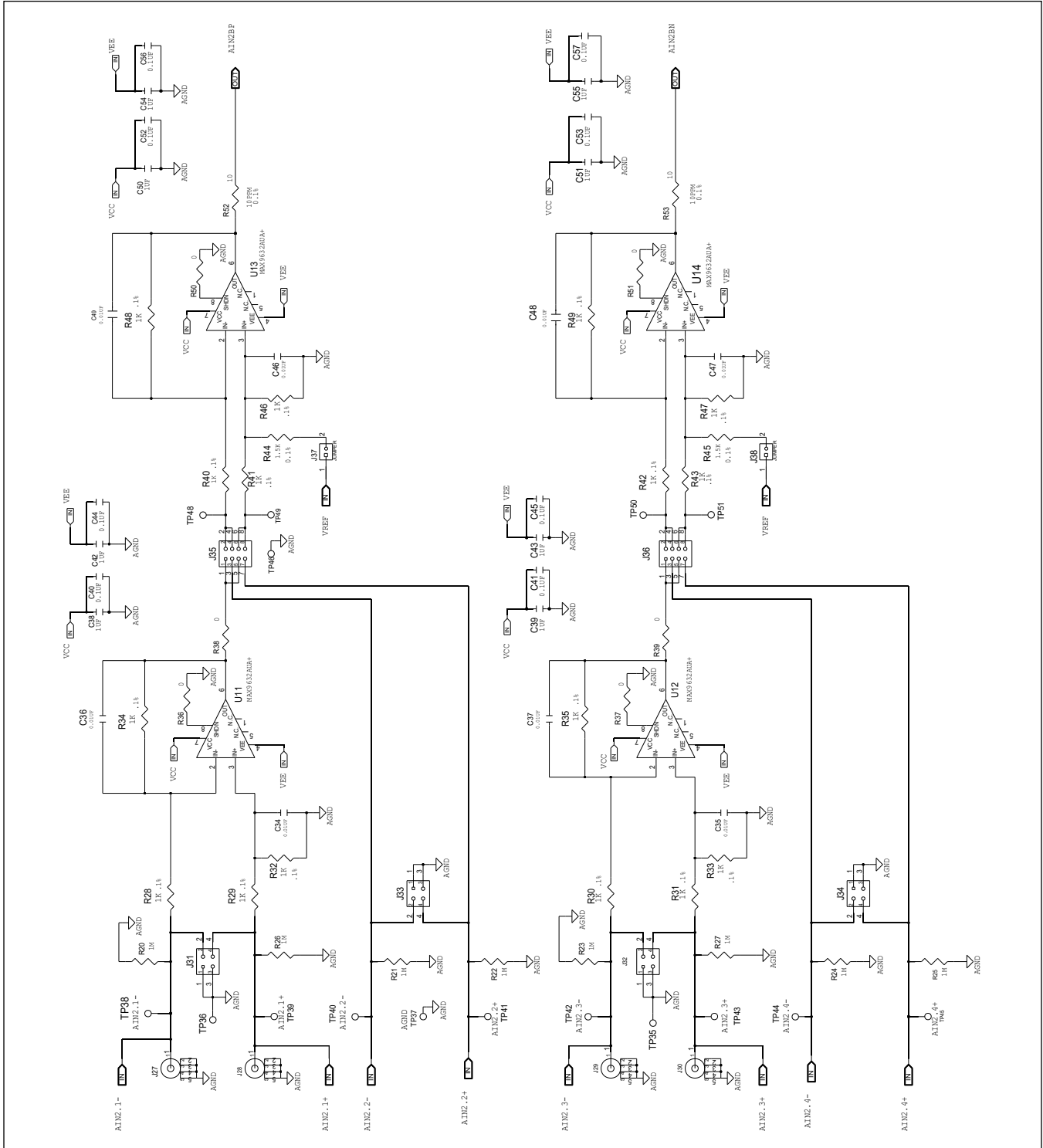

MAX11253/MAX11254 Family EV Kit Schematic (continued)

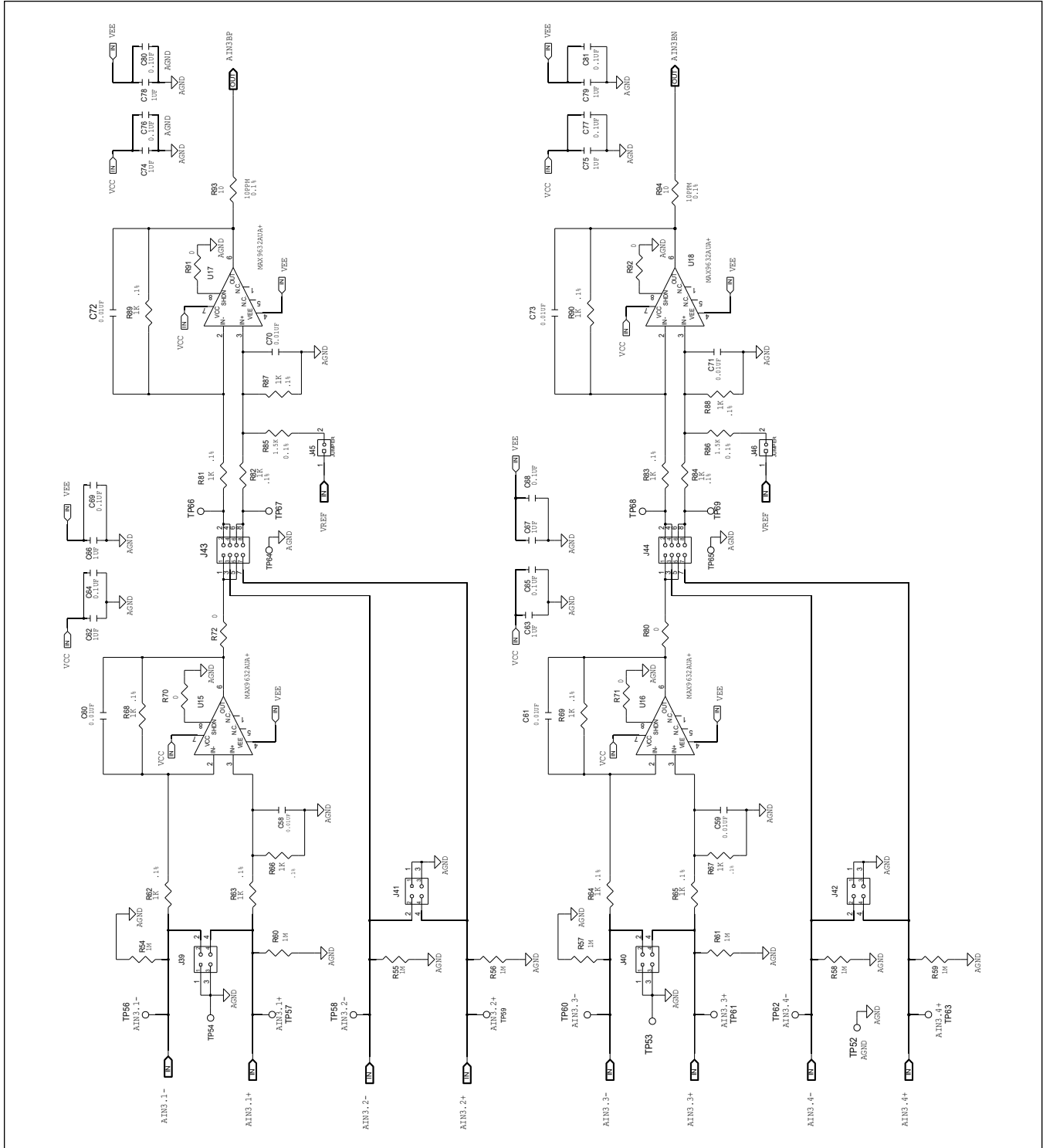

MAX1153/MAX11254 Family EV Kit Schematic (continued)

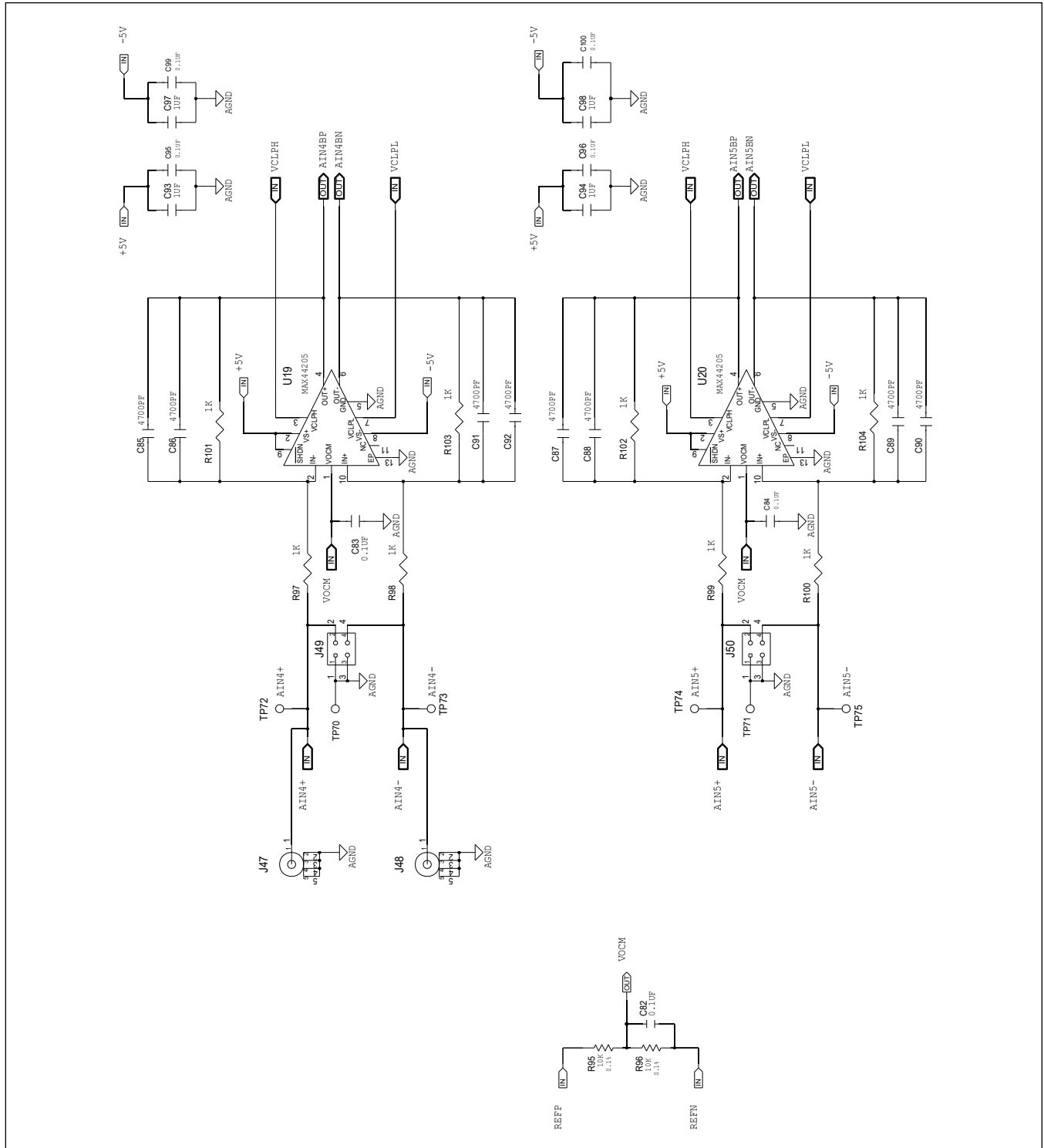

MAX11253/MAX11254 Family Evaluation Kit

Evaluates: MAX11253/MAX11254

MAX11253/MAX11254 Family EV Kit Schematic (continued)

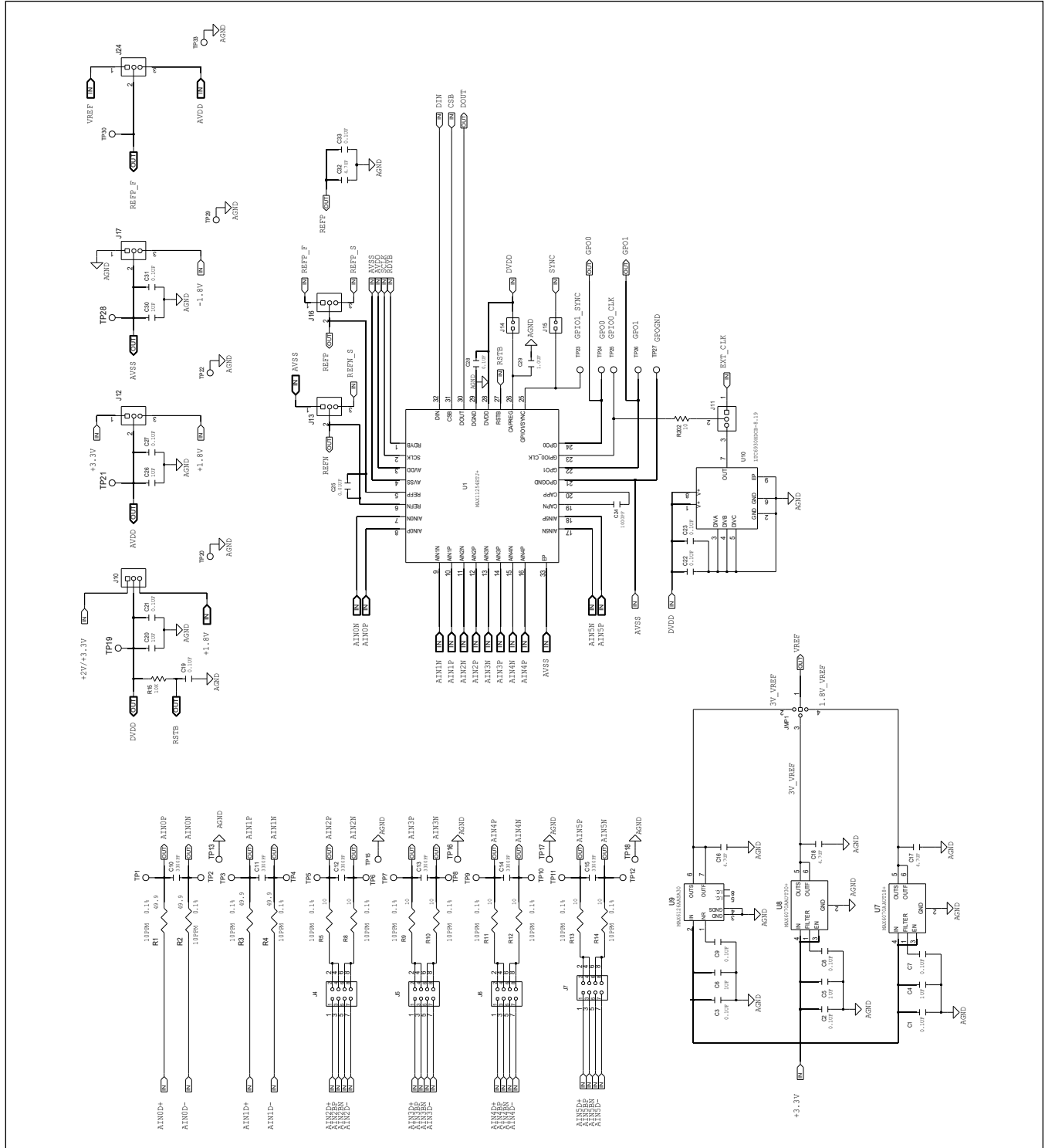

MAX1153/MAX11254 Family EV Kit Schematic (continued)

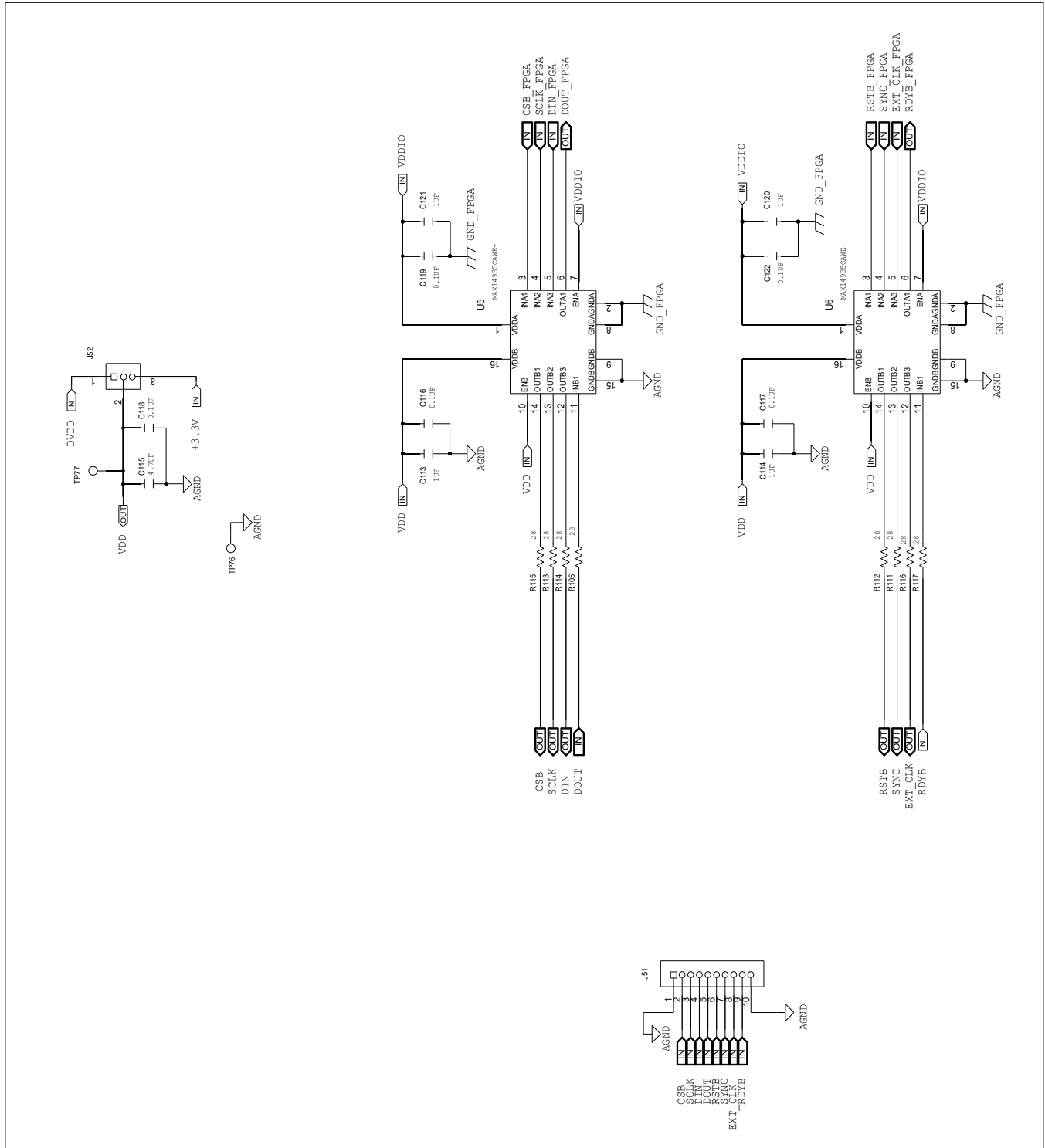

MAX11253/MAX11254 Family Evaluation Kit

Evaluates: MAX11253/MAX11254

MAX11253/MAX11254 Family EV Kit Schematic (continued)

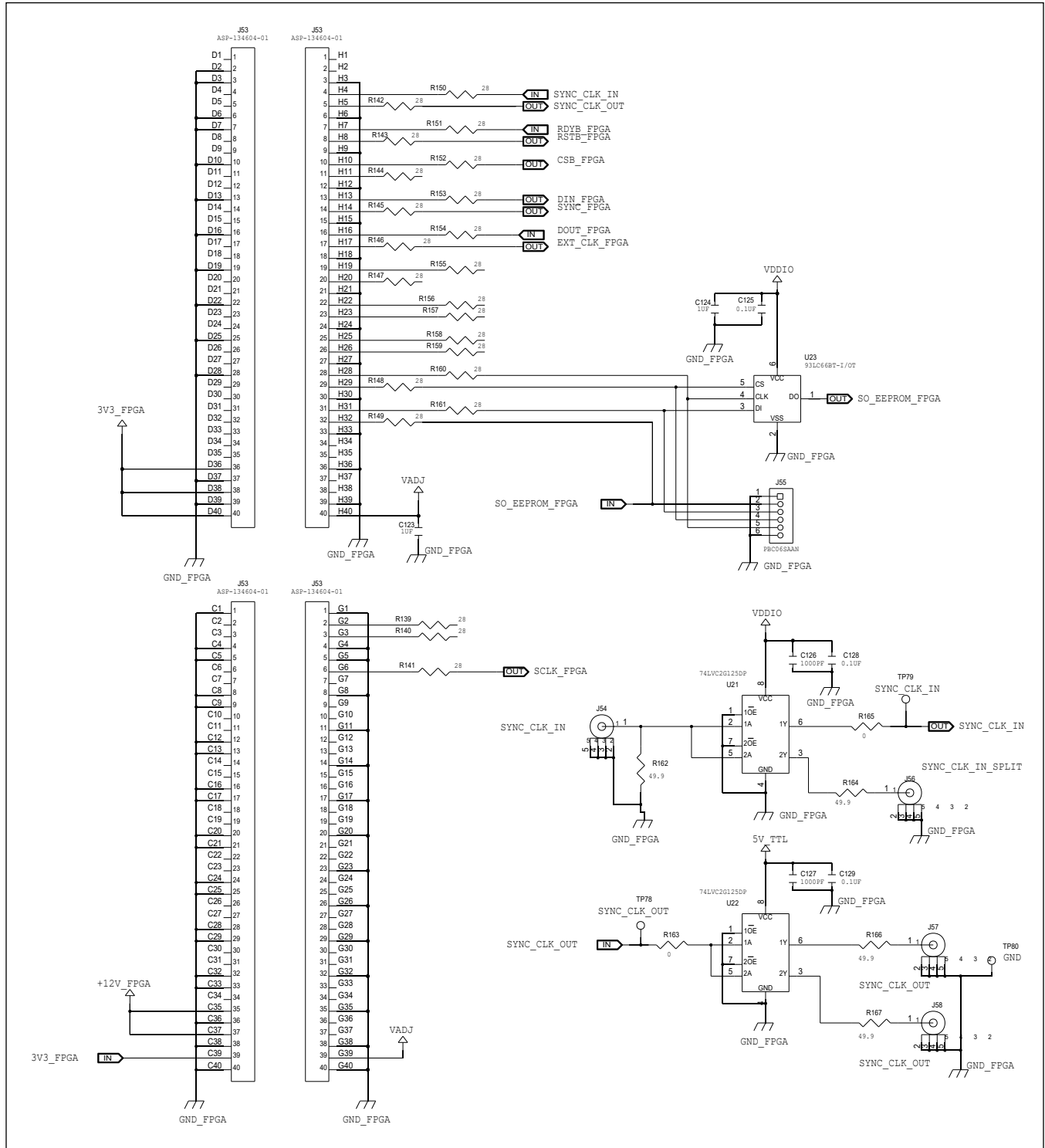

MAX11253/MAX11254 Family EV Kit Schematic (continued)

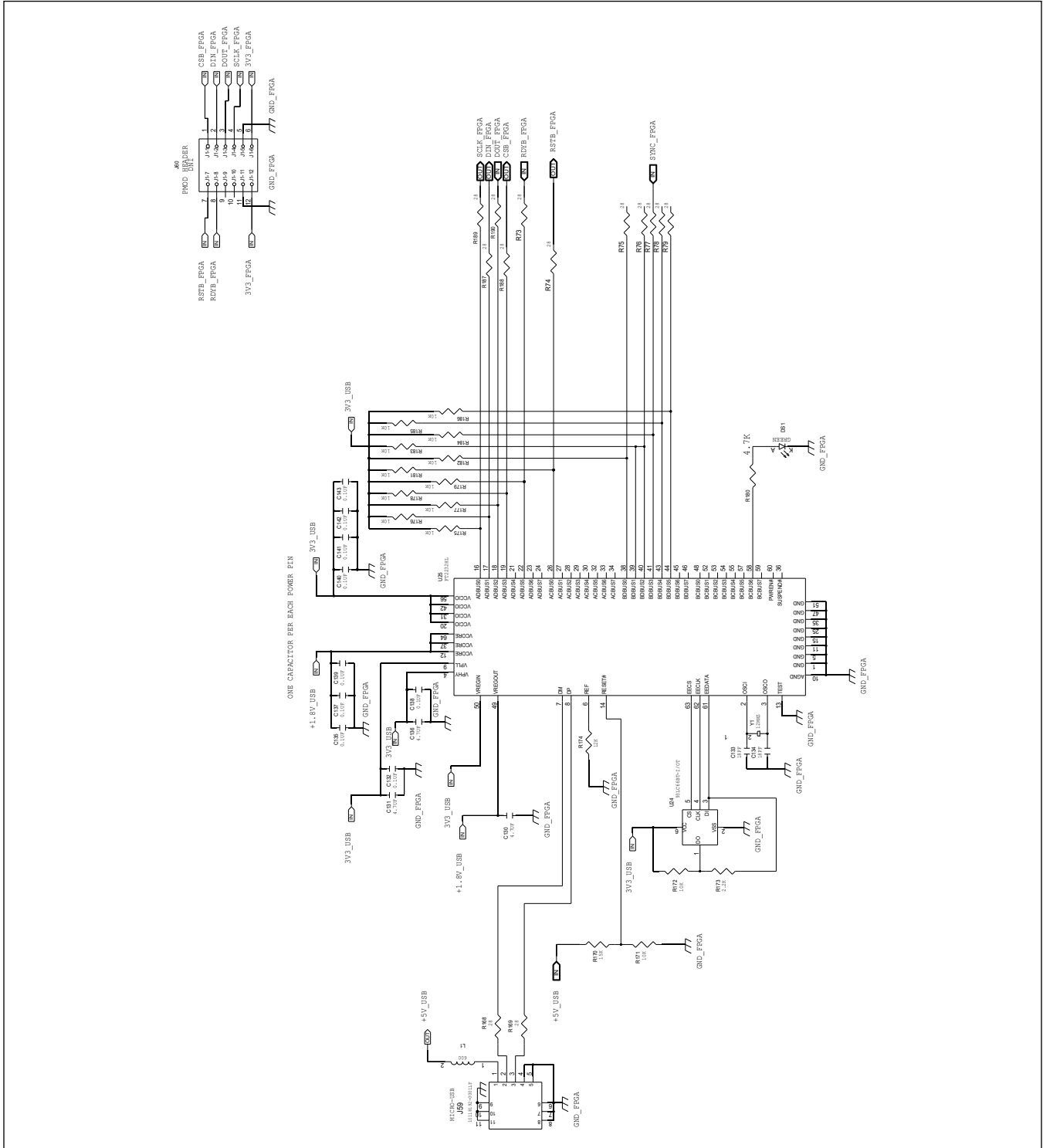

MAX11253/MAX11254 Family Evaluation Kit

Evaluates: MAX11253/MAX11254

MAX1153/MAX11254 Family EV Kit Schematic (continued)

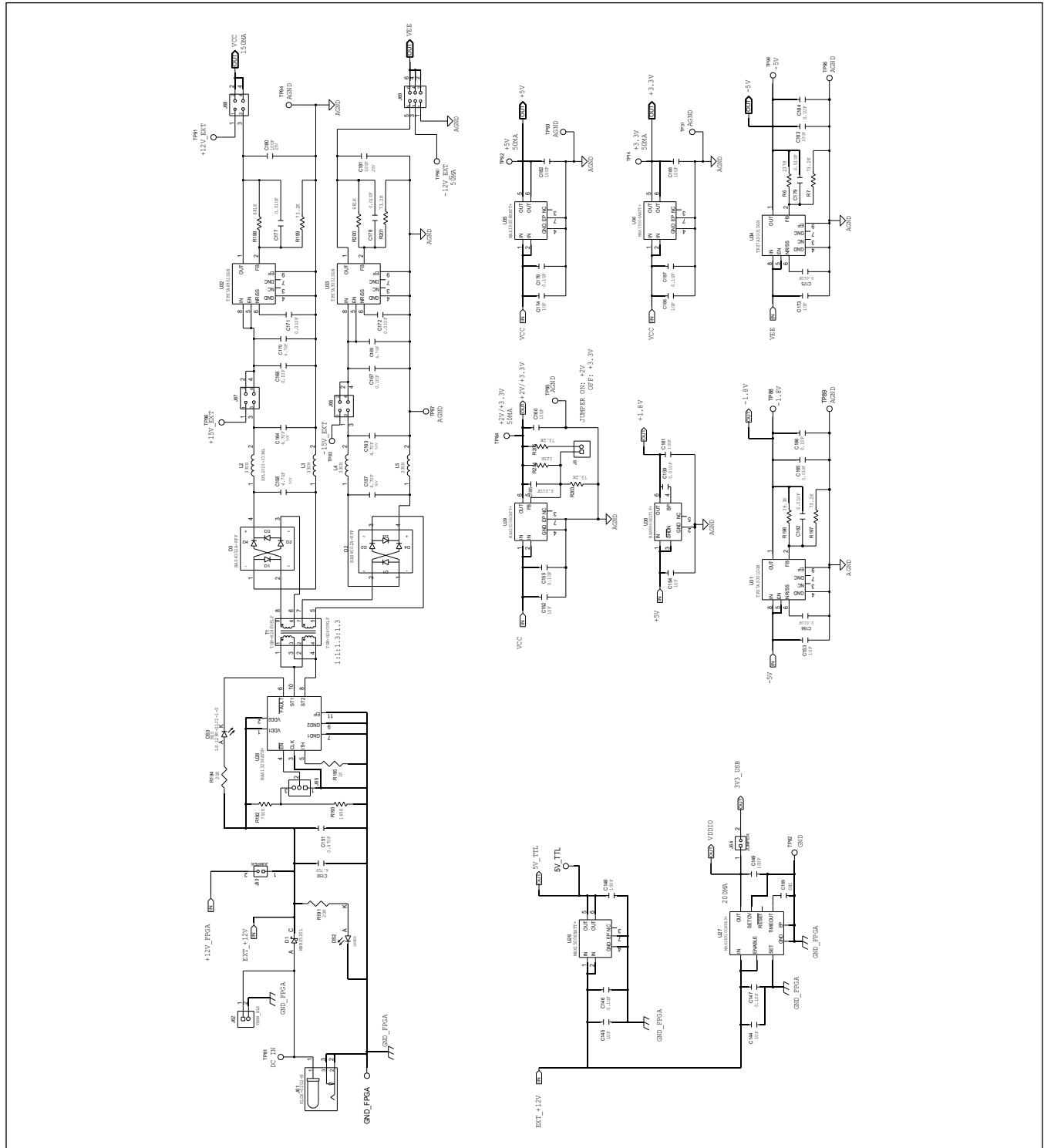

Revision History

REVISION NUMBER	REVISION DATE	DESCRIPTION	PAGES CHANGED
0	4/15	Initial release	—
1	5/15	Added the MAX11253 EV kit to data sheet	1-22
2	4/18	Updated PCB layout diagrams, schematic, and bill of materials	21-35

For pricing, delivery, and ordering information, please contact Maxim Direct at 1-888-629-4642, or visit Maxim Integrated's website at www.maximintegrated.com.

Maxim Integrated cannot assume responsibility for use of any circuitry other than circuitry entirely embodied in a Maxim Integrated product. No circuit patent licenses are implied. Maxim Integrated reserves the right to change the circuitry and specifications without notice at any time.

X-ON Electronics

Largest Supplier of Electrical and Electronic Components

Click to view similar products for [Data Conversion IC Development Tools](#) category:

Click to view products by [Maxim](#) manufacturer:

Other Similar products are found below :

[EVAL-AD7265EDZ](#) [EVAL-AD7719EBZ](#) [EVAL-AD7767-1EDZ](#) [EVAL-AD7995EBZ](#) [AD9211-200EBZ](#) [AD9251-20EBZ](#) [AD9251-65EBZ](#)
[AD9613-170EBZ](#) [AD9629-20EBZ](#) [AD9716-DPG2-EBZ](#) [AD9737A-EBZ](#) [AD9993-EBZ](#) [DAC8555EVM](#) [EVAL-AD5061EBZ](#) [EVAL-](#)
[AD5062EBZ](#) [EVAL-AD5443-DBRDZ](#) [EVAL-AD5570SDZ](#) [EVAL-AD7992EBZ](#) [EVAL-AD7994EBZ](#) [AD9119-MIX-EBZ](#) [AD9233-125EBZ](#)
[AD9629-80EBZ](#) [AD9650-80EBZ](#) [AD9767-EBZ](#) [DAC8531EVM](#) [LM96080EB/NOPB](#) [EVAL-AD5445SDZ](#) [EVAL-AD5660EBZ](#) [EVAL-](#)
[AD7685SDZ](#) [EVAL-AD7687SDZ](#) [MAX5318PMB#](#) [MAX1246EVL11-QSOP](#) [MAX117EVKIT-DIP](#) [DC2365A-C](#) [DC2795A-B](#) [DC2795A-A](#)
[DAC088S085EB/NOPB](#) [SIM8909-EVB-KIT](#) [82635ASRCDVKHV 961443](#) [DC1466B-B](#) [EVAL-AD5413SDZ](#) [ADC12D1600RB/NOPB](#) [1083](#)
[RFPDK FOR CMT2X5X](#) [TS7003DB](#) [TSC2014EVM-PDK](#) [MOD-USB3G](#) [KDC5514EVALZ](#) [650201392G](#) [ISL28005FH-100EVAL1Z](#)