

General Description

The MAX11312PMB# peripheral module (Pmod™) provides the necessary hardware to interface the MAX11312 12-channel programmable mixed-signal I/O device to any system that utilizes Pmod-compatible expansion ports configurable for I²C communication. The device is a 12-bit multichannel analog-to-digital converter (ADC) and a 12-bit buffered DAC output in a single IC. This device also includes software-configurable general-purpose I/O ports. A local and two remote temperature sensors keep track of junction and environmental temperatures. Adjacent pairs of ports can also be used as logic translator or analog switch. Each pin can also be used as a positive input of a comparator with programmable threshold.

Refer to the MAX11312 IC data sheet for detailed information regarding operation of the device and the USB2PMB2 (Munich) adapter board data sheet for detailed information regarding the Munich board and GUI. Refer to the MAX11312 peripheral module and Munich adaptor board *Quick Start Guide* for step-by-step evaluation instructions. Refer to the MAX11312 Configuration Software User Guide for detailed information using the design tool.

Features

- Up to 12 12-Bit ADC Programmable Inputs
- Up to 12 12-Bit DACs with 25mA Current Capability
 - 70mA max at +12V with On-Board Power Supply
 - 30mA (typ) at -12V with On-Board Power Supply
 - Use External Power Supply at VDDIO (VDDIO Jumper Removed) if More Current is Needed
- Up to 12 Digital I/Os
- Up to 12 Comparator Inputs
- Internal or External Reference for ADC and DAC
- Individually Selectable ADC References for Each Port
- Internal Temperature Sensor (-40°C to +125°C, ±3°C Accuracy)
- Two Remote Temperature-Measurement Controllers (-40°C to +150°C, ±3°C Accuracy)
- 2 x 6-Pin Pmod-Compatible Connector (I²C)
- RoHS Compliant
- Proven PCB Layout
- Fully Assembled and Tested

Ordering Information appears at end of data sheet.

Peripheral Module Board Photo

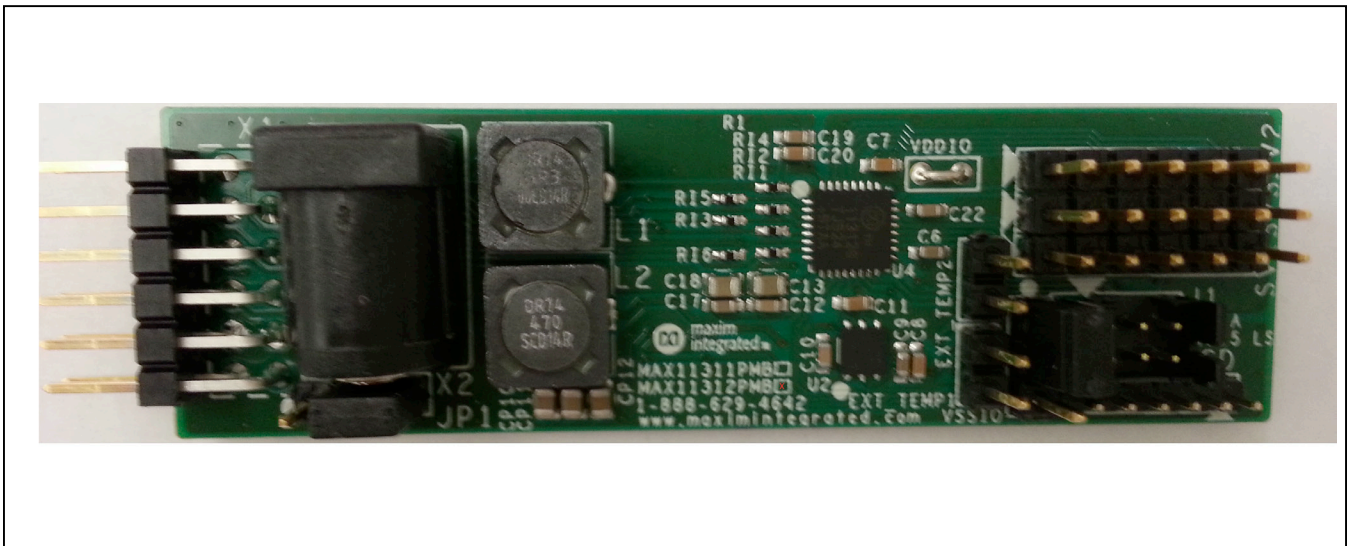

Pmod is a trademark of Digilent Inc.

Detailed Description

I²C Interface

The MAX11312PMB# Pmod can plug directly into a Pmod-compatible port (configured for I²C) through the X1 connector. For information on the I²C protocol, refer to the MAX11312 IC data sheet.

- Connector X1 provides connection of the module to the Pmod host. See [Table 1](#) and [Figure 1](#) for detailed description.
- Connector JP1 provides selection of +3.3V either from the PMOD_SUPPLY or an external supply (X2).
- Connectors SV1 and SV2 provide connection to the IC pins (MAX11312 ports 0–11). Connector SV3 is ground.
- Connectors EXT_TEMP1 and EXT_TEMP2 provide connection to the external temperature sensors.
- Connector VDDIO provides connection to the AVDDIO pins of the device, which is connected to the +12V power supply
- Connector VSSIO provides connection to the AVSSIO pins of the device, which is the analog negative supply for mixed-signal ports. Install the VSSIO jumper from 1 to 2 to connect AVSSIO to ground. Install VSSIO from 2 to 3 to connect AVSSIO to -12V.

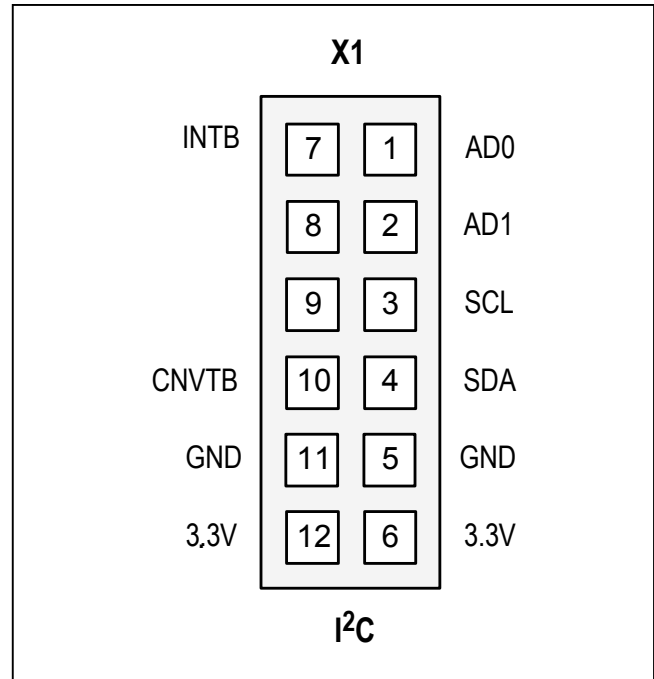

Figure 1. X1: Pmod I²C Connector Pin Configuration

Table 1. Connector X1 (I²C Communication)

PIN	SIGNAL	DESCRIPTION
1	AD0	MAX11312 Slave Address Bit 0
2	AD1	MAX11312 Slave Address Bit 1
3	SCL	MAX11312 Serial Interface Clock Input
4	SDA	MAX11312 Serial Interface Input and Output
5, 11	GND	Ground
6, 12	+3.3V	+3.3V Power Supplies
7	INTB	Interrupt Open-Drain Output. Asserted low when the MAX11312 issues an interrupt.
8	—	No Connection
9	—	No Connection
10	CNVTB	ADC Conversion Control Input. Assert low to initiate an ADC conversion.

Default Jumper Setting

Verify that all jumpers are in their default positions, as follows:

- 1) Jumper VDDIO: Connect from VDDIO to +12V.
- 2) Jumper VSSIO: Connect from VSSIO to GND.
- 3) Jumpers EXT_TEMP1 and EXT_TEMP2: Open.
- 4) Jumper JP1: Connect PMOD_SUPPLY to +3.3V, JP1-1 to JP1-2.

Power Supplies

The Pmod contains the MAX8752 step-up DC-DC converter (U3), which upconverts the +3.3V power supply from the Pmod X1 connector to +13V. The MAX5084 (U2) linear regulator then regulates the +13V input to +5V output voltage, providing power supply to the positive analog supply AVDD of the IC. Another MAX5084 (U1) provides a +12V power supply to the positive analog supply of the mixed-signal ports (AVDDIO) of the IC. In addition, the MAX629 (U5) provides -12V power supply to the VSSIO from +3.3V input. For bipolar applications, use an external power supply to provide negative voltage for AVSSIO. See [Figure 2](#).

Software Graphical User Interface (GUI)

The Munich software GUI is provided to facilitate evaluation of the Pmod.

Visit www.maximintegrated.com/evkitsoftware to download the latest version of the Munich GUI software. Refer to the MAX11312PMB# peripheral module and Munich (USB2PMB2) adapter board *Quick Start Guide* for step-by-step evaluation using the Munich GUI.

External Power Supply

The on-board power supply provides 70mA max current at VDDIO = +12V. If additional current is needed, use an external power supply by removing the jumper connecting VDDIO to +12V and connecting a +12V external power supply to the VDDIO pin.

For bipolar applications, remove the jumper from VSSIO pin to GND and connect it from pin 2 to pin 3. See [Figure 2](#) and refer to the MAX11312 IC data sheet for details.

External Temperature Sensors

Two-pin connector vertical headers, EXT_TEMP1 and EXT_TEMP2, are provided to measure the environment temperature. Connect the base and collector of diode-connected transistors, such as the 2N3906 to the TEMP1 or TEMP2 pin and the emitter to the EXT pin to measure the external temperature. See [Figures 3](#) and [4](#).

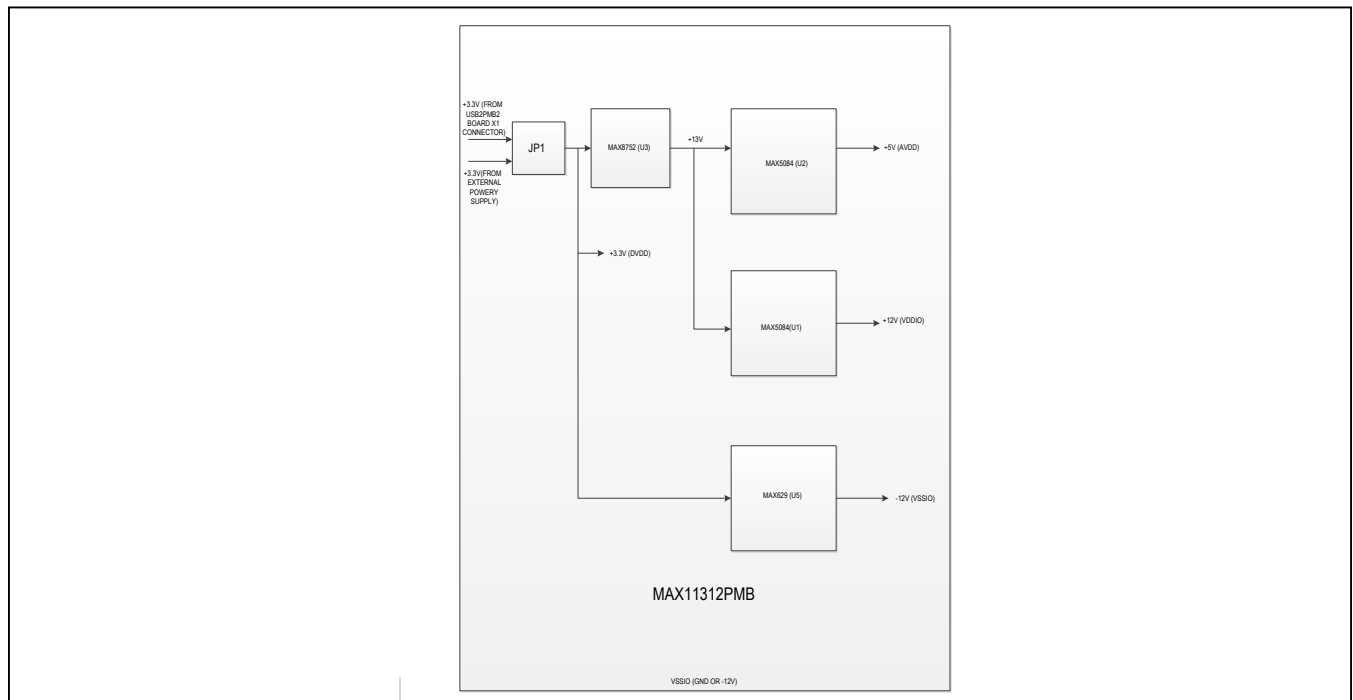

Figure 2. Power-Supply Block Diagram

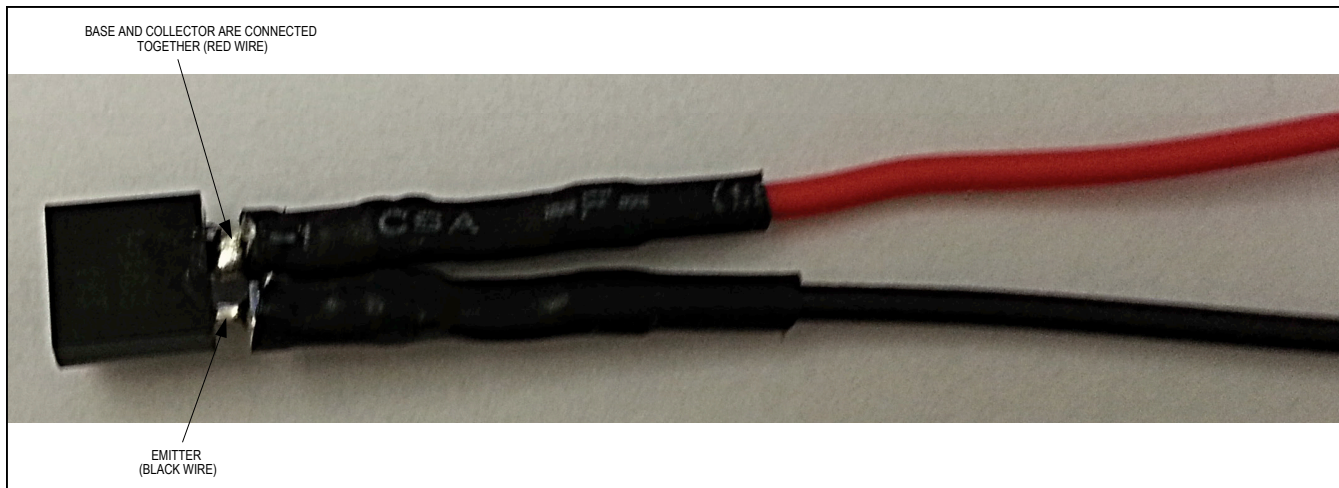

Figure 3. 2N3906 Diode-Connected Transistor Assembly (Not Included)

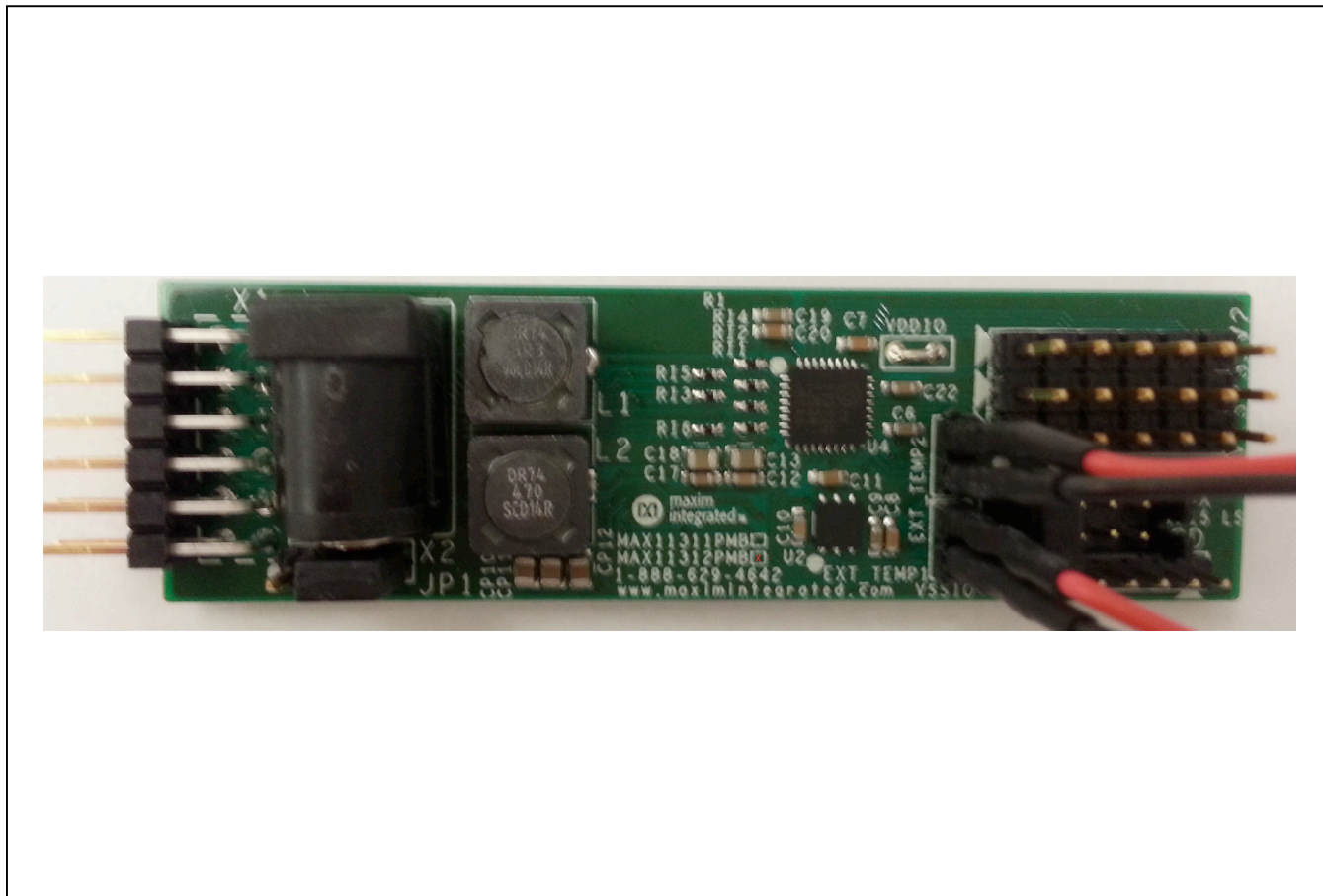

Figure 4. External Temperature Sensor Using Diode-Connected Transistor (Not Included)

Component Suppliers

SUPPLIER	WEBSITE
Pulse Electronics	www.pulseelectronics.com
TDK Corp.	www.component.tdk.com
TE Connectivity	www.te.com

Note: Indicate that you are using the MAX11312PMB# when contacting these component suppliers.

Component List, PCB Files, and Schematics

See the following links for component information, PCB layout diagrams, and schematic.

- [MAX11312PMB# EV BOM](#)
- [MAX11312PMB# EV PCB Layout](#)
- [MAX11312PMB# EV Schematic](#)

Ordering Information

PART	TYPE
MAX11312PMB#	Peripheral Module
USB2PMB2#	Munich Adapter Board
MAX11312SYS1#	Peripheral Module and Munich Adapter Board

#Denotes RoHS compliant.

Revision History

REVISION NUMBER	REVISION DATE	DESCRIPTION	PAGES CHANGED
0	2/16	Initial release	—

For pricing, delivery, and ordering information, please contact Maxim Direct at 1-888-629-4642, or visit Maxim Integrated's website at www.maximintegrated.com.

Maxim Integrated cannot assume responsibility for use of any circuitry other than circuitry entirely embodied in a Maxim Integrated product. No circuit patent licenses are implied. Maxim Integrated reserves the right to change the circuitry and specifications without notice at any time.

TITLE: Bill of Materials

DATE: 10/05/2015

DESIGN: max11312pmb_b

ITEM	REF_DES	DNI/DNP	QTY	MFG PART #	MANUFACTURER	VALUE	DESCRIPTION
1	C1, C2, C5, C15, C24	-	5	C1608X5R1A106K	TDK	10UF	CAPACITOR; SMT (0603); CERAMIC; 10V; TOL=10%; MODEL=; TG=-55 DEG C; TC=X5R
2	C3, C7, C8, C11, C14, C20	-	6	GRM188R71E105KA12D; CGA3E1X7R1E105K	MURATA	1UF	CAPACITOR; SMT (0603); CERAMIC; 25V; TOL=10%; MODEL=GRM SE; TC=X7R; DEGC TO +125 DEG C; TC=X7R
3	C4, C6, C9, C10, C12, C16, C17, C19, C21-C23, C25, C27, C28, CP2, CP8, CP9, CP13	-	18	C0603C104K4RAC; GCM188R71C104KA37; C1608X7R1C104K; GRM188R71C104K; C0603X7R160-104KNE	KEMET/MURATA/TDK/VENKEL LTD.	0.1UF	CAPACITOR; SMT (0603); CERAMIC; 16V; TOL=10%; TG=-55 DEG C TO +125 DEG C; TC=X7R;
4	C13, C18	-	2	GRM21BR61E475KA	MURATA	4.7UF	CAPACITOR; SMT (0805); CERAMIC; 25V; TOL=10%; MODEL=X5R; TG=-55 DEG C; TC=+/-125 DEG C; TC=+/-
5	CP1, CP5, CP10-CP12	-	5	ECJ-2FF1A106Z; CC0805ZKY5V6BB1	PANASONIC/YAGEO PHYCOMP	10UF	CAPACITOR; SMT (0805); CERAMIC; 10V; TOL=+80%-20%; MODEL=YAGEO; TC=X7R; DEGC TO +85 DEG C; T;
6	CP3	-	1	C1608X5R1E225K; TMK107ABJ225KA-T	TDK/TAIYO YUDEN	2.2UF	CAPACITOR; SMT (0603); CERAMIC; 25V; TOL=10%; MODEL=; TG=-55 DEG C; TC=X5R
7	CP4	-	1	C0603C224K3RAC; GMC10X7R224K25; GRM188R71E224KA88; C1608X7R1E224K08	KEMET; MURATA; TDK	0.22UF	CAPACITOR; SMT (0603); CERAMIC; 0.22UF; 25V; TOL=10%; TG=-55 DEG C; TC=X7R
8	CP6	-	1	C0603HQN101-200JNP	VENKEL LTD.	20PF	CAPACITOR; SMT; 0603; CERAMIC; 5%; C0G; -55degC to + 125degC; 30PPM/degC
9	CP7	-	1	C0603C0G500-122KNP	VENKEL LTD.	1200PF	CAPACITOR; SMT; 0603; CERAMIC; 50V; 10%; C0G; -55degC to + 125degC; 30PPM/degC

10	CP14	-	1	C2012X7R1H225K	TDK	2.2UF	CAPACITOR; SMT (0805); CERAMIC; 225K; 50V; TOL=10%; MODEL=; TG=-55 TO +125 DEGC; TC=X7R
11	CP15	-	1	C0603C151K1GAC	KEMET	150PF	CAPACITOR; SMT (0603); CERAMIC; 150K; 100V; TOL=10%; MODEL=COG; THERMAL STABILITY: +125 DEGC; TC=+
12	D1	-	1	CRS10I30A	TOSHIBA	CRS10I30A	DIODE; SCH; SMT (SOD-123F); PIV=40V
13	D2, D3	-	2	MBRS540T3G	ON SEMICONDUCTOR	MBRS540T3	DIODE; SCH; SURFACE MOUNT; POWER RECTIFIER; SMC; PIV=40V
14	EXT_TEMP1, EXT_TEMP2	-	2	PEC02SAAN	SULLINS	PEC02SAAN	CONNECTOR; MALE; THROUGH HOLE; BREAKAWAY; STRAIGHT; 2PINS
15	ICD	-	1	M22-2510605	HARWIN	M22-2510605	CONNECTOR; MALE; THROUGH HOLE; PITCH; SIL VERTICAL PIN HEADS; STRAIGHT; 6PINS
16	J1	-	1	DF11-6DP-2DSA(24)	HIROSE ELECTRIC CO LTD	DF11-6DP-2DSA(24)	CONNECTOR; MALE; THROUGH HOLE; SERIES; DOUBLE-ROW CONNECTOR; 6PINS
17	JP1, VSSIO	-	2	PEC03SAAN	SULLINS	PEC03SAAN	CONNECTOR; MALE; THROUGH HOLE; BREAKAWAY; STRAIGHT; 3PINS
18	L1	-	1	DR74-3R3-R	COILTRONICS	3.3UH	INDUCTOR; SMT; FERRITE CORE; 20%; 3.94A
19	L2	-	1	DR74-470-R	COILTRONICS	47UH	INDUCTOR; SMT; FERRITE CORE; 20%; 1.15A
20	R1, R4	-	2	RG1005P-101-B-T5; ERA-2AEB101X	SUSUMU CO LTD./PANASONIC	100	RESISTOR, 0402, 100 OHM, 0.1% TOL, 0.0625W, THICK FILM
21	R2, R5, R8	-	3	CRCW0402100KFK; RC0402FR-07100KL	VISHAY DALE; YAGEO PHICOMP	100K	RESISTOR; 0402; 100K; 1%; 100PF; THICK FILM
22	R3	-	1	CRCW040212K0FK	VISHAY DALE	12K	RESISTOR, 0402, 12K OHM, 1%, 0.0625W, THICK FILM
23	R6, R9, R11-R15	-	7	CRCW040210K0FK; RC0402FR-0710K	VISHAY DALE; YAGEO PHICOMP	10K	RESISTOR; 0402; 10K; 1%; 100PF; THICK FILM
24	R7	-	1	CRCW040240K2FK	VISHAY DALE	40.2K	RESISTOR; 0402; 40.2K OHM; 1%; 0.063W; THICK FILM
25	R10	-	1	CRCW08052R00FN	VISHAY DALE	2	RESISTOR, 0805, 2 OHM, 1%, 100PF; THICK FILM
26	RG	-	1	CRCW04020000ZS	VISHAY DALE	0	RESISTOR; 0402; 0 OHM; 0%; 100PF; THICK FILM

27	RI1-RI6	-	6	RC0402JR-070RL; CR0402-16W-000RJT	YAGEO PHYCOMP/VENKEL LTD.	0	RESISTOR; 0402; 0 OHM; 5%; JU THICK FILM
28	SV1-SV3	-	3	22-28-4063	MOLEX	22-28- 4063	CONNECTOR; MALE; THROUGH VERTICAL BREAKAWAY; STRAIGH
29	U1,U2	-	2	MAX5084ATT+T	MAXIM	MAX5084 ATT+T	IC; VREG; LOW-QUIESCENT-CUR REGULATOR; TDFN6
30	U3	-	1	MAX8752ETA+	MAXIM	MAX8752 ETA+	IC; CONV; TFT LCD STEP-UP DC- TDFN8-EP
31	U4	-	1	MAX11311	MAXIM	MAX1131 1	EVKIT PART-IC; MAX11311; PAC 21-0140; PACKAGE CODE: T3255 NO FINAL DATASHEET
32	U5	-	1	MAX629ESA+	MAXIM	MAX629E SA+	IC; CONV; LOW-POWER HIGH-V OR INVERTING DC-DC CONVERT 150MIL
33	U7	-	1	ATTINY25-20SU	ATMEL	ATTINY25- 20SU	IC; CTRL; ATMEL 8-BIT AVR MICH WITH 2K BYTES IN-SYSTEM PRO FLASH; WSOIC8
34	VDDIO	-	1	923345-01-C	?	923345- 01-C	CONNECTOR; MALE; THROUGH WIRE; STRAIGHT; 2PINS
35	X1	-	1	TSW-106-08-S-D-RA	SAMTEC	TSW-106- 08-S-D-RA	CONNECTOR; THROUGH HOLE; STRIP ASSEMBLY; RIGHT ANGLE
36	X2	-	1	KLDX-0202-B	KYCON	KLDX- 0202-B	CONNECTOR; FEMALE; THROUG POWER JACK; RIGHT ANGLE; 3P
37	RU1, RU2	DNP	2	RG1005P-102-D	SUSUMU CO LTD.	1K	RESISTOR; 0402; 1K OHM; 0.5% 0.0625W; THIN FILM
38	U6	DNP	1	PIC10F200-I/OTG	MICROCHIP	PIC10F200- I/OTG	IC; CTRL; 6-PIN; 8-BIT FLASH MICROCONTROLLER; SOT23-6



This document contains information considered proprietary, and shall not be reproduced wholly or in part, nor disclosed to others without specific written permission.

HARDWARE NAME: MAX11312PMB_EVKIT_B

HARDWARE NUMBER:

ENGINEER:

DESIGNER:

DATE: 10/05/2015

ODB++/GERBER: SILK_TOP

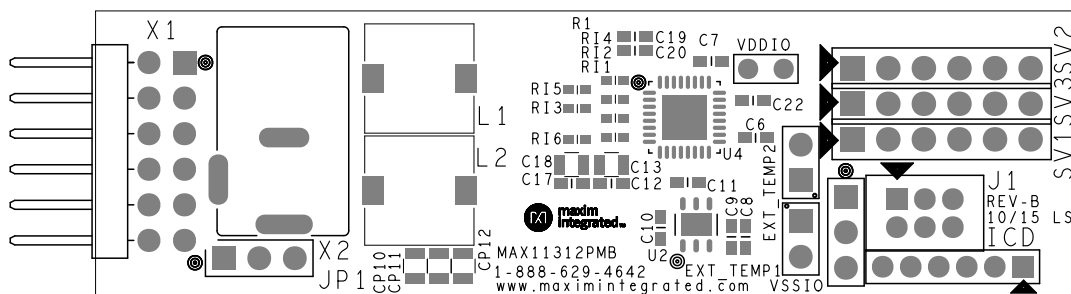



This document contains information considered proprietary,
and shall not be reproduced wholly or in part,
nor disclosed to others without specific written permission.

HARDWARE NAME: MAX11312PMB_EVKIT_B	
HARDWARE NUMBER:	
ENGINEER:	DESIGNER:
DATE: 10/05/2015	ODB++/GERBER: TOP

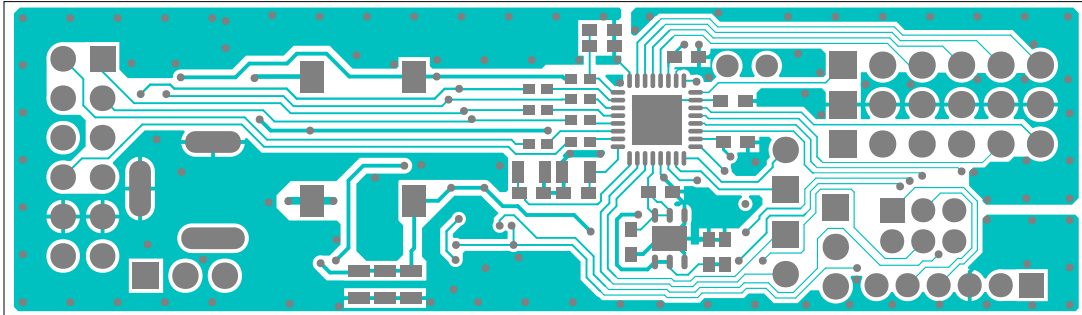



This document contains information considered proprietary, and shall not be reproduced wholly or in part, nor disclosed to others without specific written permission.

HARDWARE NAME: MAX11312PMB_EVKIT_B

HARDWARE NUMBER:

ENGINEER: DESIGNER:

DATE: 10/05/2015

ODB++/GERBER: VSS_IO

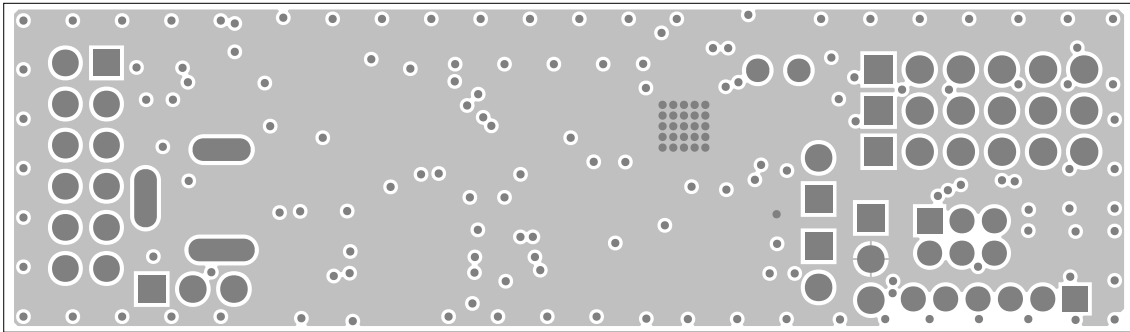



This document contains information considered proprietary, and shall not be reproduced wholly or in part, nor disclosed to others without specific written permission.

HARDWARE NAME :MAX11312PMB_EVKIT_B	
HARDWARE NUMBER :	
ENGINEER :	DESIGNER :
DATE : 10/05/2015	ODB++/GERBER : GND

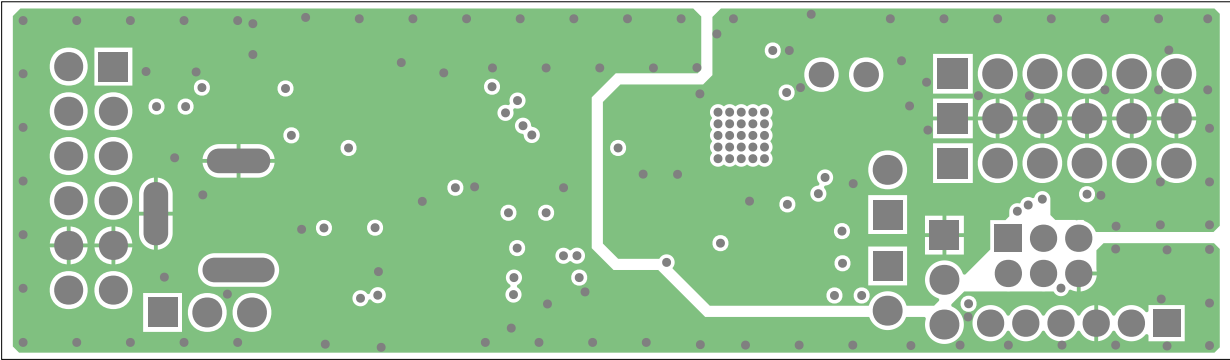



This document contains information considered proprietary, and shall not be reproduced wholly or in part, nor disclosed to others without specific written permission.

HARDWARE NAME: MAX11312PMB_EVKIT_B

HARDWARE NUMBER:

ENGINEER: DESIGNER:

DATE: 10/05/2015

ODB++/GERBER: BOTTOM

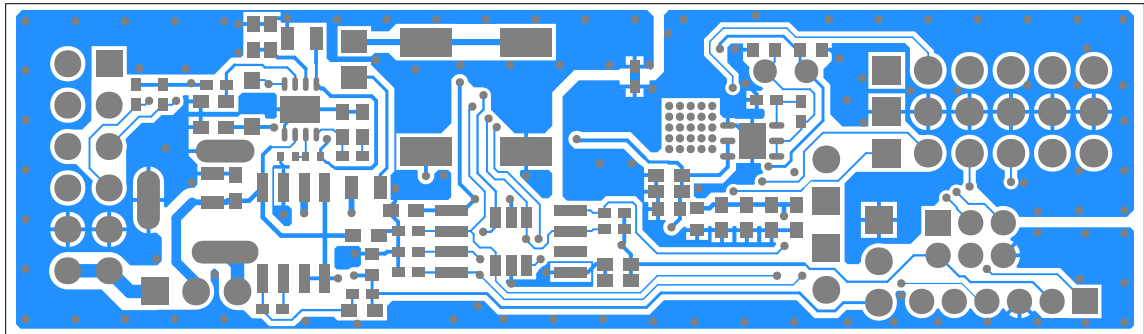

X-ON Electronics

Largest Supplier of Electrical and Electronic Components

Click to view similar products for [Data Conversion IC Development Tools](#) category:

Click to view products by [Maxim](#) manufacturer:

Other Similar products are found below :

[EVAL-AD7265EDZ](#) [EVAL-AD7719EBZ](#) [EVAL-AD7767-1EDZ](#) [EVAL-AD7995EBZ](#) [AD9211-200EBZ](#) [AD9251-20EBZ](#) [AD9251-65EBZ](#)
[AD9613-170EBZ](#) [AD9629-20EBZ](#) [AD9716-DPG2-EBZ](#) [AD9737A-EBZ](#) [AD9993-EBZ](#) [DAC8555EVM](#) [EVAL-AD5061EBZ](#) [EVAL-](#)
[AD5062EBZ](#) [EVAL-AD5443-DBRDZ](#) [EVAL-AD5570SDZ](#) [EVAL-AD7992EBZ](#) [EVAL-AD7994EBZ](#) [AD9119-MIX-EBZ](#) [AD9233-125EBZ](#)
[AD9629-80EBZ](#) [AD9650-80EBZ](#) [AD9767-EBZ](#) [DAC8531EVM](#) [LM96080EB/NOPB](#) [EVAL-AD5445SDZ](#) [EVAL-AD5660EBZ](#) [EVAL-](#)
[AD7685SDZ](#) [EVAL-AD7687SDZ](#) [MAX5318PMB#](#) [MAX1246EVL11-QSOP](#) [MAX117EVKIT-DIP](#) [DC2365A-C](#) [DC2795A-B](#) [DC2795A-A](#)
[DAC088S085EB/NOPB](#) [SIM8909-EVB-KIT](#) [82635ASRCDVKHV 961443](#) [DC1466B-B](#) [EVAL-AD5413SDZ](#) [ADC12D1600RB/NOPB](#) [1083](#)
[RFPDK FOR CMT2X5X](#) [TS7003DB](#) [TSC2014EVM-PDK](#) [MOD-USB3G](#) [KDC5514EVALZ](#) [650201392G](#) [ISL28005FH-100EVAL1Z](#)