

General Description

The MAX14691 evaluation kit (EV kit) is a fully assembled and tested circuit board that demonstrates the MAX14691 overvoltage, undervoltage, and overcurrent-protection device. The EV kit features an external pMOSFET and LED input and output reading. The EV kit comes with the MAX14691ATP+ installed, but can also be used to evaluate the pin-compatible MAX14692 and MAX14693 devices with IC replacement of U1. Request samples from Maxim when ordering the EV kit.

Features

- 5.5V to 58V Operating Voltage Range
- External pMOSFET Installed
- Proven PCB Layout
- Fully Assembled and Tested

[Ordering Information](#) appears at end of data sheet.

Quick Start

Required Equipment

- MAX14691 EV kit
- 40V DC power supply
- 5V DC power supply
- Multimeter

Procedure

The EV kit is fully assembled and tested. Follow the steps below to verify board operation:

- 1) Verify that all jumpers are in their default positions.
- 2) Set the 40V DC power supply to 10V and connect to V_{IN} (TP1).
- 3) Connect the 5V DC power supply to VIO (TP21).
- 4) Turn on both power supplies. Verify that LED1 is on, and \overline{FLAG} (TP15) is 0V.
- 5) Increase voltage on the DC power supply to TP1 and verify that LED2 turns on when voltage reaches ~12.4V. Also check that voltage on V_{OUT} (TP5) is ~12.4V and \overline{FLAG} (TP15) is 5V.
- 6) Increase voltage on the DC power supply to TP1 and verify that LED2 turns off when voltage reaches ~36.2V. Also check that voltage on V_{OUT} (TP5) goes down and \overline{FLAG} (TP15) is 0V.
- 7) Decrease voltage on the DC power supply to TP1 and verify that LED2 turns on when voltage reaches ~34.1V. Also check that voltage on V_{OUT} (TP5) is ~34.1V and \overline{FLAG} (TP15) is 5V.
- 8) Decrease voltage on the DC power supply to TP1 and verify that LED2 turns on when voltage reaches ~12V. Also check that voltage on V_{OUT} (TP5) goes down and \overline{FLAG} (TP15) is 0V.

Detailed Description of Hardware

The MAX14691 EV kit is a fully assembled and tested circuit board demonstrating the MAX14691 overvoltage, undervoltage, and overcurrent-protection device in a 20-pin surface-mount TQFN-EP package.

The EV kit also features LEDs to indicate the power for input and output (see [Table 1](#)).

Table 1. LED Indicator (LED1, LED2)

LED	DESCRIPTION
LED1	LED1 is on when IN is powered
LED2	LED2 is on when OUT is powered

Table 2. Enable Inputs Jumper Settings (JU1, JU12)

JUMPER	SHUNT POSITION	DESCRIPTION
JU1	1-2	$\overline{\text{HVEN}}$ is connected to VIN
	2-3*	$\overline{\text{HVEN}}$ is connected to GND
JU12	Installed	EN is high
	Not installed*	EN is low

*Default position.

Table 3. Enable Inputs Switch Status

EN	$\overline{\text{HVEN}}$	SWITCH STATUS
0	0	On
1	0	On
0	1	Off
1	1	On

Table 5. UVLO Threshold Jumper Settings (JU4, JU6)

JUMPER	SHUNT POSITION	DESCRIPTION
JU4	Installed*	UVLO is connected to ground; internal UVLO threshold is used (do not install JU6)
	Not installed	UVLO is open
JU6	Installed	UVLO is connected to external voltage-divider; use R4/R5 or R7 to set undervoltage threshold (do not install JU4)
	Not installed*	UVLO is open

*Default position.

Enable Inputs (EN, $\overline{\text{HVEN}}$)

Use jumpers JU1 and JU12 to enable the device (see [Table 2](#) for jumper settings and [Table 3](#) for enable switch status).

Overvoltage-Lockout Threshold (OVLO)

Use jumpers JU3 and JU5 to select internal or external OVLO threshold. Install a shunt on either JU3 or JU5, but not both at the same time (see [Table 4](#) for jumper settings).

Undervoltage-Lockout Threshold (UVLO)

Use jumpers JU4 and JU6 to select internal or external UVLO threshold. Install a shunt on either JU4 or JU6, but not both at the same time (see [Table 5](#) for jumper settings).

Table 4. OVLO Threshold Jumper Settings (JU3, JU5)

JUMPER	SHUNT POSITION	DESCRIPTION
JU3	Installed*	OVLO is connected to ground; internal OVLO threshold is used (do not install JU5)
	Not installed	OVLO is open
JU5	Installed	OVLO is connected to external voltage-divider; use R2/R3 or R6 to set overvoltage threshold (do not install JU3)
	Not installed*	OVLO is open

*Default position.

Current-Limit Threshold

Use jumpers JU7–JU10 to use different resistors to program the current-limit threshold (see [Table 6](#) for jumper settings).

Reverse-Current Blocking

Use JU13 to enable/disable reverse current-blocking (see [Table 7](#) for jumper settings). RIPEN is usually pulled up high from VIO. When there is only power on OUT and no power on VIO, RIPEN needs to be high to avoid damaging the input. Set JU13 to 1-2 in this case.

Table 6. Current-Limit Threshold Jumper Settings (JU7–JU10)

JUMPER	SHUNT POSITION	DESCRIPTION
JU7	Installed*	SET1 is connected to ground with a 62kΩ resistor (~0.6A current limit)
	Not installed	SET1 is not connected to ground with a 62kΩ resistor
JU8	Installed	SET1 is connected to ground with a 13kΩ resistor (~2.9A current limit)
	Not installed*	SET1 is not connected to ground with a 13kΩ resistor
JU9	Installed	SET1 is connected to ground with a 6.8kΩ resistor (~5.5A current limit)
	Not installed*	SET1 is not connected to ground with a 6.8kΩ resistor
JU10	Installed	SET1 is connected to ground with a 100kΩ potentiometer (programmable current limit)
	Not installed*	SET1 is not connected to ground with a 100kΩ potentiometer

*Default position.

Current-Limit Mode

Use jumpers JU14 and JU15 to select the current-limit mode (see [Table 8](#) for jumper settings).

Table 7. Reverse-Current Blocking Jumper Settings (JU13)

JUMPER	SHUNT POSITION	DESCRIPTION
JU13	Open	RIPEN is low (disable)
	1-2	RIPEN is high (enable) from either IN or OUT
	2-3*	RIPEN is high (enable) from VIO

*Default position.

Table 8. Current-Limit Type Jumper Settings (JU14, JU15)

JUMPER	SHUNT POSITION	DESCRIPTION
JU14	Installed*	CLTS2 is low
	Not installed	CLTS2 is high
JU15	Installed	CLTS1 is low
	Not installed*	CLTS1 is high

*Default position.

Table 9. Current-Limit Type Select (CLTS1, CLTS2)

CLTS2	CLTS1	CURRENT-LIMIT TYPE
0	0	Latchoff mode
0	1	Autoretry mode
1	0	Continuous mode
1	1	Continuous mode

Component Suppliers

SUPPLIER	WEBSITE
Bourns, Inc.	www.bourns.com
Lite-On, Inc.	www.us.liteon.com
Lumex North America	www.lumex.com
ON Semiconductor	www.onsemi.com
Vishay Americas	www.vishay.com

Note: Indicate that you are using the MAX14691 when contacting these component suppliers.

Component Information, PCB Layout, and Schematic

See the following links for component information, PCB layout diagrams, and schematic.

- [MAX14691 EV BOM](#)
- [MAX14691 EV PCB Layout](#)
- [MAX14691 EV Schematic](#)

Ordering Information

PART	TYPE
MAX14691EVKIT#	EV Kit

#Denotes RoHS compliant.

Revision History

REVISION NUMBER	REVISION DATE	DESCRIPTION	PAGES CHANGED
0	12/14	Initial release	—
1	3/16	Updated RIPEN circuit to reflect change from VIO to pullup	1–8

For pricing, delivery, and ordering information, please contact Maxim Direct at 1-888-629-4642, or visit Maxim Integrated's website at www.maximintegrated.com.

Maxim Integrated cannot assume responsibility for use of any circuitry other than circuitry entirely embodied in a Maxim Integrated product. No circuit patent licenses are implied. Maxim Integrated reserves the right to change the circuitry and specifications without notice at any time.

Bill of Materials - Revision 3/16

Part Reference	Qty	Description
C1	1	CAPACITOR CER 0.1UF 100V ±10% X7R 1206
C2, C4	2	CAPACITOR RADIAL 10UF 63V ±20%
C3	1	CAPACITOR CER 1UF 6.3V ±10% X5R 0603
C5	1	CAPACITOR CER 1UF 100V ±10% X7R 1206
D1	1	DIODE 1A 50V
D2	1	DIODE TVS 1500 WATT TRANSIENT VOLTAGE SUPPRESSOR 1A 36V
D3	1	DIODE ZENER 3.3V 0.02A SOT23-3
D4	1	DUAL DIODE 80V 0.25A SOT-963
JU1, JU13	2	CONN HEADER 3PINS
JU3-JU10, JU12, JU14, JU15	11	CONN HEADER 2PINS
LED1	1	LED GREEN 1206
LED2	1	LED YELLOW 1206
Q1	1	P-CHANNEL 60V 50A MOSFET
R1	1	RES 220K OHM 1% 0805 SMD
R6, R7	2	RES TRIMMER POTENTIOMETER 1M OHM
R8	1	RES 62K OHM 1% 0805 SMD
R9	1	RES 13K OHM 1% 0805 SMD
R10	1	RES 6.8K OHM 1% 0805 SMD
R11	1	RES TRIMMER POTENTIOMETER 100K OHM
R12, R13, R15, R16	4	RES 10K OHM 1% 0805 SMD
R14, R21	2	RES 100K OHM 1% 0805 SMD
R17, R18	2	RES 2.7K OHM 1% 0805 SMD
R19, R20	2	RES 0 OHM 0805 SMD
R22, R23	2	RES 10K OHM 0805 5% SMD
TP1, TP2, TP5, TP6, TP17, TP18	6	RED TEST POINT
TP3, TP4, TP7, TP8, TP22-TP27	10	BLACK TEST POINT
TP9, TP10, TP14, TP16, TP20	5	YELLOW TEST POINT
TP11-TP13, TP15, TP19	5	WHITE TEST POINT
TP21	1	ORANGE TEST POINT
U1	1	IC OVERCURRENT OVERVOLTAGE UNDERVOLTAGE PROTECTOR (MAX14691ATP+)
	1	PCB :EPCB14691
DNI		
R2-R5	0	RESISTOR; 0805 PACKAGE; GENERIC

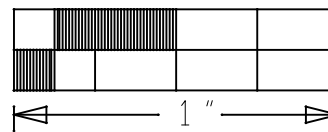
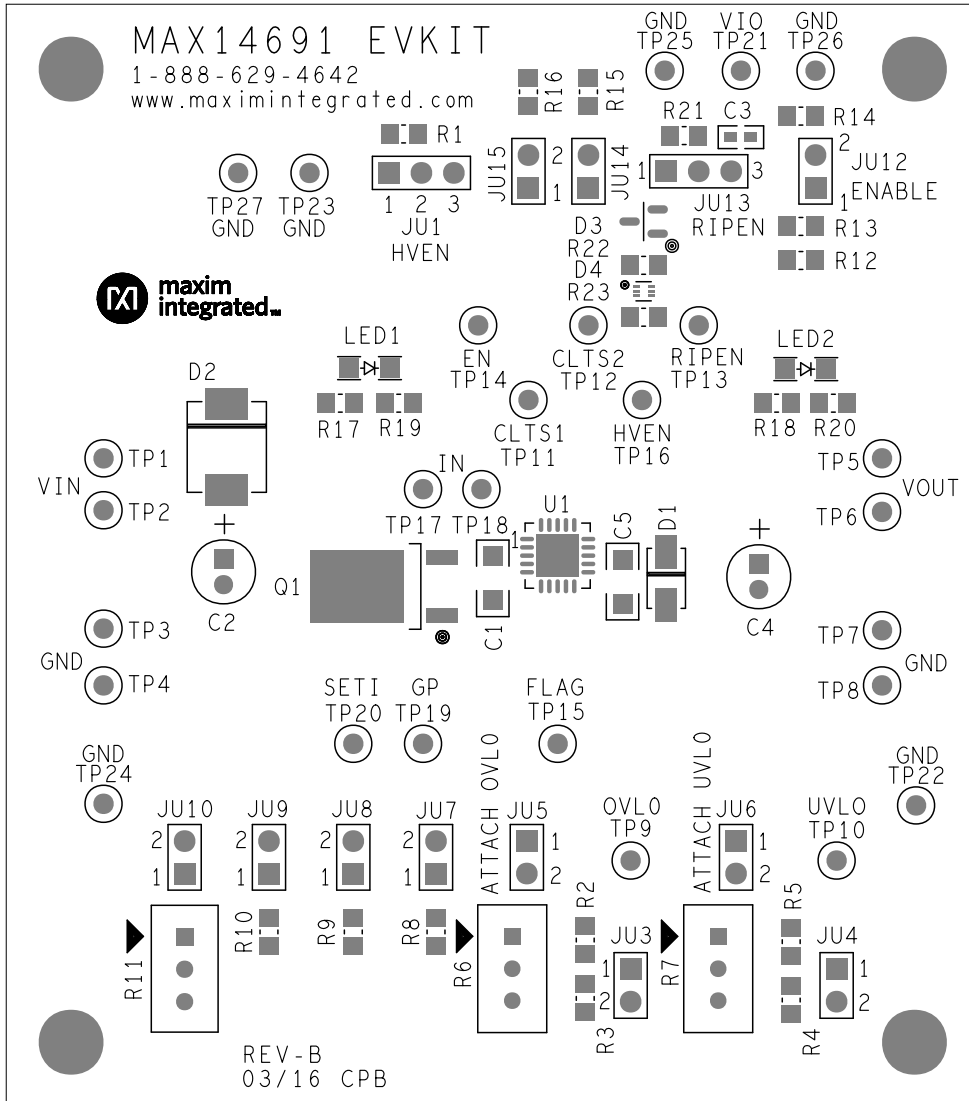

Component Placement Guide—Component Side

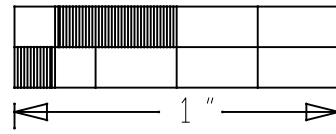
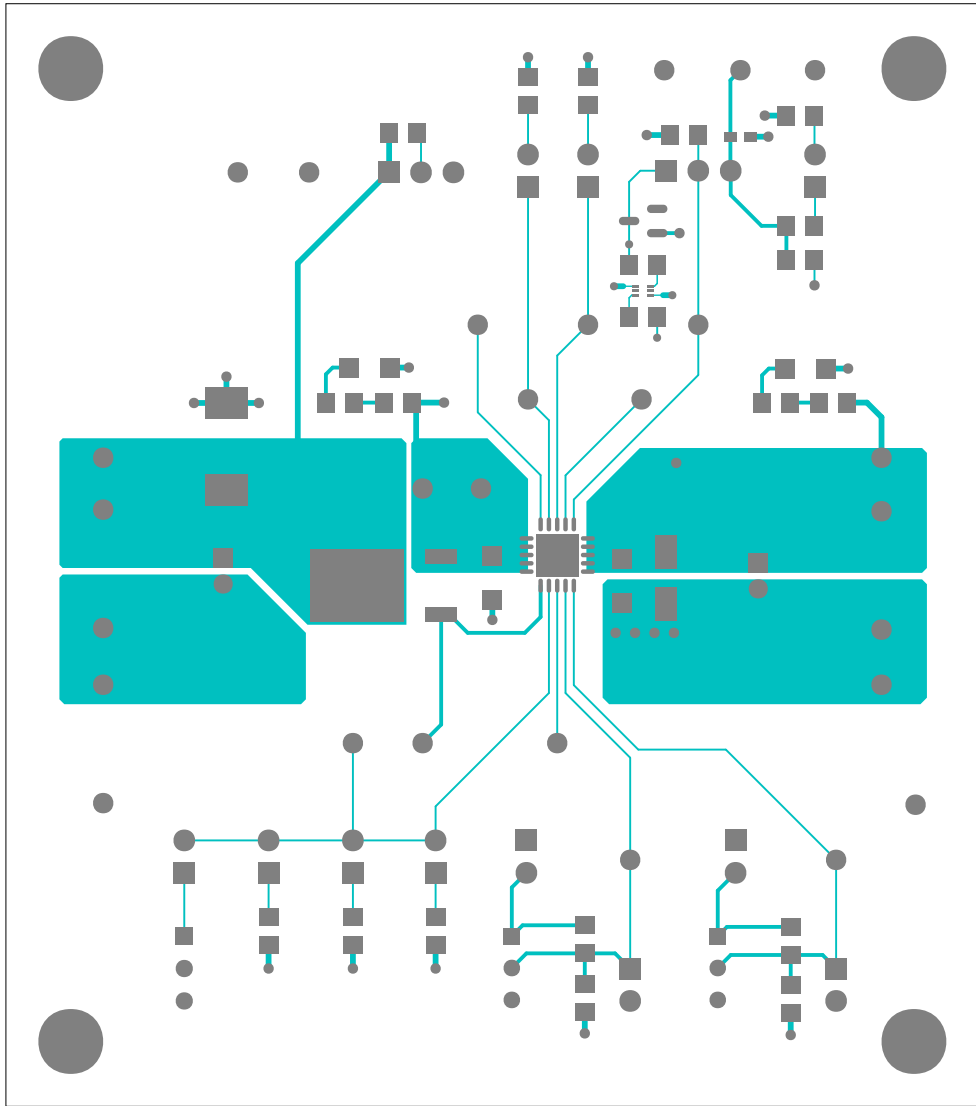

PCB Layout—Component Side

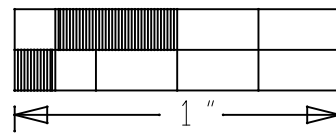
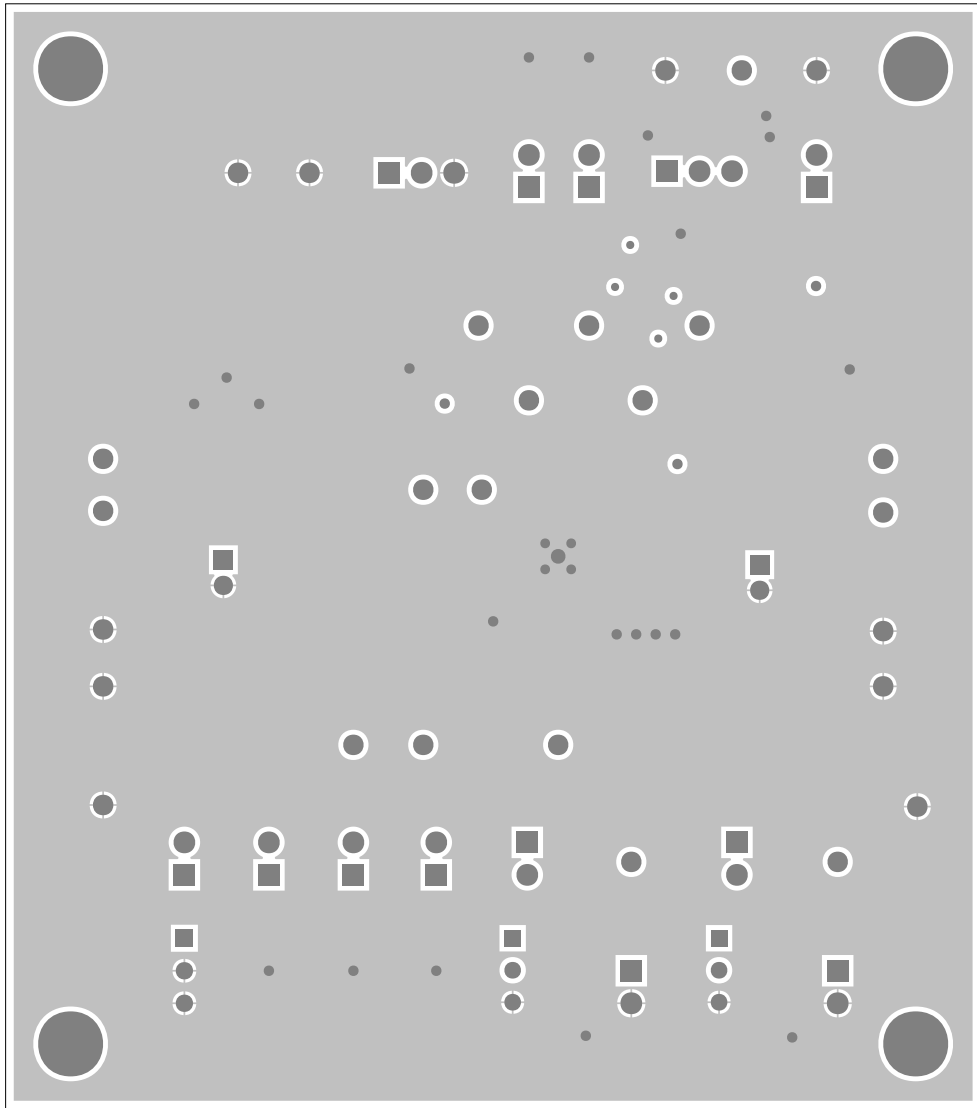

PCB Layout—Internal 2

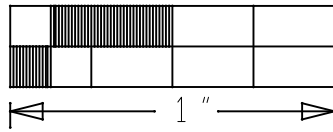
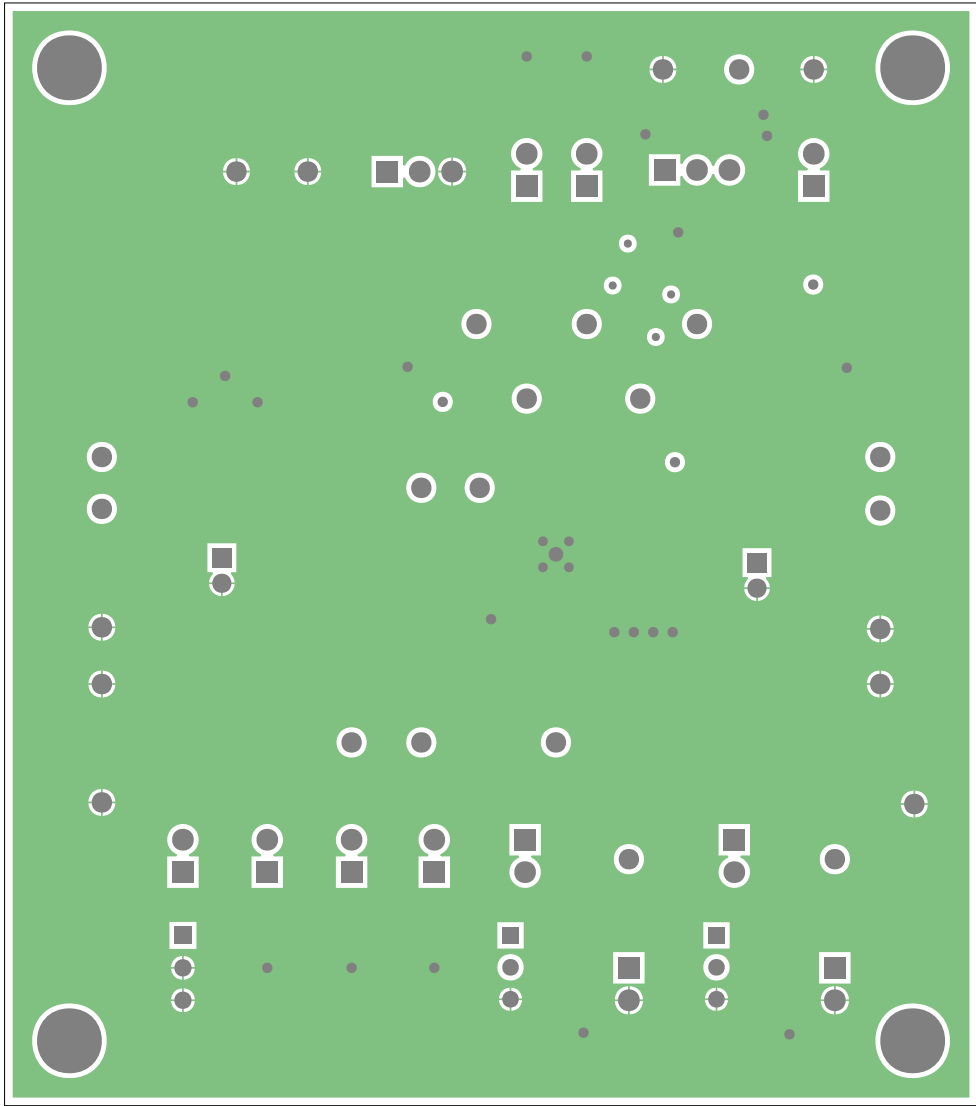

PCB Layout—Internal 3

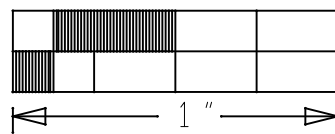
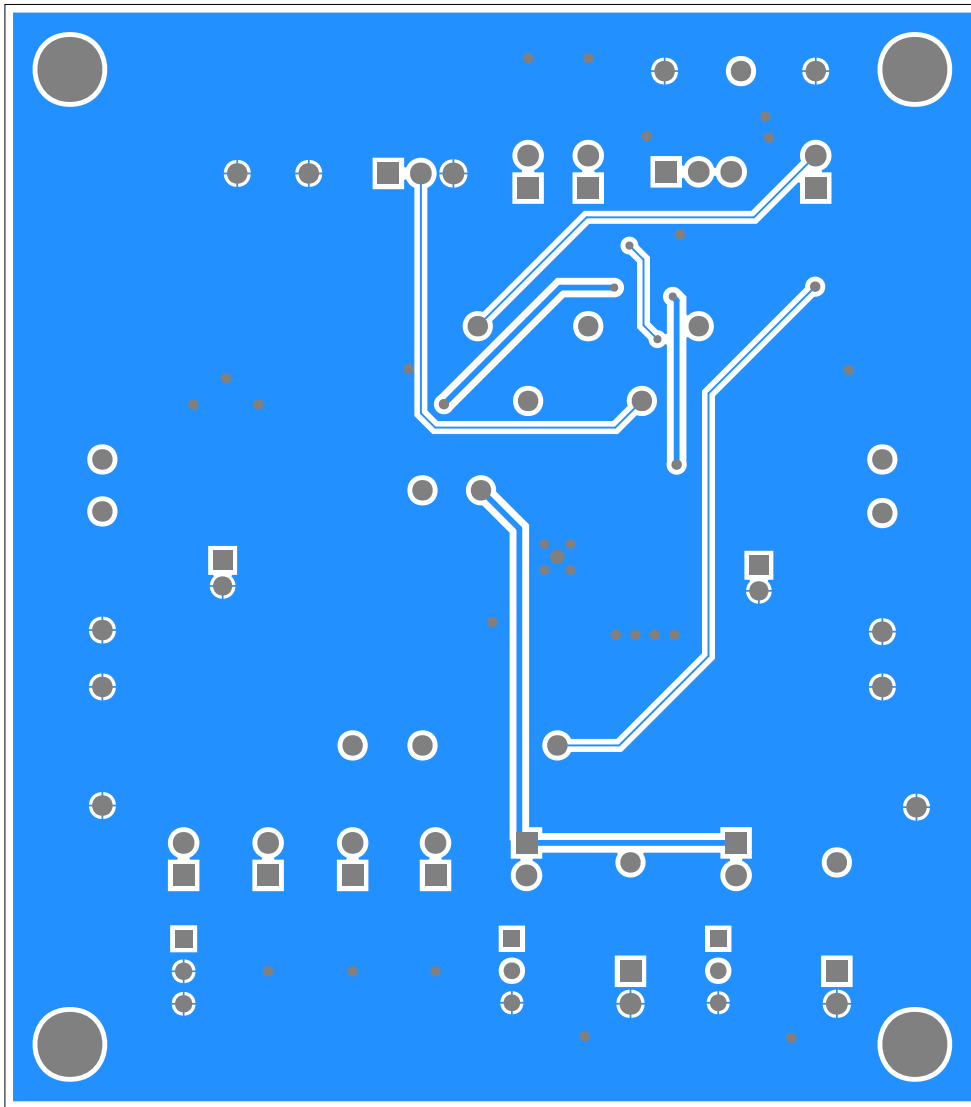

PCB Layout—Solder Side

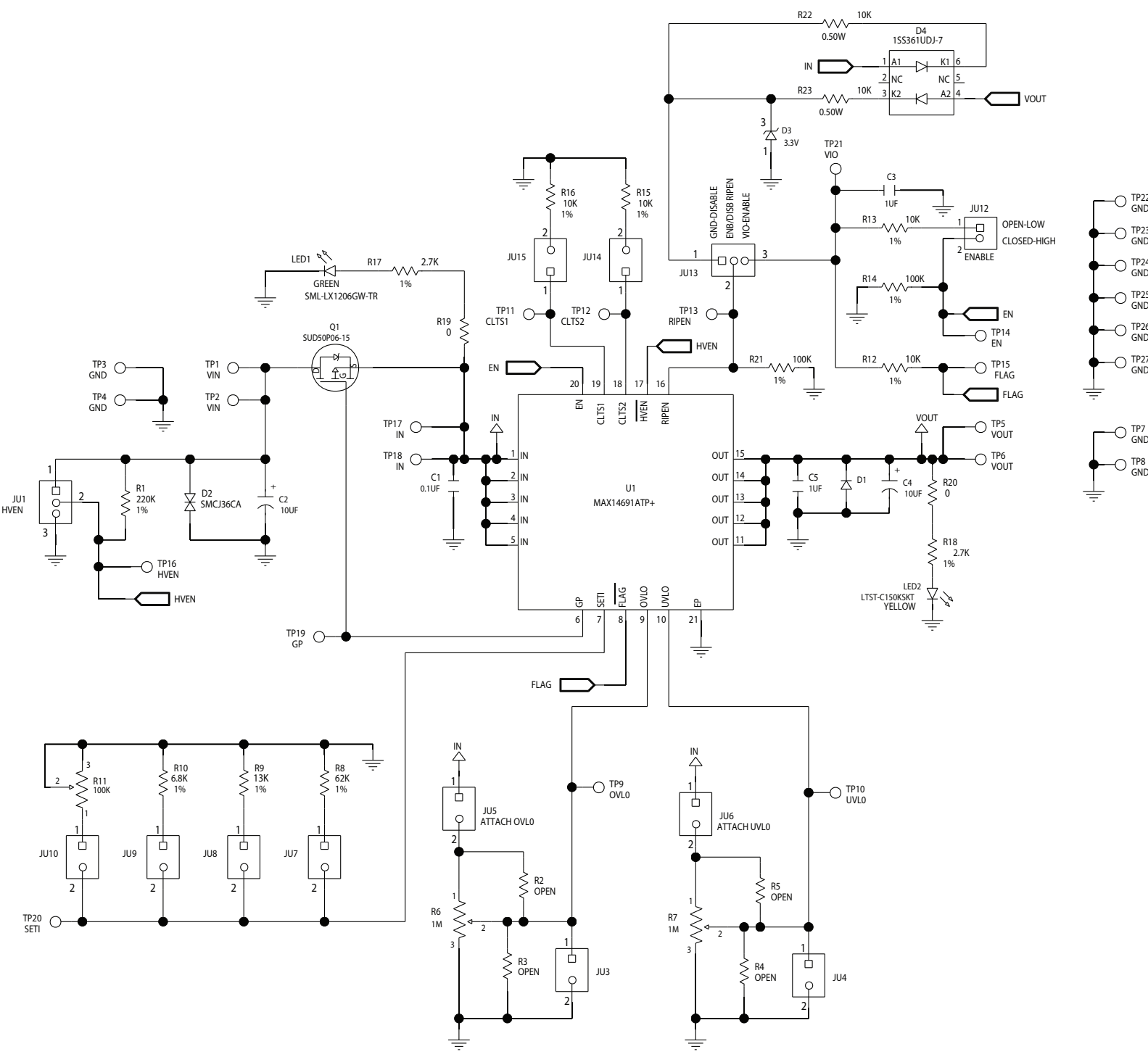

- TP22 GND
- TP23 GND
- TP24 GND
- TP25 GND
- TP26 GND
- TP27 GND

- TP7 GND
- TP8 GND

X-ON Electronics

Largest Supplier of Electrical and Electronic Components

Click to view similar products for [Power Management IC Development Tools](#) category:

Click to view products by [Maxim](#) manufacturer:

Other Similar products are found below :

[EVB-EP5348UI](#) [MIC23451-AAAYFL EV](#) [MIC5281YMME EV](#) [124352-HMC860LP3E](#) [DA9063-EVAL](#) [ADP122-3.3-EVALZ](#) [ADP130-0.8-EVALZ](#) [ADP130-1.8-EVALZ](#) [ADP1740-1.5-EVALZ](#) [ADP1870-0.3-EVALZ](#) [ADP1874-0.3-EVALZ](#) [ADP199CB-EVALZ](#) [ADP2102-1.25-EVALZ](#) [ADP2102-1.875EVALZ](#) [ADP2102-1.8-EVALZ](#) [ADP2102-2-EVALZ](#) [ADP2102-3-EVALZ](#) [ADP2102-4-EVALZ](#) [AS3606-DB](#) [BQ25010EVM](#) [BQ3055EVM](#) [ISLUSBI2CKIT1Z](#) [LP38512TS-1.8EV](#) [EVAL-ADM1186-1MBZ](#) [EVAL-ADM1186-2MBZ](#) [ADP122UJZ-REDYKIT](#) [ADP166Z-REDYKIT](#) [ADP170-1.8-EVALZ](#) [ADP171-EVALZ](#) [ADP1853-EVALZ](#) [ADP1873-0.3-EVALZ](#) [ADP198CP-EVALZ](#) [ADP2102-1.0-EVALZ](#) [ADP2102-1-EVALZ](#) [ADP2107-1.8-EVALZ](#) [ADP5020CP-EVALZ](#) [CC-ACC-DBMX-51](#) [ATPL230A-EK](#) [MIC23250-S4YMT EV](#) [MIC26603YJL EV](#) [MIC33050-SYHL EV](#) [TPS60100EVM-131](#) [TPS65010EVM-230](#) [TPS71933-28EVM-213](#) [TPS72728YFFEVM-407](#) [TPS79318YEQEVM](#) [UCC28810EVM-002](#) [XILINXPWR-083](#) [LMR22007YMINI-EVM](#) [LP38501ATJ-EV](#)