

MAX14915 Evaluation Kit

Evaluates: MAX14915

General Description

The MAX14915 evaluation kit (EV kit) provides a proven design to evaluate the MAX14915, octal high-side switch with extended diagnostics. The EV kit includes the MAX14915 evaluation board and a graphical user interface (GUI) that provides communication from a PC to the target device through a USB port and the USB2GPIO interface board. The USB2GPIO EV kit should be ordered separately.

The GUI is compatible with Windows 10 for exercising the features of the MAX14915 IC. The EV kit GUI allows individually controlling of eight high-side switches through the high-speed SPI interface and receive a diagnostic information from the MAX14915, including open-wire/open-load conditions, state of the output channels, multiple undervoltage alarms, global and per channel overtemperature alarms, and multiple fault alarms.

The MAX14915 EV kit must be powered from an external +24V power supply and can consume more than 10A when fully loaded. The USB2GPIO interface board is powered from the USB port.

The MAX14915 EV kit board comes with a MAX14915AFM+ installed in a 48-pin, 6 x 6mm FC2QFN package.

Features

- Robust Operation with Wide Range Of Input Voltages and Load Conditions
- VDDOK Indication
- LED Indication of Channels Status and Fault Conditions
- Fast Inductive Load Demagnetization
- Open-wire, Overload, Undervoltage, Overcurrent, Thermal Shutdown Fault Conditions Indication
- Supports Watchdog and SYNCH Features
- Communication Error Indication
- Wide Logic Voltage Range
- Pin Addressable SPI Communication
- -40°C to +125°C Temperature Range
- Proven PCB Layout
- Fully Assembled and Tested
- Windows 10 Compatible Software

[Ordering Information](#) appears at end of data sheet.

MAX14915 EV System

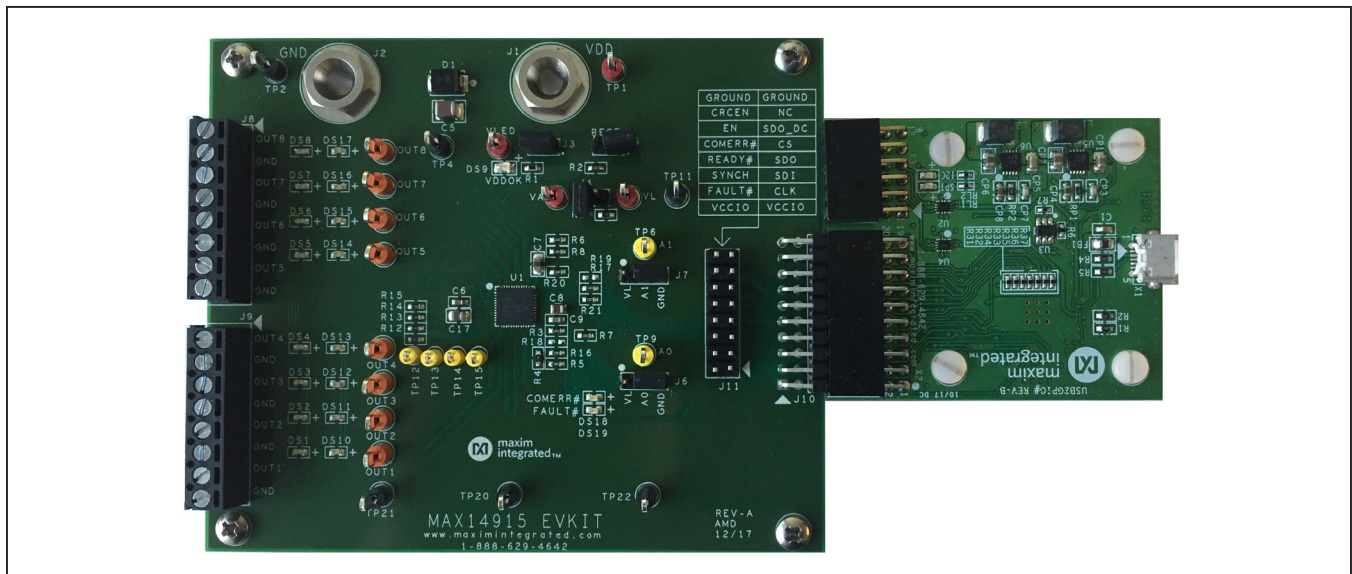

System Block Diagram

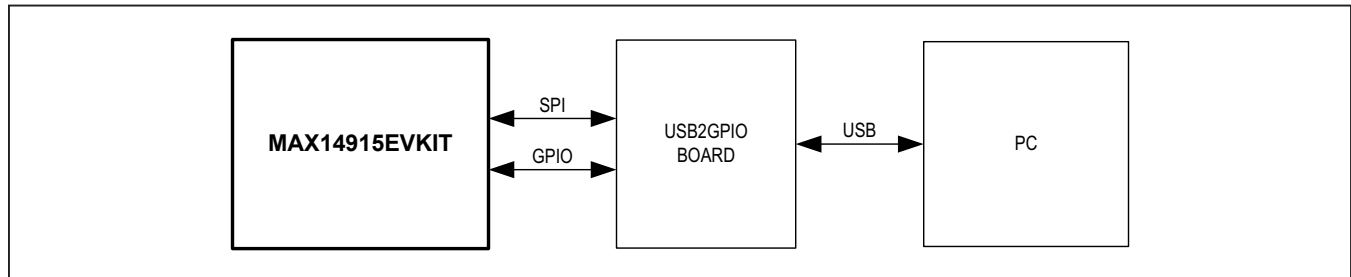

MAX14915 EV kit Files

FILE	DESCRIPTION
MAX14915EV kitSetupV1.0.exe	Application Program (GUI)

Quick Start

Required Equipment

- MAX14915 EV kit
- USB2GPIO EV kit (must be ordered separately)
- +24V DC power supply
- PC with installed Windows 10 and a USB port
- USB-A to micro-USB cable (not included)

Note: In the following section(s), software-related items are identified by bolding. Text in **bold** refers to items directly from the EV system software. Text in **bold and underline** refers to items from the Windows operating system.

Procedure

The EV kit is fully assembled and tested. Follow the steps below to verify board operation:

- 1) Visit [HERE](#) and click on *Design Resources* to download the latest version of the EV kit software, MAX14915EV kit.ZIP. Save the EV kit software to a temporary folder and uncompress the ZIP file.
- 2) Install the EV kit software on your computer by running the MAX14915EV kitSetupV1.0.exe program inside the temporary folder. The program files are copied to your PC and icons are created in the Windows **Start | Programs** menu.
- 3) Verify that all jumpers are in their default positions ([Table 1](#)).
- 4) Power up the EV kit with +24V from an external power supply through J1 and J2 Banana Plugs.
- 5) Connect the EV SYS to a USB port of a PC. A micro-USB cable is not included and should be obtained locally.
- 6) Start the EV kit software by opening its icon in the **Start | Programs** menu. The EV kit software appears as shown in [Figure 1](#). Verify that the lower-right status bar indicates the EV kit hardware is **Connected**.
The GUI automatically detects EV kit is connected to the PC and enables serial communication. Any configuration change can be made on Register Settings tab.
(The following steps are used to verify functionality of the MAX14915)
- 7) Select Register Settings tab and press the Read All button twice to clear the initially detected undervoltage global conditions in the GlobalErr register 0x09.
- 8) Enable the desirable diagnostics in registers 0x0A through 0x0F. For example, allowing STATUS LEDs and FAULT LEDs to be controlled autonomously by the internal logic, by disabling SLEDSet and FLEDSet bits in the Config1 register 0x0D[1:0] = 00b. Select register 0x0D in the Register map table on the left and choose "0: Disabled" from the pull-down menu of the bit Setting column of the register description table on the right. The font color of the modified register is changed from black to red. Click Write Modified button to write a new configuration into the register.
- 9) Set all OUTPUT switches ON, by typing in 255 decimal number into SetOUT register 0x00. Note, the GUI accept decimal, hex or binary numbers (e.g., 255, or 0xFF, or 0b11111111). The user can enable Auto Write button to allow auto write the changes instead of clicking Write Modified or Write Selected buttons, that allow individual command to be sent to the MAX14915.

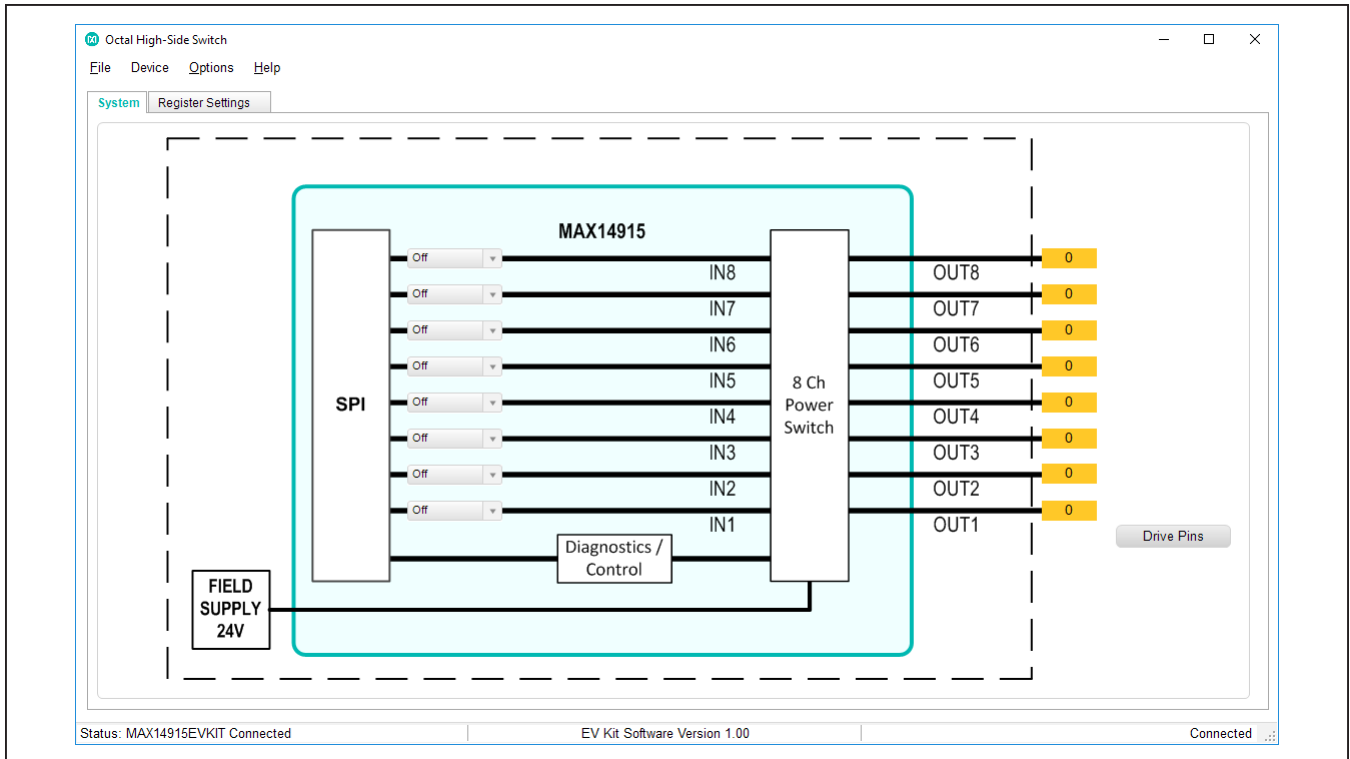

Figure 1. MAX14915 EV Kit GUI System Tab

Addr	R/W	Register	Value	Description
0x00	R/W	SetOUT	0b10001110	Sets the Output Switch on / off
0x01	R/W	SetFLED	0b00000000	Sets Fault LEDs
0x02	R/W	SetSLED	0b00000000	Sets Status LEDs
0x03	R	Interrupt	0b00000000	Provides IRQ Info
0x04	R	OvChF	0b00000000	Over Voltage fault per Channel
0x05	R	CurrLimF	0b00000000	Current Limit fault per Channel
0x06	R	OwOffChF	0b00000000	Open Wire Fault Off-State per Channel
0x07	R	OwOnChF	0b00000000	Open Wire Fault On-State per Channel
0x08	R	ShVDDChF	0b00000000	Short to VDD Fault per Channel
0x09	R	GlobalErr	0b00000000	Global Errors
0x0A	R/W	OwOffEn	0b00000000	Enable Open Wire detection Off-State
0x0B	R/W	OwOnEn	0b00000000	Enable Open Wire detection On-State
0x0C	R/W	ShVddEn	0b00000000	Enable Short to VDD Fault
0x0D	R/W	Config1	0b01010011	Global Configuration 1
0x0E	R/W	Config2	0b00000000	Global Configuration 2
0x0F	R/W	Mask	0b10111110	Enable Global Error detection

Bit	Name	Value	Setting	Description
B[7]	On8	0b1	1: On	Switch 8
B[6]	On7	0b0	0: Off	Switch 7
B[5]	On6	0b0	0: Off	Switch 6
B[4]	On5	0b0	0: Off	Switch 5
B[3]	On4	0b1	1: On	Switch 4
B[2]	On3	0b1	1: On	Switch 3
B[1]	On2	0b1	1: On	Switch 2
B[0]	On1	0b0	0: Off	Switch 1

Pin Name	Set	Setting	Read	Direction
EN	Enabled	1	1	IN
CRCEEN	Off	0	0	IN
SYNCH	On	1	1	IN
READY#	Normal Operation	0	0	OUT
FAULT#	Normal Operation	1	1	OUT
COMERR#	Normal Operation	1	1	OUT

Last SDO Diagnostic Result	Value	Description
SHRT24	0	Short to 24V present
WBOOnF	0	Wire Break Switch On
WBOOff	0	Wire Break Switch Off
CurrLim	0	Current Limiting
OvldF	0	Overload Fault
GLOBLF	0	Global Fault
Fault Bits	0b00000000	

Figure 2. MAX14915 EV Kit GUI Register Settings Tab

Detailed Description of Hardware

The MAX14915EV kit in conjunction with the USB2GPIO# adapter board provides easy to use and flexible solution for evaluation of the MAX14915, octal high-side switch for industrial applications. It allows SPI communication between the Windows compatible GUI installed on a PC, and the MAX14915. The USB2GPIO# adapter board is a plug and play device that is powered from the USB port and does not require any additional configuration, refer to the USB2GPIO data sheet [HERE](#). A USB driver for the USB2GPIO# board is installed automatically with the MAX14915 GUI.

The MAX14915EV kit# can be used as a standalone board connected to the SPI bus using J6 or/and J7 headers, refer to the MAX14915 EV kit schematic. Up to four EV kits can be connected to the same SPI bus with

selectable address for each board by appropriate J11 and J12 jumper settings. For full configuration options, refer to [Table 1](#).

Load for each channel should be connected to the J8 and J9 terminal block. Each channel (switch) can provide about 1A of current (typ) and can handle either resistive or inductive load.

On board diagnostics provide VDD status through VDDOK LED (DS9), communication error via COMERR# LED (DS18) and a global fault condition via FAULT# LED (DS19). Per channel output state and per channel fault conditions are visible via LED matrix, DS1 through DS8, and DS10 through DS17, correspondently. Other diagnostics are provided through the SPI interface by reading the diagnostic registers 0x03 through 0x09.

Table 1. MAX14915 Board Shunt Positions & Settings

HEADER	SHUNT POSITION	DESCRIPTION
J3	1-2*	VLED supplied from VDD.
	Open	Use an external VLED source. Apply VLED power between VLED test point and GND (TP4).
J4	1-2	Select 3.3V logic level (VL=VA).
	Open*	Logic voltage (VL) supplied from USB2GPIO board (3.3V). Use an external source between VL and GND (TP11) if another host controller is used.
J5	Open*	Internal 3.3V VA regulator enabled.
	1-2	Internal VA regulator disabled (REGEN=GND). Use an external VA source between VA test point and GND (TP4).
J6	1-2	Set address bit A0 = 1.
	2-3*	Set address bit A0 = 0.
J7	1-2	Set address bit A1 = 1.
	2-3*	Set address bit A1 = 0.

*Default configuration

Detailed Description of Software

The MAX14915 GUI provides access to all registers and allows full configuration and control of the MAX14915. There are two tabs available to control the EV kit. The System tab provides system-level control of the selected output pins, including static and dynamic control. The Register Settings tab provides per-channel and enhanced diagnostic configuration.

System Tab

The **System** tab allows driving the output pins by configuring each output either on, off, or driving Square wave frequency from pull-down menu, as shown in [Figure 3](#).

Click Drive Pins button on the right-side of the GUI to drive the outputs. The indicators connected to the OUT_ pins show the state of each output.

Connect the oscilloscope probe to OUT_ test points on the **EV kit** to see the output signal in real-time.

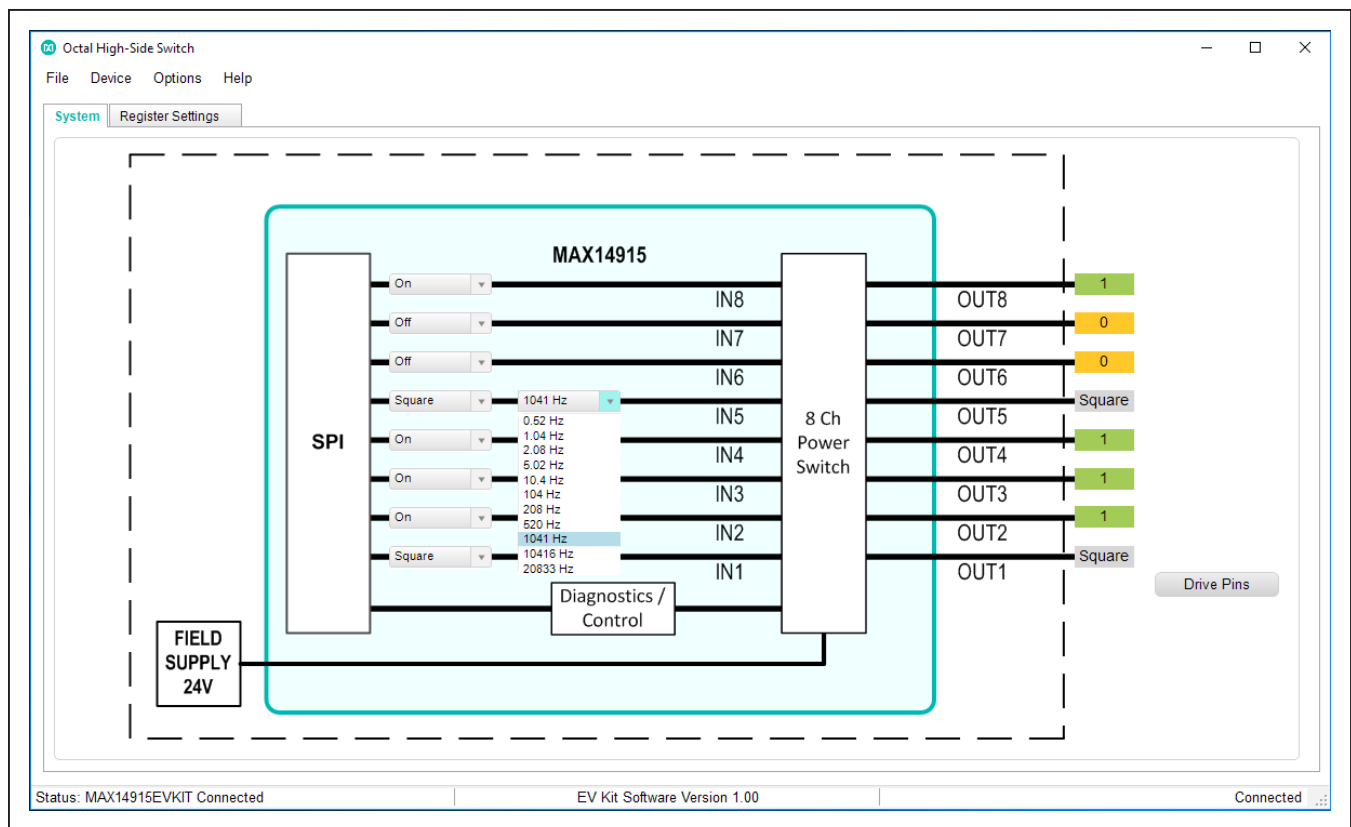

Figure 3. System Tab. Output Configuration

Register Settings Tab

The Register Settings tab allows detailed configuration of the device to explore all the available features, refer to [Figure 4](#). The full register map table of the MAX14915 is located on the left-side of the tab, and the bit-by-bit control and description table is located on the right side. When the register is selected in the register map table, the detailed description of each bit is shown on the right table. The register setting can be changed directly in the register map table by double-clicking on the Value cell. Each data entry should follow by the “Enter/Return” button on the keyboard. The Value cell accepts binary (0b), decimal or hex (0x) numbers. The modified register changes its color from black to red until the data will be actually written to the register. The data in the right table can be changed using drop down menus in the Setting cell for each bit individually. Both tables are synchronized that changes made in one table appear at both tables. There are several write and read options available through the corresponding control buttons located below the register bit-by-bit description table.

When the Auto Write button is selected, any data typed in, or selected through the Setting pull-down menu will be automatically written into the corresponding writable register. The button renamed to Stop Auto Write and auto-write function can be canceled by clicking on this button second time.

When the Auto Read button is selected, the write function is disabled, and the GUI is constantly monitoring the status and fault conditions of the device. Clicking a second time

on the button, which becomes Stop Auto Read, allows canceling this operation.

The Read All button performs a read operation of all registers after each click.

When the fault conditions occur, they will set the bit(s) in the corresponding read-only registers 0x03 to 0x09. The fault condition should be carefully evaluated and removed externally (over/under voltage, overload, open wire, etc.). It is recommended to read Interrupt (0x03) and Global Error (0x09) registers first to identify what kind of fault conditions happened, then read per-channel diagnostic registers 0x04 to 0x08 twice to make sure that condition is gone and to clear interrupts.

The Write Selected button allows to write to the selected register only, while the Write Modified button performs write operation to all modified registers after each click.

There are an I/O pins control and status box and per-bit diagnostic result provided by the MAX14915 after each SPI write or read operation below the buttons. The EN slider allows enable or disable OUTs, CRCEN enables or disables error-detecting code to be added to each SPI transaction and SYNCH slider allows manual synchronization of multiple settings.

A user must match the A0 and A1 jumper position EV kit with the SPI address selected from the Address pulldown menu, located below the register map table. The default address is 00.

Each SPI transaction is displayed in the Device Mode Info box for user convenience.

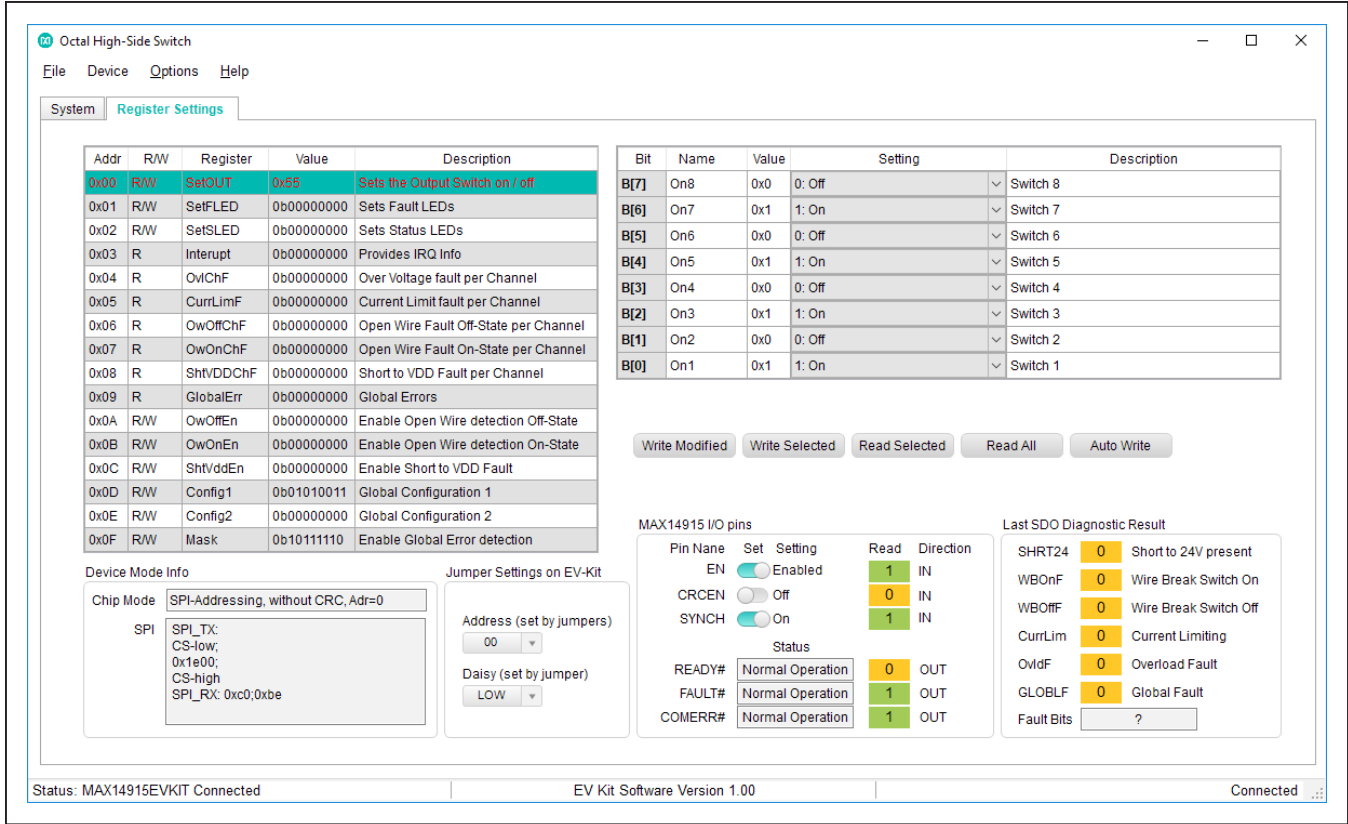

Figure 4. Register Settings Tab

Ordering Information

PART	TYPE
MAX14915EV kit#	EV kit

#Denotes RoHS compliant.

MAX14915 EV Kit Bill of Materials

ITEM	REF_DES	QTY	MFG PART #	MANUFACTURER	VALUE	DESCRIPTION	COMMENTS
1	C1, C10-C16	8	CGA3EANP02A103J080AC	TDK	0.01UF	CAPACITOR; SMT (0603); CERAMIC CHIP; 0.01UF; 100V; TOL=5%; MODEL=MULTILAYER CERAMIC CHIP CAPACITOR; TC=NPO	
2	C5	1	C3225X7S1H106K250AB	TDK	10UF	CAPACITOR; SMT (1210); CERAMIC CHIP; 10UF; 50V; TOL=10%; TG=-55 DEGC TO +125 DEGC; TC=X7S	
3	C6, C9	2	GRM188R72A104KA35; CC0603KRX7R0BB104	MURATA;TDK	0.1UF	CAPACITOR; SMT (0603); CERAMIC CHIP; 0.1UF; 100V; TOL=10%; TG=-55 DEGC TO +125 DEGC; TC=X7R	
4	C7, C17	2	GMK212B7105KG	TAIYO YUDEN	1.0UF	CAPACITOR; SMT (0805); CERAMIC; 1UF; 35V; TOL=10%; MODEL=GMK SERIES; TG=-55 DEGC TO +125 DEGC; TC=X7R	
5	C8	1	CGA4J1X7S1C106K125; GCM21BC71C106KE35	TDK;MURATA	10UF	CAPACITOR; SMT (0805); CERAMIC CHIP; 10UF; 16V; TOL=10%; TG=-55 DEGC TO +125 DEGC; TC=X7S; AUTO	
6	D1	1	SMBJ36A-E3	VISHAY GENERAL SEMICONDUCTOR	36V	DIODE; TVS; SMB (DO-214AA); VRM=36V; IPP=10.3A	
7	DS1-DS8	8	LGL29K-G2J1-24-Z	OSRAM	LGL29K-G2J1-24-Z	DIODE; LED; SMARTLED; GREEN; SMT; PIV=1.7V; IF=0.02A	
8	DS9	1	LTST-C171GKT	LITE-ON ELECTRONICS INC.	LTST-C171GKT	DIODE; LED; STANDARD; GREEN; SMT (0805); PIV=5.0V; IF=0.12A; -55 DEGC TO +85 DEGC	
9	DS10-DS19	10	LS L29K-G1J2-1-Z	OSRAM	LS L29K-G1J2-1-Z	DIODE; LED; SMART; RED; SMT (0603); PIV=1.8V; IF=0.02A; -40 DEGC TO +100 DEGC	
10	J1, J2	2	3267	POMONA ELECTRONICS	3267	CONNECTOR; MALE; PANELMOUNT; STANDARD UNINSULATED BANANA JACK; STRAIGHT; 1PIN	
11	J3-J5	3	PCC02SAAN	SULLINS	PCC02SAAN	CONNECTOR; MALE; THROUGH HOLE; BREAKAWAY; STRAIGHT THROUGH; 2PINS; -65 DEGC TO +125 DEGC	
12	J6, J7	2	PCC03SAAN	SULLINS	PCC03SAAN	CONNECTOR; MALE; THROUGH HOLE; BREAKAWAY; STRAIGHT THROUGH; 3PINS; -65 DEGC TO +125 DEGC	
13	J8, J9	2	OSTTE080104	ON-SHORE TECHNOLOGY INC.	OSTTE080104	CONNECTOR; MALE; THROUGH HOLE; TERMINAL BLOCKS-WIRE TO BOARD; STRAIGHT; 8PINS	
14	J10	1	68021-220HLF	AMPHENOL ICC	68021-220HLF	EVKIT PART-CONNECTOR; MALE; THROUGH HOLE; BERGSTIK II BREAKAWAY HEADER; RIGHT ANGLE; 20PINS;	
15	J11	1	PBC08DAAN	SULLINS ELECTRONICS CORP.	PBC08DAAN	CONNECTOR; MALE; THROUGH HOLE; BREAKAWAY; STRAIGHT; 16PINS; -65 DEGC TO +125 DEGC	
16	J17-J20	4	91772A108; PHILLIPS-PAN_4-40X3/8IN; PMSSS4400038PH; 9901	GENERIC PART	N/A	MACHINE SCREW; PHILLIPS; PAN; 4-40; 3/8IN; 18-8 STAINLESS STEEL	
17	J17-J20	4	MCH_SO_F_HEX_4-40X1/2	GENERIC PART	N/A	STANDOFF; FEMALE-THREADED; HEX; 4-40; 1/2IN; ALUMINUM	
18	OUT1-OUT8	8	5013	KEYSTONE	N/A	TEST POINT; PIN DIA=0.125IN; TOTAL LENGTH=0.445IN; BOARD HOLE=0.063IN; ORANGE; PHOSPHOR BRONZE WIRE SILVER PLATE FINISH;	
19	R1	1	CRCW060324K9FK	VISHAY DALE	24.9K	RESISTOR; 0603; 24.9K OHM; 1%; 100PPM; 0.10W; THICK FILM	
20	R2, R3, R5-R8, R16, R17, R20, R21	10	CRCW06031K00FK; ERJ-3EKF1001V	VISHAY DALE;PANASONIC	1K	RESISTOR; 0603; 1K; 1%; 100PPM; 0.10W; THICK FILM	

MAX14915 EV Kit Bill of Materials (continued)

ITEM	REF_DES	QTY	MFG PART #	MANUFACTURER	VALUE	DESCRIPTION	COMMENTS
21	R4	1	CRCW0603162KFK	VISHAY DALE	162K	RESISTOR; 0603; 162K OHM; 1%; 100PPM; 0.1W; THICK FILM	
22	R10	1	ERJ-3EKF28R0V	PANASONIC	28	RESISTOR; 0603; 28 OHM; 1%; 100PPM; 0.10W; THICK FILM	
23	R12-R15	4	CRCW06035K60FK	VISHAY DALE	5.6K	RESISTOR; 0603; 5.6K OHM; 1%, 100PPM; 0.10W; THICK FILM	
24	R18, R19	2	CRCW060310K0FK; ERJ-3EKF1002	VISHAY DALE;PANASONIC	10K	RESISTOR; 0603; 10K; 1%; 100PPM; 0.10W; THICK FILM	
25	SU1, SU2, SU4-SU6	5	S1100-B;SX1100-B	KYCON;KYCON	SX1100-B	TEST POINT; JUMPER; STR; TOTAL LENGTH=0.24IN; BLACK; INSULATION=PBT;PHOSPHOR BRONZE CONTACT=GOLD PLATED	
26	VA, VL, TP1, VLED	4	5010	KEYSTONE	N/A	TESTPOINT WITH 1.80MM HOLE DIA, RED, MULTIPURPOSE;	
27	TP2, TP4, TP11, TP20-TP22	6	5011	KEYSTONE	N/A	TEST POINT; PIN DIA=0.125IN; TOTAL LENGTH=0.445IN; BOARD HOLE=0.063IN; BLACK; PHOSPHOR BRONZE WIRE SILVER PLATE FINISH;	
28	TP6, TP9	2	5009	KEYSTONE	N/A	TEST POINT; PIN DIA=0.125IN; TOTAL LENGTH=0.35IN; BOARD HOLE=0.063IN; YELLOW; PHOSPHOR BRONZE WIRE SILVER PLATE FINISH;	
29	TP12-TP15	4	5004	KEYSTONE	N/A	TEST POINT; PIN DIA=0.1IN; TOTAL LENGTH=0.3IN; BOARD HOLE=0.04IN; YELLOW; PHOSPHOR BRONZE WIRE SILVER PLATE FINISH;	
30	U1	1	MAX14915	MAXIM	MAX14915	EVKIT PART-IC; SWTC; OCTAL HIGH-SIDE SWITCH WITH DIAGNOSTIC; FCQFN48-EP; PACKAGE OUTLINE: 21-100232; PACKAGE LAND PATTERN: 90- 100077	
31	PCB	1	MAX	MAXIM	PCB	PCB:MAX	-
TOTAL		103					

MAX14915 EV Kit Schematic

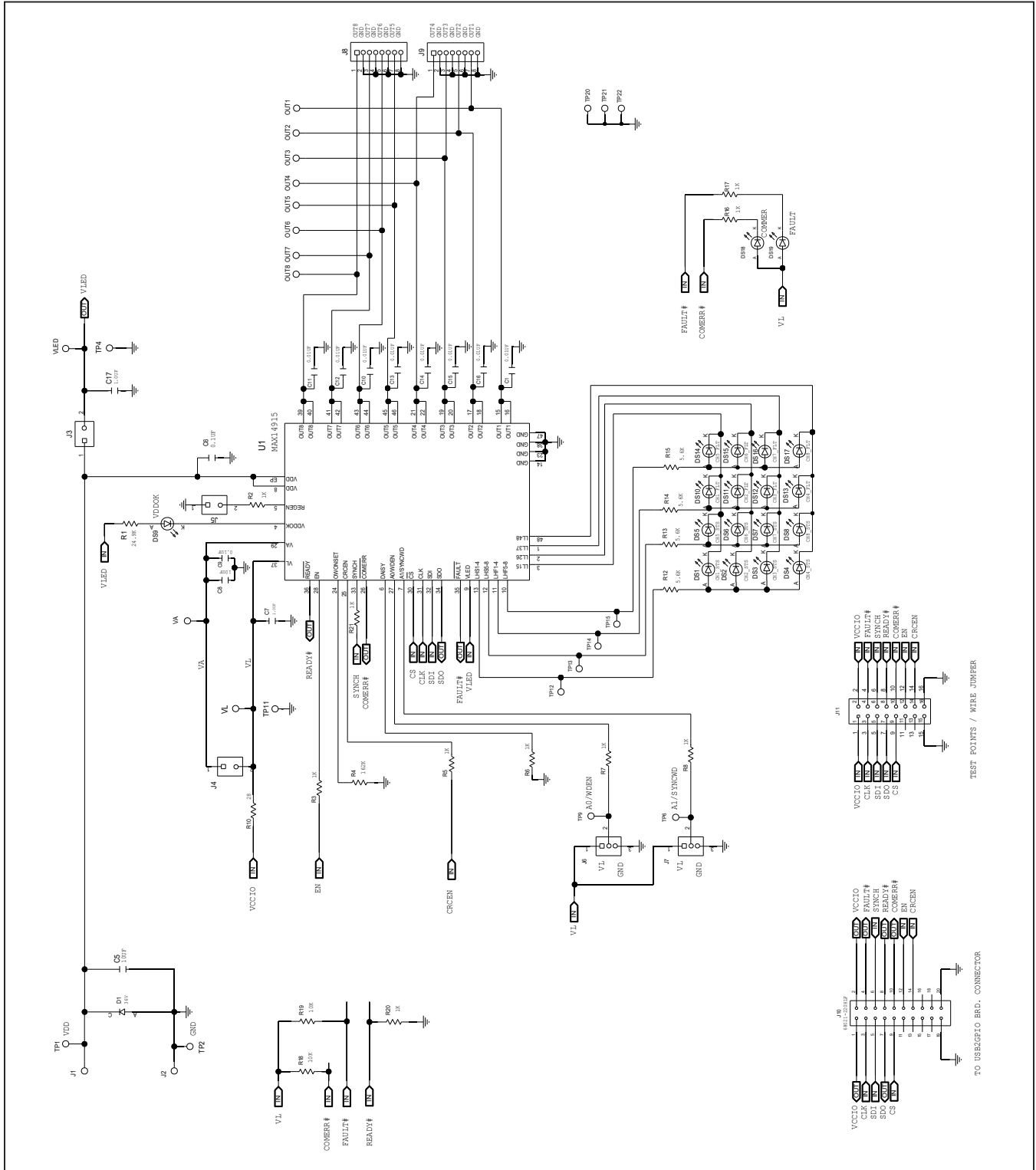

MAX14915 EV Kit PCB Layout Diagrams

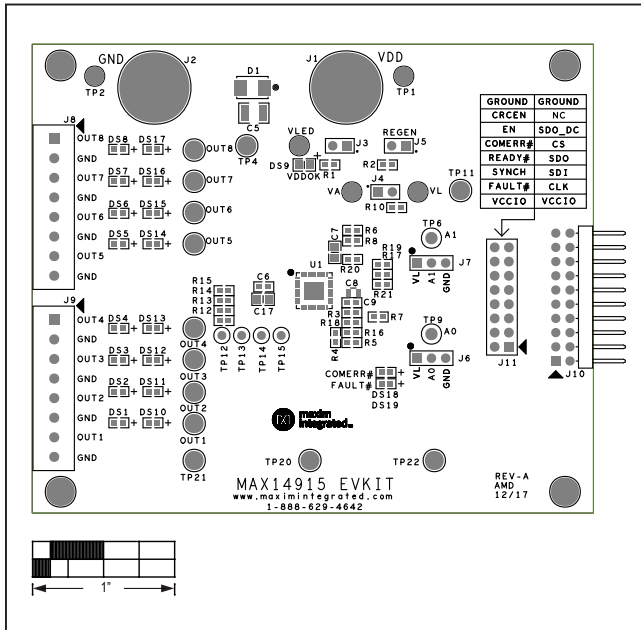

MAX14915 EV Kit—Silk Top

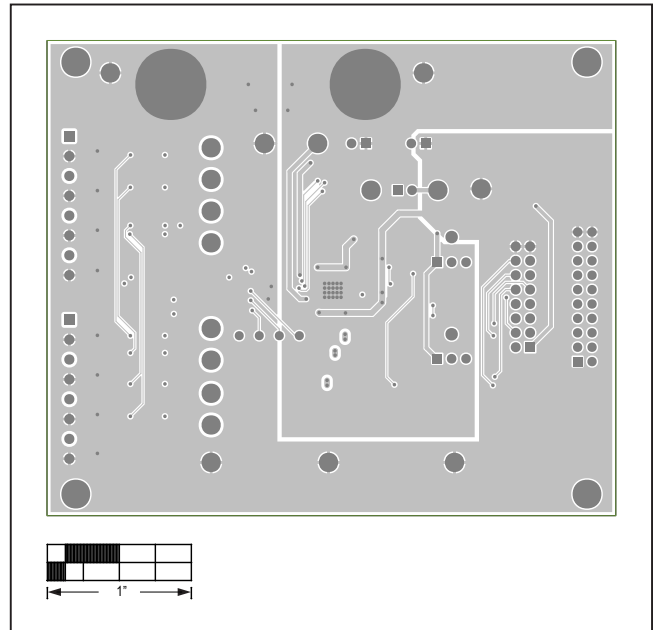

MAX14915 EV Kit—Internal 2

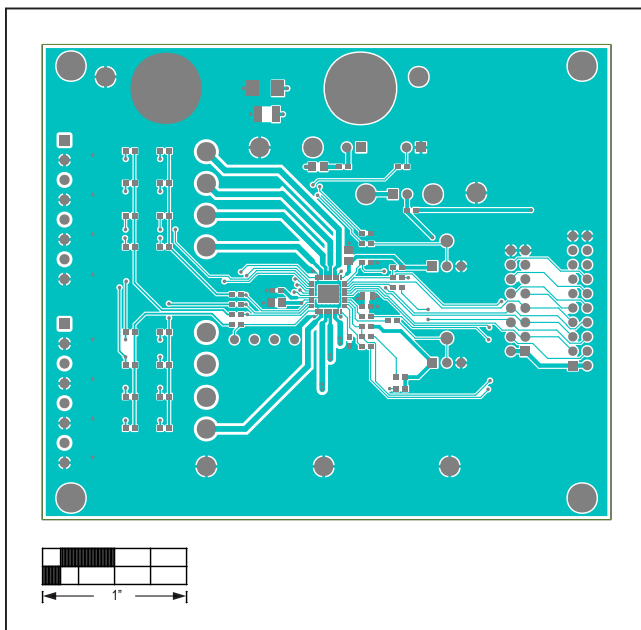

MAX14915 EV Kit—Top

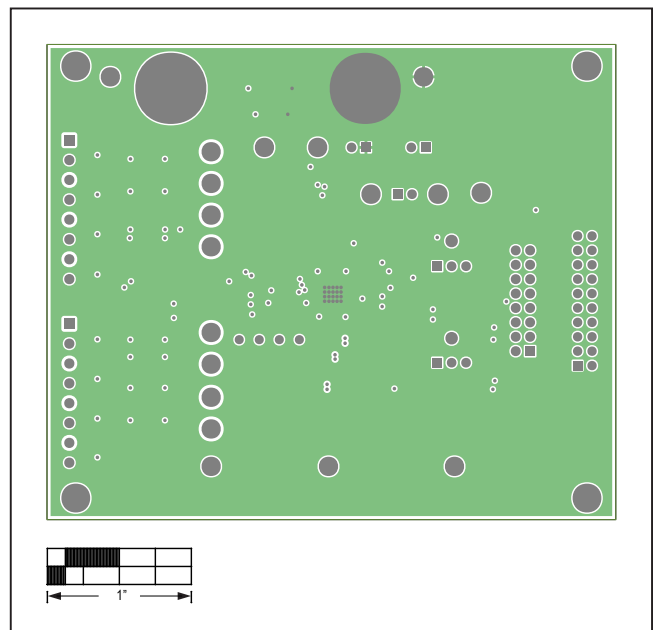

MAX14915 EV Kit—Internal 3

MAX14915 EV Kit PCB Layout Diagrams (continued)

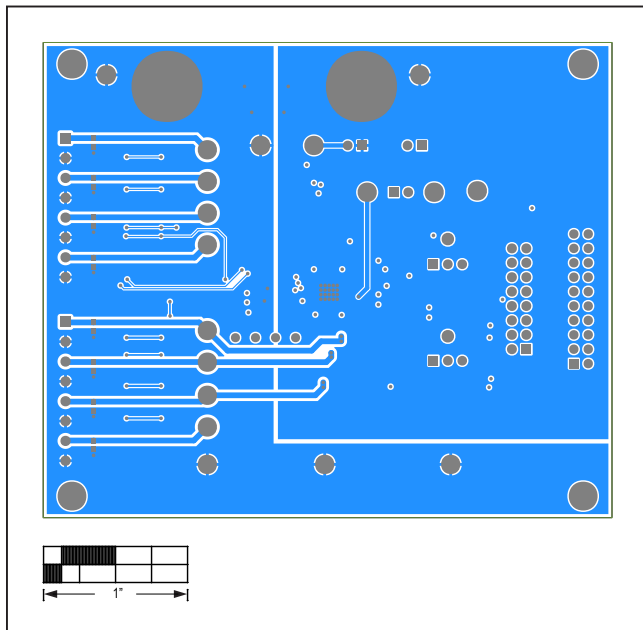

MAX14915 EV Kit—Bottom

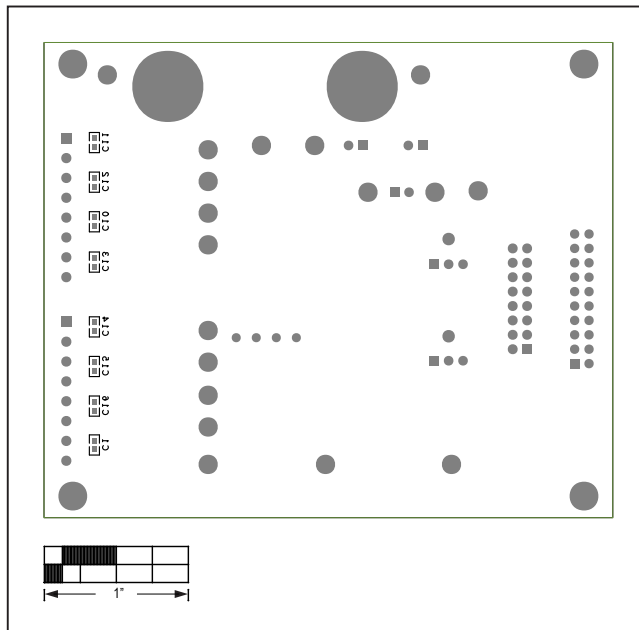

MAX14915 EV Kit—Bottom Silkscreen

Revision History

REVISION NUMBER	REVISION DATE	DESCRIPTION	PAGES CHANGED
0	9/18	Initial release	—

For pricing, delivery, and ordering information, please visit Maxim Integrated's online storefront at <https://www.maximintegrated.com/en/storefront/storefront.html>.

Maxim Integrated cannot assume responsibility for use of any circuitry other than circuitry entirely embodied in a Maxim Integrated product. No circuit patent licenses are implied. Maxim Integrated reserves the right to change the circuitry and specifications without notice at any time.

X-ON Electronics

Largest Supplier of Electrical and Electronic Components

Click to view similar products for [Power Management IC Development Tools](#) category:

Click to view products by [Maxim](#) manufacturer:

Other Similar products are found below :

[EVB-EP5348UI](#) [MIC23451-AAAYFL EV](#) [MIC5281YMME EV](#) [124352-HMC860LP3E](#) [DA9063-EVAL](#) [ADP122-3.3-EVALZ](#) [ADP130-0.8-EVALZ](#) [ADP130-1.8-EVALZ](#) [ADP1740-1.5-EVALZ](#) [ADP1870-0.3-EVALZ](#) [ADP1874-0.3-EVALZ](#) [ADP199CB-EVALZ](#) [ADP2102-1.25-EVALZ](#) [ADP2102-1.875EVALZ](#) [ADP2102-1.8-EVALZ](#) [ADP2102-2-EVALZ](#) [ADP2102-3-EVALZ](#) [ADP2102-4-EVALZ](#) [AS3606-DB](#) [BQ25010EVM](#) [BQ3055EVM](#) [ISLUSBI2CKIT1Z](#) [LP38512TS-1.8EV](#) [EVAL-ADM1186-1MBZ](#) [EVAL-ADM1186-2MBZ](#) [ADP122UJZ-REDYKIT](#) [ADP166Z-REDYKIT](#) [ADP170-1.8-EVALZ](#) [ADP171-EVALZ](#) [ADP1853-EVALZ](#) [ADP1873-0.3-EVALZ](#) [ADP198CP-EVALZ](#) [ADP2102-1.0-EVALZ](#) [ADP2102-1-EVALZ](#) [ADP2107-1.8-EVALZ](#) [ADP5020CP-EVALZ](#) [CC-ACC-DBMX-51](#) [ATPL230A-EK](#) [MIC23250-S4YMT EV](#) [MIC26603YJL EV](#) [MIC33050-SYHL EV](#) [TPS60100EVM-131](#) [TPS65010EVM-230](#) [TPS71933-28EVM-213](#) [TPS72728YFFEVM-407](#) [TPS79318YEQEVM](#) [UCC28810EVM-002](#) [XILINXPWR-083](#) [LMR22007YMINI-EVM](#) [LP38501ATJ-EV](#)