

## MAX15157B Evaluation Kit

Evaluates: MAX15157B

### General Description

The MAX15157B evaluation kit (EV kit) is a fully assembled and tested circuit board that contains all components necessary to evaluate the performance of the MAX15157B. The device is a high-efficiency step-down and/or step-up regulator. The EV kit is powered from a 15V to 60V DC supply. It is capable of delivering from 5V to 32V at 15A or 200W (max) and at a 600kHz switching frequency. Refer to the MAX15157B data sheet to set the switching frequency and input/output voltage ranges for the EV kit.

### Features

- 15V to 60V Input-Voltage Range (Changeable from 8V to 60V)
- 5V to 32V Output-Voltage Range (Changeable from 3V to 52V)
- Adjustable Slope Compensation Ramp
- Precision High-Side Current Sense for Output Current Monitor
- Multiphase Operation Up to 4 Phases
- Adjustable Switching Frequency: 120kHz to 1MHz Range
- External Switching Frequency Clock Synchronization
- External REFIN Input for Output Adjustment
- Hiccup Fault Protection for Overcurrent
- Thermal Shutdown
- POW-OK Output (Power-Good Output)
- Adjustable Input UVLO, and Output OVP Voltage
- Adjustable Soft-Start, and Soft-Stop
- Monotonic Startup into Prebiased Output

**Ordering Information** appears at end of data sheet.

### Quick Start

#### Recommended Equipment

- MAX15157B EV kit
- 8V to 60V, 10A DC power supply V1 (for VIN)
- 2V, 100mA DC power supply V2 (for external reference input connected to REFIN)
- Loads capable of sinking 10A
- Five digital voltmeters (DVM)
- Function generator, square wave 0V–5V at frequency range from 200kHz to 2MHz
- 100MHz dual-trace oscilloscope

#### Procedure

The EV kit is fully assembled and tested. Follow the steps below to verify board operation. **Caution: Do not turn on the power supply until all connections are completed.**

- 1) Install a shunt across pins 1-2 of jumper JU1 (external reference to REFIN for FB tracking mode).
- 2) Install shunts at jumpers JU10 and JU11 (DRV = 8.8V on board from VIN).
- 3) Leave the following jumpers open (no shunts): JU2 to JU9.
- 4) With power supplies off:
  - a) Connect the positive terminal of the power supply V1 to the VIN connector and the negative terminal of the power supply to the PGND connector, which is near the VIN connector.
  - b) Connect the positive terminal of the power supply V2 to REFINX, and the negative terminal to AGND, which is near REFINX.
- 5) Connect a 5A electronic load to the VOUT and PGND banana jack connectors and disable the load.
- 6) Reference to PGND, connect five voltmeters to VOUT, VDRV, ENABLE, TP11 (4V6\_BIAS), and POW-OK (power good).

- 7) Power on:
- a) Turn both V1 (VIN) and V2 (REFINX) on at 0V.
  - b) Ramp up VIN to 13V, check VDRV for 8.8V (powered by U2), and ENABLE > 0.7V (EN threshold).
  - c) Ramp up VIN to 30V or higher, UVLO should exceed 1V (threshold), and 4V6 pin (TP11) is around 4.55V.
  - d) Ramp REFINX from 0V to 1.05V, VOUT is approximately 16.8V, and POW-OK (power good) about 4.55V (same voltage level as TP11).

### Detailed Description of Hardware

The MAX15157B EV kit is a fully assembled and tested board to evaluate the performance of the MAX15157B at 150W synchronous step-down and/or step-up regulator. With the wide range of input and output voltage (input from 8V to 60V, and output from 3V to 0.94% of input), the MAX15157B is well suited for telecommunication and industrial equipment applications.

### Regulator Enable (EN)

The MAX15157B features a shutdown mode to minimize the IC quiescent current. To shut down the IC, pull EN below 0.55V or install a shunt on the jumper JU3.

**Table 1. Default Setting of MAX15157B EV Kit**

JUMPER	SHUNT POSITION	FUNCTION
JU1	1-2	Output tracking mode: set external voltage to REFINX
JU2 to JU9	Open	
JU10, JU11	1-2	Using U2 = MAX17552 on board to provide 8.8V for DRV

**Table 3. Reference Voltage (JU1)**

SHUNT POSITION	REFIN PIN CONNECTION	REFERENCE VOLTAGE	VOUT RANGE
1-2 (Tracking mode)	To external Voltage (at REFINX)	User-supplied reference voltage Range: 1.05V to 2V	VOUT = 16.8V to 32V (Increase R7 to get the higher VOUT)
2-3 (Preset mode)	To BIAS 4V6 pin	Internal 2V reference	VOUT = 32V (Increase R7 to get the higher VOUT)

### Reference Voltage (REFIN)

The MAX15157B uses an internal 2V reference or an external reference input. The IC regulates FB to the internal 2V or external voltage at REFINX, as shown at [Table 3](#).

### Switching Frequencies (FREQ/CLK)

The controller supports 120kHz to 1MHz switching frequencies. The EV kit comes preset at a 600kHz switching frequency with the CLOCKIN (FREQ/CLK) unconnected. To adjust the switching frequency, either replace resistor R3 (connected from FREQ/CLK to GND) by using the following equation:

$$f_{SW} = (R_3/100k\Omega) \times 600kHz$$

or drive the FREQ/CLK (CLOCKIN) with an external clock at twice speed of the switching frequency (it is not necessary to remove R3 when applying the external clock).

### Configuring the Output Voltage (VOUT)

VOUT voltage can be set between 3V to 0.94 x VIN, and externally programmed by using the following equation:

$$VOUT = V_{REFINX} \times (R7 + R8)/R8$$

where VREFINX is the reference voltage in [Table 3](#) (2V for preset mode, 1.05V to 2V for tracking mode).

**Table 2. Regulator Enable (JU3)**

SHUNT POSITION	EN PIN CONNECTION	MAX15157B FUNCTION
Not installed	Pull up to DRV through R4	Enabled
Installed	GND	Disabled

### Soft-Start (SS)

The MAX15157B offers the SS pin to adjust soft-start time to limit inrush current during startup. Soft-start times are controlled by C13 for VOUT. An internal 5µA current source charges the capacitor at the SS pin to provide a linear ramping voltage for the output voltage reference. The soft-start time of VOUT is calculated based on the following equation:

$$t_{SS} = C13 \times V_{REFINX} / 5\mu A$$

where  $V_{REFINX}$  is the reference voltage in [Table 3](#) (2V for preset mode, 1.05V to 2V for tracking mode).

Note that during the initialization, the SS pin is held low until UVLO exceeds its threshold voltage of 1V. The drivers start switching once SS exceeds 50mV, and the controller enables the fault-protection circuitry when SS exceeds 1V.

### Current-Limit Thresholds and Current Monitor

The low- and high-side current sensing can be set by R1 and R2, respectively. R1 is used for cycle-by-cycle current limit threshold. R2 is used for current monitor at a slower control loop. Refer to the *Output Fault Protection* section of MAX15157B data sheet for calculating the resistor R1 value and the *Current Monitor* section for the R2 resistor value.

### POW-OK (Power Good)

The MAX15157B EV kit provides the POW-OK output (power-good output) test point. The POW-OK signal is pulled up to the 4V6 BIAS by resistor R9, and POW-OK is high when VOUT is above 90% of its programmed output voltage. When VOUT is below 90% of its programmed output voltage, POW-OK is pulled low.

### Ordering Information

PART	TYPE
MAX15157BEVKIT#	EV Kit

#Denotes RoHS compliant.

MAX15157B EV Kit Bill of Materials

ITEM	QTY	REF DES	MFG PART #	MANUFACTURER	VALUE	DESCRIPTION
1	8	AGND, CLOCKIN, ENABLE, GND, IREP, POW-OK, REFINX, VDRV	9020 BUSS	WEICO WIRE	MAXIMPAD	EVK KIT PARTS; MAXIM PAD; WIRE; NATURAL; SOLID; WEICO WIRE; SOFT DRAWN BUS TYPE-S; 20AWG
2	42	C0-C4, C7, C8, C34-C48, C60-C79	C5750X7S2A106M230KB	TDK	10UF	CAPACITOR; SMT (2220); CERAMIC CHIP; 10UF; 100V; TOL=20%; MODEL=; TG=-55 DEGC TO +125 DEGC; TC=X7S
3	2	C5, C6	EEE-FK1H221P	PANASONIC	220UF	CAPACITOR; SMT (CASE_G); ALUMINUM-ELECTROLYTIC; 220UF; 50V; TOL=20%; MODEL=FK SERIES; TG=-55 DEGC TO +105 DEGC
4	3	C9, C10, C58	EEV-FK1K151Q	PANASONIC	150UF	CAPACITOR; SMT (CASE_H13); ALUMINUM-ELECTROLYTIC; 150UF; 80V; TOL=20%; MODEL=; TG=-55 DEGC TO +105 DEGC
5	1	C11	GRM188R71H683KA93	MURATA	0.068UF	CAP; SMT (0603); 0.068UF; 10%; 50V; X7R; CERAMIC CHIP
6	1	C12	GRM1885C1H121JA01	MURATA	120PF	CAPACITOR; SMT (0603); CERAMIC CHIP; 120PF; 50V; TOL=5%; TG=-55 DEGC TO +125 DEGC; TC=COG
7	1	C13	C1608X5R1H104K080AA	TDK	0.1UF	CAPACITOR; SMT (0603); CERAMIC CHIP; 0.1UF; 50V; TOL=10%; MODEL=C SERIES; TG=-55 DEGC TO +85 DEGC; TC=X5R
8	5	C14, C19-C22	C0603X7R500103JNP; C0603C103J5RAC	VENKEL LTD; KEMET	0.01UF	CAPACITOR; SMT (0603); CERAMIC CHIP; 0.01UF; 50V; TOL=5%; MODEL=X7R; TG=-55 DEGC TO +125 DEGC; TC=+/-
9	4	C17, C18, C24, C26	UMK107AB7105KA; CC0603KRX7R9BB105	TAIYO YUDEN; YAGEO	1UF	CAPACITOR; SMT (0603); CERAMIC CHIP; 1UF; 50V; TOL=10%; TG=-55 DEGC TO +125 DEGC; TC=X7R
10	1	C23	GRM188R71E474KA12; GCM188R71E474KA64	MURATA; MURATA	0.47UF	CAPACITOR; SMT (0603); CERAMIC CHIP; 0.47UF; 25V; TOL=10%; MODEL=GRM SERIES; TG=-55 DEGC TO +125 DEGC; TC=X7R
11	1	C25	EEE-FK2A220P	PANASONIC	22UF	CAPACITOR; SMT (CASE_F); ALUMINUM-ELECTROLYTIC; 22UF; 100V; TOL=20%; MODEL=EEV SERIES; TG=-55 DEGC TO +105 DEGC
12	3	C27, C56, C57	GRM1885C1H102JA01; C1608C0G1H102J080AA; GCM1885C1H102JA16	MURATA; TDK; MURATA	1000PF	CAPACITOR; SMT (0603); CERAMIC CHIP; 1000PF; 50V; TOL=5%; TG=-55 DEGC TO +125 DEGC
13	2	C28, CX1	C0805C104K1RAC; C2012X7R2A104K125AA; GCM21BR72A104KA37; GRM21BR72A104KAC4; CGA4J2X7R2A104K125AA	KEMET; TDK; MURATA; MURATA; TDK	0.1UF	CAPACITOR; SMT (0805); CERAMIC CHIP; 0.1UF; 100V; TOL=10%; TG=-55 DEGC TO +125 DEGC; TC=X7R
14	1	C49	GRM31CR72A105KA01; C3216X7R2A105K160AA; GCH31CR72A105KE01; HMK316B7105KLH	MURATA; TDK; MURATA; TAIYO YUDEN	1UF	CAPACITOR; SMT; 1206; CERAMIC; 1uF; 100V; 10%; X7R; 55 DEGC TO +125 DEGC
15	1	C50	GRM155R71C224KA12	MURATA	0.22UF	CAPACITOR; SMT (0402); CERAMIC; 0.22UF; 16V; TOL=10%; MODEL=GRM SERIES; TG=-55 DEGC TO +125 DEGC; TC=X7R

MAX15157B EV Kit Bill of Materials (continued)

ITEM	QTY	REF DES	MFG PART #	MANUFACTURER	VALUE	DESCRIPTION
16	2	C51, C52	GRM219R6YA475KA73	MURATA	4.7UF	CAPACITOR; SMT (0805); CERAMIC CHIP; 4.7UF; 35V; TOL=10%; TG=-55 DEGC TO +85 DEGC; TC=X5R
17	1	C54	C0603C100J5GAC; GRM1885C1H100JA01; 06035A100JAT2A	KEMET; MURATA; AVX	10PF	CAPACITOR; SMT; 0603; CERAMIC; 10pF; 50V; 5%; COG; -55degC to +125degC, USE 20-0010p-E4 FOR NEW DESIGN
18	1	C59	CL05B102K05NNN; C0402C102K4RAC	SAMSUNG; KEMET	1000PF	CAPACITOR; SMT (0402); CERAMIC; 1000PF; 16V; TOL=10%; TG=-55 DEGC TO +125 DEGC; TC=X7R
19	1	D2	BAS21J	NXP	BAS21J	DIODE; SS; GENERAL PURPOSE DIODE; SMT (SOD-323); PIV=300V; IF=0.25A
20	1	D4	SMBJ100A	LITTELFUSE	100V	DIODE; TVS; SMB (DO-214AA); VRM=100V; IPP=3.7A
21	3	J1-J3	LS2-110-01-S-D-RA1	SAMTEC	LS2-110-01-S-D-RA1	CONNECTOR; THROUGH HOLE; SELF MATING HERMAPHRODITIC STRIP SHROUD DOWN; RIGHT ANGLE; 20PINS
22	4	J3-1, J3-2, J4-1, J4-2	111-2223-001	EMERSON NETWORK POWER	111-2223-001	MACHINE SCREW; THUMBSCREW; BANANA; 1/4-32IN; 11/32IN; NICKEL PLATED BRASS
23	3	J4, J6, J7	LS2-110-01-S-D-RA2	SAMTEC	LS2-110-01-S-D-RA2	CONNECTOR; THROUGH HOLE; SELF MATING HERMAPHRODITIC STRIP SHROUD UP; RIGHT ANGLE; 20PINS
24	4	JU1, JU4, JU8, JU9	PEC03SAAN	SULLINS	PEC03SAAN	CONNECTOR; MALE; THROUGH HOLE; BREAKAWAY; STRAIGHT; 3PINS
25	4	JU3, JU7, JU10, JU11	PEC02SAAN	SULLINS	PEC02SAAN	CONNECTOR; MALE; THROUGH HOLE; BREAKAWAY; STRAIGHT; 2PINS
26	1	L1	SER2915H-472KL	COILCRAFT	4.7UH	INDUCTOR; SMT; FERRITE CORE; 4.7UH; TOL=+/-10%; 30A
27	1	L2	LPS5030-154MR	COILCRAFT	150UH	INDUCTOR; SMT; SHIELDED; 150UH; TOL=+/-20%; 0.57A
28	2	M1, M2	BSC037N08NS5ATMA1	INFINEON	BSC037N08NS5ATMA1	TRAN; NCH; PG-TDSON8; PD-(114W); I-(100A); V-(80V)
29	4	MH1-MH4	9032	KEYSTONE	9032	MACHINE FABRICATED; ROUND-THRU HOLE SPACER; NO THREAD; M3.5; 5/8IN; NYLON
30	1	Q1	IRLR3110ZTRPBF	INTERNATIONAL RECTIFIER	IRLR3110ZTRPBF	TRAN; HEXFET POWER MOSFET; NCH; DPAK; PD-(140W); I-(63A); V-(100V)
31	1	R1	WSL25121L000F	VISHAY DALE	0.001	RESISTOR; 2512; 0.001 OHM; 1%; 275PPM; 1.0W; METAL FILM
32	1	R3	CRCW060341K2FK	VISHAY DALE	41.2K	RESISTOR; 0603; 41.2K OHM; 1%; 100PPM; 0.10W; METAL FILM
33	1	R4	CRCW0603100KFK; RC0603FR-07100KL; RC0603FR-13100KL; ERJ-3EKF1003; AC0603FR-07100KL	VISHAY DALE; YAGEO; YAGEO; PANASONIC; YAGEO	100K	RESISTOR; 0603; 100K; 1%; 100PPM; 0.10W; THICK FILM
34	3	R7, R12, R15	CRCW060310K0FK; ERJ-3EKF1002	VISHAY DALE; PANASONIC	10K	RESISTOR; 0603; 10K; 1%; 100PPM; 0.10W; THICK FILM
35	1	R8	CRCW06032K0FK; ERJ-3EKF2001	VISHAY DALE; PANASONIC	2K	RESISTOR; 0603; 2K OHM, 1%, 100PPM, 0.10W, THICK FILM
36	2	R9, R19	ERJ-3GEYJ104; CRCW0603100KJN	PANASONIC; VISHAY	100K	RESISTOR; 0603; 100K OHM; 5%; 200PPM; 0.10W; THICK FILM
37	1	R10	CRCW0603270KFK;ERJ-3EKF2703	VISHAY DALE; PANASONIC	270K	RESISTOR; 0603; 270K; 1%; 100PPM; 0.10W; THICK FILM
38	7	R11, R37, R38, R48-R51	RC1608J000CS; CR0603-J/-000ELF; RC0603JR-070RL	SAMSUNG; BOURNS; YAGEO PH	0	RESISTOR; 0603; 0 OHM; 5%; JUMPER; 0.10W; THICK FILM

MAX15157B EV Kit Bill of Materials (continued)

ITEM	QTY	REF DES	MFG PART #	MANUFACTURER	VALUE	DESCRIPTION
39	1	R13	CRCW0603191KFK	VISHAY DALE	191K	RESISTOR; 0603; 191K OHM; 1%; 100PPM; 0.10W; METAL FILM
40	1	R14	CRCW060360K4FK	VISHAY DALE	60.4K	RESISTOR, 0603, 60.4KOHMS, 1%, 100PPM, 0.1W, THICK FILM
41	1	R16	CRCW060315K0FK	VISHAY DALE	15K	RESISTOR, 0603, 15K OHM,1%, 100PPM, 0.10W, THICK FILM
42	2	R17, R20	ERJ-3GEYJ102	PANASONIC	1K	RESISTOR; 0603; 1K OHM; 5%; 200PPM; 0.10W; THICK FILM
43	1	R18	CRCW06031K18FK; ERJ-3EKF1181	VISHAY DALE; PANASONIC	1.18K	RESISTOR; 0603; 1.18K OHM; 1%; 100PPM; 0.10W; THICK FILM
44	4	R21, R22, R25, R30	ERJ-3GEYJ100	PANASONIC	10	RESISTOR; 0603; 10 OHM; 5%; 200PPM; 0.10W; THICK FILM
45	2	R23, R24	CRCW08054R70FK	VISHAY DALE	4.7	RESISTOR; 0805; 4.7 OHM; 1%; 100PPM; 0.125W; THICK FILM
46	1	R34	CRCW060310R0FK; MCR03EZPFX10R0; ERJ-3EKF10R0	VISHAY DALE; ROHM; PANASONIC	10	RESISTOR; 0603; 10 OHM; 1%; 100PPM; 0.10W; THICK FILM
47	1	R35	CRCW04023M01FK	VISHAY DALE	3.01M	RESISTOR; 0402; 3.01M OHM; 1%; 100PPM; 0.063W; METAL FILM
48	1	R36	ERJ-3EKF5902	PANASONIC	59K	RESISTOR; 0603; 59K OHM; 1%; 100PPM; 0.1W; THICK FILM
49	1	R39	CRCW0402432KFK	VISHAY DALE	432K	RESISTOR; 0402; 432K OHM; 1%; 100PPM; 0.063W; THICK FILM
50	1	R40	CRCW0402110KFK	VISHAY DALE	110K	RESISTOR; 0402; 110K OHM; 1%; 100PPM; 0.063W; THICK FILM
51	1	R42	CRCW0402287KFK	VISHAY DALE	287K	RESISTOR, 0402, 287K OHM, 1%, 100PPM, 0.0625W, THICK FILM
52	1	R43	TNPW040224K9BE	VISHAY	24.9K	RES; SMT (0402); 24.9K; 0.1%; +/-25PPM/DEGC; 0.1W
53	1	R44	CR0603-16W-5492FT	VENKEL LTD.	54.9K	RESISTOR; 0603; 54.9K OHM; 1%; 100PPM; 0.063W; THICK FILM
54	1	R53	WSL25123L000F	VISHAY DALE	0.003	RESISTOR; 2512; 0.003 OHM; 1%; 150PPM; 1.0W; METAL FILM
55	8	SU1-SU8	S1100-B; SX1100-B; STC02SYAN	KYCON; KYCON; SULLINS	SX1100-B	TEST POINT; JUMPER; STR; TOTAL LENGTH=0.24IN; BLACK; INSULATION=PBT;PHOSPHOR BRONZE CONTACT=GOLD PLATED
56	10	TP1, TP2, TP4-TP7, TP11, TP12, TP15, TP16	5000	KEYSTONE	N/A	TEST POINT; PIN DIA=0.1IN; TOTAL LENGTH=0.3IN; BOARD HOLE=0.04IN; RED; PHOSPHOR BRONZE WIRE SILVER PLATE FINISH; RECOMMENDED FOR BOARD THICKNESS=0.062IN; NOT FOR COLD TEST
57	1	U1	MAX15157BATJ+	MAXIM	MAX15157BATJ+	IC; CTRL; CURRENT MODE BUCK CONTROLLER WITH ACCURATE CURRENT REPORT; TQFN32-EP
58	1	U2	MAX17552AUB+	MAXIM	MAX17552AUB+	IC; CONV; 60V; 100MA; ULTRA-SMALL; HIGH EFFICIENCY; SYNCHRONOUS STEP-DOWN DC-DC CONVERTER WITH 22UA NO-LOAD SUPPLY CURRENT; UMAX10
59	1	PCB	MAX15157B	MAXIM	PCB	PCB:MAX15157B

TOTAL 168

MAX15157B EV Kit Schematic

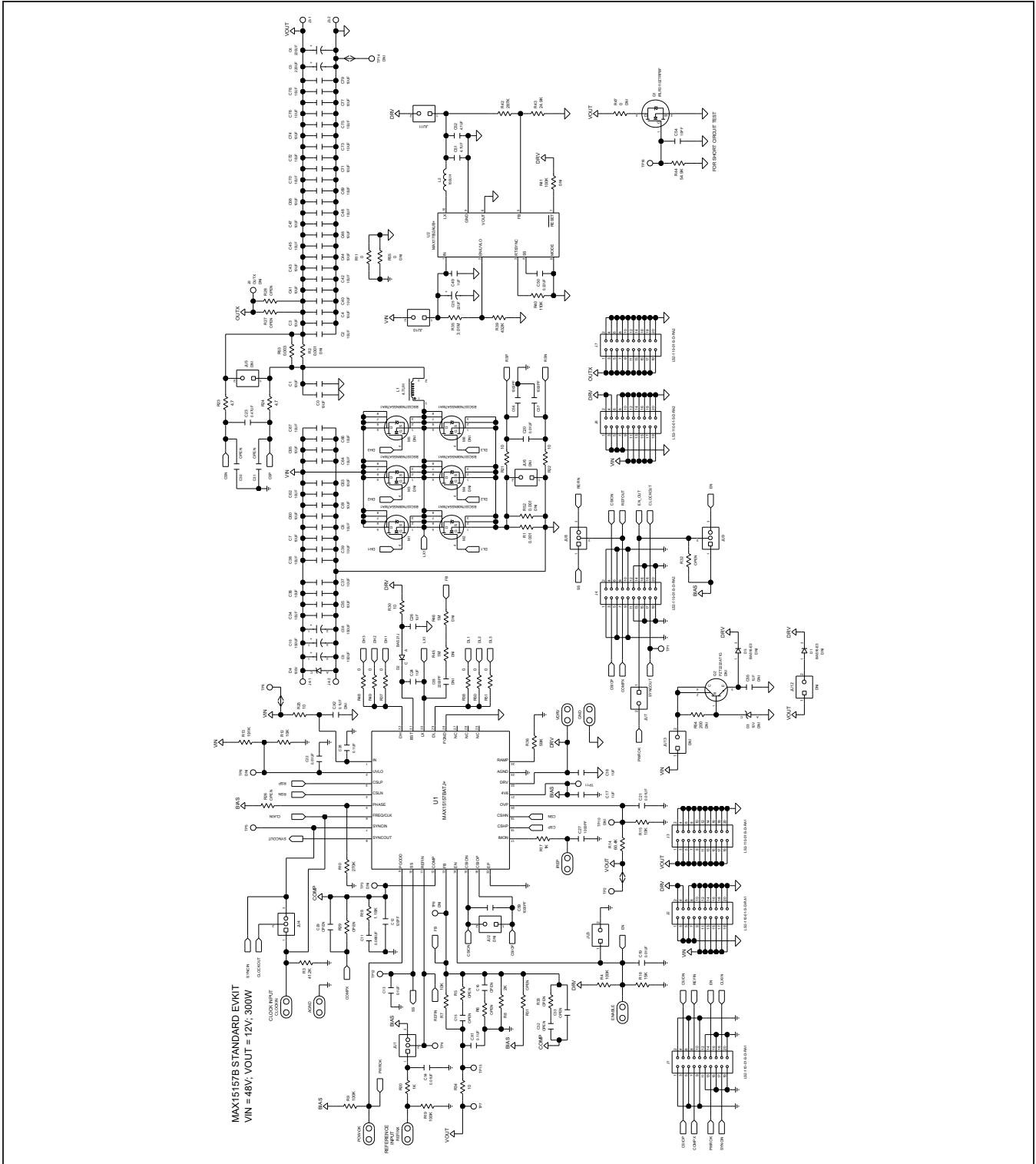

MAX15157B EV Kit PCB Layout Diagrams

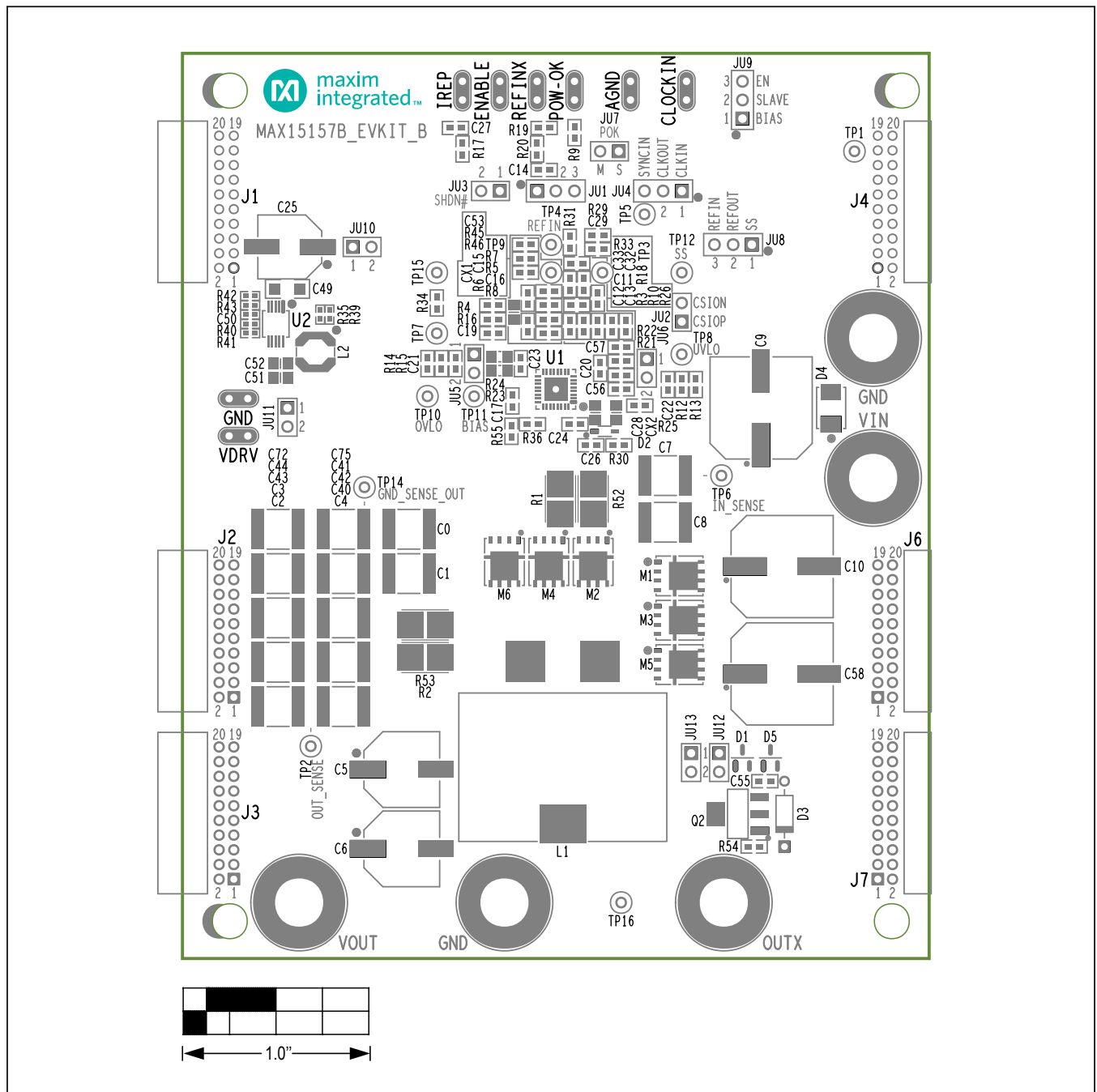

MAX15157B EV Kit PCB Silkscreen Top Side





MAX15157B EV Kit PCB Layout Diagrams (continued)

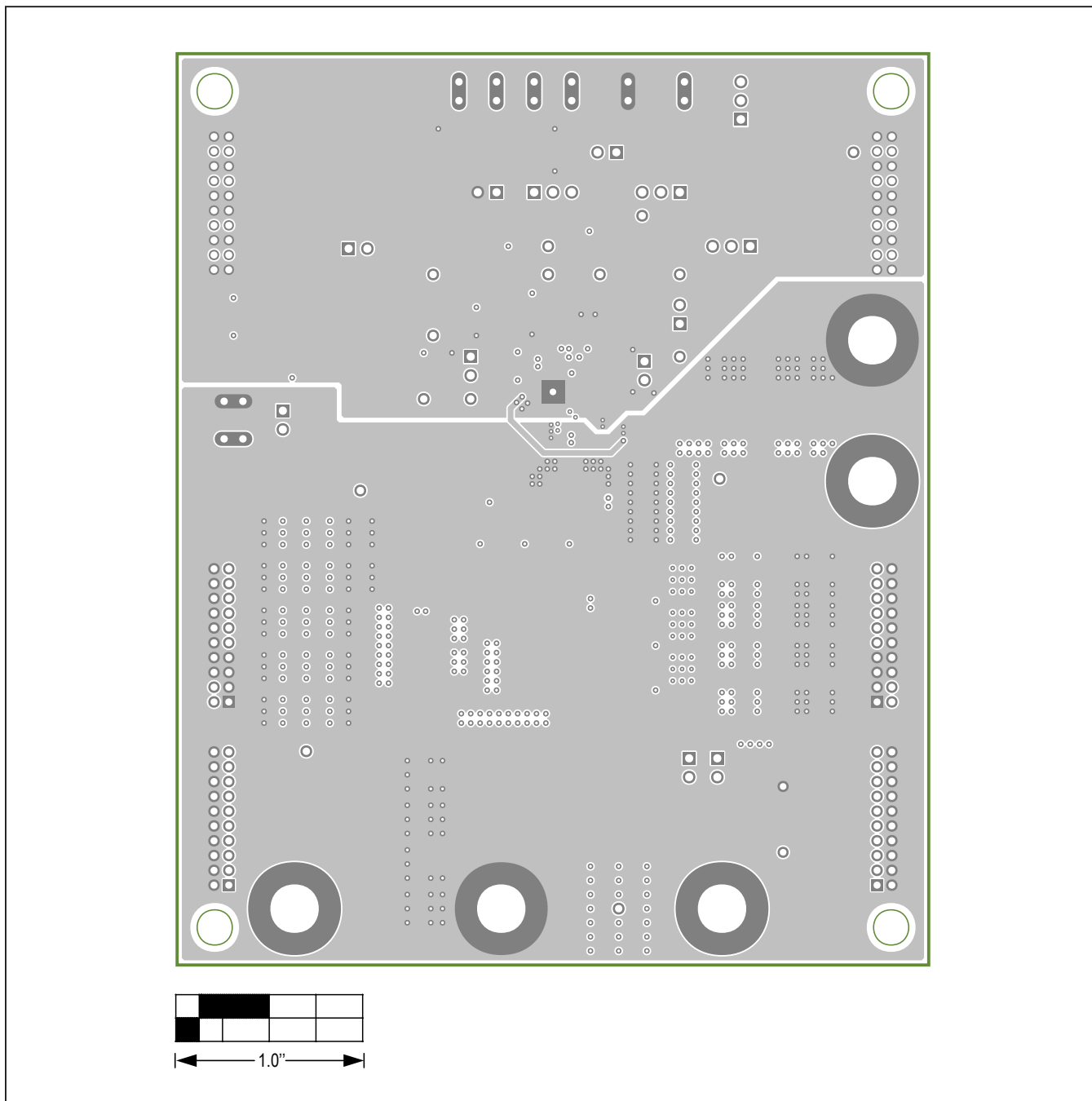

MAX15157B EV Kit PCB Layout—Internal Layer 2

MAX15157B EV Kit PCB Layout Diagrams (continued)

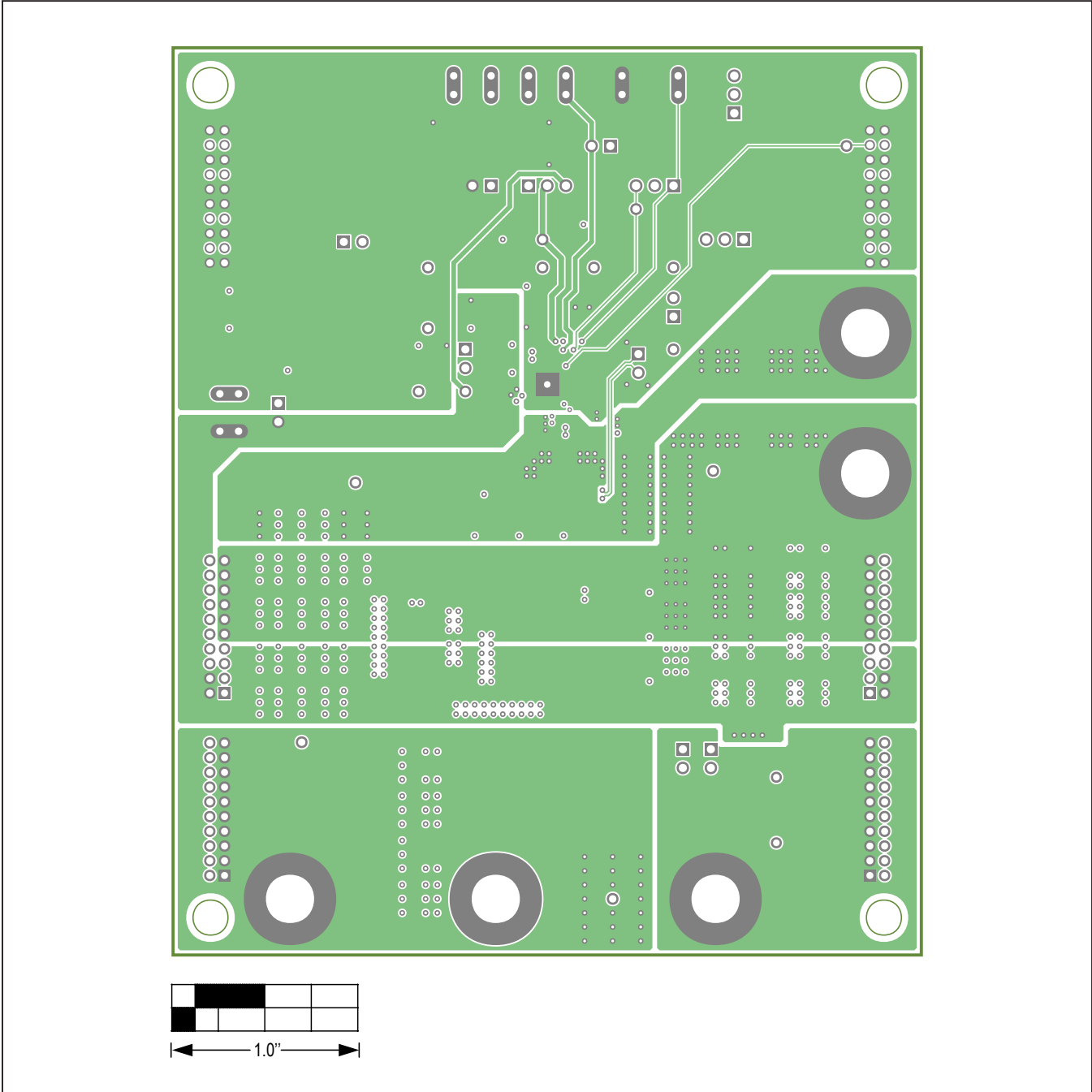

MAX15157B EV Kit PCB Layout—Internal Layer 3

MAX15157B EV Kit PCB Layout Diagrams (continued)

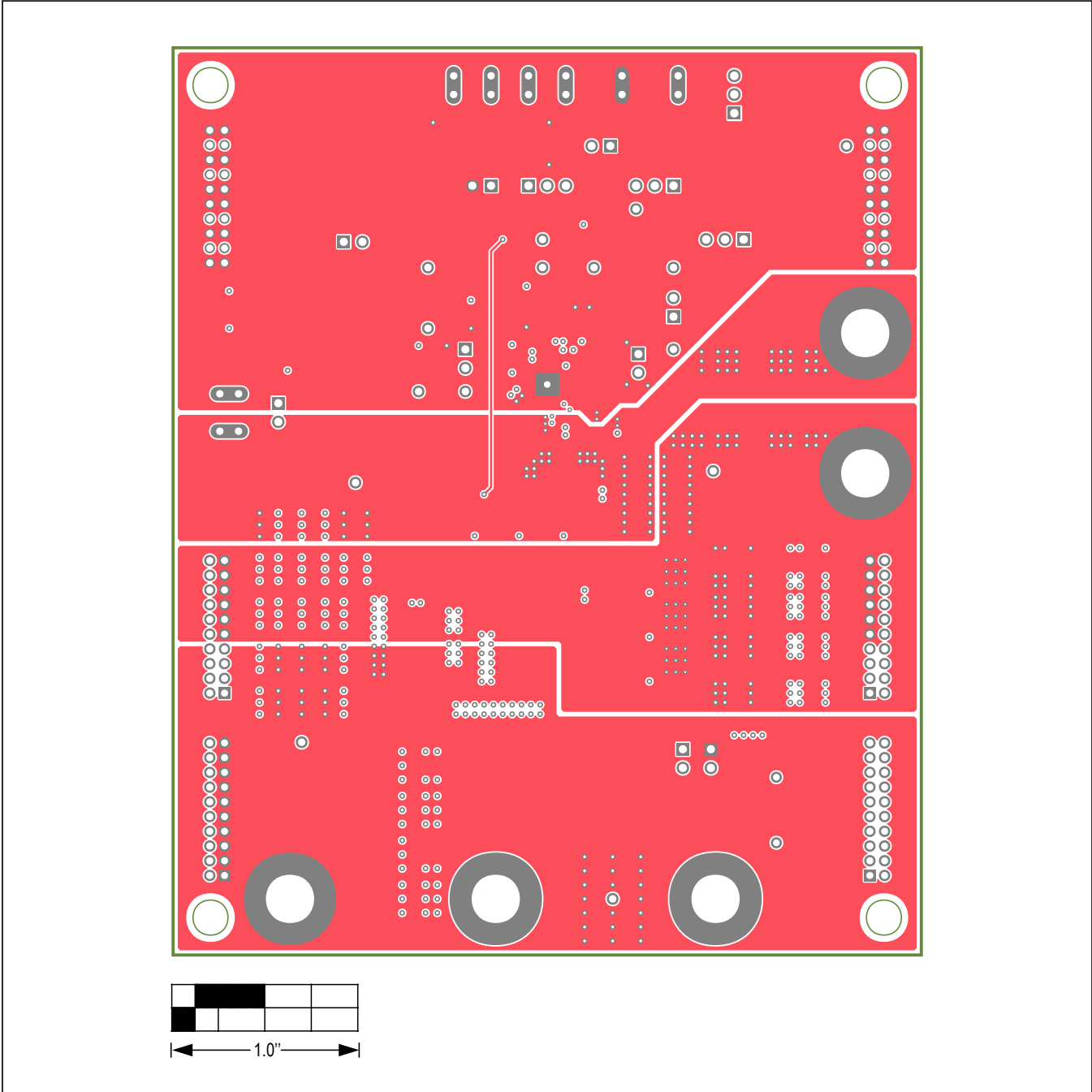

MAX15157B EV Kit PCB Layout—Internal Layer 4

MAX15157B EV Kit PCB Layout Diagrams (continued)

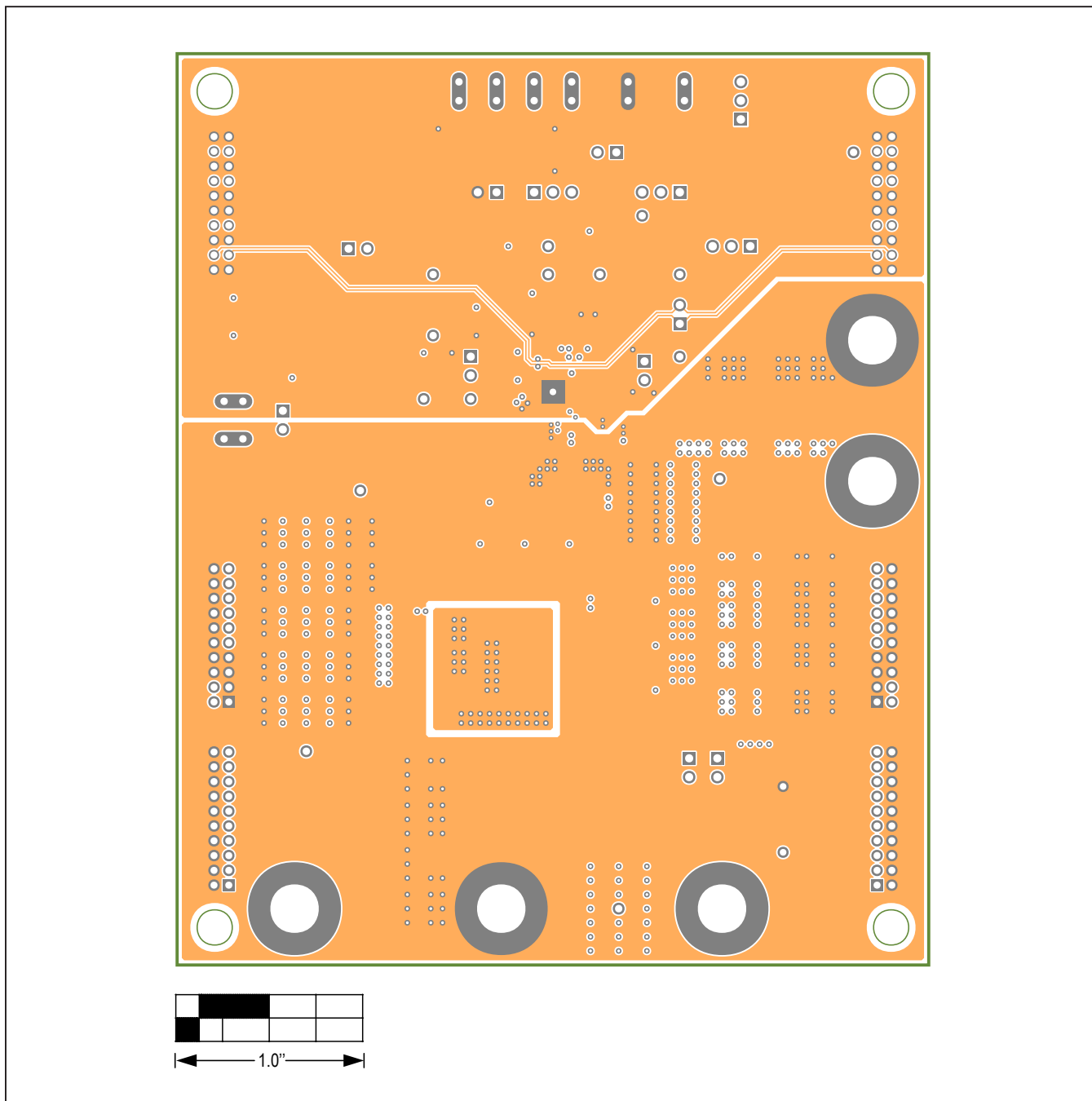

MAX15157B EV Kit PCB Layout—Internal Layer 5

MAX15157B EV Kit PCB Layout Diagrams (continued)

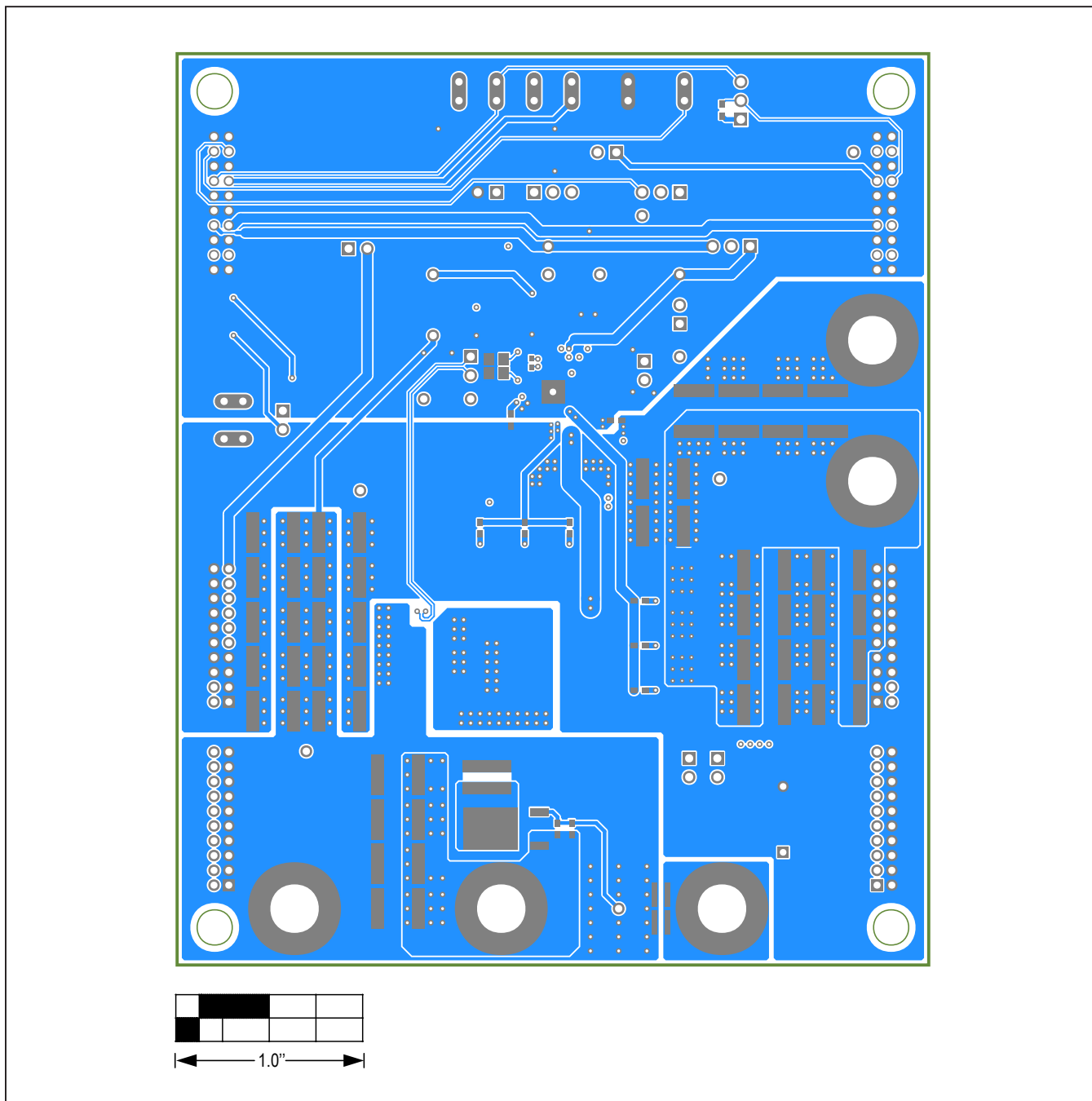

MAX15157B EV Kit PCB Layout Bottom Side



## Revision History

REVISION NUMBER	REVISION DATE	DESCRIPTION	PAGES CHANGED
0	12/17	Initial release	—
1	2/18	Updated Bill of Materials	4
2	11/19	Replaced <i>Bill of Materials, Schematic, and PCB Layout Diagrams</i>	4–15

For pricing, delivery, and ordering information, please visit Maxim Integrated's online storefront at <https://www.maximintegrated.com/en/storefront/storefront.html>.

*Maxim Integrated cannot assume responsibility for use of any circuitry other than circuitry entirely embodied in a Maxim Integrated product. No circuit patent licenses are implied. Maxim Integrated reserves the right to change the circuitry and specifications without notice at any time.*



## X-ON Electronics

Largest Supplier of Electrical and Electronic Components

*Click to view similar products for [Power Management IC Development Tools](#) category:*

*Click to view products by [Maxim](#) manufacturer:*

Other Similar products are found below :

[EVB-EP5348UI](#) [MIC23451-AAAYFL EV](#) [MIC5281YMME EV](#) [124352-HMC860LP3E](#) [DA9063-EVAL](#) [ADP122-3.3-EVALZ](#) [ADP130-0.8-EVALZ](#) [ADP130-1.8-EVALZ](#) [ADP1740-1.5-EVALZ](#) [ADP1870-0.3-EVALZ](#) [ADP1874-0.3-EVALZ](#) [ADP199CB-EVALZ](#) [ADP2102-1.25-EVALZ](#) [ADP2102-1.875EVALZ](#) [ADP2102-1.8-EVALZ](#) [ADP2102-2-EVALZ](#) [ADP2102-3-EVALZ](#) [ADP2102-4-EVALZ](#) [AS3606-DB](#) [BQ25010EVM](#) [BQ3055EVM](#) [ISLUSBI2CKIT1Z](#) [LP38512TS-1.8EV](#) [EVAL-ADM1186-1MBZ](#) [EVAL-ADM1186-2MBZ](#) [ADP122UJZ-REDYKIT](#) [ADP166Z-REDYKIT](#) [ADP170-1.8-EVALZ](#) [ADP171-EVALZ](#) [ADP1853-EVALZ](#) [ADP1873-0.3-EVALZ](#) [ADP198CP-EVALZ](#) [ADP2102-1.0-EVALZ](#) [ADP2102-1-EVALZ](#) [ADP2107-1.8-EVALZ](#) [ADP5020CP-EVALZ](#) [CC-ACC-DBMX-51](#) [ATPL230A-EK](#) [MIC23250-S4YMT EV](#) [MIC26603YJL EV](#) [MIC33050-SYHL EV](#) [TPS60100EVM-131](#) [TPS65010EVM-230](#) [TPS71933-28EVM-213](#) [TPS72728YFFEVM-407](#) [TPS79318YEQEVM](#) [UCC28810EVM-002](#) [XILINXPWR-083](#) [LMR22007YMINI-EVM](#) [LP38501ATJ-EV](#)