

## MAX15158/MAX15158A/ MAX15158Z Evaluation Kits

Evaluate: MAX15158  
MAX15158A  
MAX15158Z

### General Description

The MAX15158, MAX15158A, and MAX15158Z evaluation kits (EV kits) provide proven designs to evaluate the MAX15158, MAX15158A, and MAX15158Z, high-voltage multiphase boost controllers designed to support up to two MOSFET drivers and four external MOSFETs in single-phase or dual-phase inverting-buck-boost configurations. These EV kits operate from a -8V to -60V input voltage range and supports output voltage range of 3.3V to 60V. These EV kits use the MAX15158, MAX15158A, and MAX15158Z on a proven six-layer PCB design. Two pieces of MAX15013 are used as the MOSFET driver for the EV kits. These EV kits also feature an on-board buck converter (MAX17552) to provide 10V supply voltage to MAX15158/MAX15158A/MAX15158Z and the MOSFET driver.

### Features

- -8V to -60V Input Voltage Range for Inverting Buck-Boost Configuration
- 3.3V to 60V Output Voltage Range on Top of Input Voltage
- -40°C to 125°C Temperature Range
- Banana Jacks for Input and Output Voltage
- Configurable Output Voltage and Compensation Parameters
- Adjustable Current Limit
- Fully Assembled and Tested

**Ordering Information** appears at end of data sheet.

### Quick Start

#### Required Equipment

- MAX15158/MAX15158A/MAX15158Z EV kit assemblies
- One 60V DC power supply (PS1)
- Voltmeters

#### Procedure

These EV kits are fully assembled and tested. Follow the steps below to verify board operation.

**Caution: Do not turn on the power supply until all connections are completed.**

- 1) Verify that a shunt is installed across jumpers J3 and J4.
- 2) Verify that a shunt is installed between pins 2 and 3 on jumper J6.
- 3) Turn on power-supply PS1 and set the supply to 48V, then disable the power supply.
- 4) Connect the positive terminal of power-supply PS1 to the VIN+ banana jack on the EV kit. Connect the negative terminal of the power supply to the VIN- banana jack.
- 5) Enable the power supply.
- 6) Verify that the voltage between the VOUT\_P and VOUT\_N test points is 35V.
- 7) The EV kit is now ready for additional evaluation.

## Detailed Description of Hardware

The MAX15158/MAX15158A/MAX15158Z EV kits provide proven designs to evaluate the MAX15158, MAX15158A, and MAX15158Z fully integrated, highly efficient, two-phase switching regulators. These EV kits can be easily connected between power input and the load using the banana jacks and connectors provided for the input and output. Test points and connectors are provided to monitor and control the device signals. These EV kits operate between -8V and -60V input voltages. These EV kits regulate the output voltage between 3.3V and 60V. The output voltage is set to 35V by default on the EV kits. The output voltage can be changed by changing resistor divider between VOUT+ pin and OUTP pin. Make sure that the correct compensation is selected for stable operation.

### EN/UVLO Input for the MAX15158/MAX15158A/MAX15158Z

The devices' enable input (EN/UVLO) is controlled by resistor divider ratio between R19 and R20. The divider ratio is chosen so that the VIN UVLO threshold is set at 21V by default. If EN/UVLO pin voltage is above 1V, MAX15158/MAX15158A/MAX15158Z will power up. EN/UVLO pin can be connected to VIN- to disable the regulation. Additionally, a test point (EN) is also provided to drive the EN/UVLO pin. While changing the UVLO threshold, make sure that the UVLO threshold of MAX15158/MAX15158A/MAX15158Z is higher than the UVLO threshold of the onboard DRV supply MAX17552 (U4).

### DRV Supply Selection

The MAX15158, MAX15158A, MAX15158Z, and MAX15013 requires a secondary 8V–12V power supply (DRV) for the LDO and gate drive. The supply for DRV pin can be selected from onboard supply by installing shuts across jumpers J3 and J4. Alternatively, an external power supply can be used by applying and 8V–12V between test points VDRV and PGND.

**Table 1. J3 and J4 Jumper Selection**

JUMPER CONNECTIONS	VLDOIN VOLTAGE
J3 installed and J4 installed*	Onboard Power supply
J3 not installed and J4 not installed	External Power Supply

\*Default position

### Bode Plot

10Ω resistor is installed between VOUT\_P sense point and OUTP pin to measure bode plot. BODE+ and BODE- test points are provided on the board on either side of 10Ω resistor for small-signal injection and ability to measure bode plot.

### Output Regulation

VOUT\_P and VOUT\_N test points are provided to measure the VOUT regulation.

### Efficiency Measurement

V<sub>IN\_P</sub> and V<sub>IN\_N</sub> are provided to measure V<sub>IN</sub> during efficiency measurement. Also, V<sub>OUT\_P</sub> and V<sub>OUT\_N</sub> are provided to measure V<sub>OUT</sub> during efficiency measurement.

### FREQ/CLK Pin

Switching frequency is selected by connecting R16 resistor between FREQ/CLK pin and VIN-. The switching frequency can also be selected by providing a 480kHz to 4MHz external clock at this pin. A test point (CLOCK) is also provided to drive this pin.

### REFIN Pin (MAX15158/MAX15158Z)

By default, REFIN pin is connected to BIAS supply through R9 (0Ω resistor). R9 can be removed and REFIN can be connected to external supply (between 1V to 2.2V) to change the VOUT reference and therefore change output regulation voltage. The external supply should be applied between test point REFIN and AGND.

### Connecting Multiple EV Kits Together

The EV kit provides jumpers J1, J2, J8, J9, J10, and J11 to connect two EV kits together for four-phase operation. Based on the MAX15158/MAX15158A and MAX15158Z data sheets, the EV kits can be configured for master and slave operation.

## Ordering Information

PART	TYPE	DESCRIPTION
MAX15158EVKIT#	EV kit	Standard version
MAX15158AEVKIT#	EV kit	No REFIN version
MAX15158ZEVKIT#	EV kit	No "soft-stop" version

# Denotes RoHS Compliant

MAX15158/MAX15158A/  
MAX15158Z Evaluation Kits

Evaluate: MAX15158  
MAX15158A  
MAX15158Z

MAX15158/MAX15158A/MAX15158Z EV Kit Bill of Materials

ITEM	REF_DES	DNI/DNP	QTY	MFG PART #	MANUFACTURER	VALUE	DESCRIPTION
1	3P3, 3P3_GND, AGND, CLOCK, PGND, VDRV	—	6	9020 BUSS	WEICO WIRE	MAXIMPAD	EVK KIT PARTS; MAXIM PAD; WIRE; NATURAL; SOLID; WEICO WIRE; SOFT DRAWN BUS TYPE-S; 20AWG
2	BODE+, BODE-, COMP_EN, FB, PGOOD, REFIN, SS, V4V6, VIN_N, VIN_P, VOUT_N, VOUT_P	—	13	5011	KEYSTONE	N/A	TEST POINT; PIN DIA = 0.125IN; TOTAL LENGTH = 0.445IN; BOARD HOLE = 0.063IN; BLACK; PHOSPHOR BRONZE WIRE SILVER PLATE FINISH;
3	C1, C44	—	2	EEV-FK2A680Q	PANASONIC	68UF	CAPACITOR; SMT (CASE_H13); ALUMINUM-ELECTROLYTIC; 68UF; 100V; TOL = 20%; MODEL = EEV SERIES
4	C2, C39, C45	—	3	GRM188R71E105KA12; CGA3E1X7R1E105K; TMK107B7105KA; 0603C105KAT2A; GCM188R71E105KA64	MURATA;TDK;TAIYO YUDEN; AVX;MURATA	1UF	CAPACITOR; SMT (0603); CERAMIC CHIP; 1UF; 25V; TOL = 10%; TG = -55°C TO +125°C; TC = X7R
5	C3, C6, C8-C12, C14, C18-C21, C23, C25, C28, C30, C31, C34, C37, C38, C41, C42, C46, C49, C51-C55, C59, C69, C72, C74, C76-C78, C83-C85, C93-C95	—	42	CGA6M3X7S2A475K200AE; CGA6M3X7S2A475K200AB	TDK;TDK	4.7UF	CAPACITOR; SMT (1210); CERAMIC CHIP; 4.7UF; 100V; TOL = 10%; TG = -55°C TO +125°C; TC = X7S; AUTO
6	C4, C13, C24, C47, C58, C73	—	6	CC0603KRX7R0BB104; GRM188R72A104KA35; GCJ188R72A104KA01	YAGEO;MURATA; MURATA	0.1UF	CAPACITOR; SMT (0603); CERAMIC CHIP; 0.1UF; 100V; TOL = 10%; TG = -55°C TO +125°C; TC = X7R
7	C5, C7	—	2	C0603C101J2GAC	KEMET	100PF	CAPACITOR; SMT (0603); CERAMIC CHIP; 100PF; 200V; TOL = 5%; TG = -55°C TO +125°C; TC = C0G
8	C16, C17, C26, C27, C48, C50	—	6	GRM155S1E102JA01D; C1005C0G1E102J050BA	MURATA;TDK	1000PF	CAPACITOR; SMT (0402); CERAMIC CHIP; 1000PF; 25V; TOL = 5%; TG = -55°C TO +125°C; TC = C0G
9	C22	—	1	GRM32ER71J106KA12	MURATA	10UF	CAPACITOR; SMT (1210); CERAMIC CHIP; 10UF; 63V; TOL = 10%; TG = -55°C TO +125°C; TC = X7R
10	C29	—	1	C1005X5R1E474K050	TDK	0.47UF	CAPACITOR; SMT (0402); CERAMIC CHIP; 0.47UF; 25V; TOL = 10%; TG = -55°C TO +85°C; TC = X5R;
11	C32	—	1	C0402C103K5RAC; GRM155R71H103KA88; C1005X7R1H103K050BE	KEMET;MURATA;TDK	0.01UF	CAPACITOR; SMT (0402); CERAMIC CHIP; 0.01UF; 50V; TOL = 10%; TG = -55°C TO +125°C; TC = X7R
12	C33	—	1	C1005X7R1E473K; GRM155R71E473K	TDK;MURATA	0.047UF	CAPACITOR; SMT (0402); CERAMIC CHIP; 0.047UF; 25V; TOL = 10%; TG = -55°C TO +125°C
13	C35	—	1	GRM155R71H683KE14	MURATA	0.068UF	CAPACITOR; SMT (0402); CERAMIC CHIP; 0.068UF; 50V; TOL = 10%; TG = -55°C TO +125°C; TC = X7R
14	C36	—	1	C0402C101K5GAC; C1005C0G1H101K050BA	KEMET;TDK	100PF	CAPACITOR; SMT; 0402; CERAMIC; 100PF; 50V; 10%; C0G; -55°C to +125°C; 0 ±30PPM/°C
15	C40	—	1	GRM188C71E225KE11	MURATA	2.2UF	CAPACITOR; SMT (0603); CERAMIC CHIP; 2.2UF; 25V; TOL = 10%; TG = -55°C TO +125°C; TC = X7S
16	C43, C89	—	2	AFK227M63H32T; EEV-FK1J221Q	CORNELL DUBILIER; PANASONIC	220UF	CAPACITOR; SMT (CASE_H13); ALUMINUM-ELECTROLYTIC; 220UF; 63V; TOL = 20%; TG = -55°C TO +105°C
17	C56	—	1	EEE-FK2A220P	PANASONIC	22UF	CAPACITOR; SMT (CASE_F); ALUMINUM-ELECTROLYTIC; 22UF; 100V; TOL = 20%; MODEL = EEV SERIES; TG = -55°C TO +105°C
18	C57	—	1	GRM31CR72A105KA01L; C3216X7R2A105K160	MURATA;TDK	1UF	CAPACITOR; SMT; 1206; CERAMIC; 1uF; 100V; 10%; X7R; -55°C to +125°C
19	C61, C64	—	2	GRM219R6YA475KA73	MURATA	4.7UF	CAPACITOR; SMT (0805); CERAMIC CHIP; 4.7UF; 35V; TOL = 10%; TG = -55°C TO +85°C; TC = X5R
20	C90	—	1	C1210C475K1R2C; GRM32ER72A475KE14	KEMET;MURATA	4.7UF	CAPACITOR; SMT (1210); CERAMIC CHIP; 4.7UF; 100V; TOL = 10%; MODEL = ; TG = -55°C TO +125°C; TC = X7R
21	D1-D4	—	4	BAV16WS-7-F	DIODES INCORPORATED	BAV16WS	DIODE; SWT; SMT (SOD-323); PIV = 75V; IF = 0.3A
22	D5	—	1	SMAJ64A	LITTELFUSE	64V	DIODE; TVS; SMA (DO-214AC); PIV = 64V; IF = 3.9A
23	J1, J8, J10	—	3	LS2-110-01-S-D-RA1	SAMTEC	LS2-110-01-S-D-RA1	CONNECTOR; THROUGH HOLE; SELF MATING HERMAPHRODITIC STRIP SHROUD DOWN; RIGHT ANGLE; 20PINS
24	J2, J9, J11	—	3	LS2-110-01-S-D-RA2	SAMTEC	LS2-110-01-S-D-RA2	CONNECTOR; THROUGH HOLE; SELF MATING HERMAPHRODITIC STRIP SHROUD UP; RIGHT ANGLE; 20PINS
25	J3-J5, J7, J12	—	5	PEC02SAAN	SULLINS	PEC02SAAN	CONNECTOR; MALE; THROUGH HOLE; BREAKAWAY; STRAIGHT; 2PINS
26	J6	—	1	PBC03SAAN	SULLINS	PBC03SAAN	CONNECTOR; MALE; THROUGH HOLE; BREAKAWAY; STRAIGHT; 3PINS; -65°C TO +125°C
27	L1, L2	—	2	SER2915H-103KL	COILCRAFT	10UH	INDUCTOR; SMT; FERRITE; 10UH; 10%; 30A
28	L3	—	1	LPS5030-154MR	COILCRAFT	150UH	INDUCTOR; SMT; SHIELDED; 150UH; TOL = ±20%; 0.57A
29	MH1-MH4	—	4	91772A108; PHILLIPS-PAN_4-40X3/8IN; PMSS4400038PH; 9901	GENERIC PART	N/A	MACHINE SCREW; PHILLIPS; PAN; 4-40; 3/8IN; 18-8 STAINLESS STEEL
30	MH1-MH4	—	4	MCH_SO_F_HEX_4-40X1/2	GENERIC PART	N/A	STANDOFF; FEMALE-THREADED; HEX; 4-40; 1/2IN; ALUMINUM
31	Q1, Q2, Q5, Q6	—	4	BSC110N15NS5	INFINEON	BSC110N15NS5	TRAN; NCH; PG-TDSON8; PD-(125W); I-(76A); V-(150V)
32	R1, R2, R28, R29	—	4	CRCW0402221RFK	VISHAY DALE	221	RESISTOR; 0402; 221Ω; 1%; 100PPM; 0.0625W; THICK FILM
33	R3, R4, R33, R34	—	4	CRCW0402000Z0EDHP; RCS0402000Z0	VISHAY DRALORIC; VISHAY DALE	0	RESISTOR; 0402; 0Ω; 0%; JUMPER; 0.2W; THICK FILM
34	R6, R7, R36, R37	—	4	CRCW040210R0FK; 9C04021A10R0FL	VISHAY DALE;YAGEO	10	RESISTOR; 0402; 10Ω; 1%; 100PPM; 0.0625W; THICK FILM
35	R8	—	1	CRCW0402100KFK; RCD402FR-07100KL	VISHAY DALE; YAGEO PHICOMP	100K	RESISTOR; 0402; 100K; 1%; 100PPM; 0.0625W; THICK FILM
36	R9, R23, R57-R59, R61-R63, R65	—	9	ERJ-2GE0R00X	PANASONIC	0	RESISTOR; 0402; 0Ω; 0%; JUMPER; 0.10W; THICK FILM

MAX15158/MAX15158A/  
MAX15158Z Evaluation Kits

Evaluate: MAX15158  
MAX15158A  
MAX15158Z

MAX15158/MAX15158A/MAX15158Z EV Kit Bill of Materials (continued)

ITEM	REF_DES	DNI/DNP	QTY	MFG PART #	MANUFACTURER	VALUE	DESCRIPTION
37	R14, R39	—	2	WSL20103L000F	VISHAY DALE	0.003	RESISTOR; 2010; 0.003Q; 1%; 150PPM; 0.5W; THICK FILM
38	R15	—	1	CRCW0603267KFK	VISHAY DALE	267K	RESISTOR; 0603; 267KQ; 1%; 100PPM; 0.1W; THICK FILM
39	R16	—	1	CRCW040241K2FK	VISHAY DALE	41.2K	RESISTOR; 0402; 41.2KQ; 1%; 100PPM; 0.063W; THICK FILM
40	R17	—	1	CRCW040249K9FK; 9C04021A4992FLHF3	VISHAY DALE; YAGEO	49.9K	RESISTOR; 0402; 49.9K; 1%; 100PPM; 0.0625W; THICK FILM
41	R18	—	1	CRCW0402332ZFK	VISHAY DALE	33.2K	RESISTOR; 0402; 33.2K; 1%; 100PPM; 0.0625W; THICK FILM
42	R19	—	1	ERJ-2RKF6193	PANASONIC	619K	RES; SMT (0402); 619K; 1%; ±100PPM/DEGC; 0.1W
43	R20	—	1	CRCW04023012FK; CRCW040230K1FK	VISHAY DALE; VISHAY DALE	30.1K	RESISTOR; 0402; 30.1K; 1%; 100PPM; 0.0625W; THICK FILM
44	R21	—	1	ERJ-2RKF3922X	PANASONIC	39.2K	RESISTOR; 0402; 39.2KQ; 1%; 100PPM; 0.10W; METAL FILM
45	R22	—	1	CRCW04026K20FK	VISHAY DALE	6.2K	RESISTOR; 0402; 6.2KQ; 1%; 100PPM; 0.063W; THICK FILM
46	R24	—	1	CRCW04022K00FK; RK73H1ETTP2001F	VISHAY DALE; KOA SPEER	2K	RESISTOR; 0402; 2K; 1%; 100PPM; 0.0625W; THICK FILM
47	R25	—	1	CRCW0402200RFK	VISHAY DALE	200	RESISTOR; 0402; 200Q; 1%; 100PPM; 0.063W; THICK FILM
48	R26, R60	—	2	CRCW06030000ZS; MCR03EZFJ000; ERJ-3GEY0R00	VISHAY DALE;ROHM; PANASONIC	0	RESISTOR; 0603; 0Q; 0%; JUMPER; 0.10W; THICK FILM
49	R27, R51, R52	—	3	CRCW060310R0FK; MCR03EZFPI0R0	VISHAY DALE;ROHM	10	RESISTOR; 0603; 10Q; 1%; 100PPM; 0.10W; THICK FILM
50	R30	—	1	CR0402-16W-3013FT; CRCW0402301KFK	VENKEL LTD.; VISHAY DALE	301K	RESISTOR; 0402; 301KQ; 1%; 100PPM; 0.063W; THICK FILM
51	R31	—	1	CRCW0402110KFK	VISHAY DALE	110K	RESISTOR; 0402; 110KQ; 1%; 100PPM; 0.063W; THICK FILM
52	R32	—	1	CRCW0402249KFK	VISHAY DALE	249K	RESISTOR; 0402; 249KQ; 1%; 100PPM; 0.063W; THICK FILM
53	R35	—	1	CRCW04023M01FK	VISHAY DALE	3.01M	RESISTOR; 0402; 3.01MQ; 1%; 100PPM; 0.063W; METAL FILM
54	R38	—	1	CRCW04022K1FK	VISHAY DALE	22.1K	RESISTOR; 0402; 22.1KQ; 1%; 0.063W; THICK FILM
55	R40	—	1	CRCW040234K8FK	VISHAY DALE	34.8K	RESISTOR; 0402; 34.8KQ; 1%; 100PPM; 0.063W; THICK FILM
56	R42	—	1	CRCW06031K50FK	VISHAY DALE	1.5K	RESISTOR; 0603; 1.5K; 1%; 100PPM; 0.10W; THICK FILM
57	R43	—	1	CRCW06033K90FK	VISHAY DALE	3.9K	RESISTOR; 0603; 3.9KQ; 1%; 100PPM; 0.10W; THICK FILM
58	R44	—	1	3223W-1-104	BOURNS	100K	RESISTOR; SMT J-LEAD; TRIMMING POTENTIOMETER; 11 TURNS; 100KQ; 20%; 100PPM; 0.125W; TADJ
59	R45	—	1	ERJ-3EKF5902	PANASONIC	59K	RESISTOR; 0603; 59KQ; 1%; 100PPM; 0.1W; THICK FILM
60	R46	—	1	CRCW0603100KFK; RC0603FR-07100KL; RC0603FR-13100KL; ERJ-3EKF1003; AC0603FR-07100KL	VISHAY;YAGEO;YAGEO; PANASONIC;YAGEO	100K	RESISTOR; 0603; 100K; 1%; 100PPM; 0.10W; THICK FILM
61	R47-R50	—	4	CRCW04022R0FK	VISHAY DALE	2	RESISTOR; 0402; 2Q; 1%; 100PPM; 0.0625W; THICK FILM
62	R53, R55	—	2	CRCW04023K00FK	VISHAY DALE	3K	RESISTOR; 0402; 3KQ; 1%; 100PPM; 0.0625W; THICK FILM
63	R54, R56	—	2	CRCW04021K00FK; RC0402FR-071KL	VISHAY DALE; YAGEO PHICOMP	1K	RESISTOR; 0402; 1K; 1%; 100PPM; 0.0625W; THICK FILM
64	U1, U3	—	2	MAX15013CASA+	MAXIM	MAX15013CASA+	IC; DRV; 175V/2A; HIGH-SPEED; HALF-BRIDGE MOSFET DRIVER; NSOIC8-EP
65	U2	—	1	MAX15158ATJ+ MAX15158AATJ+ MAX15158ZATJ+	MAXIM	MAX15158ATJ+ MAX15158AATJ+ MAX15158ZATJ+	EVKIT -IC; MAX15158ATJ+/MAX15158AATJ+/MAX15158ZATJ+; PACKAGE OUTLINE: 21-0140; PACKAGE LAND PATTERN: 90-0603; PACKAGE CODE: T3255-6
66	U4	—	1	MAX17552AUB+	MAXIM	MAX17552AUB+	IC; CONV; 60V; 100MA; ULTRA-SMALL; HIGH EFFICIENCY; SYNCHRONOUS STEP-DOWN DC-DC CONVERTER WITH 22UA NO-LOAD SUPPLY CURRENT; UMAX10
67	U5	—	1	MAX17651AZT+	MAXIM	MAX17651AZT+	IC; REG; ULTRA-LOW QUIESCENT CURRENT; LINEAR REGULATOR; TSOT6
68	VIN+, VIN-, VOUT+, VOUT-	—	4	111-2223-001	EMERSON NETWORK POWER	111-2223-001	MACHINE SCREW; THUMBSCREW; BANANA; 1/4-32IN; 11/32IN; NICKEL PLATED BRASS
69	PCB	—	1	MAX15158ATJ+/MAX15158AATJ+/ MAX15158ZATJ+	MAXIM	PCB	PCB MAX15158Z
70	C15	DNP	0	C0402C102K5GAC	KEMET	1000PF	CAPACITOR; SMT (0402); CERAMIC CHIP; 1000PF; 50V; TOL = 10%; MODEL =; TG = -55°C TO +125°C; TC = C0G
71	C60	DNP	0	GRM155R71C224KA12	MURATA	0.22UF	CAPACITOR; SMT (0402); CERAMIC; 0.22UF; 16V; TOL = 10%; MODEL = GRM SERIES; TG = -55°C TO +125°C; TC = XTR
72	C62, C63, C67, C68	DNP	0	GRM155R72A221KA01	MURATA	220PF	CAPACITOR; SMT (0402); CERAMIC; 220PF; 100V; TOL = 10%; MODEL = GRM SERIES; TG = -55°C TO +125°C; TC = XTR
73	C65, C66	DNP	0	C0402C0G500-470JNE; CC0402JRNPO9BNA70; GRM1555C1H470JA01	VENKEL LTD.; YAGEO PHYCOMP;MURATA	47PF	CAPACITOR; SMT (0402); CERAMIC CHIP; 47PF; 50V; TOL = 5%; MODEL =; TG = -55°C TO +125°C; TC = C0G
74	C70, C71	DNP	0	CGA2B3X7R1H104K; C1005X7R1H104K050BB; GRM155R71H104KE14; GCM155R71H104KE02	TDK;TDK;MURATA;MURATA	0.1UF	CAPACITOR; SMT (0402); CERAMIC CHIP; 0.1UF; 50V; TOL = 10%; TG = -55°C TO +125°C; TC = XTR
75	C75, C79-C82, C86-C88, C91, C92, C96-C99	DNP	0	CGA6M3X7S2A475K200AE; CGA6M3X7S2A475K200AB	TDK;TDK	4.7UF	CAPACITOR; SMT (1210); CERAMIC CHIP; 4.7UF; 100V; TOL = 10%; TG = -55°C TO +125°C; TC = XTS; AUTO
76	Q3, Q4, Q7, Q8	DNP	0	BSC110N15NS5	INFINEON	BSC110N15NS5	TRAN; NCH; PG-TDSON8; PD-(125W); I(76A); V-(150V)
77	R5	DNP	0	CRCW0603100KFK; RC0603FR-07100KL; RC0603FR-13100KL; ERJ-3EKF1003; AC0603FR-07100KL	VISHAY;YAGEO;YAGEO; PANASONIC;YAGEO	100K	RESISTOR; 0603; 100K; 1%; 100PPM; 0.10W; THICK FILM
78	R10-R13, R64	DNP	0	ERJ-2GE0R00X	PANASONIC	0	RESISTOR; 0402; 0Q; 0%; JUMPER; 0.10W; THICK FILM
79	R66, R67	DNP	0	WSL20103L000F	VISHAY DALE	0.003	RESISTOR; 2010; 0.003Q; 1%; 150PPM; 0.5W; THICK FILM
	<b>TOTAL</b>		<b>194</b>				

# MAX15158/MAX15158A/ MAX15158Z Evaluation Kits

Evaluate: MAX15158  
MAX15158A  
MAX15158Z

## EV Kit Schematic

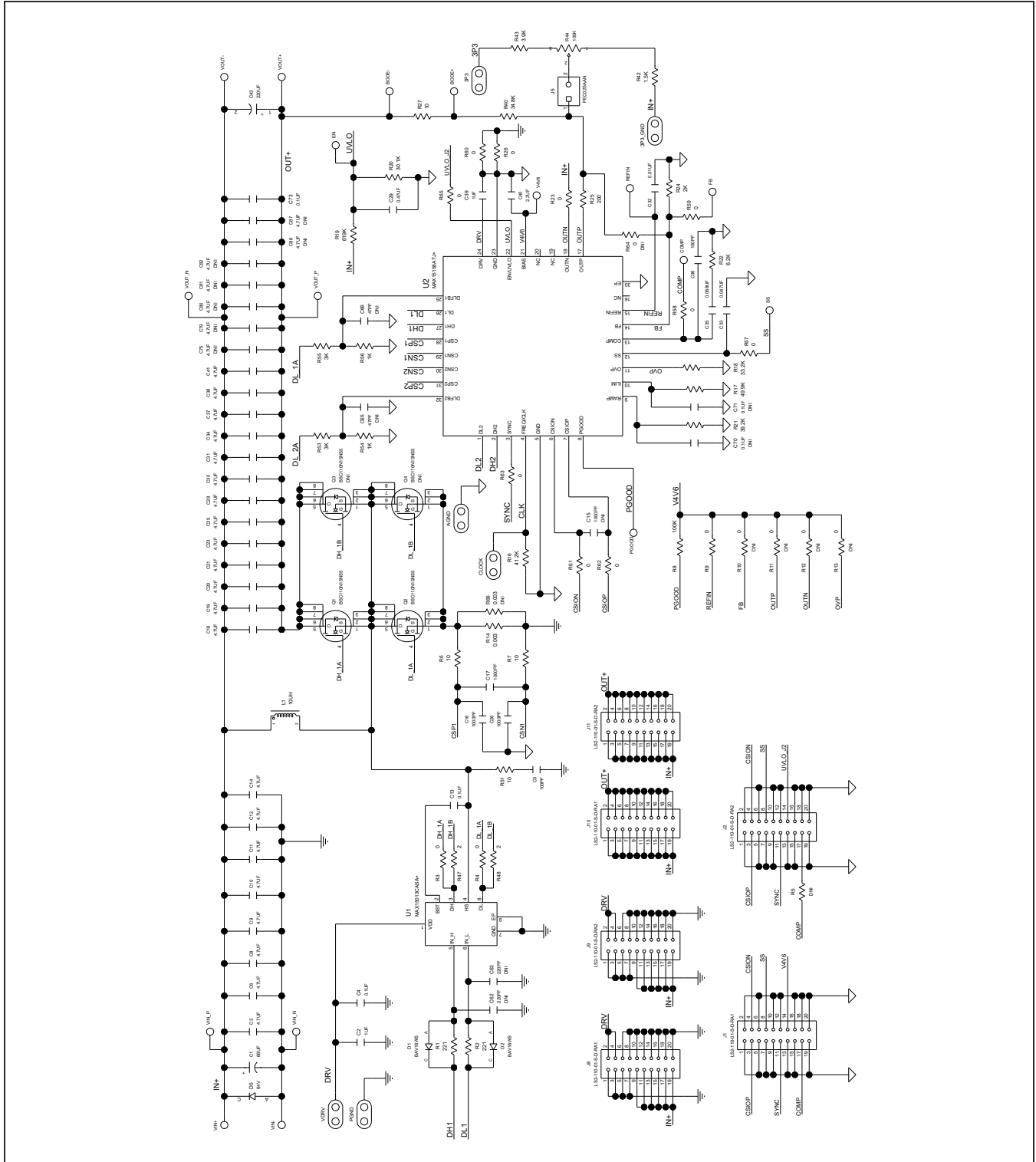

EV Kit Schematic (continued)

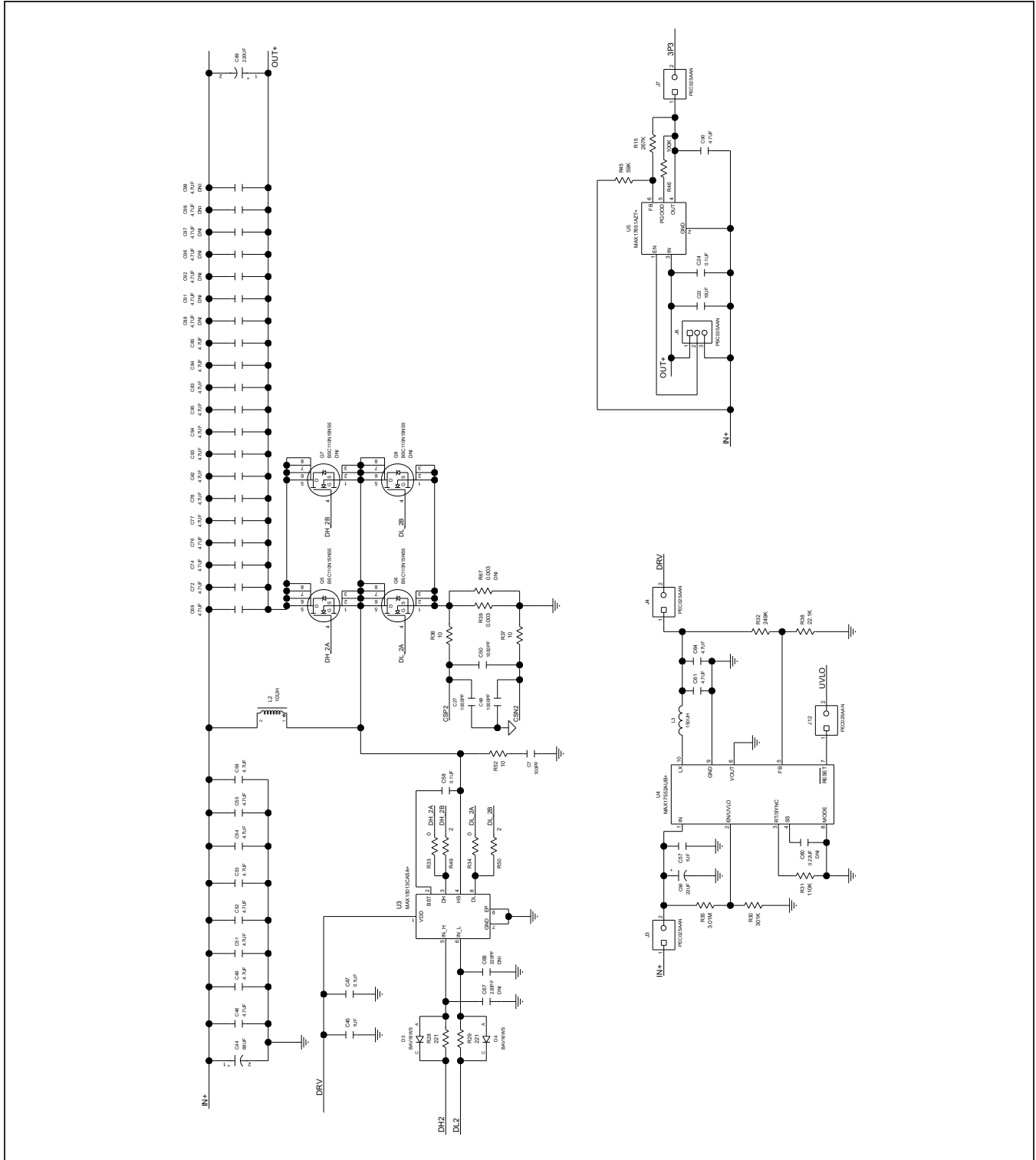

EV Kit PCB Layout Diagrams

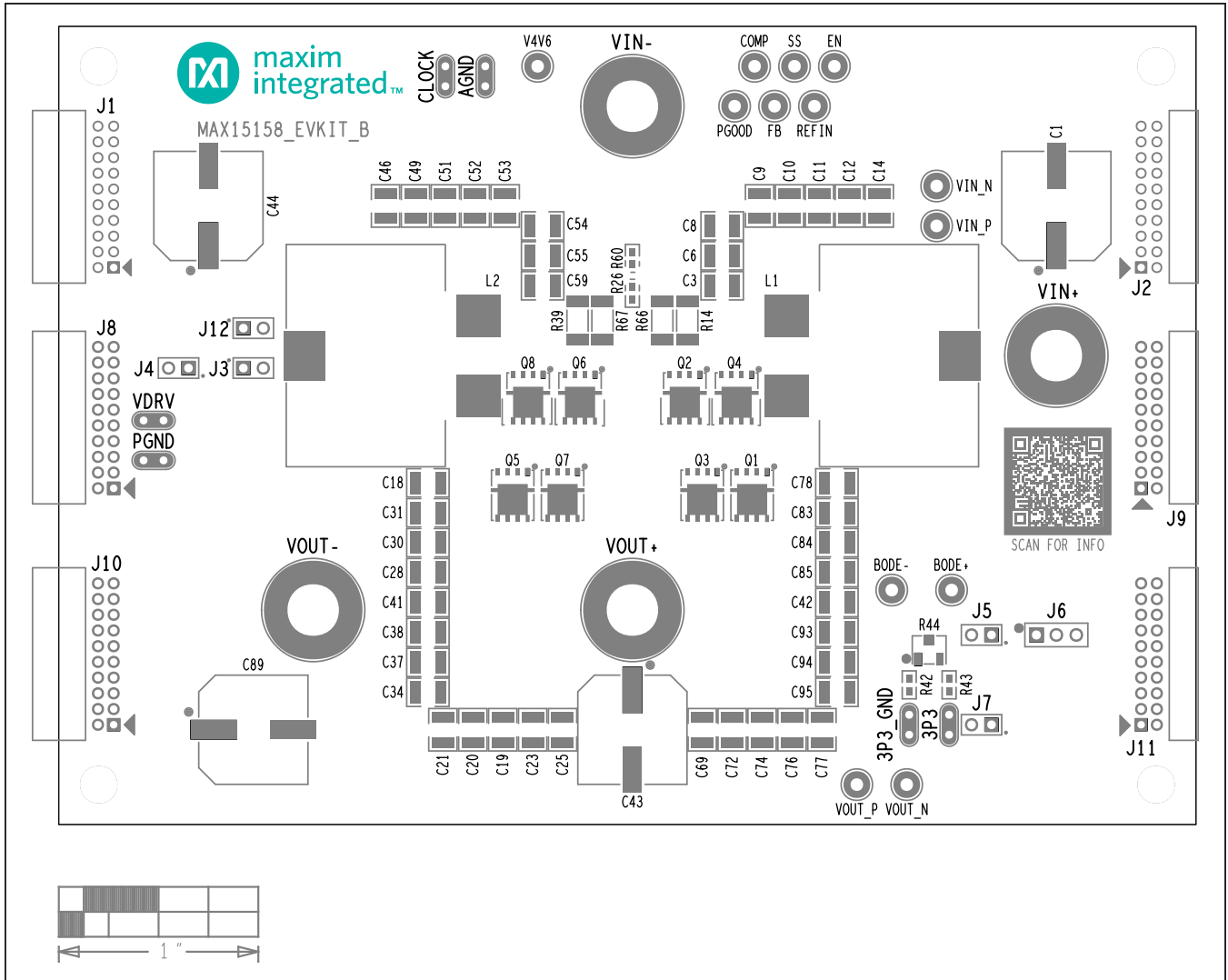

EV Kit Component Placement Guide—Top Silkscreen

EV Kit PCB Layout Diagrams (continued)

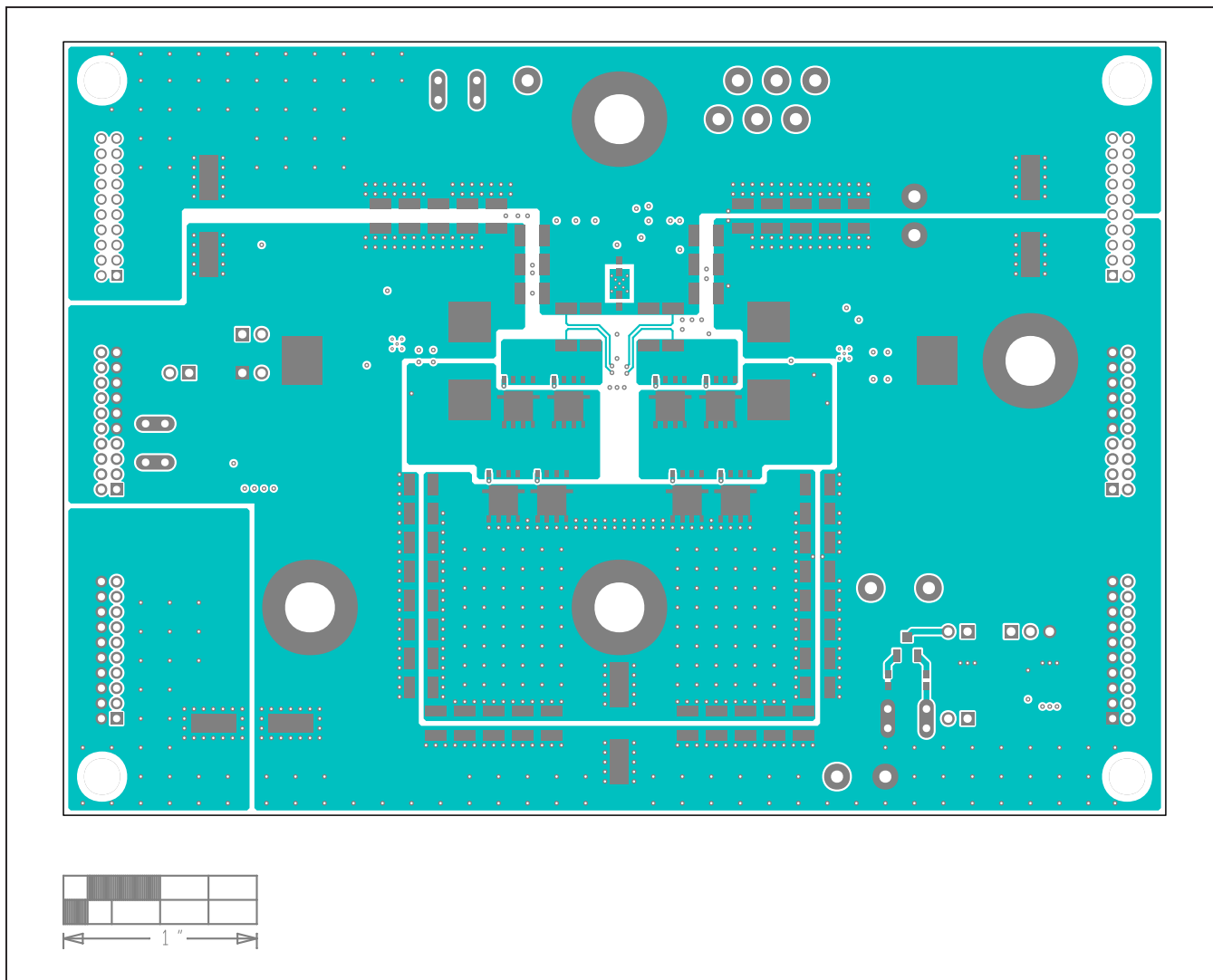

EV Kit PCB Layout—Top Layer



EV Kit PCB Layout Diagrams (continued)

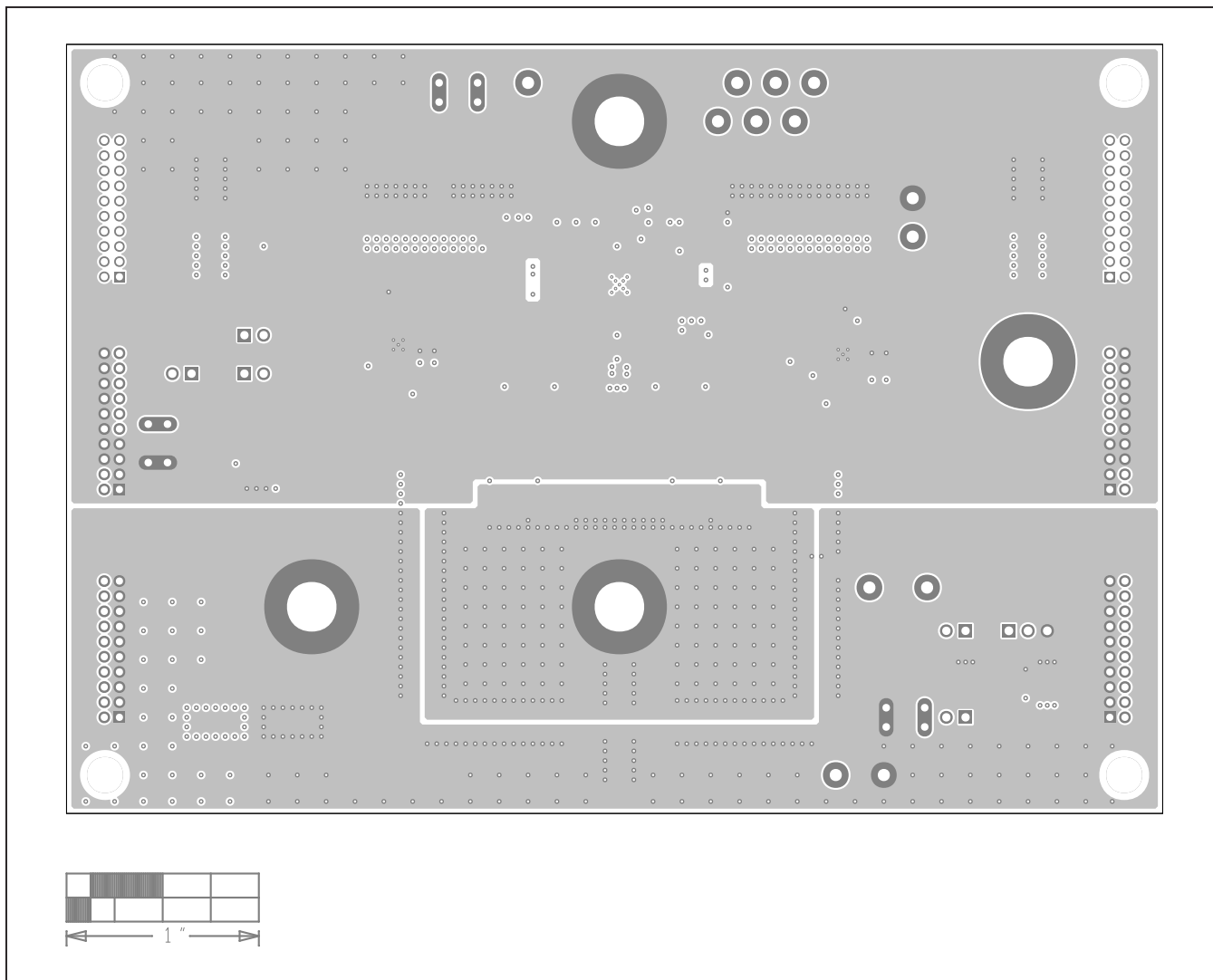

EV Kit PCB Layout—Internal Layer 2

EV Kit PCB Layout Diagrams (continued)

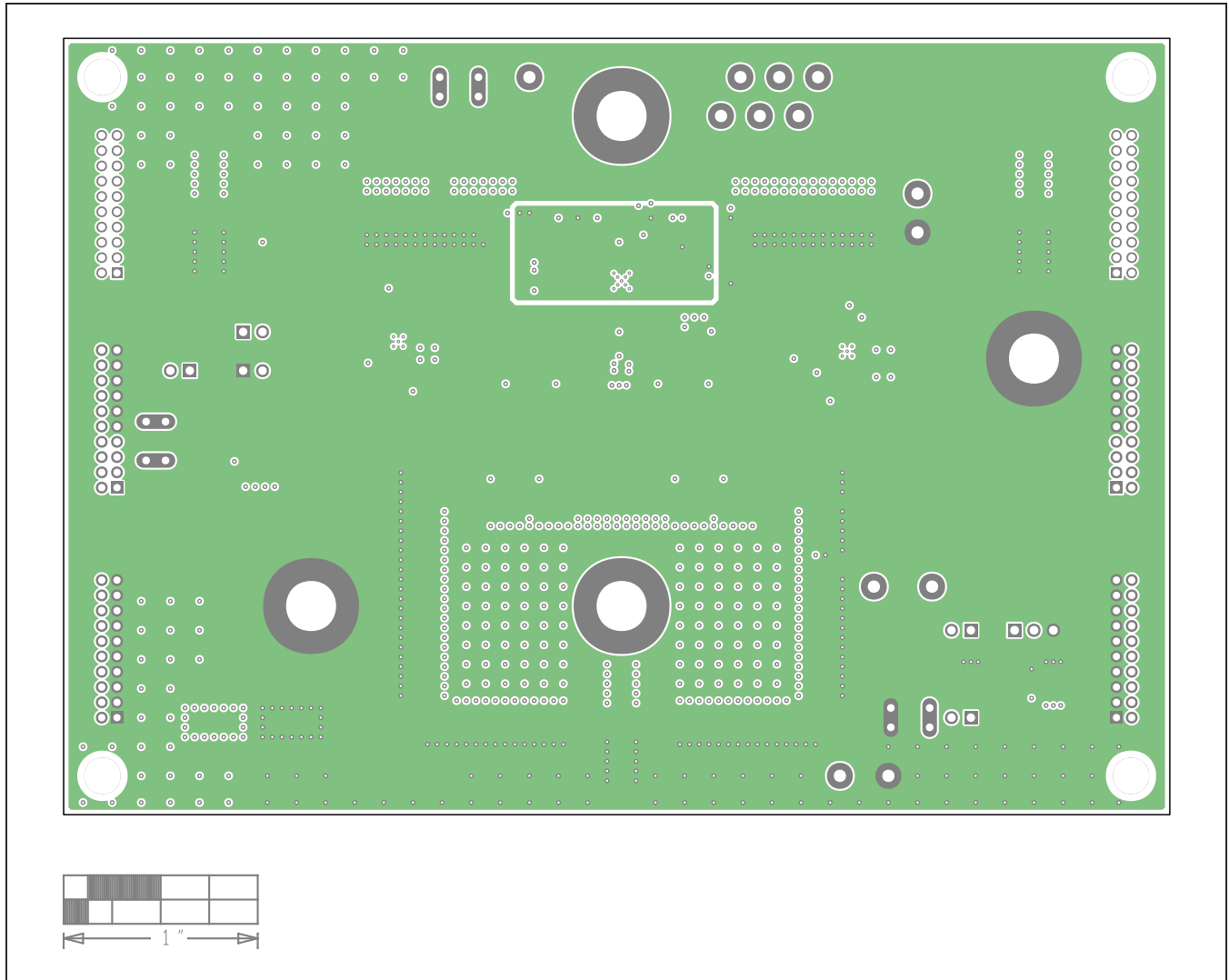

EV Kit PCB Layout—Internal Layer 3

EV Kit PCB Layout Diagrams (continued)

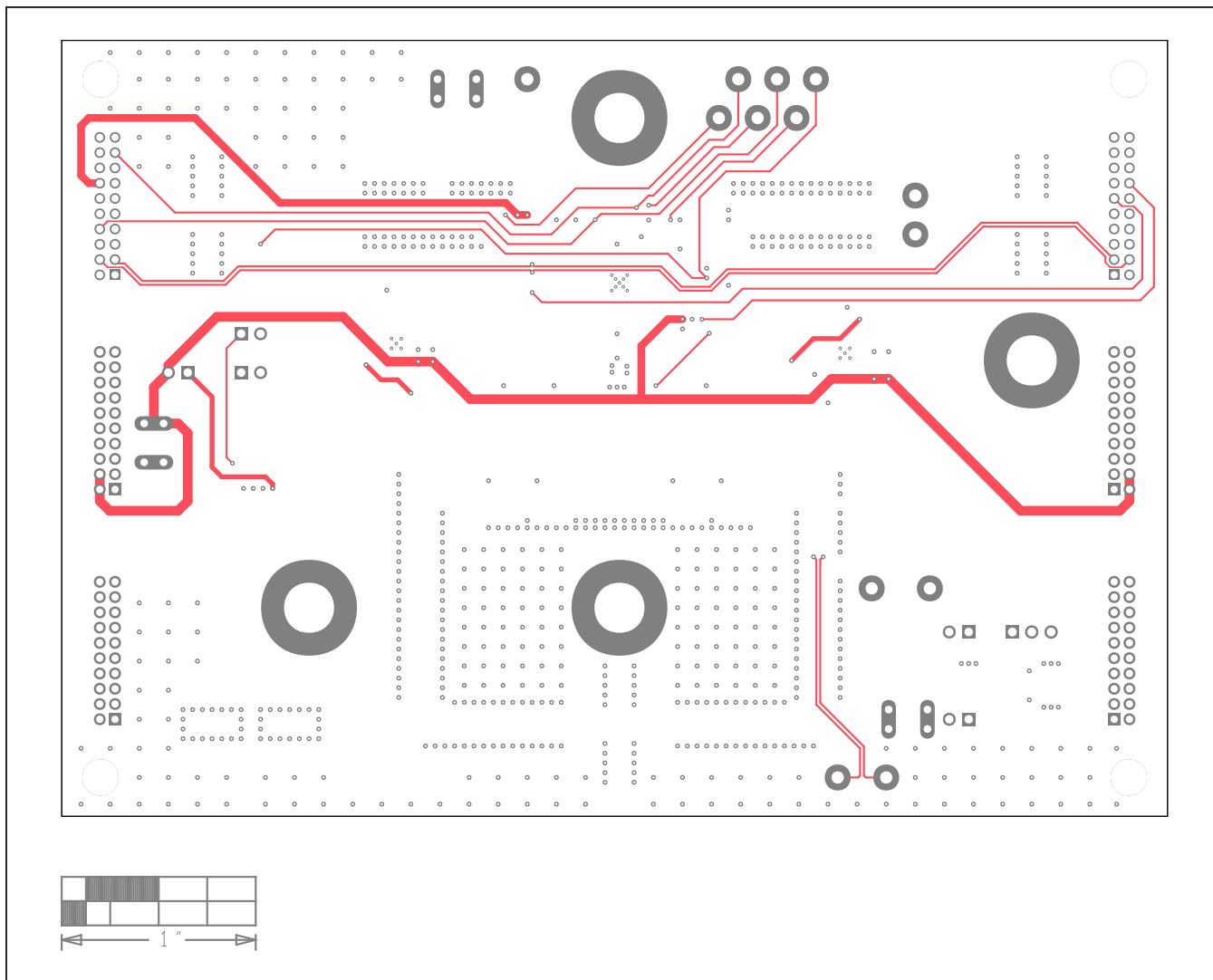

EV Kit PCB Layout—Internal Layer 4

EV Kit PCB Layout Diagrams (continued)

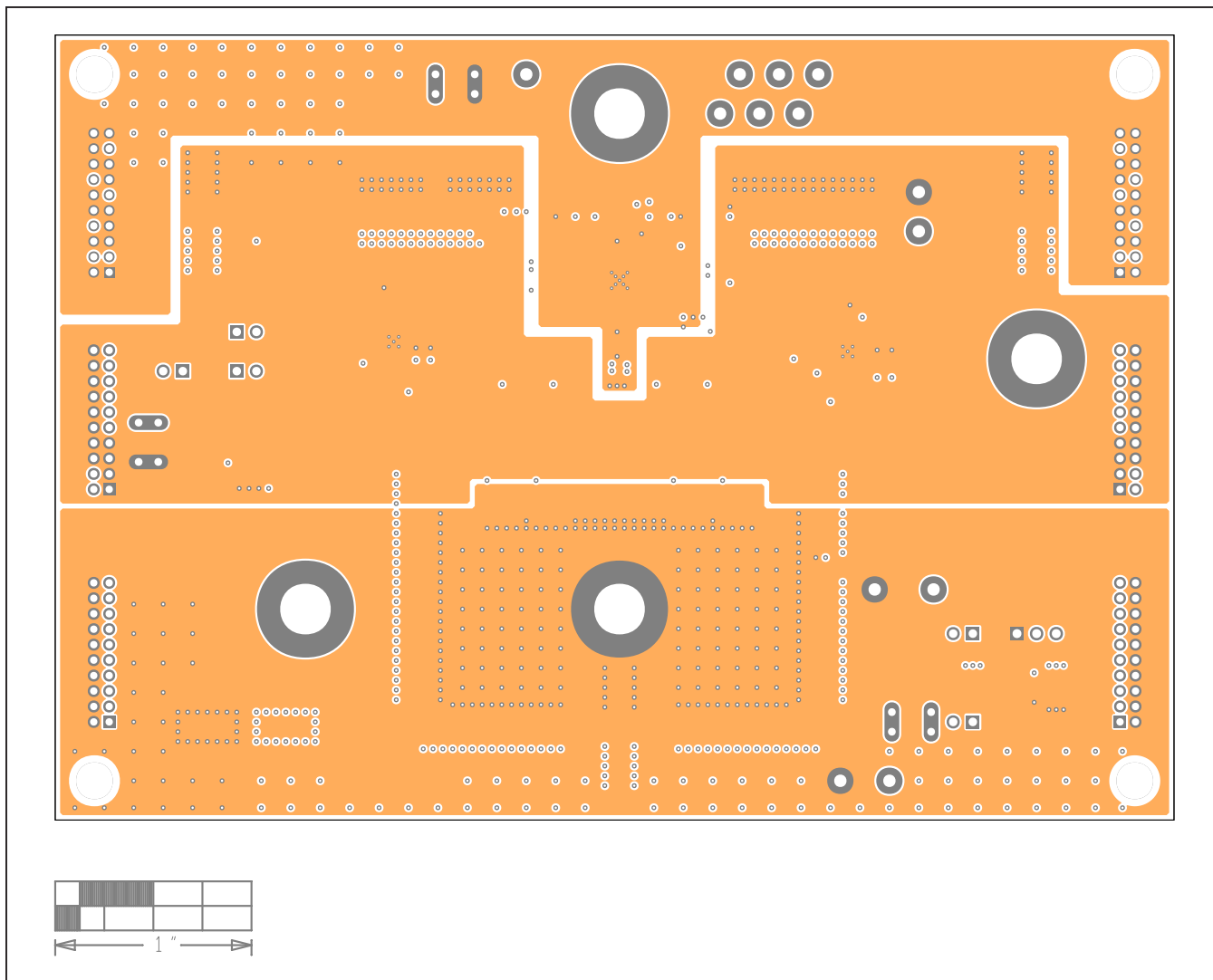

EV Kit PCB Layout—Internal Layer 5

EV Kit PCB Layout Diagrams (continued)

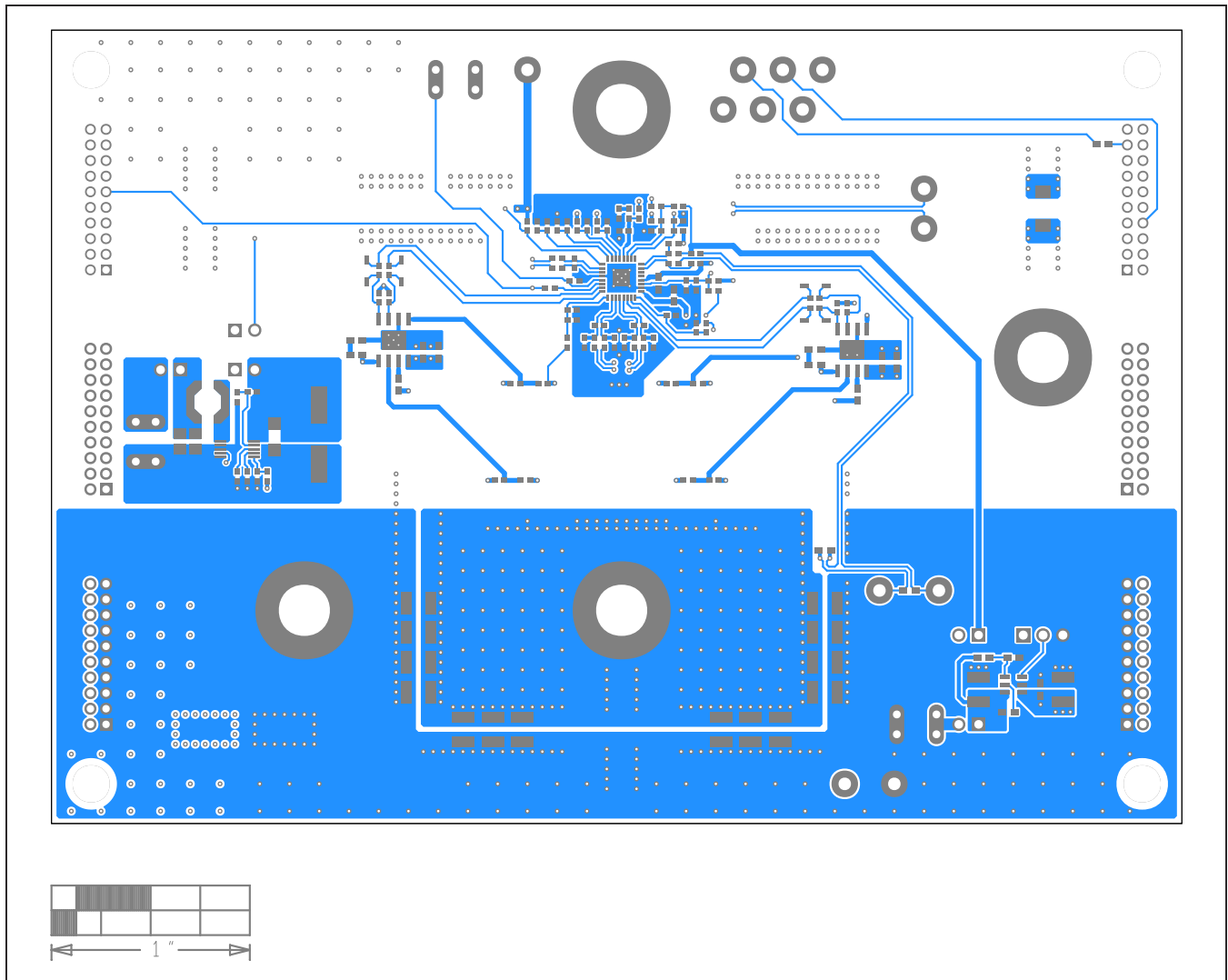

EV Kit PCB Layout—Bottom Layer

EV Kit PCB Layout Diagrams (continued)

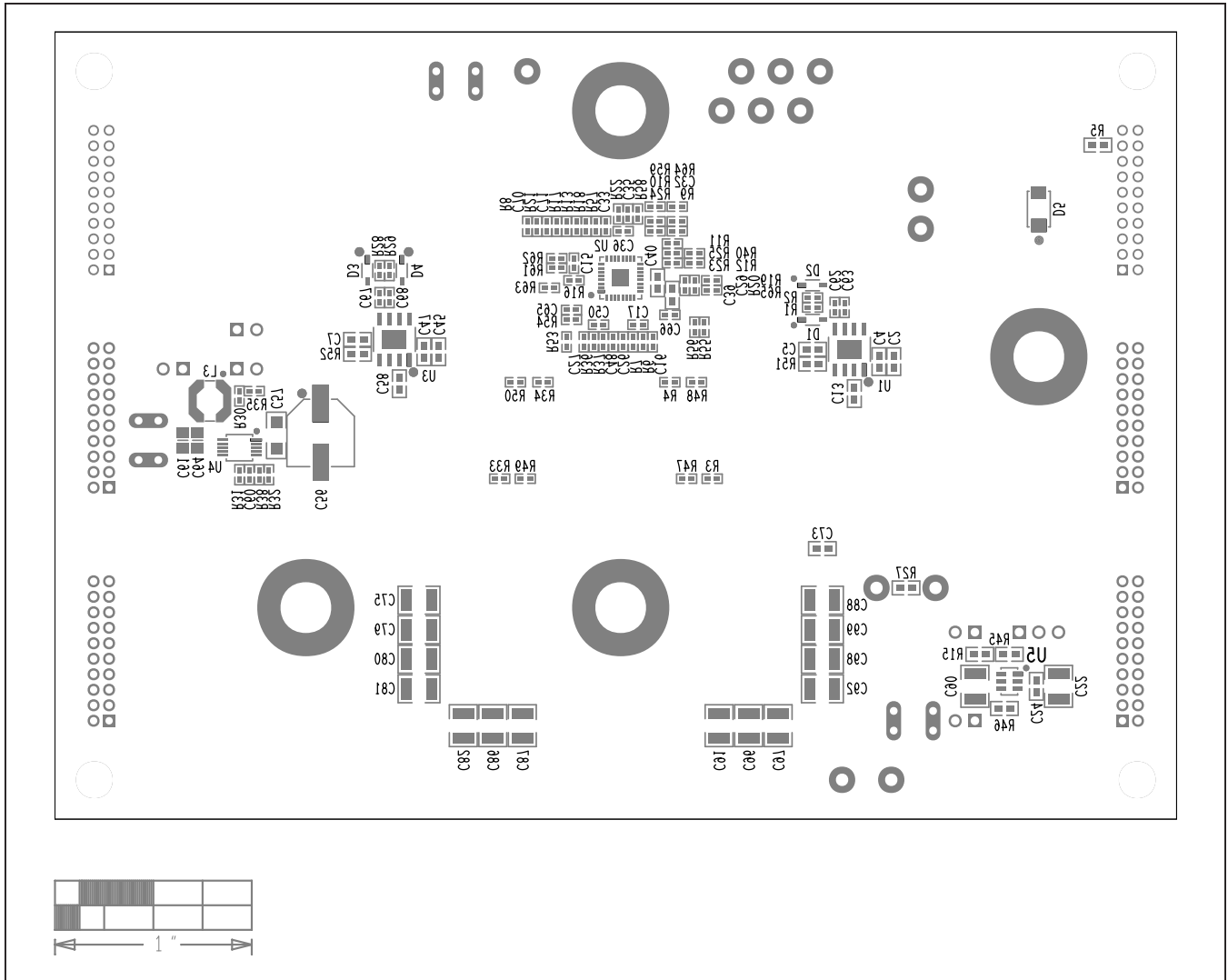

EV Kit Component Placement Guide—Bottom Silkscreen

MAX15158/MAX15158A/  
MAX15158Z Evaluation Kits

Evaluate: MAX15158  
MAX15158A  
MAX15158Z

## Revision History

REVISION NUMBER	REVISION DATE	DESCRIPTION	PAGES CHANGED
0	5/19	Initial release	—
1	6/19	Changed part number to MAX15158Z, updated BOM, schematic, and PCB layout diagrams	1–15
2	12/19	Added MAX15158 and MAX15158A part numbers, updated BOM, schematics, and PCB layout diagrams	1–15

For pricing, delivery, and ordering information, please visit Maxim Integrated's online storefront at <https://www.maximintegrated.com/en/storefront/storefront.html>.

*Maxim Integrated cannot assume responsibility for use of any circuitry other than circuitry entirely embodied in a Maxim Integrated product. No circuit patent licenses are implied. Maxim Integrated reserves the right to change the circuitry and specifications without notice at any time.*

## X-ON Electronics

Largest Supplier of Electrical and Electronic Components

*Click to view similar products for [Power Management IC Development Tools](#) category:*

*Click to view products by [Maxim](#) manufacturer:*

Other Similar products are found below :

[EVB-EP5348UI](#) [MIC23451-AAAYFL EV](#) [MIC5281YMME EV](#) [124352-HMC860LP3E](#) [DA9063-EVAL](#) [ADP122-3.3-EVALZ](#) [ADP130-0.8-EVALZ](#) [ADP130-1.8-EVALZ](#) [ADP1740-1.5-EVALZ](#) [ADP1870-0.3-EVALZ](#) [ADP1874-0.3-EVALZ](#) [ADP199CB-EVALZ](#) [ADP2102-1.25-EVALZ](#) [ADP2102-1.875EVALZ](#) [ADP2102-1.8-EVALZ](#) [ADP2102-2-EVALZ](#) [ADP2102-3-EVALZ](#) [ADP2102-4-EVALZ](#) [AS3606-DB](#) [BQ25010EVM](#) [BQ3055EVM](#) [ISLUSBI2CKIT1Z](#) [LP38512TS-1.8EV](#) [EVAL-ADM1186-1MBZ](#) [EVAL-ADM1186-2MBZ](#) [ADP122UJZ-REDYKIT](#) [ADP166Z-REDYKIT](#) [ADP170-1.8-EVALZ](#) [ADP171-EVALZ](#) [ADP1853-EVALZ](#) [ADP1873-0.3-EVALZ](#) [ADP198CP-EVALZ](#) [ADP2102-1.0-EVALZ](#) [ADP2102-1-EVALZ](#) [ADP2107-1.8-EVALZ](#) [ADP5020CP-EVALZ](#) [CC-ACC-DBMX-51](#) [ATPL230A-EK](#) [MIC23250-S4YMT EV](#) [MIC26603YJL EV](#) [MIC33050-SYHL EV](#) [TPS60100EVM-131](#) [TPS65010EVM-230](#) [TPS71933-28EVM-213](#) [TPS72728YFFEVM-407](#) [TPS79318YEQEVM](#) [UCC28810EVM-002](#) [XILINXPWR-083](#) [LMR22007YMINI-EVM](#) [LP38501ATJ-EV](#)