

## General Description

The MAX15462B evaluation kit (EV kit) is a fully assembled and tested circuit board that demonstrates the performance of the MAX15462B 42V, 300mA ultra-small, high-efficiency, synchronous step-down converter. The EV kit operates over a wide 6.5V to 42V input voltage range, and provides up to 300mA at the preset 5V output. The device features undervoltage lockout, overcurrent protection, and thermal shutdown. The EV kit switches at a fixed frequency of 500kHz, and delivers a peak efficiency of 92% with the supplied components.

The EV kit comes installed with the MAX15462BATA+ in an 8-pin (2mm x 2mm) lead(Pb)-free/RoHS-compliant TDFN package.

## Benefits and Features

- 6.5V to 42V Input Voltage Range
- 5V Output, 300mA Continuous Current
- Internal Compensation
- EN/UVLO for On/Off Control and Programmable Input Undervoltage Lockout
- 92% Peak Efficiency
- 500kHz Fixed-Frequency PWM Operation
- PFM or Forced-PWM Mode of Operation
- Hiccup Mode Overcurrent Protection
- Open-Drain  $\overline{\text{RESET}}$  Output
- Thermal Shutdown
- Proven PCB Layout
- Fully Assembled and Tested

Ordering Information appears at end of data sheet.

## Quick Start

### Recommended Equipment

- MAX15462B EV kit
- 42V adjustable, 0.5A DC power supply
- Electronic load up to 300mA
- Voltmeter

### Procedure

The EV kit is fully assembled and tested. Follow the steps below to verify board operation. **Caution: Do not turn on the power supply until all connections are completed.**

- 1) Verify that shunts are installed on jumpers JU1 and JU2 (EN/UVLO).
- 2) Verify that jumper JU3 (MODE PFM operation) is open.
- 3) Set the electronic load to constant-current mode, 300mA, and disable the electronic load.
- 4) Connect the electronic load's positive terminal to the VOUT PCB pad. Connect the negative terminal to the GND PCB pad.
- 5) Connect the voltmeter across the VOUT and GND PCB pads.
- 6) Set the power supply output to 24V. Disable the power supply.
- 7) Connect the 24V power supply output to the VIN PCB pad. Connect the supply ground to the GND PCB pad.
- 8) Turn on the power supply and verify that  $V_{\text{OUT}}$  is at 5V with respect to GND.
- 9) Enable the electronic load and verify that  $V_{\text{OUT}}$  is at 5V with respect to GND.

### Detailed Description

The MAX15462B EV kit is a fully assembled and tested circuit board that demonstrates the performance of the MAX15462B 42V, 300mA ultra-small, high-efficiency, synchronous step-down converter. The EV kit operates over a wide 6.5V to 42V input voltage range, and provides up to 300mA at the preset 5V output. The device features undervoltage lockout, overcurrent protection, and thermal shutdown. The EV kit switches at a fixed frequency of 500kHz, and delivers a peak efficiency of 92% with the supplied components.

The EV kit includes an EN/UVLO PCB pad and jumpers JU1 and JU2 to enable control of the converter output. The MODE PCB pad and jumper JU3 are provided for selecting the mode of operation of the converter. The VCC PCB pad helps measure the internal LDO voltage. An additional  $\overline{\text{RESET}}$  PCB pad is available for monitoring the open-drain logic output.

#### Enable Control (JU1, JU2)

The EN/UVLO pin of the device serves as an on/off control while also allowing the user to program the input

undervoltage-lockout (UVLO) threshold. Jumpers JU1 and JU2 configure the EV kit's output for turn-on/turn-off control. Install a shunt across pins 1-2 on jumper JU2 to disable  $V_{\text{OUT}}$ . See [Table 1](#) for proper jumper settings.

Additionally, resistors R1 and R2 are included to set the UVLO to a desired turn-on voltage. Refer to the *Enable Input (EN/UVLO)*, *Soft-Start* section in the MAX15462 IC data sheet for additional information on setting the UVLO threshold voltage.

#### Active-Low, Open-Drain Reset Output ( $\overline{\text{RESET}}$ )

The EV kit provides a PCB pad to monitor the status of the  $\overline{\text{RESET}}$  output.  $\overline{\text{RESET}}$  goes high when  $V_{\text{OUT}}$  rises above 95% (typ) of its nominal regulated output voltage. When  $V_{\text{OUT}}$  falls below 92% (typ) of its nominal regulated voltage,  $\overline{\text{RESET}}$  is pulled low.

#### PFM or Forced-PWM Mode (MODE)

The EV kit includes a jumper (JU3) to program the mode of operation of the converter. Install a shunt across JU3 before powering-up the EV kit to enable the forced-PWM operation. Keep JU3 open to enable light-load PFM operation. See [Table 2](#) for proper JU3 configuration.

**Table 1. Enable Control (EN/UVLO)**

SHUNT POSITION		EN/UVLO PIN	VOUT OUTPUT
JU1	JU2		
1-2	Open	Connected to VIN	Enabled
Open	1-2	Connected to GND	Disabled
1-2*	1-2*	Connected to midpoint of the R1, R2 resistor-divider	Enabled at VIN ≥ 6.5V

\*Default position.

**Table 2. Mode Control (JU3)**

SHUNT POSITION	MODE PIN	MODE OF OPERATION
1-2	Connected to GND	Forced PWM
Open*	Unconnected	PFM

\*Default position.

EV Kit Performance Report

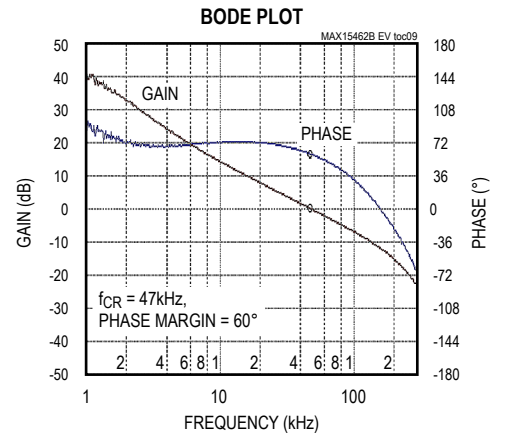
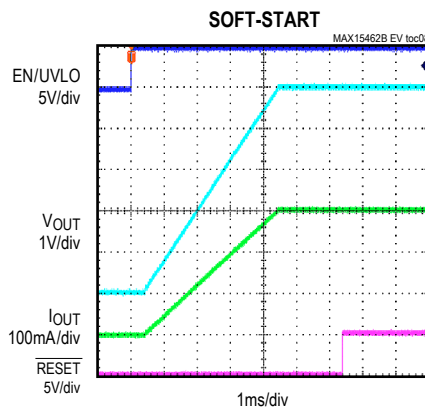
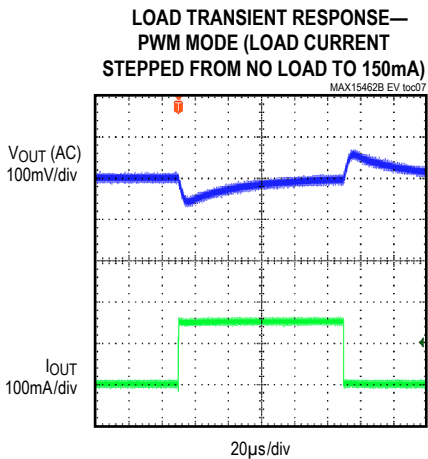
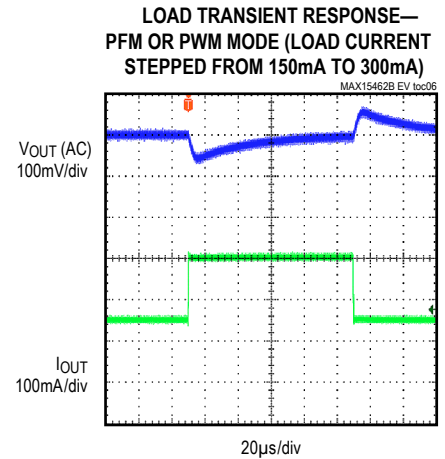
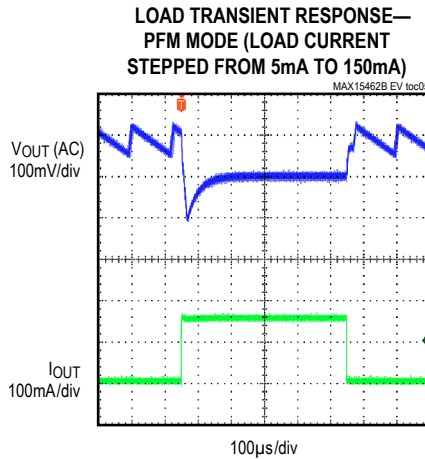
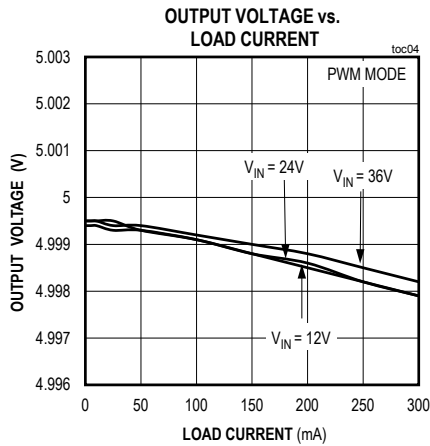
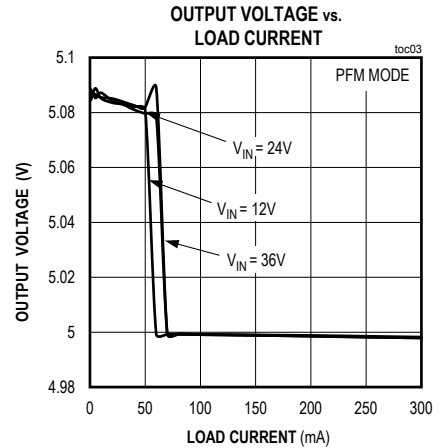
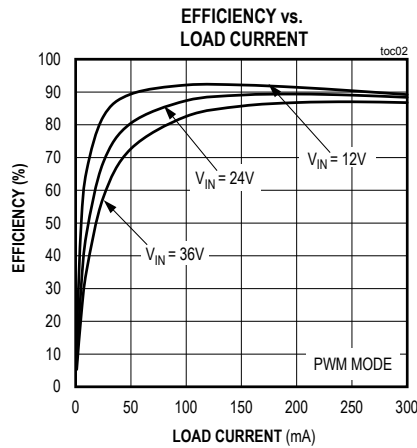
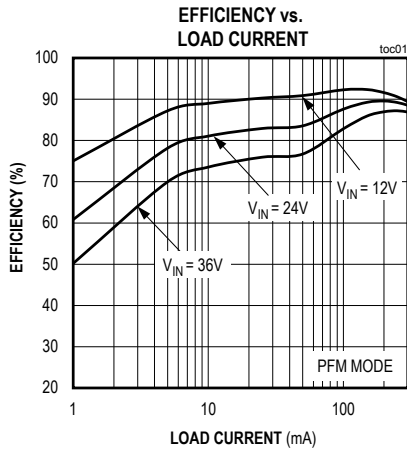

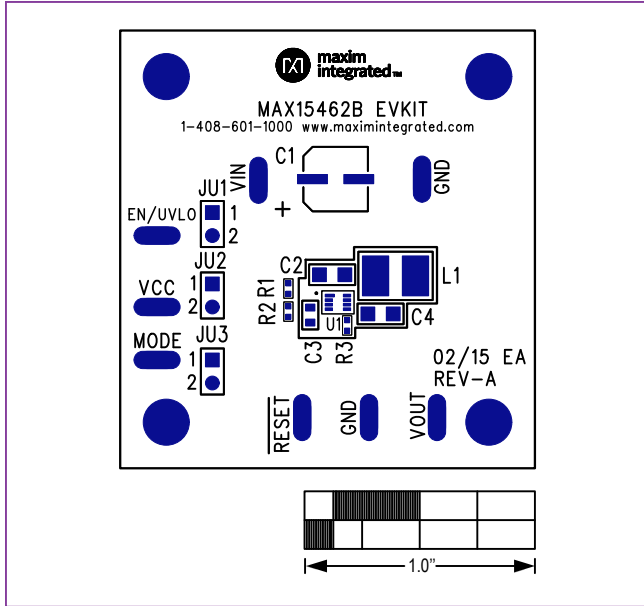

Figure 1. MAX15462B EV Kit Component Placement Guide—Component Side

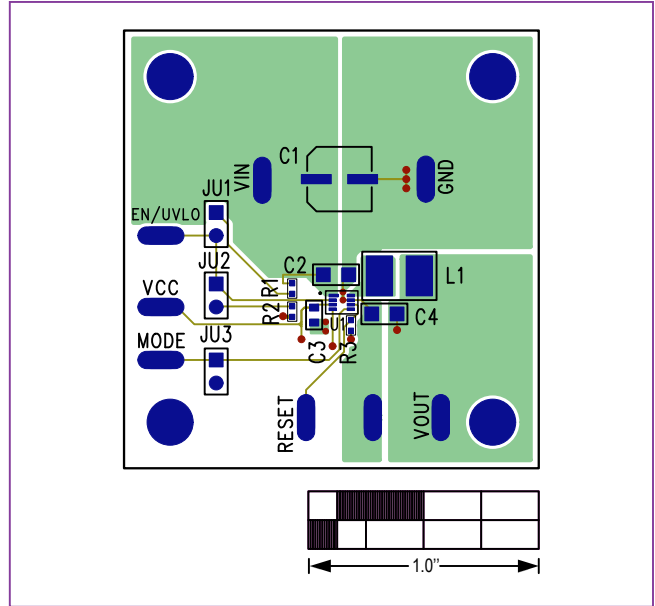

Figure 2. MAX15462B EV Kit PCB Layout—Component Side

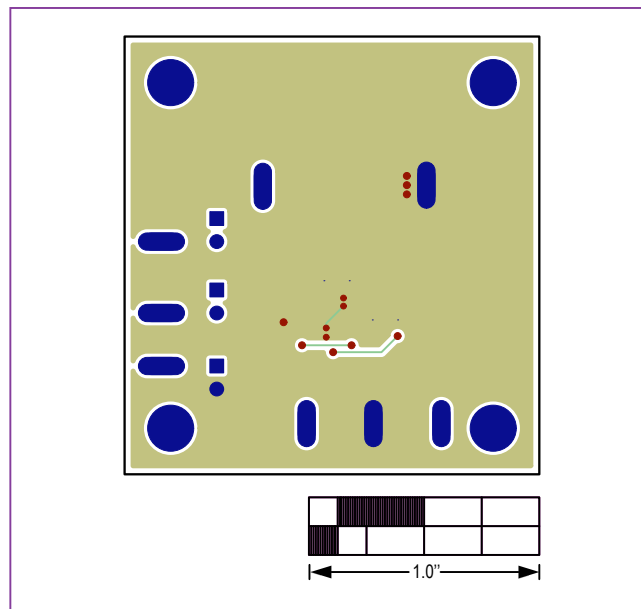

Figure 3. MAX15462B EV Kit PCB Layout—Solder Side

## Component Suppliers

SUPPLIER	WEBSITE
Coilcraft, Inc.	www.coilcraft.com
Murata Americas	www.murata.com
Panasonic Corp.	www.panasonic.com

**Note:** Indicate that you are using the MAX15462B when contacting these component suppliers.

## Component Information and Schematic

See the following links for component information and schematic:

- [MAX15462B EV BOM](#)
- [MAX15462B EV Schematic](#)

## Ordering Information

PART	TYPE
MAX15462BEVKIT#	EVKIT

#Denotes RoHS compliant.

## Revision History

REVISION NUMBER	REVISION DATE	DESCRIPTION	PAGES CHANGED
0	3/15	Initial release	—

For pricing, delivery, and ordering information, please contact Maxim Direct at 1-888-629-4642, or visit Maxim Integrated's website at [www.maximintegrated.com](http://www.maximintegrated.com).

*Maxim Integrated cannot assume responsibility for use of any circuitry other than circuitry entirely embodied in a Maxim Integrated product. No circuit patent licenses are implied. Maxim Integrated reserves the right to change the circuitry and specifications without notice at any time.*

5

4

3

D

C

B

A

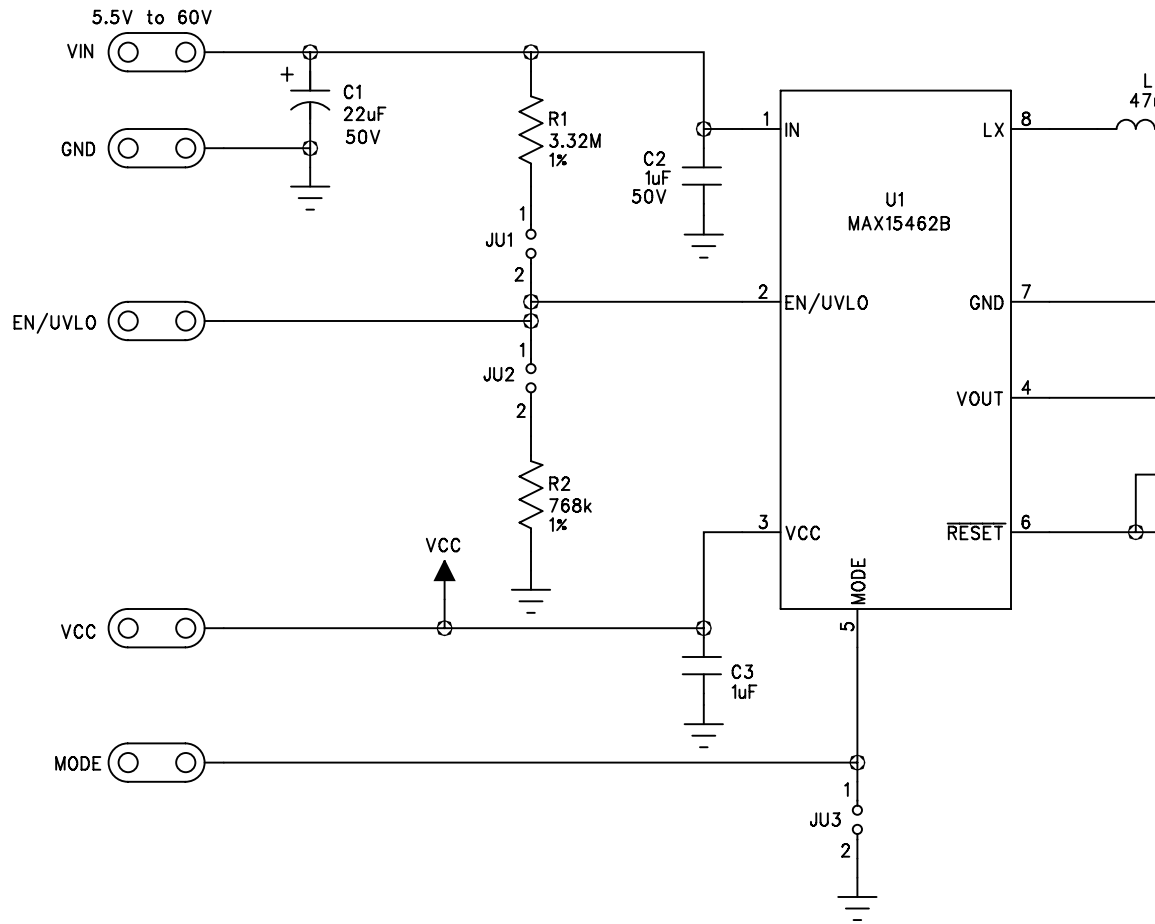

\_\_\_\_\_  
\_\_\_\_\_  
\_\_\_\_\_

**Jumper Table**

<b>JUMPER</b>	<b>SHUNT POSITION</b>
JU1	1,2 SHORT
JU2	1,2 SHORT
JU3	OPEN



## X-ON Electronics

Largest Supplier of Electrical and Electronic Components

*Click to view similar products for [Power Management IC Development Tools](#) category:*

*Click to view products by [Maxim](#) manufacturer:*

Other Similar products are found below :

[EVB-EP5348UI](#) [MIC23451-AAAYFL EV](#) [MIC5281YMME EV](#) [124352-HMC860LP3E](#) [DA9063-EVAL](#) [ADP122-3.3-EVALZ](#) [ADP130-0.8-EVALZ](#) [ADP130-1.8-EVALZ](#) [ADP1740-1.5-EVALZ](#) [ADP1870-0.3-EVALZ](#) [ADP1874-0.3-EVALZ](#) [ADP199CB-EVALZ](#) [ADP2102-1.25-EVALZ](#) [ADP2102-1.875EVALZ](#) [ADP2102-1.8-EVALZ](#) [ADP2102-2-EVALZ](#) [ADP2102-3-EVALZ](#) [ADP2102-4-EVALZ](#) [AS3606-DB](#) [BQ25010EVM](#) [BQ3055EVM](#) [ISLUSBI2CKIT1Z](#) [LP38512TS-1.8EV](#) [EVAL-ADM1186-1MBZ](#) [EVAL-ADM1186-2MBZ](#) [ADP122UJZ-REDYKIT](#) [ADP166Z-REDYKIT](#) [ADP170-1.8-EVALZ](#) [ADP171-EVALZ](#) [ADP1853-EVALZ](#) [ADP1873-0.3-EVALZ](#) [ADP198CP-EVALZ](#) [ADP2102-1.0-EVALZ](#) [ADP2102-1-EVALZ](#) [ADP2107-1.8-EVALZ](#) [ADP5020CP-EVALZ](#) [CC-ACC-DBMX-51](#) [ATPL230A-EK](#) [MIC23250-S4YMT EV](#) [MIC26603YJL EV](#) [MIC33050-SYHL EV](#) [TPS60100EVM-131](#) [TPS65010EVM-230](#) [TPS71933-28EVM-213](#) [TPS72728YFFEVM-407](#) [TPS79318YEQEVM](#) [UCC28810EVM-002](#) [XILINXPWR-083](#) [LMR22007YMINI-EVM](#) [LP38501ATJ-EV](#)