

## MAX16128/MAX16129

## Load-Dump/Reverse-Voltage Protection Circuits

### General Description

The MAX16128/MAX16129 load-dump/reverse-voltage protection circuits protect power supplies from damaging input-voltage conditions, including overvoltage, reverse-voltage, and high-voltage transient pulses. Using a built-in charge pump, the devices control two external back-to-back n-channel MOSFETs that turn off and isolate downstream power supplies during damaging input conditions, such as an automotive load-dump pulse or a reverse-battery condition. Operation is guaranteed down to 3V that ensures proper operation during automotive cold-crank conditions. These devices feature a flag output ( $\overline{\text{FLAG}}$ ) that asserts during fault conditions.

For reverse-voltage protection, external back-to-back MOSFETs outperform the traditional reverse-battery diode, minimizing the voltage drop and power dissipation during normal operation.

The devices use fixed overvoltage and undervoltage thresholds, minimizing the external component count.

The MAX16129 provides limiter-mode fault management for overvoltage and thermal-shutdown conditions; whereas the MAX16128 provides switch-mode fault management for overvoltage and thermal shutdown conditions. In the limiter mode, the output voltage is limited and  $\overline{\text{FLAG}}$  is asserted low during a fault. In the switch mode, the external MOSFETs are switched off and  $\overline{\text{FLAG}}$  is asserted low after a fault. The switch mode is available in four options—Latch mode, 1 Autoretry mode, 3 Autoretry mode, and Always autoretry mode.

The MAX16128/MAX16129 are available in an 8-pin  $\mu\text{MAX}^{\circledR}$  package and operate over the automotive temperature range (-40°C to +125°C).

### Applications

- Automotive
- Industrial
- Avionics
- Telecom/Server/Networking

### Benefits and Features

- Increases Protection of Sensitive Electronic Components in Harsh Environments
  - -36V to +90V Wide Input-Voltage Protection Range
  - Fast Gate Shutoff During Fault Conditions with Complete Load Isolation
  - Thermal Shutdown Protection
  - $\overline{\text{FLAG}}$  Output Identifies Fault Condition
- Automotive Qualified
  - Operates Down to +3V, Riding Out Cold-Crank Conditions
  - -40°C to +125°C Operating Temperature Range
- Integration Reduces Solution Size
  - Internal Charge-Pump Circuit Enhances External n-Channel MOSFET
  - Fixed Undervoltage/Overvoltage Thresholds
  - 3mm × 3mm, 8-Pin  $\mu\text{MAX}$  Package
- Reduced Power Dissipation Compared to Discrete Solutions
  - Minimal Operating Voltage Drop for Reverse-Voltage Protection
  - 380 $\mu\text{A}$  Supply Current and 100 $\mu\text{A}$  Shutdown Current at 30V Input

Ordering Information appears at end of data sheet.

$\mu\text{MAX}$  is a registered trademark of Maxim Integrated Products, Inc.

### Absolute Maximum Ratings

(All pins referenced to GND.)

IN	-36V to +90V
SHDN	-0.3V to max (0V, V <sub>IN</sub> + 0.3V)
SRC, GATE	-36V to +45V
SRC to GATE	-36V to +30V
OUT	-0.3V to +45V
FLAG	-0.3V to +45V
Continuous Sink/Source (All Pins)	±100mA

Continuous Power Dissipation (T <sub>A</sub> = +70°C) (multilayer board)	
μMAX (derate 12.9mW/°C above +70°C)	1030.9mW
Operating Temperature Range	-40°C to +125°C
Junction Temperature	+150°C
Storage Temperature Range	-60°C to +150°C
Lead Temperature (soldering, 10s)	+300°C
Soldering Temperature (reflow)	+260°C

Stresses beyond those listed under "Absolute Maximum Ratings" may cause permanent damage to the device. These are stress ratings only, and functional operation of the device at these or any other conditions beyond those indicated in the operational sections of the specifications is not implied. Exposure to absolute maximum rating conditions for extended periods may affect device reliability.

### Package Thermal Characteristics (Note 1)

μMAX

Junction-to-Ambient Thermal Resistance (θ <sub>JA</sub> )	77.6°C/W
Junction-to-Case Thermal Resistance (θ <sub>JC</sub> )	5°C/W

**Note 1:** Package thermal resistances were obtained using the method described in JEDEC specification JESD51-7, using a four-layer board. For detailed information on package thermal considerations, refer to [www.maximintegrated.com/thermal-tutorial](http://www.maximintegrated.com/thermal-tutorial).

### Electrical Characteristics

(V<sub>IN</sub> = 12V, C<sub>GATE-SOURCE</sub> = 1nF, T<sub>A</sub> = -40°C to +125°C, unless otherwise noted. Typical values are at T<sub>A</sub> = +25°C.) (Note 2)

PARAMETER	SYMBOL	CONDITIONS	MIN	TYP	MAX	UNITS
Input Voltage Range	V <sub>IN</sub>	Operating range	3		30	V
		Protection range	-36		+90	
Input Supply Current	I <sub>IN</sub>	SHDN = high	V <sub>IN</sub> = V <sub>SRC</sub> = V <sub>OUT</sub> = 12V	260	360	μA
			V <sub>IN</sub> = V <sub>SRC</sub> = V <sub>OUT</sub> = 30V	290	400	
		SHDN = low	V <sub>IN</sub> = 12V	44	60	
			V <sub>IN</sub> = 30V	64	100	
SRC Input Current	I <sub>SRC</sub>	V <sub>IN</sub> = V <sub>SRC</sub> = 12V, SHDN = high		36	200	μA
		V <sub>IN</sub> = V <sub>SRC</sub> = 30V, SHDN = high		240	350	
Internal Undervoltage Threshold	V <sub>UV_TH</sub>	V <sub>IN</sub> rising	0.97 × V <sub>UV</sub>	V <sub>UV</sub>	1.03 × V <sub>UV</sub>	V
Internal Undervoltage-Threshold Hysteresis	V <sub>UV_HYS</sub>			0.05 × V <sub>UV</sub>		V
Internal Overvoltage Threshold	V <sub>OV_TH</sub>	V <sub>IN</sub> rising	0.97 × V <sub>OV</sub>	V <sub>OV</sub>	1.03 × V <sub>OV</sub>	V
Internal Overvoltage-Threshold Hysteresis	V <sub>OV_HYS</sub>			0.05 × V <sub>OV</sub>		V

### Electrical Characteristics (continued)

( $V_{IN} = 12V$ ,  $C_{GATE-SOURCE} = 1nF$ ,  $T_A = -40^{\circ}C$  to  $+125^{\circ}C$ , unless otherwise noted. Typical values are at  $T_A = +25^{\circ}C$ .) (Note 2)

PARAMETER	SYMBOL	CONDITIONS	MIN	TYP	MAX	UNITS
Internal Cold-Crank Threshold	$V_{CCK}$	$V_{IN}$ falling	$0.97 \times V_{CCK}$	$V_{CCK}$	$1.03 \times V_{CCK}$	V
Internal Cold-Crank Threshold Hysteresis	$V_{CCK\_HYS}$			$0.05 \times V_{CCK}$		V
OUT Input Resistance to Ground	$R_{OUT}$	MAX16128		4		$M\Omega$
		MAX16129		2		
POK Threshold Rising	$V_{POK+}$			$0.9 \times V_{IN}$		V
POK Threshold Falling	$V_{POK-}$			$0.87 \times V_{IN}$		V
Startup Response Time	$t_{START}$	(Note 3)		150		$\mu s$
Autoretry Timeout	$t_{RETRY}$			150		ms
GATE Rise Time	$t_{RISE}$	$V_{GATE}$ rising (GND to $V_{SRC} + 8V$ )		1		ms
Overshoot-to-GATE Propagation Delay	$t_{OVG}$	$V_{IN}$ rising (MAX16128) from $(0.9 \times V_{OV\_TH})$ to $(1.1 \times V_{OV\_TH})$ , $V_{OUT}$ rising (MAX16129) from $(0.9 \times V_{OV\_TH})$ to $(1.1 \times V_{OV\_TH})$		1		$\mu s$
Undervoltage-to-GATE Propagation Delay	$t_{UVG}$	$V_{IN}$ falling from $(1.1 \times V_{UV\_TH})$ to $(0.9 \times V_{UV\_TH})$		21		$\mu s$
Overshoot to $\overline{FLAG}$ Propagation Delay	$t_{OV}$	$V_{IN}$ rising (MAX16128) from $(0.9 \times V_{OV\_TH})$ to $(1.1 \times V_{OV\_TH})$ , $V_{OUT}$ rising (MAX16129) from $(0.9 \times V_{OV\_TH})$ to $(1.1 \times V_{OV\_TH})$		1		$\mu s$
GATE Output Voltage High Above $V_{SRC}$	$V_{GS}$	$V_{IN} = V_{SRC} = V_{OUT} = 3V$ , $I_{GATE} = -1\mu A$	4.25	5	5.5	V
		$V_{IN} = V_{SRC} = V_{OUT} = 12V$ , $I_{GATE} = -1\mu A$	8	9	10	
		$V_{IN} = V_{SRC} = V_{OUT} = 24V$ , $I_{GATE} = -1\mu A$	7	8.5	10	
		$V_{IN} = V_{SRC} = V_{OUT} = 30V$ , $I_{GATE} = -1\mu A$	6.25	8	9.5	
GATE Pulldown Current	$I_{PD}$	$V_{GATE} = 12V$	8.8			mA
GATE Charge-Pump Current	$I_{GATE}$	$V_{IN} = V_{GATE} = V_{SRC} = 12V$	180			$\mu A$
Thermal Shutdown	$T_+$			+145		$^{\circ}C$
Thermal-Shutdown Hysteresis	$\Delta T$			15		$^{\circ}C$
$\overline{SHDN}$ Logic-High Input Voltage	$V_{IH}$		1.4			V
$\overline{SHDN}$ Logic-Low Input Voltage	$V_{IL}$				0.4	V

**Electrical Characteristics (continued)**

( $V_{IN} = 12V$ ,  $C_{GATE-SOURCE} = 1nF$ ,  $T_A = -40^{\circ}C$  to  $+125^{\circ}C$ , unless otherwise noted. Typical values are at  $T_A = +25^{\circ}C$ .) (Note 2)

PARAMETER	SYMBOL	CONDITIONS	MIN	TYP	MAX	UNITS
SHDN Input Pulse Width	$t_{PW}$		6			$\mu s$
SHDN Input Pulldown Current	$I_{SPD}$			0.8	1.2	$\mu A$
FLAG Output Voltage Low	$V_{OL}$	FLAG sinking 1mA			0.4	V
FLAG Leakage Current	$I_{IL}$	$V_{FLAG} = 12V$			0.5	$\mu A$

**Note 2:** All parameters are production tested at  $T_A = +25^{\circ}C$ . Limits over the operating temperature range are guaranteed by design and characterization.

**Note 3:** The MAX16128/MAX16129 power up with the external MOSFETs in off mode ( $V_{GATE} = V_{SRC}$ ). The external MOSFETs turn on  $t_{START}$  after the devices are powered up and all input conditions are valid.

**Typical Operating Characteristics**

( $V_{IN} = 12V$ ,  $T_A = +25^{\circ}C$ , unless otherwise noted.)

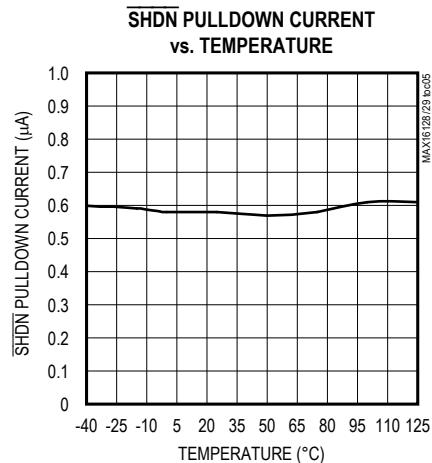
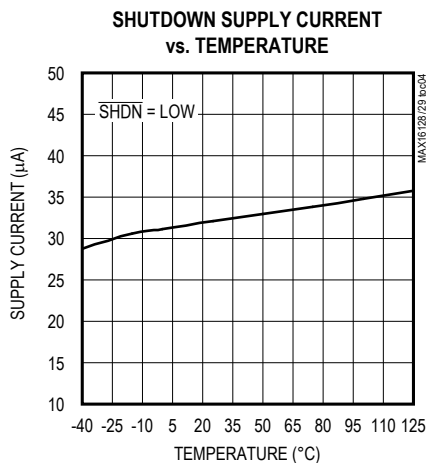
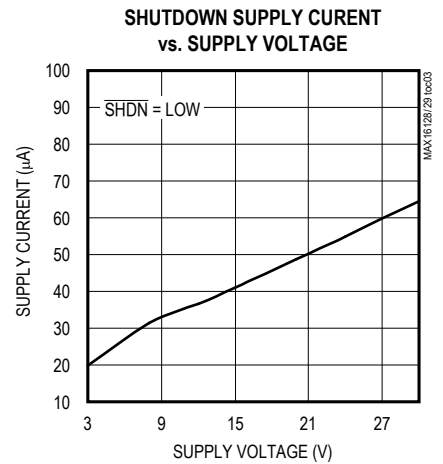
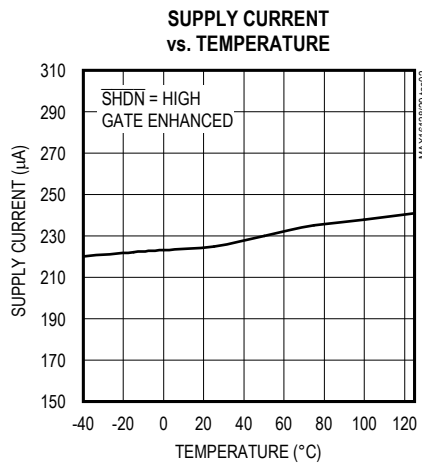
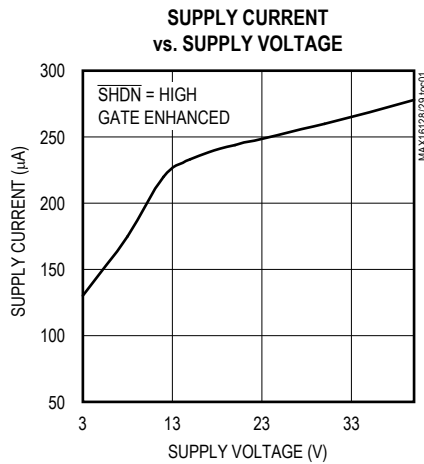

Typical Operating Characteristics (continued)

( $V_{IN} = 12V$ ,  $T_A = +25^\circ C$ , unless otherwise noted.)

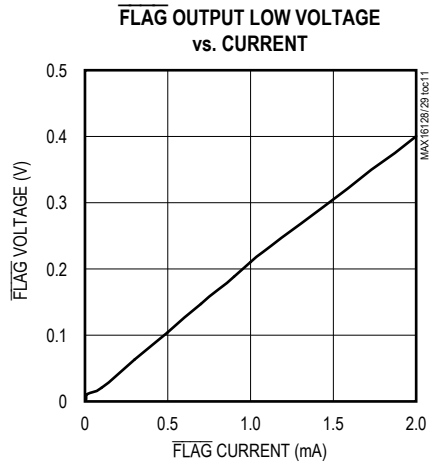
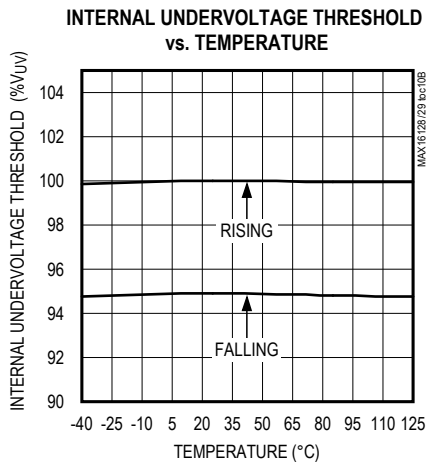
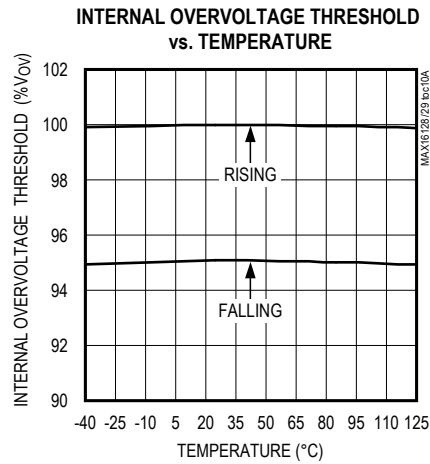
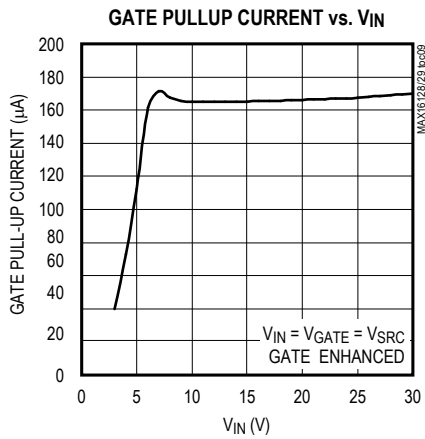
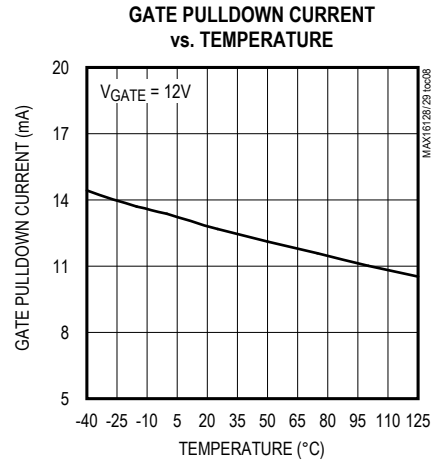
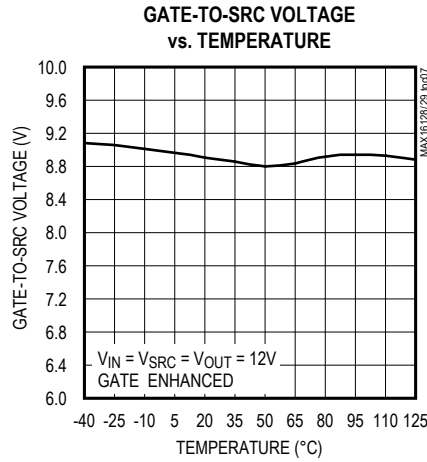
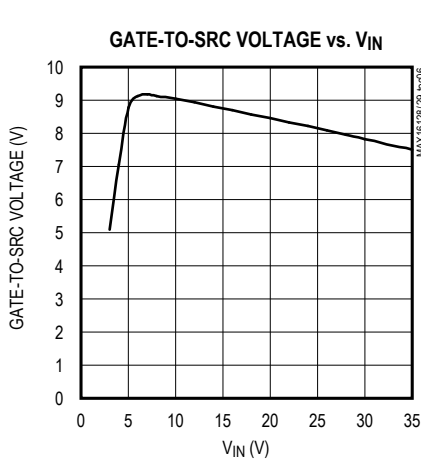

Typical Operating Characteristics (continued)

( $V_{IN} = 12V$ ,  $T_A = +25^{\circ}C$ , unless otherwise noted.)

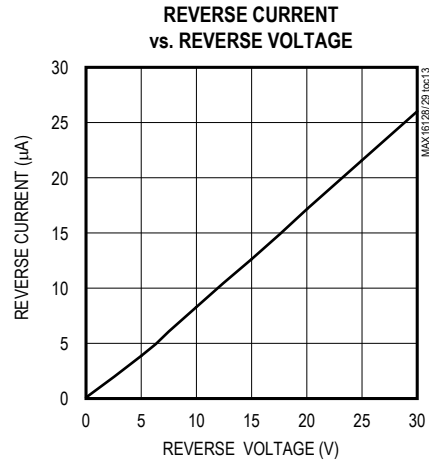
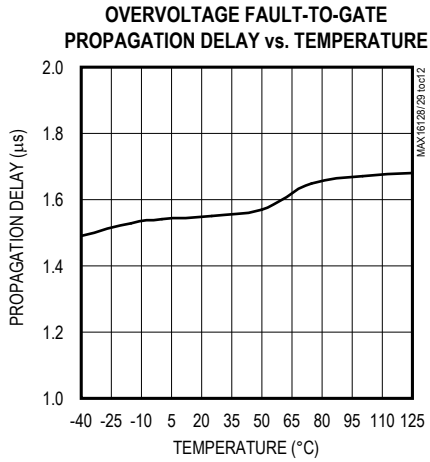

**STARTUP WAVEFORM**  
( $V_{IN}$  PULSED 0 TO 12V,  $R_{LOAD} = 100\Omega$ ,  
 $C_{IN} = 0.1\mu F$ ,  $C_{OUT} = 10\mu F$ )

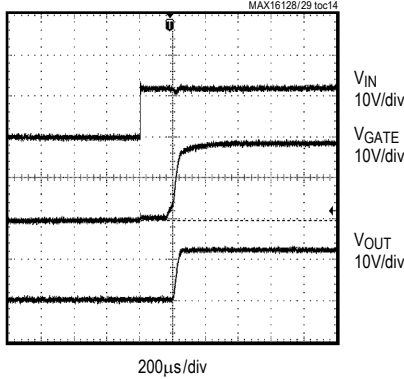

**STARTUP FROM SHUTDOWN ( $\overline{SHDN}$ )**  
RISING FROM 0 TO 2V,  $V_{IN} = 12V$ ,  
 $R_{LOAD} = 100\Omega$ ,  $C_{IN} = 0.1\mu F$

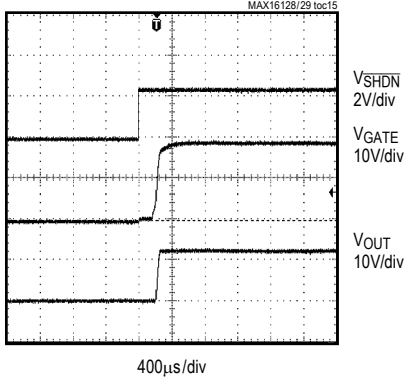

**OVERVOLTAGE SWITCH FAULT**  
( $V_{OV} = 21V$ ,  $C_{IN} = 0.1\mu F$ ,  $C_{OUT} = 10\mu F$ )

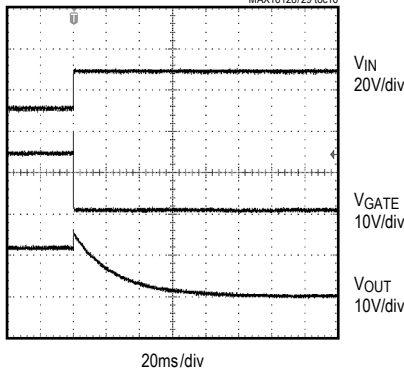

**OVERVOLTAGE LIMITER**  
( $V_{OV} = 21V$ ,  $C_{IN} = 0.1\mu F$ ,  $C_{OUT} = 10\mu F$ )

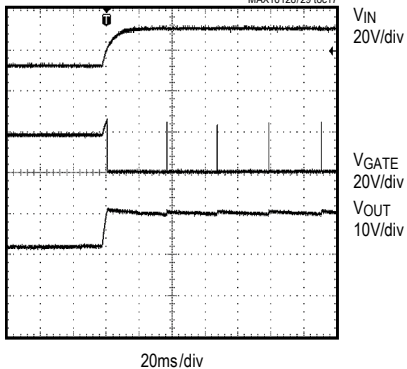

### Pin Configuration

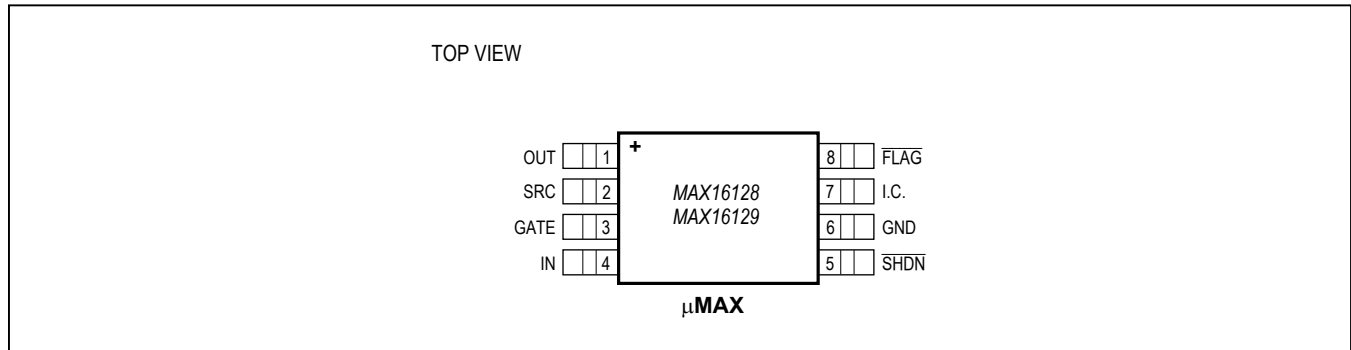

### Pin Description

PIN	NAME	FUNCTION
1	OUT	Output Voltage-Sense Input. Connect OUT to the load with a 100Ω series resistor. Bypass with a minimum 10μF capacitor to GND.
2	SRC	Source Input. Connect SRC to the common source connection of the external MOSFETs. When the MOSFETs are turned off, this connection is clamped to GND. An external zener diode between SRC and GATE protects the gates of the external MOSFETs.
3	GATE	Gate-Driver Output. Connect GATE to the gates of the external n-channel MOSFETs. GATE is the charge-pump output during normal operation. GATE is quickly pulled low during a fault condition or when $\overline{\text{SHDN}}$ is pulled low.
4	IN	Positive Supply Input Voltage. Connect IN to the positive side of the input voltage. Bypass IN with a 0.1μF ceramic capacitor to GND.
5	$\overline{\text{SHDN}}$	Shutdown Input. Drive $\overline{\text{SHDN}}$ low to force GATE and $\overline{\text{FLAG}}$ low and turn off the external n-channel MOSFETs. Connect a 100kΩ resistor from $\overline{\text{SHDN}}$ to IN for normal operation.
6	GND	Ground
7	I.C.	Internally connected to GND
8	$\overline{\text{FLAG}}$	$\overline{\text{FLAG}}$ Output. During startup, $\overline{\text{FLAG}}$ is low as long as $V_{\text{OUT}}$ is lower than 90% of $V_{\text{IN}}$ and after that it is high impedance. It asserts low during shutdown mode, an overvoltage, thermal shutdown, or undervoltage fault or when $V_{\text{OUT}}$ falls below 90% of $V_{\text{IN}}$ . $\overline{\text{FLAG}}$ asserts low during a cold-crank fault to signal reverse-current protection.

## Detailed Description

The MAX16128/MAX16129 transient protection circuits are suitable for automotive and industrial applications where high-voltage transients are commonly present on supply voltage inputs. The devices monitor the input voltage and control two external common-source n-channel MOSFETs to protect downstream voltage regulators during load-dump events or other automotive pulse conditions.

The devices feature an overvoltage and an undervoltage comparator for voltage window detection. A flag output ( $\overline{\text{FLAG}}$ ) asserts when a fault event occurs.

Two external back-to-back n-channel MOSFETs provide reverse-voltage protection and also prevent reverse current during a fault condition. Compared to a traditional reverse-battery diode, this approach minimizes power dissipation and voltage drop.

The MAX16129 provides a limiter-mode fault management for overvoltage and thermal-shutdown conditions, whereas the MAX16128 provides switch-mode fault management for overvoltage and thermal-shutdown conditions. In the limiter mode, the MOSFETs cycle on and off so the output voltage is limited. In the switch mode, the external MOSFETs are switched off, disconnecting the load from the input. In both cases,  $\overline{\text{FLAG}}$  asserts to indicate a fault.

### Gate Charge Pump

The devices use a charge pump to generate the GATE to SRC voltage and enhance the external MOSFETs. After the input voltage exceeds the input undervoltage threshold, the charge pump turns on after a 150 $\mu$ s delay.

During a fault condition, GATE is pulled to ground with an 8.8mA (min) pulldown current. Note that an external zener diode is required to be connected between the gate and source of the external MOSFETs (see the [Applications Information](#) section).

### Overvoltage Protection

The devices detect overvoltage conditions using a comparator that is connected through an internal resistive divider to the input or output voltage. An overvoltage condition causes the GATE output to go low, turning off the external MOSFETs.  $\overline{\text{FLAG}}$  also asserts to indicate the fault condition.

### Overvoltage Limiter (MAX16129)

In overvoltage-limiter mode, the output voltage is regulated at the overvoltage-threshold voltage and continues to supply power to downstream devices. In this mode, the device operates like a voltage regulator.

During normal operation, GATE is enhanced 9V above SRC. The output voltage is monitored through an internal resistive divider. When OUT rises above the overvoltage threshold, GATE goes low and the MOSFETs turn off. As the voltage on OUT falls below the overvoltage threshold minus the threshold hysteresis, GATE goes high and the MOSFETs turn back on again, regulating OUT in a switched-linear mode at the overvoltage threshold.

The switching frequency depends on the gate charge of the MOSFETs, the charge-pump current, the output load current, and the output capacitance.

Caution must be exercised when operating the MAX16129 in voltage-limiting mode for long durations. Since MOSFETs can dissipate power continuously during this interval, proper heatsinking should be implemented to prevent damage to them.

### Overvoltage Switch (MAX16128)

In the overvoltage switch mode, the internal overvoltage comparator monitors the input voltage and the load is completely disconnected from the input during an overvoltage event. When the input voltage exceeds the overvoltage threshold, GATE goes low and the MOSFETs turn off, disconnecting the input from the load. After that, for the autoretry-mode version, the autoretry timer starts, while for the latched-mode version a power cycle to IN or a cycle on  $\overline{\text{SHDN}}$  is needed to turn the external MOSFETs back on.

The MAX16128 can be configured to latch off (suffix D) even after the overvoltage condition ends. The latch is cleared by cycling IN below the undervoltage threshold or by toggling  $\overline{\text{SHDN}}$ .

The devices can also be configured to retry:

- One time, then latch off (suffix B)
- Three times, then latch off (suffix C)
- Always retry and never latch off (suffix A)

There is a fixed 150ms (typ) delay between each retry attempt. If the overvoltage-fault condition is gone when a retry is attempted, GATE goes high and power is restored to the downstream circuitry.



### Undervoltage Protection

The devices monitor the input voltage for undervoltage conditions. If the input voltage is below the undervoltage threshold ( $V_{IN} < V_{UV\_TH} - V_{UV\_HYS}$ ), GATE goes low, turning off the external MOSFETs and  $\overline{FLAG}$  asserts. When the input voltage exceeds the undervoltage threshold ( $V_{IN} > V_{UV\_TH}$ ), GATE goes high after a 150 $\mu$ s delay (typ).

For the MAX16128/MAX16129, the undervoltage threshold is determined by the part number suffix option (see [Table 2](#)).

### Cold-Crank Monitoring

Cold-crank faults occur when the input voltage decreases from its steady-state condition. A cold-crank comparator monitors IN through an internal resistive divider. The MAX16128/MAX16129 offer two ways to handle this kind of fault depending on a part number suffix (see the [Selector Guide](#)):

- The cold-crank comparator is disabled and external MOSFETs stay on during the falling input-voltage transient unless the input voltage falls below the undervoltage threshold (see [Table 2](#)).
- The cold-crank comparator is enabled and external MOSFETs are switched off by pulling down GATE if the input voltage falls below the cold-crank threshold to avoid load discharge due to reverse current from OUT to IN (see [Table 4](#)).

In the last case, cold-crank protection is enabled as long as  $V_{OUT}$  is higher than 90% of  $V_{IN}$  (with a 3% hysteresis) and  $V_{IN}$  is higher than the undervoltage threshold. When the monitored input voltage falls below the falling cold-crank fault threshold ( $V_{IN} < V_{CCK}$ ), the GATE is pulled down and  $\overline{FLAG}$  is asserted low. When the input voltage rises back above the rising cold-crank fault threshold ( $V_{IN} > V_{CCK} + V_{CLK\_HYS}$ ),  $\overline{FLAG}$  is released and the charge pump enhances GATE above SRC, reconnecting the load to the input.

### Thermal Shutdown

The devices' thermal-shutdown feature turns off the MOSFETs if the internal die temperature exceeds 145°C ( $T_J$ ). By ensuring good thermal coupling between the MOSFETs and the devices, the thermal shutdown can turn off the MOSFETs if they overheat.

When the junction temperature exceeds  $T_J = +145^\circ\text{C}$  (typ), the internal thermal sensor signals the shutdown logic, pulling the GATE voltage low and allowing the device to cool. When  $T_J$  drops by 15°C (typ), GATE goes high and the MOSFETs turn back on. Do not exceed the

absolute maximum junction-temperature rating of  $T_J = +150^\circ\text{C}$ .

### Flag Output ( $\overline{FLAG}$ )

An open-drain  $\overline{FLAG}$  output indicates fault conditions. During startup,  $\overline{FLAG}$  is initially low and goes high impedance when  $V_{OUT}$  is greater than 90% of  $V_{IN}$  if no fault conditions are present.  $\overline{FLAG}$  asserts low during shutdown mode, an overvoltage, thermal shutdown, or undervoltage fault, or when  $V_{OUT}$  falls below 90% of  $V_{IN}$ . In the versions where the cold-crank comparator is enabled,  $\overline{FLAG}$  asserts low during a cold-crank fault.

### Reverse-Voltage Protection

The devices integrate reverse-voltage protection, preventing damage to the downstream circuitry caused by battery reversal or negative transients. The devices can withstand reverse voltage to -36V without damage to themselves or the load. During a reverse-voltage condition, the two external n-channel MOSFETs are turned off, protecting the load. Connect a 0.1 $\mu$ F ceramic capacitor from IN to GND connect a 10 $\mu$ F capacitor from OUT to GND, and minimize the parasitic capacitance from GATE to GND to have fast reverse-battery voltage-transient protection. During normal operation, both MOSFETs are turned on and have a minimal forward-voltage drop, providing lower power dissipation and a much lower voltage drop than a reverse-battery protection diode.

## Applications Information

### Automotive Electrical Transients (Load Dump)

- Automotive circuits generally require supply voltage protection from various transient conditions that occur in automotive systems. Several standards define various pulses that can occur. [Table 1](#) summarizes the pulses from the ISO 7637-2 and ISO 16750-2 specification.

Most of the pulses can be mitigated with capacitors and zener clamp diodes (see the [Typical Operating Characteristics](#) and also the [Increasing the Operating Voltage Range](#) section). The load dump (pulse 5a and 5b) occurs when the alternator is charging the battery and a battery terminal gets disconnected. Due to the sudden change in load, the alternator goes out of regulation and the bus voltage spikes. The pulse has a rise time of about 10ms and a fall time of about 400ms but can extend out to 1s or more depending on the characteristics of the charging system. The magnitude of the pulse depends on the bus voltage and whether the system is unsuppressed or uses central load-dump suppression

**Table 1. Summary of ISO 7637-2 Pulses and ISO 16750-2**

NAME	DESCRIPTION	PEAK VOLTAGE (V) (MAX)*	DURATION
		12V SYSTEM	
Pulse 1	Inductive load disconnection	-100	1 to 2ms
Pulse 2a	Inductive wiring disconnection	50	0.05ms
Pulse 3a	Switching transients	-150	0.2μs
Pulse 3b		100	
Pulse 4	Cold crank	-7	100ms (initial)
		-6	Up to 20s
Pulse 5a	Load dump (unsuppressed)	87	400ms (single)
Pulse 5b	Load dump (suppressed)	(Varies, but less than pulse 5a)	

\*Relative to system voltage.

(generally implemented using very large clamp diodes built into the alternator). [Table 1](#) lists the worst-case values from the ISO 7637-2 specification.

Cold crank (pulse 4) occurs when activating the starter motor in cold weather with a marginal battery. Due to the large load imposed by the starter motor, the bus voltage sags. Since the devices can operate down to 3V, the downstream circuitry can continue to operate through a cold-crank condition. If desired, the undervoltage threshold can be increased so that the MOSFETs turn off during a cold crank, disconnecting the downstream circuitry. An output reservoir capacitor can be connected from OUT to GND to provide energy to the circuit during the cold-crank condition.

Refer to the ISO 7637-2 specification for details on pulse waveforms, test conditions, and test fixtures.

### MOSFET Selection

MOSFET selection is critical to design a proper protection circuit. Several factors must be taken into account: the gate capacitance, the drain-to-source voltage rating, the on-resistance ( $R_{DS(ON)}$ ), the peak power-dissipation capability, and the average power-dissipation limit. In general, both MOSFETs should have the same part number. For size-constrained applications, a dual MOSFET can save board area. Select the drain-to-source voltage so that the MOSFETs can handle the highest voltage that might be applied to the circuit. Gate capacitance is not as critical but it does determine the maximum turn-on

and turn-off time. MOSFETs with more gate capacitance tend to respond more slowly.

### MOSFET Power Dissipation

The  $R_{DS(ON)}$  must be low enough to limit the MOSFET power dissipation during normal operation. Power dissipation (per MOSFET) during normal operation can be calculated using this formula:

$$P = I_{LOAD}^2 \times R_{DS(ON)}$$

where P is the power dissipated in each MOSFET and  $I_{LOAD}$  is the average load current.

During a fault condition in switch mode, the MOSFETs turn off and do not dissipate power. Limiter mode imposes the worst-case power dissipation. The average power can be computed using the following formula:

$$P = I_{LOAD} \times (V_{IN} - V_{OUT})$$

where P is the average power dissipated in both MOSFETs,  $I_{LOAD}$  is the average load current,  $V_{IN}$  is the input voltage, and  $V_{OUT}$  is the average limited voltage on the output. In limiter mode, the output voltage is a sawtooth wave with characteristics determined by the  $R_{DS(ON)}$  of the MOSFETs, the output load current, the output capacitance, the gate charge of the MOSFETs, and the GATE charge-pump current.

Since limiter mode can involve high switching currents when the GATE is turning on at the start of a limiting cycle (especially when the output capacitance is high), it is important to ensure the circuit does not violate the peak power rating of the MOSFETs. Check the pulse power ratings in the MOSFET data sheet.

**MOSFET Gate Protection**

To protect the gate of the MOSFETs, connect a zener clamp diode from the gate to the source. The cathode connects to the gate, and the anode connects to the source. Choose the zener clamp voltage to be above 10V and below the MOSFET  $V_{GS}$  maximum rating.

**Increasing the Input Voltage Protection Range**

The devices can tolerate -36V to +90V. To increase the positive input-voltage protection range, connect two back-to-back zener diodes from IN to GND, and connect a resistor in series with IN and the power-supply input to limit the current drawn by the zener diodes (see [Figure 1](#)).

Zener diode D1 clamps positive voltage excursions and D2 clamps negative voltage excursions. Set the zener voltages so the worst-case voltages do not exceed the ratings of the part. Also ensure that the zener diode power ratings are not exceeded. The combination of the series resistor and the zener diodes also help snub pulses on the supply voltage input and can aid in clamping the low-energy ISO 7637-2 pulses.

It is important to compute the peak power dissipation in the series resistor. Most standard surface-mount resistors are not able to withstand the peak power dissipation during certain pulse events. Check the resistor data sheets for pulse-power derating curves. If necessary, connect multiple resistors in parallel or use automotive-rated resistors.

The shutdown input needs a series resistor to limit the current if  $V_{IN}$  exceeds the clamped voltage on IN. A good starting point is 100k $\Omega$ .

**Output Reservoir Capacitor**

The output capacitor can be used as a reservoir capacitor to allow downstream circuitry to “ride out” fault transient conditions. Since the voltage at the output is protected from input-voltage transients, the capacitor voltage rating can be less than the expected maximum input voltage.

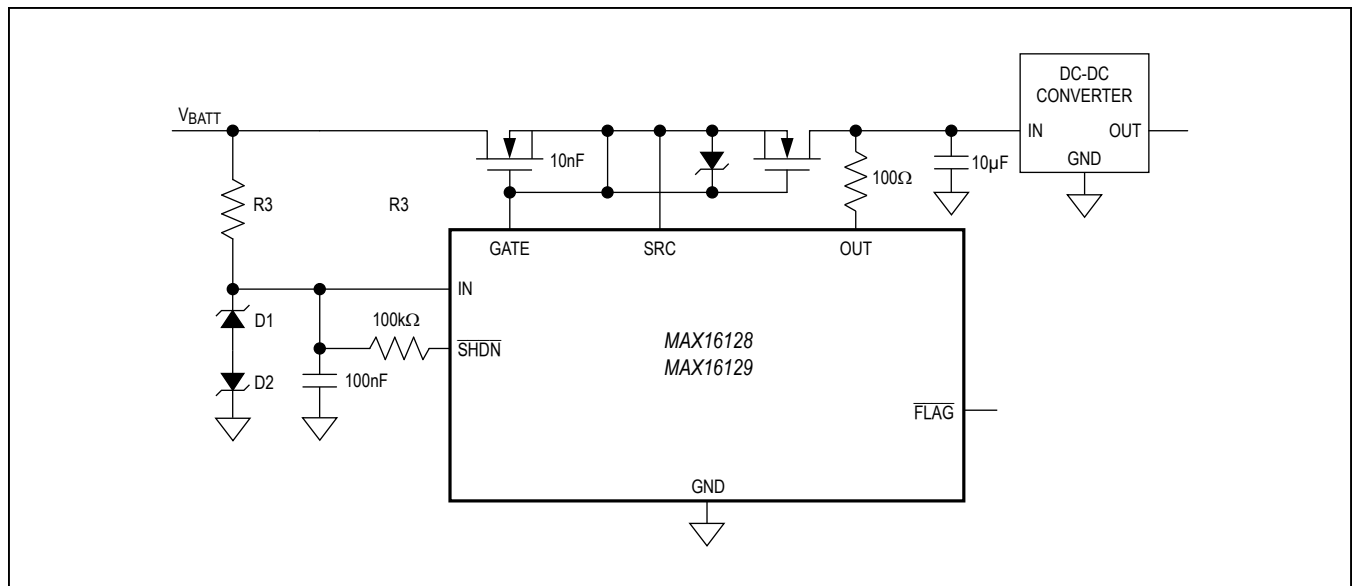

Figure 1. Circuit to Increase Input-Voltage Protection Range

Typical Operating Circuit

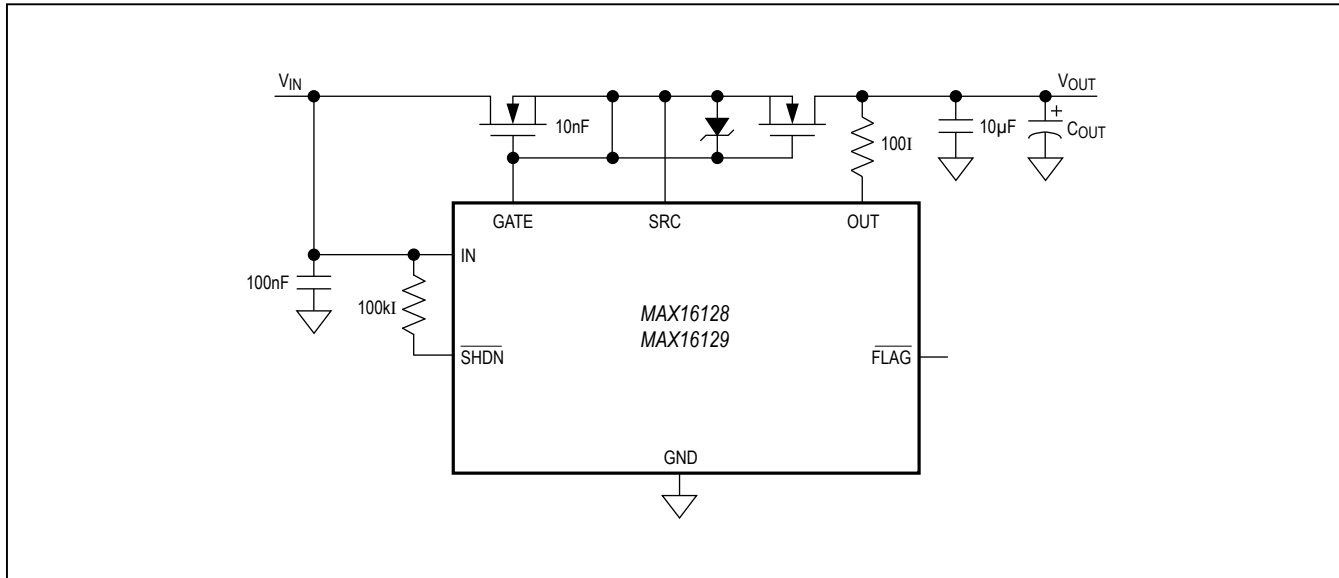

Figure 2. MAX16128/MAX16129 Typical Operating Circuit

Functional Diagram

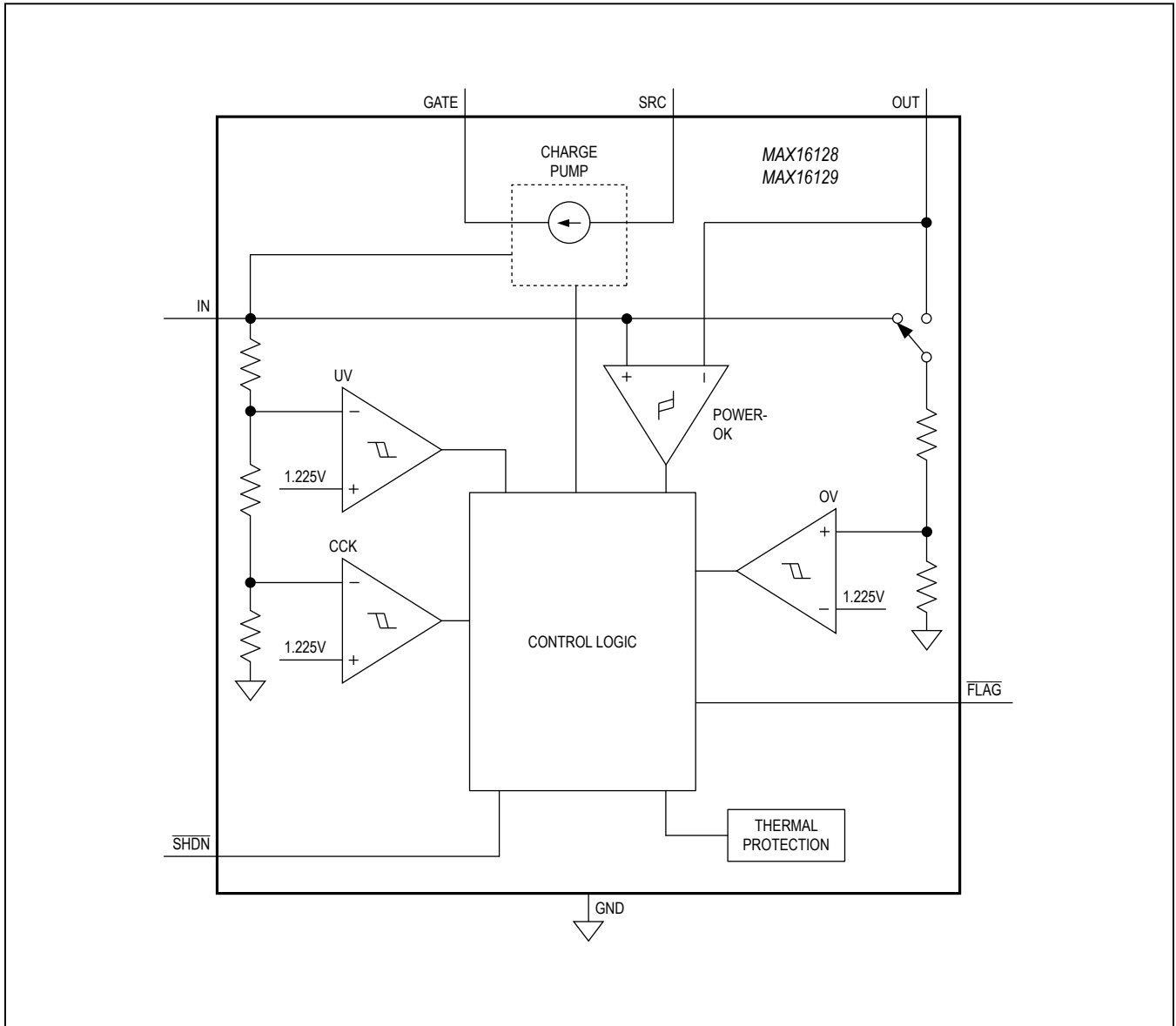

Figure 3. MAX16128/MAX16129 Functional Diagram

**Table 2. UV Threshold (V) (First Suffix)**

PART SUFFIX	UV THRESHOLD (TYP) (V)
A	3
B	5
C	5.98
D	7.03
E	8.13
F	9.09
G	10.3

**Table 3. OV Threshold (V) (Second Suffix)**

PART SUFFIX	OV THRESHOLD (TYP) (V)
A	13.64
B	15
C	18.6
D	20.93
E	24.16
F	28.66
G	31.62

**Table 4. CCK Threshold (Third Suffix)**

PART SUFFIX	CCK THRESHOLD (TYP) (V)
A	No CCK
B	5.64
C	7.65
D	9.67

**Table 5. Switch Mode Option (MAX16128 Only)**

PART SUFFIX	SWITCH MODE
A	Always autoretry
B	One retry, then latch
C	Three retries, then latch
D	Latch mode

### Selector Guide

PART	PIN-PACKAGE	TOP MARK	FUNCTION
MAX16128UAACAC+	8 $\mu$ MAX	+AACE	Switch Mode
MAX16129UAEBD+	8 $\mu$ MAX	+AACG	Limiter Mode

### Ordering Information

PART	TEMP RANGE	PIN-PACKAGE	FUNCTION
MAX16128UA____+	-40°C to +125°C	8 $\mu$ MAX	Switch Mode
MAX16129UA____+	-40°C to +125°C	8 $\mu$ MAX	Limiter Mode

**Note:** The first “\_” is a placeholder for the undervoltage threshold. A desired undervoltage threshold is set by the letter suffix found in [Table 2](#). The second “\_” is a placeholder for the overvoltage threshold. A desired overvoltage threshold is set by the letter suffix found in [Table 3](#). The third “\_” is a placeholder for the CCK threshold set by the letter suffix found in [Table 4](#). For MAX16128 options, the fourth “\_” is a placeholder for the switch-mode option. A desired switch mode is set by the letter suffix found in [Table 5](#).

+Denotes a lead(Pb)-free/RoHS-compliant package.

### Chip Information

PROCESS: BiCMOS

### Package Information

For the latest package outline information and land patterns (footprints), go to [www.maximintegrated.com/packages](http://www.maximintegrated.com/packages). Note that a “+”, “#”, or “-” in the package code indicates RoHS status only. Package drawings may show a different suffix character, but the drawing pertains to the package regardless of RoHS status.

PACKAGE TYPE	PACKAGE CODE	OUTLINE NO.	LAND PATTERN NO.
8 $\mu$ MAX	U8+1	<a href="#">21-0036</a>	<a href="#">90-0092</a>

## Revision History

REVISION NUMBER	REVISION DATE	DESCRIPTION	PAGES CHANGED
0	12/11	Initial release	—
1	9/12	Updated the <i>Features</i> , <i>Electrical Characteristics</i> , <i>Typical Operating Characteristics</i> , <i>Cold-Crank Monitoring</i> , <i>Increasing the Operating Voltage Range</i> sections, and Tables 3 and 4	1–5, 9, 11, 14
2	12/12	Updated Input Supply Current spec in <i>Electrical Characteristics</i> and updated part numbers in <i>Ordering Information</i> and <i>Selector Guide</i>	2, 14
3	12/13	Changed unit in <i>Electrical Characteristics</i> for OUT Input Resistance to Ground from mΩ to MΩ and changed voltage from -6V to -36V in the <i>Reverse-Voltage Protection</i> section	3, 9
4	5/15	Added the <i>Benefits and Features</i> section	1
5	2/17	Updated to reflect IC's fixes	2, 3, 9
6	8/19	Updated <i>Detailed Description</i> , <i>Applications Information</i> , and <i>Typical Operating Circuits</i>	9–12

For pricing, delivery, and ordering information, please visit Maxim Integrated's online storefront at <https://www.maximintegrated.com/en/storefront/storefront.html>.

Maxim Integrated cannot assume responsibility for use of any circuitry other than circuitry entirely embodied in a Maxim Integrated product. No circuit patent licenses are implied. Maxim Integrated reserves the right to change the circuitry and specifications without notice at any time. The parametric values (min and max limits) shown in the *Electrical Characteristics* table are guaranteed. Other parametric values quoted in this data sheet are provided for guidance.

## X-ON Electronics

Largest Supplier of Electrical and Electronic Components

*Click to view similar products for [Supervisory Circuits](#) category:*

*Click to view products by [Maxim](#) manufacturer:*

Other Similar products are found below :

[CAT1161LI-25-G](#) [CAT853STBI-T3](#) [CAT1026LI-30-G](#) [CAT1320LI-25-G](#) [TC54VN2402EMB713](#) [MCP1316T-44NE/OT](#) [MCP1316MT-45GE/OT](#) [MCP1316MT-23LI/OT](#) [MAX8997EWW+](#) [MAX6725AKASYD3-LF-T](#) [DS1232L](#) [NCV302HSN45T1G](#) [PT7M6130NLTA3EX](#) [PT7M7811STBEX-2017](#) [S-1000N28-I4T1U](#) [CAT1161LI-28-G](#) [MCP1321T-29AE/OT](#) [MCP1319MT-47QE/OT](#) [S-1000N23-I4T1U](#) [S-1000N19-I4T1U](#) [CAT824UTDI-GT3](#) [TC54VC2502ECB713](#) [PT7M6133NLTA3EX](#) [PT7M6127NLTA3EX](#) [AP0809ES3-r](#) [HG811RM4/TR](#) [MD7030C](#) [MD7033C](#) [MD7019](#) [MD7020](#) [MD7021](#) [MD7023](#) [MD7024](#) [MD7027](#) [MD7030](#) [MD7033](#) [MD7035](#) [MD7036](#) [MD7039](#) [MD7040](#) [MD7044](#) [MD7050](#) [MD7015](#) [MD7022](#) [MD7028](#) [MD7031](#) [MD7042](#) [MD7043](#) [MD7047](#) [MD7060](#)