

Complete DDR2 and DDR3 Memory Power-Management Solution

General Description

The MAX17000A pulse-width modulation (PWM) controller provides a complete power solution for notebook DDR, DDR2, and DDR3 memory. It comprises a step-down controller, a source-sink LDO regulator, and a reference buffer to generate the required VDDQ, VTT, and VTTR rails.

The VDDQ rail is supplied by a step-down converter using Maxim's proprietary Quick-PWM™ controller. The high-efficiency, constant-on-time PWM controller handles wide input/output voltage ratios (low duty-cycle applications) with ease and provides 100ns response to load transients while maintaining a relatively constant switching frequency. The Quick-PWM architecture circumvents the poor load-transient timing problems of fixed-frequency current-mode PWMs while also avoiding the problems caused by widely varying switching frequencies in conventional constant-on-time and constant-off-time PWM schemes. The controller senses the current to achieve an accurate valley current-limit protection. It is also built in with overvoltage, undervoltage, and thermal protections. The MAX17000A can be set to run in three different modes: power-efficient SKIP mode, low-noise forced-PWM mode, and standby mode to support memory in notebook computer standby operation. The switching frequency is programmable from 200kHz to 600kHz to allow small components and high efficiency. The VDDQ output voltage can be set to a preset 1.8V or 1.5V, or be adjusted from 1.0V to 2.5V by an external resistor-divider. This output has 1% accuracy over line-and-load operating range.

The MAX17000A includes a $\pm 2A$ source-sink LDO regulator for the memory termination VTT rail. This VTT regulator has a $\pm 5mV$ deadband that either sources or sinks, ideal for the fast-changing load burst present in memory termination applications. This feature also reduces output capacitance requirements.

The VTTR reference buffer sources and sinks $\pm 3mA$, providing the reference voltage needed by the memory controller and devices on the memory bus.

The MAX17000A is available in a 24-pin, 4mm x 4mm, thin QFN package.

Applications

- Notebook Computers
- DDR, DDR2, and DDR3 Memory Supplies
- SSTL Memory Supplies

Quick-PWM is a trademark of Maxim Integrated Products, Inc.

Features

- ◆ **SMPS Regulator (VDDQ)**
 Quick-PWM with 100ns Load-Step Response
 Output Voltages—Preset 1.8V, 1.5V, or Adjustable 1.0V to 2.5V
 1% V_{OUT} Accuracy Over Line and Load
 26V Maximum Input Voltage Rating
 Accurate Valley Current-Limit Protection
 200kHz to 600kHz Switching Frequency
- ◆ **Source/Sink Linear Regulator (VTT)**
 $\pm 2A$ Peak Source/Sink
 Low-Output Capacitance Requirement
 Output Voltages—Preset VDDQ/2 or REFIN
 Adjustable from 0.5V to 1.5V
- ◆ **Soft-Start/Soft-Shutdown**
- ◆ **SMPS Power-Good Window Comparator**
- ◆ **VTT Power-Good Window Comparator**
- ◆ **Selectable Overvoltage Protection**
- ◆ **Undervoltage/Thermal Protections**
- ◆ **$\pm 3mA$ Reference Buffer (VTTR)**

Ordering Information

PART	TEMP RANGE	PIN-PACKAGE
MAX17000AETG+	-40°C to +85°C	24 Thin QFN-EP*

+ Denotes a lead(Pb)-free/RoHS-compliant package.

*EP = Exposed pad.

Pin Configuration

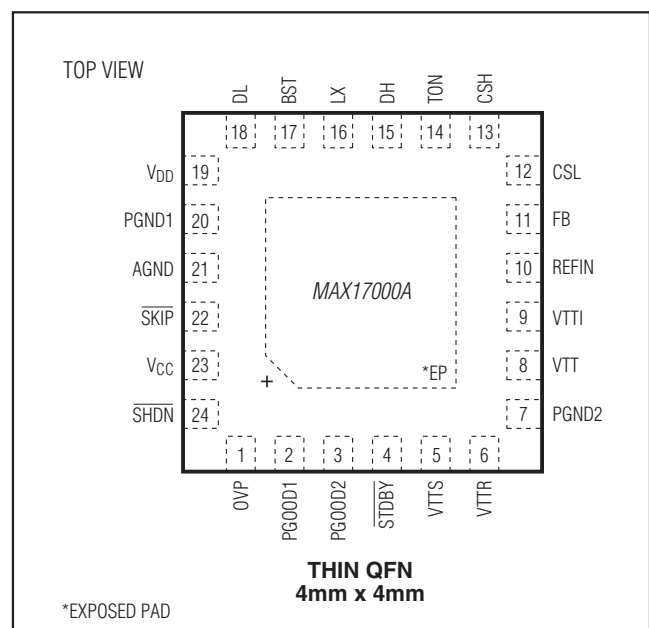

For pricing, delivery, and ordering information, please contact Maxim Direct at 1-888-629-4642, or visit Maxim's website at www.maximintegrated.com.

MAX17000A

Complete DDR2 and DDR3 Memory Power-Management Solution

ABSOLUTE MAXIMUM RATINGS

TON to PGND1	-0.3V to +28V	VTTI to PGND2	-0.3V to +6V
VDD to PGND1	-0.3V to +6V	VTT to PGND2	-0.3V to (VTTI + 0.3V)
VCC to VDD	-0.3V to +0.3V	VTTs to AGND	-0.3V to (VCC + 0.3V)
OVP to AGND	-0.3V to +6V	VTRR to AGND	-0.3V to (VCSL + 0.3V)
SHDN, STDBY, SKIP to AGND	-0.3V to +6V	PGND1, PGND2 to AGND	-0.3V to +0.3V
REFIN, FB, PGOOD1, PGOOD2 to AGND	-0.3V to (VCC + 0.3V)	Continuous Power Dissipation (TA = +70°C)	
CSH, CSL to AGND	-0.3V to (VCC + 0.3V)	24-Pin, 4mm x 4mm Thin QFN	
DL to PGND1	-0.3V to (VDD + 0.3V)	(derated 27.8mW/°C above +70°C)	2222mW
BST to PGND1	-1V to +34V	Operating Temperature Range	-40°C to +85°C
BST to LX	-0.3V to +6V	Junction Temperature	+150°C
DH to LX	-0.3V to (VBST + 0.3V)	Storage Temperature Range	-65°C to +150°C
BST to VDD	-0.3V to +28V	Lead Temperature (soldering, 10s)	+300°C
		Soldering Temperature (reflow)	+260°C

Stresses beyond those listed under "Absolute Maximum Ratings" may cause permanent damage to the device. These are stress ratings only, and functional operation of the device at these or any other conditions beyond those indicated in the operational sections of the specifications is not implied. Exposure to absolute maximum rating conditions for extended periods may affect device reliability.

ELECTRICAL CHARACTERISTICS

(VIN = 12V, VCC = VDD = VSHDN = VREFIN = 5V, VCSL = 1.8V, STDBY = SKIP = AGND, TA = 0°C to +85°C, unless otherwise noted. Typical values are at TA = +25°C.) (Note 1)

PARAMETER	SYMBOL	CONDITIONS	MIN	TYP	MAX	UNITS	
PWM CONTROLLER							
Input Voltage Range	VIN		3		26	V	
	VCC, VDD		4.5		5.5		
Output-Voltage Accuracy	VCSL	VIN = 4.5V to 26V, SKIP = VCC	FB = AGND	1.485	1.500	1.515	V
			FB = VCC	1.782	1.800	1.818	
			FB = Adj	0.99	1.000	1.01	
Output-Voltage Range	VCSL		1		2.7	V	
Load Regulation Error		VCSH - VCSL = 0 to 18mV, SKIP = VCC		0.1		%	
Line Regulation Error		VDD = 4.5V to 5.5V, VIN = 4.5V to 26V		0.25		%	
Soft-Start Ramp Time	tsSTART	Rising edge of SHDN		1.4	2.1	ms	
Soft-Stop Ramp Time	tsSTOP	Falling edge of SHDN		2.8		ms	
Soft-Stop Threshold				25		mV	
On-Time Accuracy (Note 2)	tON	VIN = 12V, VCSL = 1.2V	RTON = 96.75kΩ (600kHz), 167ns nominal	-15		+15	%
			RTON = 200kΩ (300kHz), 333ns nominal	-10		+10	
			RTON = 303.25kΩ (200kHz), 500ns nominal	-15		+15	

MAX17000A

Complete DDR2 and DDR3 Memory Power-Management Solution

ELECTRICAL CHARACTERISTICS (continued)

($V_{IN} = 12V$, $V_{CC} = V_{DD} = \overline{V_{SHDN}} = V_{REFIN} = 5V$, $V_{CSL} = 1.8V$, $\overline{STDBY} = \overline{SKIP} = AGND$, $T_A = 0^{\circ}C$ to $+85^{\circ}C$, unless otherwise noted. Typical values are at $T_A = +25^{\circ}C$.) (Note 1)

PARAMETER	SYMBOL	CONDITIONS	MIN	TYP	MAX	UNITS
Minimum Off-Time	$t_{OFF(MIN)}$	(Note 2)		250	350	ns
Quiescent Supply Current (V_{DD})	I_{DD}	FB forced above 1.0V, $\overline{STDBY} = AGND$ or V_{CC} , $T_A = +25^{\circ}C$		0.01	1.00	μA
Quiescent Supply Current (V_{CC})	I_{CC}	FB forced above 1.0V (PWM, VTT, and VTTR blocks); $\overline{STDBY} = V_{CC}$		2	4	mA
		FB forced above 1.0V (PWM and VTTR blocks); $\overline{STDBY} = AGND$		900	1500	μA
Shutdown Supply Current ($V_{DD} + V_{CC}$)	$I_{CC} + I_{DD}$	$\overline{SHDN} = AGND$, $T_A = +25^{\circ}C$		0.01	5	μA
TON Shutdown Current	I_{TON}	$\overline{SHDN} = AGND$, $V_{IN} = 26V$, $V_{DD} = 0$ or $5V$, $T_A = +25^{\circ}C$		0.01	1.00	μA
LINEAR REGULATOR (VTT)						
VTTI Input Voltage Range	V_{TTI}		1.0		2.8	V
VTTI Supply Current	I_{VTTI}	$V_{TTI} = 2.8V$, $REFIN = 1.4V$, no load		10	50	μA
VTTI Shutdown Current		$\overline{SHDN} = AGND$, $T_A = +25^{\circ}C$			10	μA
REFIN Input Bias Current		$V_{TTI} = 2.8V$, $REFIN = 1.4V$, $T_A = +25^{\circ}C$	-50		+50	nA
REFIN Range	V_{REFIN}		0.5		1.5	V
REFIN Disable Threshold			$V_{CC} - 0.3$			V
VTT Internal MOSFET		High-side on-resistance (source, $I_{VTT} = 0.1A$)		0.12	0.25	Ω
		Low-side on-resistance (sink, $I_{VTT} = 0.1A$)		0.18	0.36	
VTT Output-Accuracy Source Load		($V_{REFIN} - 5mV$) or ($V_{CSL}/2 - 5mV$) to V_{TTS} , $V_{TT} = V_{TTS}$	$V_{REFIN} = 1V$, $I_{VTT} = +50\mu A$	-5	+5	mV
			$V_{REFIN} = 0.5V$ to $1.5V$, $I_{VTT} = +300mA$		-5	
VTT Output-Accuracy Sink Load		($V_{REFIN} + 5mV$) or ($V_{CSL}/2 + 5mV$) to V_{TTS} , $V_{TT} = V_{TTS}$	$V_{REFIN} = 1V$, $I_{VTT} = -50\mu A$	-5	+5	mV
			$V_{REFIN} = 0.5V$ to $1.5V$, $I_{VTT} = -300mA$		+5	
VTT Load Regulation		$-50\mu A$ to $-1A \leq I_{VTT} \leq +50\mu A$ to $+1A$		13	17	mV/A
VTT Line Regulation		$1.0V \leq V_{TTI} \leq 2.8V$, $I_{VTT} = \pm 100mA$		1		mV
VTT Current Limit		Source	2		4	A
		Sink	-4		-2	
VTT Current-Limit Soft-Start Time		With respect to internal VTT_EN signal		160		μs
VTT Discharge MOSFET		$OVP = V_{CC}$		16		Ω
VTTS Input Current		$T_A = +25^{\circ}C$		0.1	1.0	μA

MAX17000A

Complete DDR2 and DDR3 Memory Power-Management Solution

ELECTRICAL CHARACTERISTICS (continued)

($V_{IN} = 12V$, $V_{CC} = V_{DD} = V_{SHDN} = V_{REFIN} = 5V$, $V_{CSL} = 1.8V$, $STDBY = \overline{SKIP} = AGND$, $T_A = 0^{\circ}C$ to $+85^{\circ}C$, unless otherwise noted. Typical values are at $T_A = +25^{\circ}C$.) (Note 1)

PARAMETER	SYMBOL	CONDITIONS	MIN	TYP	MAX	UNITS
REFERENCE BUFFER (VTTR)						
VTTR Output Accuracy (Adj)		REFIN to VTTR	$I_{VT} = \pm 1mA$	-10	+10	mV
			$I_{VT} = \pm 3mA$	-20	+20	
VTTR Output Accuracy (Preset)		$V_{CSL}/2$ to VTTR	$I_{VT} = \pm 1mA$	-10	+10	
			$I_{VT} = \pm 3mA$	-20	+20	
VTTR Maximum Recommended Current		Source/sink		5		mA
FAULT DETECTION (SMPS)						
SMPS OVP and PGOOD1 Upper Trip Threshold			12	15	18	%
SMPS OVP and PGOOD1 Upper Trip Threshold Fault-Propagation Delay	t_{OVP}	FB forced 25mV above trip threshold		10		μs
SMPS Output Undervoltage Fault-Propagation Delay	t_{UVF}			200		μs
SMPS PGOOD1 Lower Trip Threshold		Measured at FB, hysteresis = 25mV	-12	-15	-18	%
PGOOD1 Lower Trip Threshold Propagation Delay	t_{PGOOD1}	FB forced 50mV below PGOOD1 trip threshold		10		μs
PGOOD1 Output Low Voltage		$I_{SINK} = 3mA$			0.4	V
PGOOD1 Leakage Current	I_{PGOOD1}	FB = 1V (PGOOD1 high impedance), PGOOD1 forced to 5V, $T_A = +25^{\circ}C$			1	μA
TON POR Threshold	$V_{POR(IN)}$	Rising edge, PWM disabled below this level; hysteresis = 200mV		3.0		V
FAULT DETECTION (VTT)						
PGOOD2 Upper Trip Threshold		Hysteresis = 25mV	8	10	13	%
PGOOD2 Lower Trip Threshold		Hysteresis = 25mV	-13	-10	-8	%
PGOOD2 Propagation Delay	t_{PGOOD2}	VTTs forced 50mV beyond PGOOD2 trip threshold		10		μs
PGOOD2 Fault Latch Delay		VTTs forced 50mV beyond PGOOD2 trip threshold		5		ms
PGOOD2 Output Low Voltage		$I_{SINK} = 3mA$			0.4	V
PGOOD2 Leakage Current	I_{PGOOD2}	VTTs = V_{REFIN} (PGOOD2 high impedance), PGOOD2 forced to 5V, $T_A = +25^{\circ}C$			1	μA
FAULT DETECTION						
Thermal-Shutdown Threshold	T_{SHDN}	Hysteresis = 15 $^{\circ}C$		160		$^{\circ}C$
V_{CC} Undervoltage Lockout Threshold	$V_{UVLO(VCC)}$	Rising edge, IC disabled below this level; hysteresis = 200mV	3.8	4.1	4.4	V
CSL Discharge MOSFET		OVP = V_{CC}		16		Ω

MAX17000A

Complete DDR2 and DDR3 Memory Power-Management Solution

ELECTRICAL CHARACTERISTICS (continued)

($V_{IN} = 12V$, $V_{CC} = V_{DD} = V_{SHDN} = V_{REFIN} = 5V$, $V_{CSL} = 1.8V$, $\overline{STDBY} = \overline{SKIP} = AGND$, $T_A = 0^{\circ}C$ to $+85^{\circ}C$, unless otherwise noted. Typical values are at $T_A = +25^{\circ}C$.) (Note 1)

PARAMETER	SYMBOL	CONDITIONS	MIN	TYP	MAX	UNITS
CURRENT LIMIT						
Valley Current-Limit Threshold	V_{LIMIT}	$V_{CSH} - V_{CSL}$	17	20	25	mV
Current-Limit Threshold (Negative)	V_{NEG}	$V_{CSH} - V_{CSL}$, $\overline{SKIP} = V_{CC}$		-23		mV
Current-Limit Threshold (Zero Crossing)	V_{ZX}	$V_{PGND1} - V_{LX}$		1		mV
SMPS GATE DRIVERS						
DH Gate-Driver On-Resistance	R_{DH}	BST - LX forced to 5V		1.5	5.0	Ω
DL Gate-Driver On-Resistance	R_{DL}	DL high		1.5	5.0	Ω
		DL low		0.6	3.0	
DH Gate-Driver Source/Sink Current	I_{DH}	DH forced to 2.5V, BST - LX forced to 5V		1		A
DL Gate-Driver Source/Sink Current	$I_{DL(SRC)}$	DL forced to 2.5V		1		A
	$I_{DL(SNK)}$	DL forced to 2.5V		3		
Dead Time	t_{DEAD}	DL rising, $T_A = +25^{\circ}C$	10	25		ns
		DL falling, $T_A = +25^{\circ}C$	15	35		
Internal BST Switch On-Resistance	R_{BST}	$I_{BST} = 10mA$, $V_{DD} = 5V$ internal design target		4.5		Ω
LX, BST Leakage Current		$V_{BST} = V_{LX} = 26V$, $\overline{SHDN} = AGND$, $T_A = +25^{\circ}C$		0.001	20	μA
INPUTS AND OUTPUTS						
Logic-Input Threshold		\overline{SHDN} , \overline{STDBY} , \overline{SKIP} , OVP, rising edge hysteresis = 300mV/600mV (min/max)	1.30	1.65	2.00	V
Logic-Input Current		\overline{SHDN} , \overline{STDBY} , $\overline{SKIP} = 0$ or V_{CC} , $T_A = +25^{\circ}C$	-1		+1	μA
Input Leakage Current		$CSH = 0$ or V_{CC} , $T_A = +25^{\circ}C$	-1		+1	μA
Input Bias Current		$CSL = 0$ or V_{CC}		55	100	μA

MAX17000A

Complete DDR2 and DDR3 Memory Power-Management Solution

ELECTRICAL CHARACTERISTICS

($V_{IN} = 12V$, $V_{CC} = V_{DD} = V_{SHDN} = V_{REFIN} = 5V$, $V_{CSL} = 1.8V$, $\overline{STDBY} = \overline{SKIP} = AGND$, $T_A = -40^{\circ}C$ to $+85^{\circ}C$, unless otherwise noted.) (Note 1)

PARAMETER	SYMBOL	CONDITIONS	MIN	MAX	UNITS	
PWM CONTROLLER						
Input Voltage Range	V_{IN}		3	26	V	
	V_{CC}, V_{DD}		4.5	5.5		
Output-Voltage Accuracy	V_{CSL}	$V_{IN} = 4.5V$ to $26V$, $\overline{SKIP} = V_{CC}$	FB = AGND	1.485	1.520	V
			FB = V_{CC}	1.782	1.820	
			FB = Adj	0.990	1.020	
On-Time Accuracy (Note 2)	t_{ON}	$V_{IN} = 12V$, $V_{CSL} = 1.2V$	$R_{TON} = 96.75k\Omega$ (600kHz), 167ns nominal	-15	+15	%
			$R_{TON} = 200k\Omega$ (300kHz), 333ns nominal	-10	+10	
			$R_{TON} = 303.25k\Omega$ (200kHz), 500ns nominal	-15	+15	
Minimum Off-Time	$t_{OFF(MIN)}$	(Note 2)		350	ns	
Quiescent Supply Current (V_{CC})	I_{CC}	FB forced above 1.0V (PWM, VTT, and VTTR blocks); $\overline{STDBY} = V_{CC}$		4	mA	
		FB forced above 1.0V (PWM and VTTR blocks); $\overline{STDBY} = AGND$		1500	μA	
LINEAR REGULATOR (VTT)						
VTTI Input Voltage Range	V_{VTTI}		1.0	2.8	V	
VTTI Supply Current	I_{VTTI}	VTTI = 2.8V, REFIN = 1.4V, no load		50	μA	
REFIN Range	V_{REFIN}		0.5	1.5	V	
REFIN Disable Threshold			$V_{CC} - 0.3$		V	
VTT Internal MOSFET		High-side on-resistance (source, $I_{VTT} = 0.1A$)		0.25	Ω	
		Low-side on-resistance (sink, $I_{VTT} = 0.1A$)		0.36		
VTT Load Regulation		$-50\mu A$ to $-1A \leq I_{VTT} \leq +50\mu A$ to $+1A$		17	mV/A	

MAX17000A

Complete DDR2 and DDR3 Memory Power-Management Solution

ELECTRICAL CHARACTERISTICS (continued)

($V_{IN} = 12V$, $V_{CC} = V_{DD} = \overline{V_{SHDN}} = V_{REFIN} = 5V$, $V_{CSL} = 1.8V$, $\overline{STDBY} = \overline{SKIP} = AGND$, $T_A = -40^{\circ}C$ to $+85^{\circ}C$, unless otherwise noted.)
(Note 1)

PARAMETER	SYMBOL	CONDITIONS	MIN	MAX	UNITS	
REFERENCE BUFFER (VTTR)						
VTTR Output Accuracy (Adj)		REFIN to VTTR	$I_{VTT} = \pm 1mA$	-10	+10	mV
			$I_{VTT} = \pm 3mA$	-20	+20	
VTTR Output Accuracy (Preset)		$V_{CSL}/2$ to VTTR	$I_{VTT} = \pm 1mA$	-10	+10	mV
			$I_{VTT} = \pm 3mA$	-20	+20	
FAULT DETECTION (SMPS)						
PGOOD1 Output Low Voltage		$I_{SINK} = 3mA$		0.4	V	
FAULT DETECTION (VTT)						
PGOOD2 Output Low Voltage		$I_{SINK} = 3mA$		0.4	V	
FAULT DETECTION						
V _{CC} Undervoltage-Lockout Threshold	$V_{UVLO(VCC)}$	Rising edge, IC disabled below this level; hysteresis = 200mV	4.0	4.4	V	
CURRENT LIMIT						
Valley Current-Limit Threshold	V_{LIMIT}	$V_{CSH} - V_{CSL}$	15	25	mV	
SMPS GATE DRIVERS						
DH Gate-Driver On-Resistance	R_{DH}	BST - LX forced to 5V		5	Ω	
DL Gate-Driver On-Resistance	R_{DL}	DL high		5	Ω	
		DL low		3		
Dead Time	t_{DEAD}	DL rising	10		ns	
		DL falling	15			
INPUTS AND OUTPUTS						
Logic-Input Threshold		\overline{SHDN} , \overline{STDBY} , \overline{SKIP} OVP, rising edge hysteresis = 300mV/600mV (min/max)	1.3	2	V	

Note 1: Limits are 100% production tested at $T_A = +25^{\circ}C$. Maximum and minimum limits over temperature are guaranteed by design and characterization.

Note 2: On-time and off-time specifications are measured from 50% point at the DH pin with LX = GND, $V_{BST} = 5V$, and a 250pF capacitor connected from DH to LX. Actual in-circuit times might differ due to MOSFET switching speeds.

MAX17000A

Complete DDR2 and DDR3 Memory Power-Management Solution

Typical Operating Characteristics

(MAX17000A Circuit of Figure 1, $V_{IN} = 12V$, $V_{DD} = V_{CC} = 5V$, $SKIP = GND$, $T_A = +25^\circ C$, unless otherwise noted.)

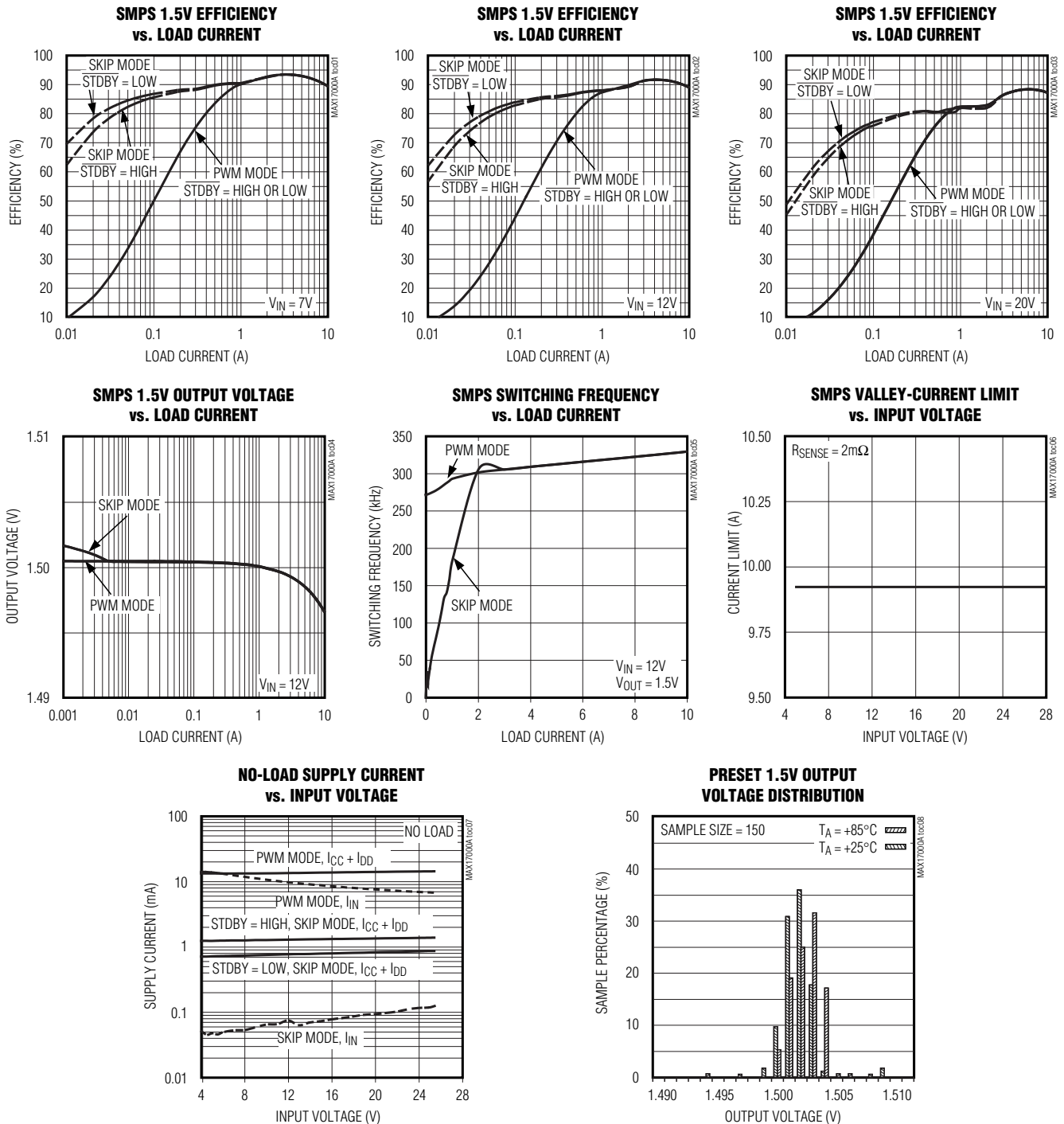

MAX17000A

Complete DDR2 and DDR3 Memory Power-Management Solution

Typical Operating Characteristics (continued)

(MAX17000A Circuit of Figure 1, $V_{IN} = 12V$, $V_{DD} = V_{CC} = 5V$, $SKIP = GND$, $T_A = +25^\circ C$, unless otherwise noted.)

**STARTUP WAVEFORM
(HEAVY LOAD)**

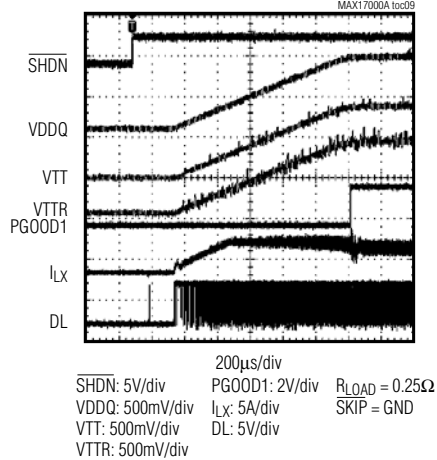

**SHUTDOWN WAVEFORM
(DISCHARGE MODE ENABLED)**

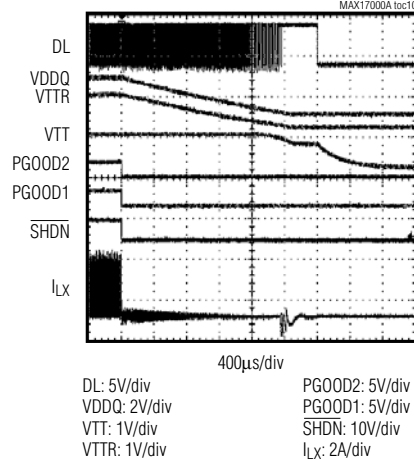

STANDBY TRANSITION WAVEFORM

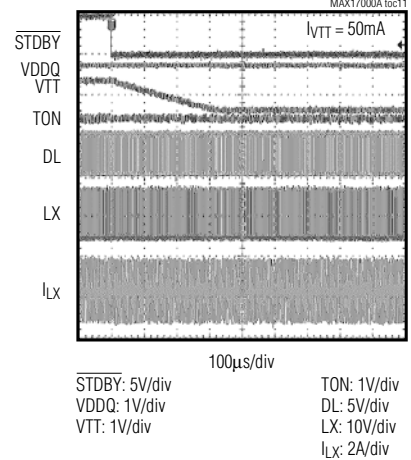

STANDBY TRANSITION WAVEFORM

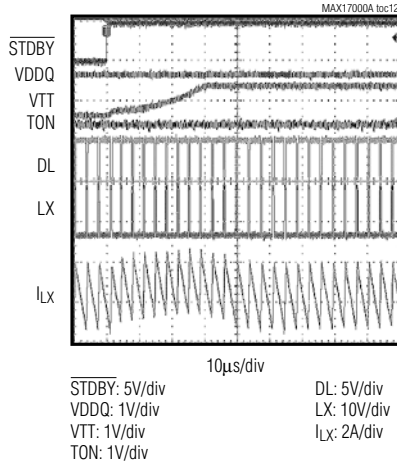

**SMPS LOAD-TRANSIENT RESPONSE
(PWM MODE)**

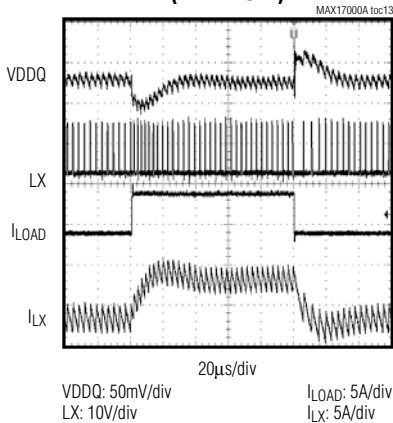

**SMPS LOAD-TRANSIENT RESPONSE
(SKIP MODE)**

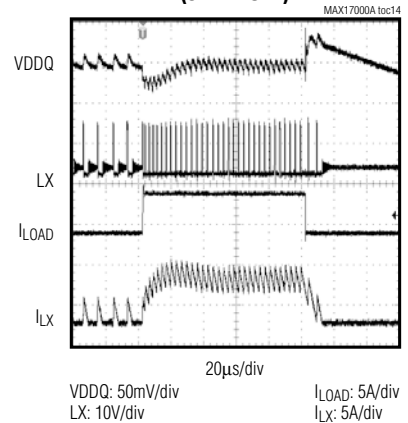

MAX17000A

Complete DDR2 and DDR3 Memory Power-Management Solution

Typical Operating Characteristics (continued)

(MAX17000A Circuit of Figure 1, $V_{IN} = 12V$, $V_{DD} = V_{CC} = 5V$, $SKIP = GND$, $T_A = +25^\circ C$, unless otherwise noted.)

OUTPUT OVERLOAD WAVEFORM

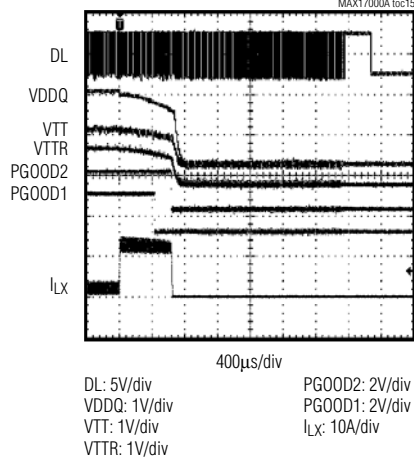

VTT VOLTAGE vs. SOURCE/SINK LOAD CURRENT

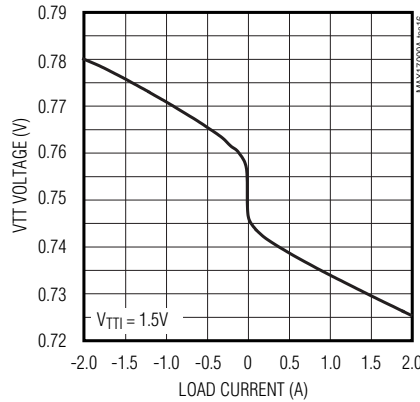

VTT OFFSET VOLTAGE DISTRIBUTION AT 300mA LOAD

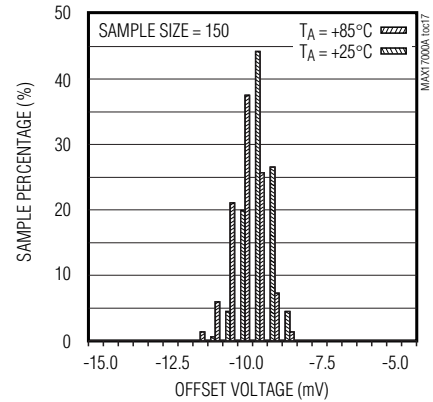

VTT SOURCE CURRENT LIMIT

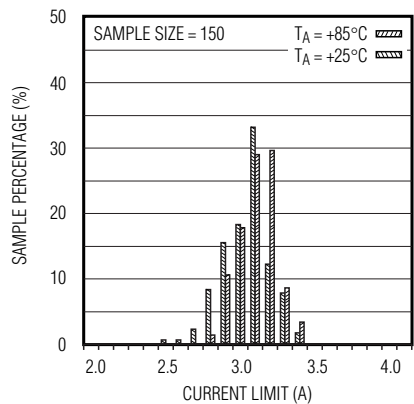

VTT SINK CURRENT LIMIT

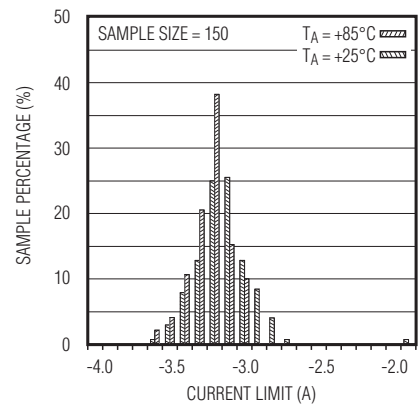

VTT OVERLOAD FAULT WAVEFORMS (5ms TIMER)

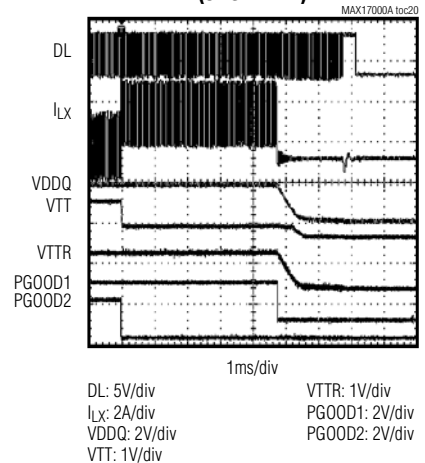

MAX17000A

Complete DDR2 and DDR3 Memory Power-Management Solution

Typical Operating Characteristics (continued)

(MAX17000A Circuit of Figure 1, $V_{IN} = 12V$, $V_{DD} = V_{CC} = 5V$, $SKIP = GND$, $T_A = +25^\circ C$, unless otherwise noted.)

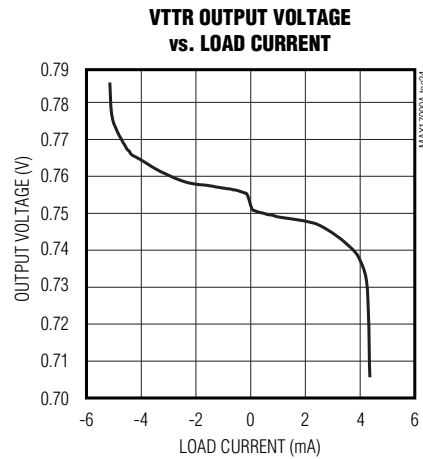
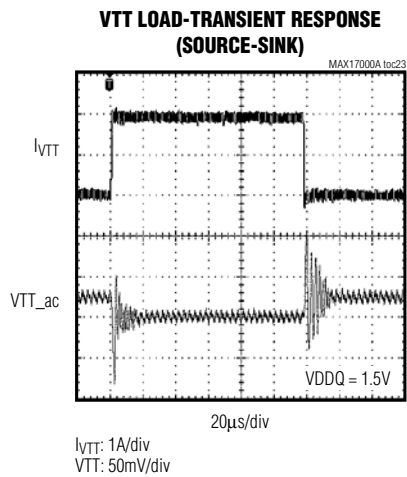
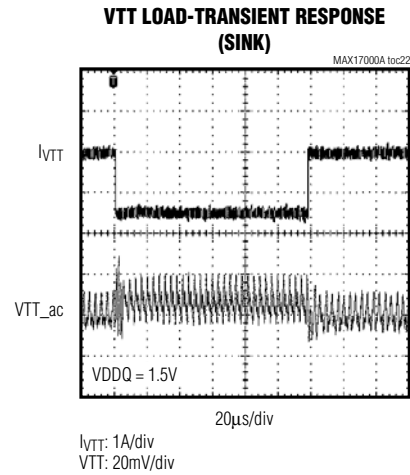
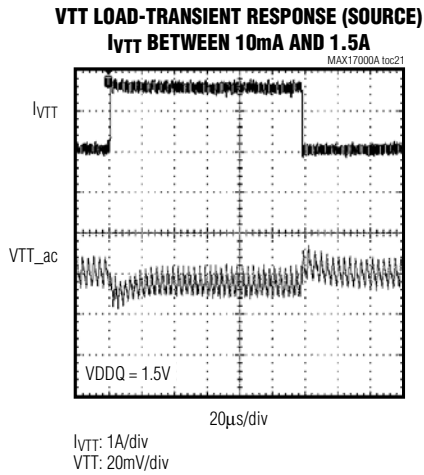

MAX17000A

Complete DDR2 and DDR3 Memory Power-Management Solution

Pin Description

PIN	NAME	FUNCTION
1	OVP	OVP Mode Control. This input selectively enables/disables the SMPS OV protection feature and output discharge mode. When enabled, the SMPS OV protection feature is enabled. Connect OVP to the following voltage levels for the desired function: High (> 2.4V) = Enable SMPS OV protection, and SMPS and VTT discharge FETs. Low (GND) = Disable SMPS OV protection, and SMPS and VTT discharge FETs.
2	PGOOD1	Open-Drain Power-Good Output. PGOOD1 is low when the SMPS output voltage is more than 15% (typ) beyond the normal regulation point, in standby, in shutdown, and during soft-start. After the soft-start circuit has terminated, PGOOD1 becomes high impedance if the SMPS output is in regulation.
3	PGOOD2	Open-Drain Power-Good Output. PGOOD2 is low when the VTT output voltage is more than 10% (typ) beyond the normal regulation point, in standby, in shutdown, and during soft-start. After the SMPS soft-start circuit has terminated, PGOOD2 becomes high impedance if the VTT output is in regulation.
4	$\overline{\text{STDBY}}$	Standby Control Input. When $\overline{\text{SHDN}}$ is high and $\overline{\text{STDBY}}$ is low, the MAX17000A turns off the VTT output (high-Z). When $\overline{\text{STDBY}}$ is high, normal SMPS operation resumes and the VTT output is enabled.
5	VTTs	Sense Pin for Termination Supply Output. Normally connected to the VTT pin to allow accurate regulation to $V_{\text{CSL}/2}$ or the REFIN voltage.
6	VTT _R	Termination Reference Buffer Output. VTT _R tracks $V_{\text{CSL}/2}$ when REFIN is connected to V_{CC} . VTT _R tracks V_{REFIN} when a voltage between 0.5V to 1.5V is set at REFIN. Decouple VTT _R to AGND with a 0.33 μ F ceramic capacitor.
7	PGND2	Power Ground for VTT. Connect PGND2 externally to the underside of the exposed pad.
8	VTT	Termination Power-Supply Output. Connect VTT to VTTs to regulate the VTT voltage to the VTTs regulation setting.
9	VTT _I	Termination Power-Supply Input. VTT _I is the input power supply to the VTT linear regulator. Normally connected to the output of the SMPS regulator for DDR applications.
10	REFIN	External Reference Input. REFIN sets the feedback regulation voltage ($V_{\text{TTR}} = V_{\text{TTS}} = V_{\text{REFIN}}$) of the MAX17000A. Connect REFIN to V_{CC} to use the internal $V_{\text{CSL}/2}$ divider. Connect a 0.5V to 1.5V voltage input to set the adjustable output for VTT, VTTs, and VTT _R .
11	FB	Feedback Input for SMPS Output. Connect to V_{CC} for a fixed +1.8V output or to AGND for a fixed +1.5V output. For an adjustable output (1.0V to 2.7V), connect FB to a resistive divider from the output voltage. FB regulates to +1.0V.
12	CSL	Negative Input of the PWM Output Current-Sense and Supply Input for VTT _R . Connect CSL to the negative side of the output current-sensing resistor or the filtering capacitor if the DC resistance of the output inductor is utilized for current sensing. CSL is also the path for the internal 16 Ω discharge MOSFET when V_{CC} UVLO occurs with OVP enabled.
13	CSH	Positive Input of the PWM Output Current Sense. Connect CSH to the positive side of the output current-sensing resistor or the filtering capacitor if the DC resistance of the output inductor is utilized for current sensing.

MAX17000A

Complete DDR2 and DDR3 Memory Power-Management Solution

Pin Description (continued)

PIN	NAME	FUNCTION
14	TON	Switching Frequency Setting Input. An external resistor between the input power source and this pin sets the switching frequency per phase according to the following equation: $T_{SW} = C_{TON} \times (R_{TON} + 6.5k\Omega)$ where $C_{TON} = 16.26\text{pF}$. TON is high impedance in shutdown.
15	DH	High-Side Gate-Driver Output. Swings from LX to BST. DH is low when in shutdown or UVLO.
16	LX	Inductor Connection. Connect LX to the switched side of the inductor as shown in Figure 1.
17	BST	Boost Flying Capacitor Connection. Connect to an external 0.1 μF , 6V capacitor as shown in Figure 1. The MAX17000A contains an internal boost switch.
18	DL	Synchronous-Rectifier Gate-Driver Output. DL swings from V_{DD} to PGND1.
19	V_{DD}	Supply Voltage Input for the DL Gate Driver and 3.3V Reference/Analog Supply. Connect to the system supply voltage (+4.5V to +5.5V). Bypass V_{DD} to power ground with a 1 μF or greater ceramic capacitor.
20	PGND1	Power Ground. Ground connection for the low-side MOSFET gate driver.
21	AGND	Analog Ground. Connect backside exposed pad to AGND.
22	$\overline{\text{SKIP}}$	Pulse-Skipping Control Input. This input determines the mode of operation under normal steady-state conditions and dynamic output-voltage transitions: High (> 2.4V) = Forced-PWM operation Low (AGND) = Pulse-skipping mode
23	V_{CC}	Controller Supply Voltage. Connect to a 4.5V to 5.5V source. Bypass V_{CC} to AGND with a 1 μF or greater ceramic capacitor.
24	$\overline{\text{SHDN}}$	Shutdown Control Input. Connect to V_{CC} for normal operation. When $\overline{\text{SHDN}}$ is pulled low, the MAX17000A slowly ramps down the output voltage to ground. When the internal target voltage reaches 25mV, the controller forces DL low, and enters the low current (1 μA) shutdown state. When discharge mode is enabled by OVP (OVP = high), the CSL and VTT internal 16 Ω discharge MOSFETs are enabled in shutdown. When discharge mode is disabled by OVP (OVP = low), LX, VTT, and VTTR are high impedance in shutdown. A rising edge on $\overline{\text{SHDN}}$ clears the fault OV protection latch.
—	EP	Exposed Pad. Connect backside exposed pad to AGND.

MAX17000A

Complete DDR2 and DDR3 Memory Power-Management Solution

Standard Application Circuits

The MAX17000A standard application circuit (Figure 1) generates the VDDQ, VTT, and VTTR rails for DDR,

DDR2, or DDR3 in a notebook computer. See Table 1 for component selections. Table 2 lists the component manufacturers. Table 3 is the operating mode truth table.

Table 1. Component Selection for Standard Applications

COMPONENT	V _{OUT} = 1.5V TO 1.8V AT 10A	V _{OUT} = 1.5V TO 1.8V AT 6A
	V _{IN} = 7V TO 20V (300kHz)	V _{IN} = 7V TO 16V (500kHz)
Input Capacitor	(2x) 10μF, 25V Taiyo Yuden TMK432BJ106KM	10μF, 25V Taiyo Yuden TMK432BJ106KM
Output Capacitor	(2x) 330μF, 2.5V, 12mΩ (C2 case) SANYO 2R5TPE330MCC2	(2x) 220μF, 2.5V, 21mΩ (B2 case) SANYO 2R5TPE220MLB
Inductor	1.4μH, 12A, 3.4mΩ (typ) Sumida CDEP105(L)NP-1R4	1.4μH, 12A, 3.4mΩ (typ) Sumida CDEP105(L)NP-1R4
Current-Sensing Resistor	2mΩ, 0.5W (2010) Vishay WSL20102L000FEA	3mΩ, 0.5W (2010) Vishay WSL20103L000FEA
MOSFETs	30V, 20A n-channel MOSFET (high side) Fairchild FDMS8690; 30V, 40A n-channel MOSFET (low side) Fairchild FDMS8660S	30V 20A n-channel MOSFET (high side) Fairchild FDMS8690; 30V 40A n-channel MOSFET (low side) Fairchild FDMS8660S

Table 2. Component Suppliers

SUPPLIER	PHONE	WEBSITE
INDUCTORS		
Dale (Vishay)	402-563-6866 (USA)	www.vishay.com
NEC/TOKIN America, Inc.	510-324-4110 (USA)	www.nec-tokinamerica.com
Panasonic Corp.	65-231-3226 (Singapore), 408-749-9714 (USA)	www.panasonic.com
Sumida Corp.	408-982-9660 (USA)	www.sumida.com
TOKO America, Inc.	858-675-8013 (USA)	www.tokoam.com
CAPACITORS		
AVX Corp.	843-448-9411 (USA)	www.avxcorp.com
KEMET Corp.	408-986-0424 (USA)	www.kemet.com
Panasonic Corp.	65-231-3226 (Singapore), 408-749-9714 (USA)	www.panasonic.com
SANYO Electric Co., Ltd.	81-72-870-6310 (Japan), 619-661-6835 (USA)	www.sanyodevice.com
Taiyo Yuden	03-3667-3408 (Japan), 408-573-4150 (USA)	www.t-yuden.com
TDK Corp.	847-803-6100 (USA), 81-3-5201-7241 (Japan)	www.component.tdk.com
SENSING RESISTORS		
Vishay	402-563-6866 (USA)	www.vishay.com
MOSFET		
Fairchild Semiconductor	800-341-0392 (USA)	www.fairchildsemi.com
DIODES		
Central Semiconductor Corp.	631-435-1110	www.centralsemi.com
Nihon Inter Electronics Corp.	81-3-3343-84-3411 (Japan)	www.niec.co.jp

MAX17000A

Complete DDR2 and DDR3 Memory Power-Management Solution

Table 3. Operating Mode Truth Table

	$\overline{\text{SHDN}}$	$\overline{\text{STDBY}}$	$\overline{\text{SKIP}}$	OPERATION
1	L → H	L → H	X	SMPS output ramps up in skip mode with a 1.4ms (typ) ramp time. PGOOD1 is held low until the SMPS output is in regulation. VTT and VTTR ramp up to the final voltage based on $V_{\text{CSL}/2}$ or V_{REFIN} . PGOOD2 is held low until VTT is in regulation.
2	L → H	L	X	SMPS output ramps up in skip mode with a 1.4ms ramp time. PGOOD1 is held low until the SMPS output is in regulation. VTT remains off throughout since $\overline{\text{STDBY}}$ is low. PGOOD2 stays low throughout. VTTR ramps up to the final voltage based on $V_{\text{CSL}/2}$ or V_{REFIN} .
3	H	L → H	X	Standby mode is exited and the full current capability of the MAX17000A is available. VTT ramps up after the internal SMPS block is ready. VTT ramps to the final voltage based on $V_{\text{CSL}/2}$ or V_{REFIN} . PGOOD2 goes high when VTT is in regulation.
4	H	H	H	SMPS is in forced-PWM mode. VTT and VTTR are enabled. PGOOD1 is high when the SMPS output is in regulation. PGOOD2 is high when VTT is in regulation.
5	H	H	L	SMPS is in skip mode. VTT and VTTR are enabled. PGOOD1 is high when the SMPS output is in regulation. PGOOD2 is high when VTT is in regulation.
6	H	L	H	SMPS is in forced-PWM mode. VTT is off and is in high impedance. PGOOD2 is forced low. VTTR is active and regulates to $V_{\text{CSL}/2}$ or V_{REFIN} .
7	H	L	L	SMPS is in skip mode. VTT is off and is high impedance. PGOOD2 is forced low. VTTR is active and regulates to $V_{\text{CSL}/2}$ or V_{REFIN} .
8	H → L	H	X	Skip mode is exited as the MAX17000A ramps the output down to zero. VTTR tracks $V_{\text{CSL}/2}$ or V_{REFIN} during shutdown. After the SMPS output reaches 25mV, DL goes low.
9	H → L	L	X	Skip mode is exited as the MAX17000A ramps the output down to zero. VTTR tracks $V_{\text{CSL}/2}$ or V_{REFIN} during shutdown. After the SMPS output reaches 25mV, DL goes low. VTT is not enabled throughout soft-shutdown.
10	L	X	X	DL low. Internal 16Ω discharge MOSFETs on CSL and VTT enabled if OVP is high, but disabled if OVP is low.

MAX17000A

Complete DDR2 and DDR3 Memory Power-Management Solution

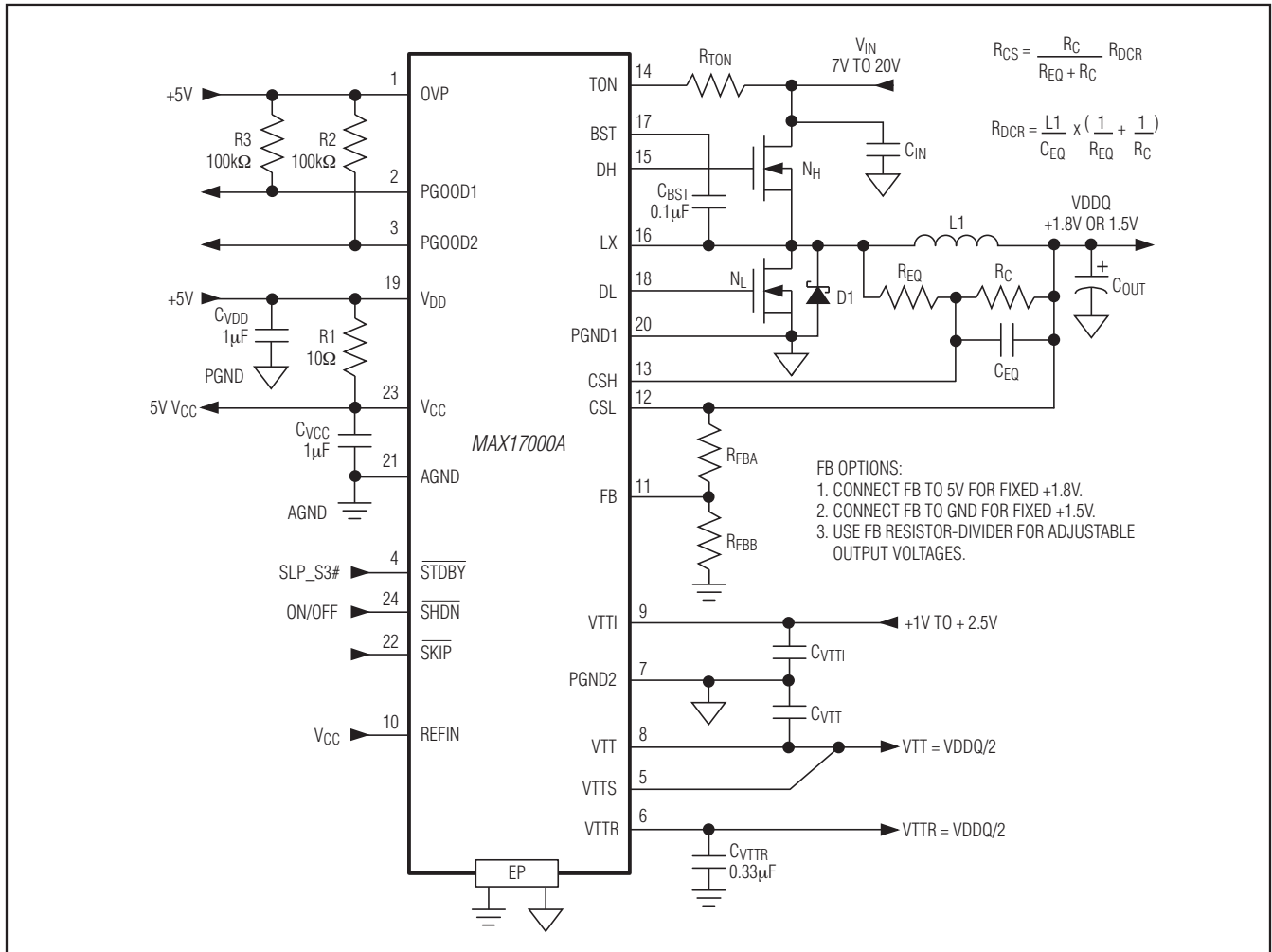

Figure 1. MAX17000A Standard Application Circuit

Detailed Description

The MAX17000A complete DDR solution comprises a step-down controller, a source-sink LDO regulator, and a reference buffer. Maxim's proprietary Quick-PWM pulse-width modulator in the MAX17000A is specifically designed for handling fast load steps while maintaining a relatively constant operating frequency and inductor operating point over a wide range of input voltages. The Quick-PWM architecture circumvents the poor load-transient timing problems of fixed-frequency current-mode PWMs, while also avoiding the problems caused by widely varying switching frequencies in conventional constant-on-time and constant-off-time PWM schemes. Figure 1 is the MAX17000A standard application circuit and Figure 2 is the MAX17000A functional diagram.

The MAX17000A includes a ±2A source-sink LDO regulator for the memory termination rail. The source-sink regulator features a dead band that either sources or sinks, ideal for the fast-changing short-period loads presenting in memory termination applications. This feature also reduces the VTT output capacitance requirement down to 1μF, though load-transient response can still require higher capacitance values between 10μF and 20μF.

The reference buffer sources and sinks ±3mA, generating a reference rail for use in the memory controller and memory devices.

MAX17000A

Complete DDR2 and DDR3 Memory Power-Management Solution

+5V Bias Supply (V_{DD} , V_{CC})

The MAX17000A requires an external 5V bias supply in addition to the battery. Typically, this 5V bias supply is the notebook's 95% efficient 5V system supply. Keeping the bias supply external to the IC improves efficiency and eliminates the cost associated with the 5V linear regulator that would otherwise be needed to supply the PWM circuit and gate drivers. If stand-alone capability is needed, the 5V supply can be generated with an external linear regulator such as the MAX1615.

The 5V bias supply powers both the PWM controller and internal gate-drive power, so the maximum current drawn is:

$$I_{BIAS} = I_Q + f_{SW}Q_G(\text{MOSFETs}) = 2\text{mA to } 20\text{mA (typ)}$$

where I_Q is the current for the PWM control circuit, f_{SW} is the switching frequency, and $Q_G(\text{MOSFETs})$ is the total gate-charge specification limits at $V_{GS} = 5\text{V}$ for the internal MOSFETs.

Free-Running Constant-On-Time PWM Controller with Input Feed-Forward

The Quick-PWM control architecture is a pseudo-fixed-frequency, constant on-time, current-mode regulator with voltage feed-forward. This architecture utilizes the output filter capacitor's ESR to act as a current-sense resistor, so the output ripple voltage can provide the PWM ramp signal. In addition to the general Quick-PWM, the MAX17000A also senses the inductor current through DCR method or with a sensing resistor. Therefore, it is less dependent on the output capacitor ESR for stability. The control algorithm is simple: the high-side switch on-time is determined solely by a one-shot whose pulse width is inversely proportional to input voltage and directly proportional to output voltage. Another one-shot sets a minimum off-time (250ns typ). The on-time one-shot is triggered if the error comparator is low, the low-side switch current is below the valley current-limit threshold, and the minimum off-time one-shot has timed out.

On-Time One-Shot

The heart of the PWM core is the one-shot that sets the high-side switch on-time. This fast, low-jitter, adjustable one-shot includes circuitry that varies the on-time in response to battery and output voltages. The high-side switch on-time is inversely proportional to the battery voltage as measured by the V_{IN} input, and proportional to the output voltage.

An external resistor between the input power source and TON pin sets the switching frequency per phase according to the following equation:

$$t_{ON} = \frac{C_{TON} \times (R_{TON} + 6.5\text{k}\Omega) \times (V_{CSL} + 0.075\text{V})}{V_{IN}}$$
$$f_{SW} = \frac{1}{C_{TON} \times (R_{TON} + 6.5\text{k}\Omega)}$$

where $C_{TON} = 16.26\text{pF}$, and 0.075V is an approximation to accommodate for the expected drop across the low-side MOSFET switch. This algorithm results in a nearly constant switching frequency despite the lack of a fixed-frequency clock generator.

For loads above the critical conduction point, where the dead-time effect is no longer a factor, the actual switching frequency is:

$$f_{SW} = \frac{V_{OUT} + V_{DIS}}{t_{ON} \times (V_{IN} - V_{CHG} + V_{DIS})}$$

where V_{DIS} is the sum of the parasitic voltage drops in the inductor discharge path, including synchronous rectifier, inductor, and PCB resistances; V_{CHG} is the sum of the parasitic voltage drops in the charging path, including the high-side switch, inductor, and PCB resistances; and t_{ON} is the on-time calculated by the MAX17000A.

Automatic Pulse-Skipping Mode (SKIP = AGND)

In skip mode ($\overline{\text{SKIP}} = \text{AGND}$), an inherent automatic switchover to PFM takes place at light loads. This switchover is affected by a comparator that truncates the low-side switch on-time at the inductor current's zero crossing.

DC output-accuracy specifications refer to the threshold of the error comparator. When the inductor is in continuous conduction, the MAX17000A regulates the valley of the output ripple, so the actual DC output voltage is higher than the trip level by 50% of the output ripple voltage. In discontinuous conduction ($\overline{\text{SKIP}} = \text{AGND}$ and $I_{OUT} < I_{LOAD}(\text{SKIP})$), the output voltage has a DC regulation level higher than the error-comparator threshold by approximately 1.5% due to slope compensation. However, the internal integrator corrects for most of it, resulting in very little load regulation.

The MAX17000A always uses skip mode during start-up, regardless of the $\overline{\text{SKIP}}$ and $\overline{\text{STDBY}}$ setting. The $\overline{\text{SKIP}}$ and $\overline{\text{STDBY}}$ controls take effect after soft-start is done. See Figure 3.

MAX17000A

Complete DDR2 and DDR3 Memory Power-Management Solution

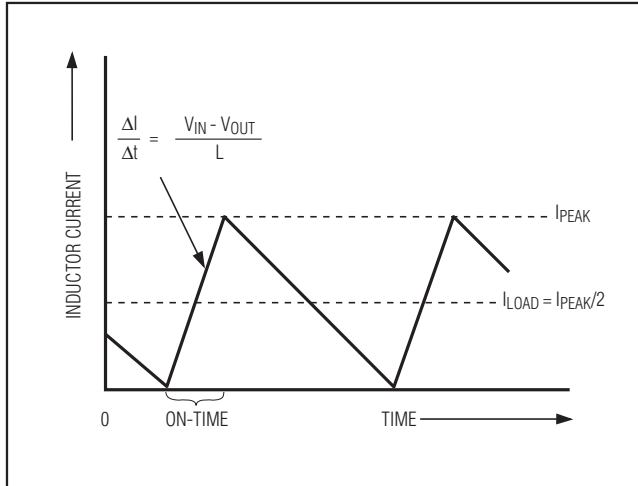

Figure 3. Pulse-Skipping/Discontinuous Crossover Point

Forced-PWM Mode ($\overline{SKIP} = V_{CC}$)

The low-noise forced-PWM mode ($\overline{SKIP} = V_{CC}$) disables the zero-crossing comparator, which controls the low-side switch on-time. This forces the low-side gate-drive waveform to constantly be the complement of the high-side gate-drive waveform, so the inductor current

reverses at light loads while DH maintains a duty factor of V_{OUT}/V_{IN} . The benefit of forced-PWM mode is to keep a fairly constant switching frequency. However, forced-PWM operation comes at a cost: the no-load 5V bias current remains between 2mA to 20mA, depending on the switching frequency.

$\overline{STDBY} = \overline{AGND}$ overrides the \overline{SKIP} pin setting, forcing the MAX17000A into standby.

The MAX17000A switches to forced-PWM mode during shutdown, regardless of the state of \overline{SKIP} and \overline{STDBY} levels.

Standby Mode (\overline{STDBY})

It should be noted that standby mode in the MAX17000A corresponds to computer system standby operation, and is not referring to the MAX17000A shutdown status.

When standby mode is enabled ($\overline{STDBY} = \overline{AGND}$), VTT is disabled (high impedance) but VTTR remains active.

When standby mode is disabled ($\overline{STDBY} = V_{CC}$), the VTT block is enabled and the VTT output capacitor is charged. The VTT soft-start current limit increases linearly from zero to its maximum current limit in 160 μ s (typ), keeping the input VTTI inrush low. See Figure 4.

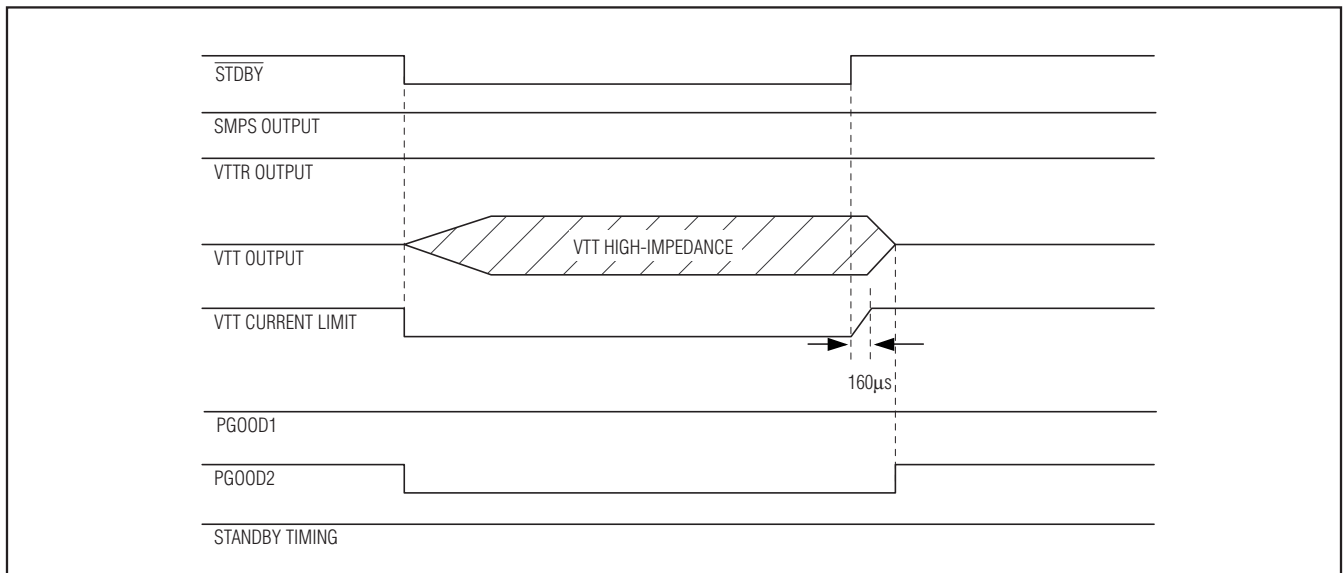

Figure 4. MAX17000A Standby Mode Timing

MAX17000A

Complete DDR2 and DDR3 Memory Power-Management Solution

Valley Current-Limit Protection

The MAX17000A uses the same valley current-limit protection employed on all Maxim Quick-PWM controllers. If the current exceeds the valley current-limit threshold, the PWM controller is not allowed to initiate a new cycle. The actual peak current is greater than the valley current-limit threshold by an amount equal to the inductor ripple current. Therefore, the exact current-limit characteristic and maximum load capability are a function of the inductor value and battery voltage. When combined with the undervoltage-protection circuit, this current-limit method is effective in almost every circumstance.

In forced-PWM mode, the MAX17000A also implements a negative current limit to prevent excessive reverse inductor currents when V_{OUT} is sinking current. The negative current-limit threshold is set to approximately 115% of the positive current limit. See Figure 5.

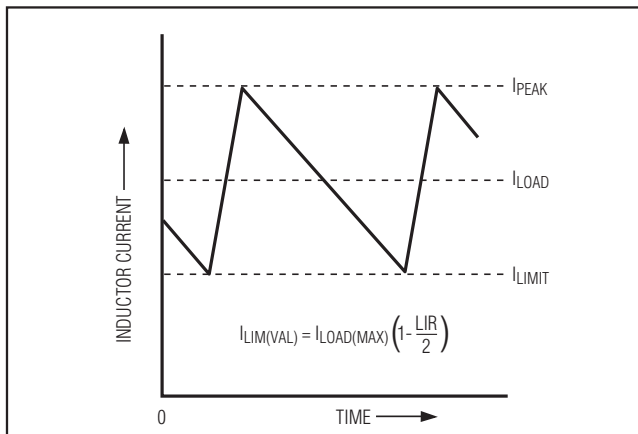

Figure 5. Valley Current-Limit Threshold Point

Power-Good Outputs (PGOOD1 and PGOOD2)

The MAX17000A features two power-good outputs. PGOOD1 is the open-drain output for a window comparator that continuously monitors the SMPS output. PGOOD1 is actively held low in shutdown and during soft-start and soft-shutdown. After the soft-start terminates, PGOOD1 becomes high impedance as long as the SMPS output voltage is between 115% (typ) and 85% (typ) of the regulation voltage. When the SMPS output voltage exceeds the 115%/85% regulation window, the MAX17000A pulls PGOOD1 low. Any fault condition on the SMPS output forces PGOOD1 and PGOOD2 low and latches off until the fault latch is cleared by toggling SHDN or cycling V_{CC} power below 1V. Detection of an OVP event immediately pulls PGOOD1 low, regardless of the OVP state (OVP enabled or disabled).

PGOOD2 is the open-drain output for a window comparator that continuously monitors the VTT output. PGOOD2 is actively held low in standby, shutdown, and during soft-start. PGOOD2 becomes high impedance as long as the VTT output voltage is within $\pm 10\%$ of the regulation voltage. When the VTT output exceeds the $\pm 10\%$ threshold, the MAX17000A pulls PGOOD2 low. If PGOOD2 remains low for 5ms (typ), the MAX17000A latches off with the soft-shutdown sequence.

For logic-level output voltages, connect an external 100k Ω pullup resistor from PGOOD1 and PGOOD2 to V_{DD} .

POR, UVLO

Power-on reset (POR) occurs when V_{CC} rises above approximately 2V, resetting the fault latch and soft-start circuit and preparing the controller for power-up. When OVP protection is enabled, a rising edge on POR turns on the 16 Ω discharge MOSFET on CSL and VTT. When OVP is disabled, the internal 16 Ω discharge MOSFETs on CSL and VTT also remain off.

V_{CC} undervoltage lockout (UVLO) circuitry inhibits switching until V_{CC} reaches 4.1V (typ). When V_{CC} rises above 4.1V, the controller activates the PWM controller and initializes soft-start. When V_{CC} drops below the UVLO threshold (falling edge), the controller stops, DL is pulled low, and the internal 16 Ω discharge MOSFETs on the CSL and VTT outputs are enabled, if OVP is enabled.

Soft-Start and Soft-Shutdown

Soft-start and soft-shutdown for the MAX17000A PWM block is voltage based. Soft-start begins when SHDN is driven high. During soft-start, the PWM output is ramped up from 0V to the final set voltage in 1.4ms. This reduces inrush current and provides a predictable ramp-up time for power sequencing. The MAX17000A always uses skip mode during startup, regardless of the SKIP and STDBY setting. The SKIP and STDBY controls take effect after soft-start is done.

The MAX17000A VTT LDO regulator uses a current-limited soft-start function. When the VTT block is enabled, the internal source and sink current limits are linearly increased from zero to the full-scale limit in 160 μ s. Full-scale current limit is available when the VTT output is in regulation, or after 160 μ s, whichever is earlier. The VTT reference buffer does not have any soft-start control.

MAX17000A

Complete DDR2 and DDR3 Memory Power-Management Solution

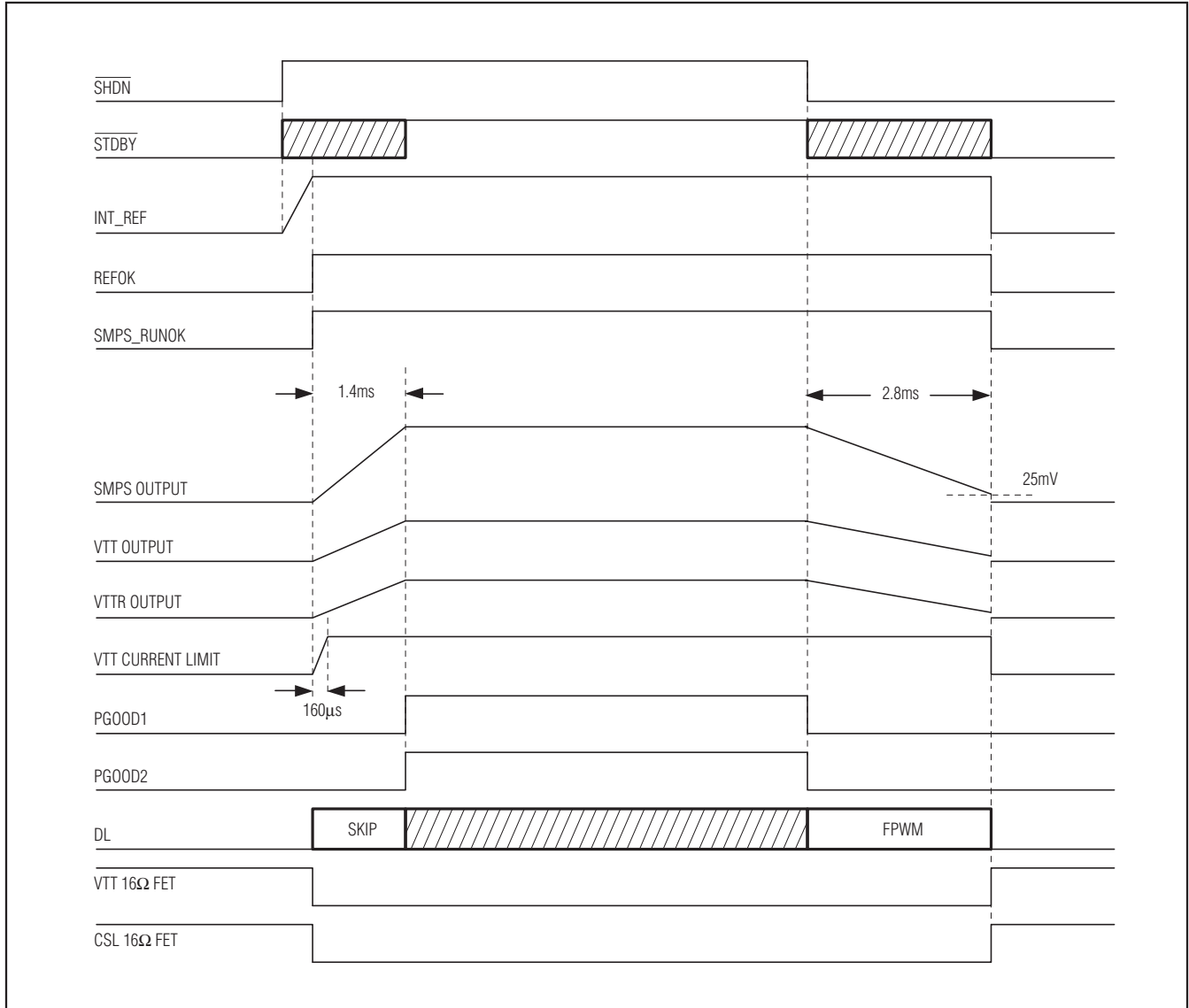

Figure 6. MAX17000A Startup/Shutdown Timing with OVP Enabled

Soft-shutdown begins after $\overline{\text{SHDN}}$ goes low, an output undervoltage fault occurs, or a thermal fault occurs. A fault on the SMPS (UV fault for more than 200μs (typ)), or fault on the VTT output that persists for more than 5ms (typ), triggers shutdown of the whole IC. During soft-shutdown, the output is ramped down to 0V in 2.8ms, reducing negative inductor currents that can cause negative voltages on the output. At the end of soft-shutdown, DL is driven low.

When OVP is enabled ($\text{OVP} = \text{V}_{\text{CC}}$), the internal 16Ω discharging MOSFETs on CSL and VTT are enabled until startup is triggered again by a rising edge of $\overline{\text{SHDN}}$. When OVP is disabled ($\text{OVP} = \text{AGND}$), the CSL and VTT internal 16Ω discharging MOSFETs are not enabled in shutdown.

Output Fault Protection

The MAX17000A provides overvoltage/undervoltage fault protections for the PWM output. Drive OVP to enable and disable fault protection as shown in Table 4.

MAX17000A

Complete DDR2 and DDR3 Memory Power-Management Solution

Table 4. Fault Protection and Shutdown Setting Truth Table

OVP	MODE	REACTION/DRIVER STATE	COMMENT
OVP Disabled Discharge Disabled (OVP = Low)	Shutdown (SHDN = low)	DL immediately pulled low. VTTR tracks the SMPS output during soft-shutdown. CSL and VTT are high impedance at the end of soft-shutdown (16Ω discharge MOSFETs disabled).	Outputs high-impedance in shutdown.
	SMPS UVP	DL immediately pulled low. VTTR tracks the SMPS output during soft-shutdown. CSL and VTT are high impedance at the end of soft-shutdown (16Ω discharge MOSFETs disabled).	SMPS latched fault condition.
	SMPS OVP (disabled)	Controller remains active (normal operation). Note: An OVP detection still pulls PGOOD1 low.	Only PGOOD1 pulled low; fault not latched.
	VTT < -90% or VTT > +110%	PGOOD2 immediately pulled low. Soft-shutdown initiated if fault persists for more than 5ms (typ). DH not used in soft-shutdown. DL low after soft-shutdown completed. VTTR tracks the SMPS output soft-shutdown.	VTT latched fault condition if fault persists for more than 5ms (typ).
	VCC UVLO falling edge	DL and DH immediately pulled low. PGOOD1 and PGOOD2 immediately forced low. VTT and VTTR blocks immediately disabled (high impedance, no 16Ω discharge on outputs).	—
OVP Enabled Discharge Enabled (OVP = High)	Shutdown (SHDN = low)	Soft-shutdown initiated. DL high after soft-shutdown completed. VTTR tracks the SMPS output during soft-shutdown. Internal 16Ω discharge MOSFETs on CSL and VTT enabled after soft-shutdown.	16Ω discharge MOSFETs on CSL and VTT enabled in shutdown.
	SMPS UVP	Soft-shutdown initiated. DH not used in soft-shutdown. DL low after soft-shutdown completed. VTTR tracks the SMPS output during soft-shutdown. Internal 16Ω discharge MOSFETs on CSL and VTT enabled after soft-shutdown.	SMPS latched fault condition.
	SMPS OVP (enabled)	DL immediately latched high, DH forced low. PGOOD1 and PGOOD2 immediately forced low. VTT and VTTR blocks immediately shut down. Internal 16Ω discharge MOSFETs on CSL and VTT enabled.	SMPS latched fault condition.
	VTT < 90% or VTT > 110%	PGOOD2 immediately pulled low. Soft-shutdown initiated if fault persists for more than 5ms (typ). DH not used in soft-shutdown. DL low after soft-shutdown completed. VTTR tracks the SMPS output during soft-shutdown. Internal 16Ω discharge MOSFETs on CSL and VTT enabled after soft-shutdown.	VTT latched fault condition if fault persists for more than 5ms (typ).
OVP Enabled Discharge Enabled (OVP = High)	VCC UVLO falling edge	DL and DH immediately pulled low. PGOOD1 and PGOOD2 immediately forced low. VTT and VTTR blocks immediately disabled. Internal 16Ω discharge MOSFETs on CSL and VTT enabled immediately.	—

Complete DDR2 and DDR3 Memory Power-Management Solution

Table 4. Fault Protection and Shutdown Setting Truth Table (continued)

OVP	MODE	REACTION/DRIVER STATE	COMMENT
General Shutdown and Fault Conditions	Thermal fault	DL and DH immediately pulled low. PGOOD1 and PGOOD2 immediately forced low. VTT and VTTR blocks immediately disabled (high impedance, no 16Ω discharge on outputs).	Active-fault condition.
	V _{CC} UVLO rising edge	Activate INT_REF once V _{CC} rises above UVLO, and $\overline{\text{SHDN}}$ = high. Once REFOK is valid (high), initiate the soft-start sequence. DL remains low until switching/soft-start begins.	—
	V _{CC} POR rising edge	DL forced low.	—
	V _{CC} POR falling edge	DL = Don't care. V _{CC} less than 2VT is not sufficient to turn on the MOSFETs.	—

SMPS Overvoltage Protection (OVP)

If the output voltage of the SMPS rises 115% above its nominal regulation voltage while OVP is enabled (OVP = V_{CC}), the controller sets its overvoltage fault latch, pulls PGOOD1 and PGOOD2 low, and forces DL high. The VTT and VTTR block shut down immediately, and the internal 16Ω discharge MOSFETs on CSL and VTT are turned on. If the condition that caused the overvoltage persists (such as a shorted high-side MOSFET), the battery fuse blows. Cycle V_{CC} below 1V or toggle $\overline{\text{SHDN}}$ to clear the overvoltage fault latch and restart the controller.

OVP is disabled when OVP is connected to AGND (Table 4). PGOOD1 upper threshold remains active at 115% of nominal regulation voltage even when OVP is disabled and the 16Ω discharge MOSFETs on CSL and VTT are not enabled in shutdown.

SMPS Undervoltage Protection (UVP)

If the output voltage of the SMPS falls below 85% of its regulation voltage for more than 200μs (typ), the controller sets its undervoltage fault latch, pulls PGOOD1 and PGOOD2 low, and begins soft-shutdown pulsing DL. DH remains off during the soft-shutdown sequence initiated by an undervoltage fault. After soft-shutdown has completed, the MAX17000A forces DL and DH low, and enables the internal 16Ω discharge MOSFETs on CSL and VTT. Cycle V_{CC} below 1V or toggle $\overline{\text{SHDN}}$ to clear the undervoltage fault latch and restart the controller.

VTT Overvoltage and Undervoltage Protection

If the output voltage of the VTT regulator exceeds ±10% of its regulation voltage for more than 5ms (typ), the controller sets its fault latch, pulls PGOOD1 and PGOOD2 low, and begins soft-shutdown pulsing DL. DH remains off during the soft-shutdown sequence initiated by an undervoltage fault. After soft-shutdown has

completed, the MAX17000A forces DL and DH low, and enables the internal 16Ω discharge MOSFETs on CSL and VTT. Cycle V_{CC} below 1V or toggle $\overline{\text{SHDN}}$ to clear the undervoltage fault latch and restart the controller.

Thermal-Fault Protection

The MAX17000A features a thermal-fault protection circuit. When the junction temperature rises above +160°C, a thermal sensor activates the fault latch, pulls PGOOD1 and PGOOD2 low, and shuts down using the shutdown sequence. Toggle $\overline{\text{SHDN}}$ or cycle V_{CC} power below V_{CC} POR to reactivate the controller after the junction temperature cools by 15°C.

Design Procedure

Firmly establish the input voltage range and maximum load current before choosing a switching frequency and inductor operating point (ripple-current ratio). The primary design trade-off lies in choosing a good switching frequency and inductor operating point, and the following four factors dictate the rest of the design:

- **Input Voltage Range:** The maximum value (V_{IN(MAX)}) must accommodate the worst-case input supply voltage allowed by the notebook's AC adapter voltage. The minimum value (V_{IN(MIN)}) must account for the lowest input voltage after drops due to connectors, fuses, and battery selector switches. If there is a choice at all, lower input voltages result in better efficiency.
- **Maximum Load Current:** There are two values to consider. The peak load current (I_{LOAD(MAX)}) determines the instantaneous component stresses and filtering requirements, and thus drives output capacitor selection, inductor saturation rating, and the design of the current-limit circuit. The continuous load current (I_{LOAD}) determines the thermal

MAX17000A

Complete DDR2 and DDR3 Memory Power-Management Solution

stresses and thus drives the selection of input capacitors, MOSFETs, and other critical heat-contributing components. Most notebook loads generally exhibit $I_{LOAD} = I_{LOAD(MAX)} \times 80\%$.

- Switching Frequency:** This choice determines the basic trade-off between size and efficiency. The optimal frequency is largely a function of maximum input voltage, due to MOSFET switching losses that are proportional to frequency and V_{IN}^2 . The optimum frequency is also a moving target, due to rapid improvements in MOSFET technology that are making higher frequencies more practical.
- Inductor Operating Point:** This choice provides trade-offs between size vs. efficiency and transient response vs. output noise. Low inductor values provide better transient response and smaller physical size, but also result in lower efficiency and higher output noise due to increased ripple current. The minimum practical inductor value is one that causes the circuit to operate at the edge of critical conduction (where the inductor current just touches zero with every cycle at maximum load). Inductor values lower than this grant no further size-reduction benefit. The optimum operating point is usually found between 20% and 50% ripple current.

Inductor Selection

The switching frequency and operating point (% ripple current or LIR) determine the inductor value as follows:

$$L = \left(\frac{V_{IN} - V_{OUT}}{f_{SW} \times I_{LOAD(MAX)} \times LIR} \right) \times \left(\frac{V_{OUT}}{V_{IN}} \right)$$

Find a low-loss inductor having the lowest possible DC resistance that fits in the allotted dimensions. Ferrite cores are often the best choice, although powdered

iron is inexpensive and can work well at 200kHz. The core must be large enough not to saturate at the peak inductor current (I_{PEAK}):

$$I_{PEAK} = I_{LOAD(MAX)} \times \left(1 + \frac{LIR}{2} \right)$$

Setting the Valley Current Limit

The minimum current-limit threshold must be high enough to support the maximum load current when the current limit is at the minimum tolerance value. The valley of the inductor current occurs at $I_{LOAD(MAX)}$ minus half the ripple current; therefore:

$$I_{LIMIT(LOW)} > I_{LOAD(MAX)} \times \left(1 - \frac{LIR}{2} \right)$$

where $I_{LIMIT(LOW)}$ equals the minimum current-limit threshold voltage divided by the output sense element (inductor DCR or sense resistor).

The valley current limit is fixed at 17mV (min) across the CSH to CSL differential input.

Special attention must be made to the tolerance and thermal variation of the on-resistance in the case of DCR sensing. Use the worst-case maximum value for R_{DCR} from the inductor data sheet, and add some margin for the rise in R_{DCR} with temperature. A good general rule is to allow 0.5% additional resistance for each degree Celsius of temperature rise, which must be included in the design margin unless the design includes an NTC thermistor in the DCR network to thermally compensate the current-limit threshold.

The current-sense method (Figure 7) and magnitude determine the achievable current-limit accuracy and power loss. The sense resistor can be determined by:

$$R_{SENSE} = V_{LIMIT}/I_{LIMIT}$$

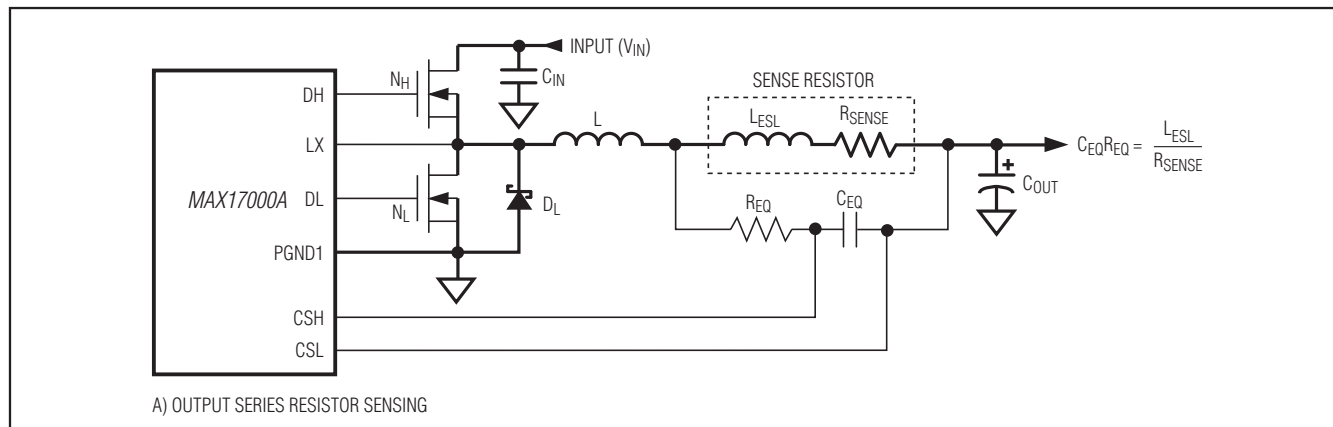

Figure 7a. Current-Sense Configurations (Sheet 1 of 2)

MAX17000A

Complete DDR2 and DDR3 Memory Power-Management Solution

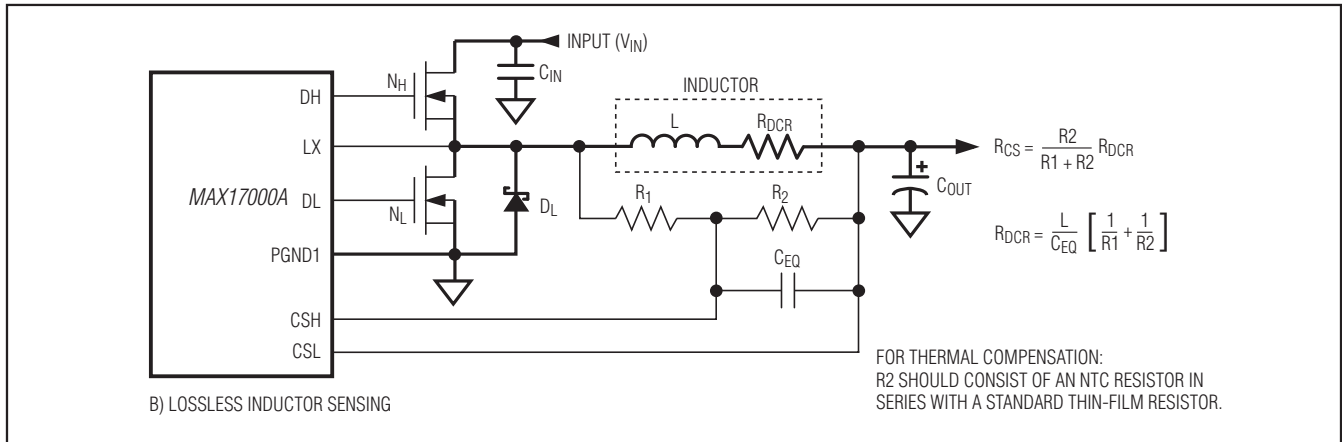

Figure 7b. Current-Sense Configurations (Sheet 2 of 2)

For the best current-sense accuracy and overcurrent protection, use a 1% tolerance current-sense resistor between the inductor and output as shown in Figure 7a. This configuration constantly monitors the inductor current, allowing accurate current-limit protection. However, the parasitic inductance of the current-sense resistor can cause current-limit inaccuracies, especially when using low-value inductors and current-sense resistors. This parasitic inductance (L_{ESL}) can be cancelled by adding an RC circuit across the sense resistor with an equivalent time constant:

$$C_{EQ} \times R_{EQ} = \frac{L_{ESL}}{R_{SENSE}}$$

Alternatively, low-cost applications that do not require highly accurate current-limit protection could reduce the overall power dissipation by connecting a series RC circuit across the inductor (Figure 7b) with an equivalent time constant:

$$R_{CS} = \frac{R2}{R1 + R2} \times R_{DCR}$$

and:

$$R_{DCR} = \frac{L}{C_{EQ}} \times \left[\frac{1}{R1} + \frac{1}{R2} \right]$$

where R_{CS} is the required current-sense resistance, and R_{DCR} is the inductor's series DC resistance. Use the worst-case inductance and R_{DCR} values provided by the inductor manufacturer, adding some margin for the inductance drop over temperature and load.

MOSFET Gate Drivers (DH, DL)

The DH and DL drivers are optimized for driving moderate-sized high-side, and larger low-side power MOSFETs. This is consistent with the low duty factor seen in notebook applications, where a large $V_{IN} - V_{OUT}$ differential exists. The high-side gate driver (DH) sources and sinks 1.2A, and the low-side gate driver (DL) sources 1.0A and sinks 2.4A. This ensures robust gate drive for high-current applications. The DH floating high-side MOSFET driver is powered by an internal boost switch charge pump at BST, while the DL synchronous-rectifier driver is powered directly by the 5V bias supply (V_{DD}).

PWM Output Capacitor Selection

The output filter capacitor must have low enough effective series resistance (ESR) to meet output ripple and load-transient requirements, yet have high enough ESR to satisfy stability requirements.

In core and chipset converters and other applications where the output is subject to large-load transients, the output capacitor's size typically depends on how much ESR is needed to prevent the output from dipping too low under a load transient. Ignoring the sag due to finite capacitance:

$$(R_{ESR} + R_{PCB}) \leq \frac{V_{STEP}}{\Delta I_{LOAD(MAX)}}$$

In low-power applications, the output capacitor's size often depends on how much ESR is needed to maintain an acceptable level of output ripple voltage. The output ripple voltage of a step-down controller equals the total inductor ripple current multiplied by the output capacitor's ESR.

MAX17000A

Complete DDR2 and DDR3 Memory Power-Management Solution

The maximum ESR to meet ripple requirements is:

$$R_{ESR} \leq \left[\frac{V_{IN} \times f_{SW} \times L}{(V_{IN} - V_{OUT}) \times V_{OUT}} \right] \times V_{RIPPLE}$$

where f_{SW} is the switching frequency.

With most chemistries (polymer, tantalum, aluminum, electrolytic), the actual capacitance value required relates to the physical size needed to achieve low ESR and the chemistry limits of the selected capacitor technology. Ceramic capacitors provide low ESR, but the capacitance and voltage rating (after derating) are determined by the capacity needed to prevent V_{SAG} and V_{SOAR} from causing problems during load transients. Generally, once enough capacitance is added to meet the overshoot requirement, undershoot at the rising load edge is no longer a problem. Thus, the output capacitor selection requires carefully balancing capacitor chemistry limitations (capacitance vs. ESR vs. voltage rating) and cost.

PWM Output Capacitor Stability Considerations

For Quick-PWM controllers, stability is determined by the in-phase feedback ripple relative to the switching frequency, which is typically dominated by the output ESR. The boundary of instability is given by the following equation:

$$\frac{f_{SW}}{\pi} \geq \frac{1}{2\pi \times R_{EFF} \times C_{OUT}}$$
$$R_{EFF} = R_{ESR} + A_{CS} \times R_{SENSE}$$

where C_{OUT} is the total output capacitance, R_{ESR} is the total equivalent series resistance of the output capacitors, R_{SENSE} is the effective current-sense resistance (see Figure 7), and A_{CS} is the current-sense gain of 2.

For a standard 300kHz application, the effective zero frequency must be well below 95kHz, preferably below 50kHz. With these frequency requirements, standard tantalum and polymer capacitors already commonly used have typical ESR zero frequencies below 50kHz, allowing the stability requirements to be achieved without any additional current-sense compensation. In the standard application circuit (Figure 1), the ESR needed to support a 15mV_{P-P} ripple is 15mV/(10A × 0.3) = 5mΩ. Two 330μF, 9mΩ polymer capacitors in parallel provide 4.5mΩ (max) ESR and 1/(2π × 330μF × 9mΩ) = 53kHz ESR zero frequency.

Ceramic capacitors have a high-ESR zero frequency, but applications with sufficient current-sense compensation can still take advantage of the small size, low ESR, and high reliability of the ceramic chemistry. By the inductor current DCR sensing, applications with

ceramic output capacitors can be compensated using either a DC-compensation or AC-compensation method. The DC-coupling requires fewer external compensation capacitors, but this also creates an output load line that depends on the inductor's DCR (parasitic resistance). Alternatively, the current-sense information can be AC-coupled, allowing stability to be dependent only on the inductance value and compensation components and eliminating the DC load line.

When only using ceramic output capacitors, output overshoot (V_{SOAR}) typically determines the minimum output capacitance requirement. Their relatively low capacitance value can allow significant output overshoot when stepping from full-load to no-load conditions, unless a small inductor value and high switching frequency are used to minimize the energy transferred from inductor to capacitor during load-step recovery.

Unstable operation manifests itself in two related, but distinctly different ways: double pulsing and feedback loop instability. Double pulsing occurs due to noise on the output or because the ESR is so low that there is not enough voltage ramp in the output voltage signal. This "fools" the error comparator into triggering a new cycle immediately after the minimum off-time period has expired. Double pulsing is more annoying than harmful, resulting in nothing worse than increased output ripple. However, it can indicate the possible presence of loop instability due to insufficient ESR. Loop instability can result in oscillations at the output after line or load steps. Such perturbations are usually damped, but can cause the output voltage to rise above or fall below the tolerance limits.

The easiest method for checking stability is to apply a very fast zero-to-max load transient and carefully observe the output voltage ripple envelope for overshoot and ringing. It can help to simultaneously monitor the inductor current with an AC current probe. Do not allow more than one cycle of ringing after the initial step-response undervoltage/overshoot.

Input Capacitor Selection

The input capacitor must meet the ripple current requirement (I_{RMS}) imposed by the switching currents. The I_{RMS} requirements can be determined by the following equation:

$$I_{RMS} = \left(\frac{I_{LOAD}}{V_{IN}} \right) \sqrt{V_{OUT} \times (V_{IN} - V_{OUT})}$$

The worst-case RMS current requirement occurs when operating with $V_{IN} = 2V_{OUT}$. At this point, the above equation simplifies to:

$$I_{RMS} = 0.5 \times I_{LOAD}$$

Complete DDR2 and DDR3 Memory Power-Management Solution

For most applications, nontantalum chemistries (ceramic, aluminum, or OS-CON) are preferred due to their resistance to inrush surge currents typical of systems with a mechanical switch or connector in series with the input. If the Quick-PWM controller is operated as the second stage of a two-stage power-conversion system, tantalum input capacitors are acceptable. In either configuration, choose an input capacitor that exhibits less than +10°C temperature rise at the RMS input current for optimal circuit longevity.

MOSFET Selection

Most of the following MOSFET guidelines focus on the challenge of obtaining high load-current capability when using high-voltage (> 20V) AC adapters. Low-current applications usually require less attention.

The high-side MOSFET (N_H) must be able to dissipate the resistive losses plus the switching losses at both V_{IN(MIN)} and V_{IN(MAX)}. Calculate both these sums. Ideally, the losses at V_{IN(MIN)} should be roughly equal to losses at V_{IN(MAX)}, with lower losses in between. If the losses at V_{IN(MIN)} are significantly higher than the losses at V_{IN(MAX)}, consider increasing the size of N_H (reducing R_{DS(ON)} but with higher C_{GATE}). Conversely, if the losses at V_{IN(MAX)} are significantly higher than the losses at V_{IN(MIN)}, consider reducing the size of N_H (increasing R_{DS(ON)} to lower C_{GATE}). If V_{IN} does not vary over a wide range, the minimum power dissipation occurs where the resistive losses equal the switching losses.

Choose a low-side MOSFET that has the lowest possible on-resistance (R_{DS(ON)}), comes in a moderate-sized package (i.e., one or two 8-pin SOs, DPAK, or D²PAK), and is reasonably priced. Make sure that the DL gate driver can supply sufficient current to support the gate charge and the current injected into the parasitic gate-to-drain capacitor caused by the high-side MOSFET turning on; otherwise, cross-conduction problems can occur (see the *MOSFET Gate Drivers (DH, DL)* section).

MOSFET Power Dissipation

Worst-case conduction losses occur at the duty factor extremes. For the high-side MOSFET (N_H), the worst-case power dissipation due to resistance occurs at the minimum input voltage:

$$PD(NH\text{ Resistive}) = \left(\frac{V_{OUT}}{V_{IN}} \right) \times (I_{LOAD})^2 \times R_{DS(ON)}$$

Generally, a small high-side MOSFET is desired to reduce switching losses at high input voltages. However, the R_{DS(ON)} required to stay within package power dissipation often limits how small the MOSFET

can be. Again, the optimum occurs when the switching losses equal the conduction (R_{DS(ON)}) losses. High-side switching losses do not usually become an issue until the input is greater than approximately 15V.

Calculating the power dissipation in high-side MOSFET (N_H) due to switching losses is difficult since it must allow for difficult quantifying factors that influence the turn-on and turn-off times. These factors include the internal gate resistance, gate charge, threshold voltage, source inductance, and PCB layout characteristics. The following switching-loss calculation provides only a very rough estimate and is no substitute for breadboard evaluation, preferably including verification using a thermocouple mounted on N_H:

$$PD(NH\text{ Switching}) = V_{IN(MAX)} \times I_{LOAD} \times f_{SW} \left(\frac{Q_{G(SW)}}{I_{GATE}} \right) + \frac{C_{OSS} \times V_{IN}^2 \times f_{SW}}{2}$$

where C_{OSS} is the N_H MOSFET's output capacitance, Q_{G(SW)} is the charge needed to turn on the N_H MOSFET, and I_{GATE} is the peak gate-drive source/sink current (2.2A typ).

Switching losses in the high-side MOSFET can become an insidious heat problem when maximum AC adapter voltages are applied, due to the squared term in the C × V_{IN}² × f_{SW} switching-loss equation. If the high-side MOSFET chosen for adequate R_{DS(ON)} at low battery voltages becomes extraordinarily hot when biased from V_{IN(MAX)}, consider choosing another MOSFET with lower parasitic capacitance.

For the low-side MOSFET (N_L), the worst-case power dissipation always occurs at maximum input voltage:

$$PD(NL\text{ Resistive}) = \left[1 - \left(\frac{V_{OUT}}{V_{IN(MAX)}} \right) \right] \times (I_{LOAD})^2 \times R_{DS(ON)}$$

The worst case for MOSFET power dissipation occurs under heavy overloads that are greater than I_{LOAD(MAX)}, but are not quite high enough to exceed the current limit and cause the fault latch to trip. To protect against this possibility, the circuit can be "over designed" to tolerate:

$$I_{LOAD} = \left(I_{VALLEY(MAX)} + \frac{\Delta I_{INDUCTOR}}{2} \right) = I_{VALLEY(MAX)} + \left(\frac{I_{LOAD(MAX)} \times LIR}{2} \right)$$

MAX17000A

Complete DDR2 and DDR3 Memory Power-Management Solution

where $I_{\text{VALLEY(MAX)}}$ is the maximum valley current allowed by the current-limit circuit, including threshold tolerance and on-resistance variation. The MOSFETs must have a good size heatsink to handle the overload power dissipation.

Choose a Schottky diode (DL) with a forward voltage low enough to prevent the low-side MOSFET body diode from turning on during the dead time. Select a diode that can handle the load current during the dead times. This diode is optional and can be removed if efficiency is not critical.

Setting the PWM Output Voltage

Preset Output Voltages

The MAX17000A's Dual Mode™ operation allows the selection of common voltages without requiring external components. Connect FB to AGND for a fixed 1.5V output, to V_{CC} for a fixed 1.8V output, or connect FB directly to OUT for a fixed 1.0V output.

Adjustable Output Voltage

The output voltage can be adjusted from 1.0V to 2.7V using a resistive voltage-divider (Figure 8). The MAX17000A regulates FB to a fixed reference voltage (1.0V). The adjusted output voltage is:

$$V_{\text{OUT}} = V_{\text{FB}} \times \left(1 + \frac{R_{\text{FBA}}}{R_{\text{FBB}}} \right)$$

where V_{FB} is 1.0V.

VTTI Input Capacitor Stability Considerations

The value of the VTTI bypass capacitor is chosen to limit the amount of ripple/noise at VTTI, and the amount of voltage dip during a load transient. Typically, VTTI is connected to the output of the buck regulator, which already has a large bulk capacitor. Nevertheless, a ceramic capacitor of equivalent value to the VTT output capacitor must be used and must be added and placed as close as possible to the VTTI pin. This value must be increased with larger load current, or if the trace from the VTTI pin to the power source is long and has significant impedance.

Setting VTT Output Voltage

The VTT output stage is powered from the VTTI input. The output voltage is set by the REFIN input. REFIN sets the feedback regulation voltage ($V_{\text{TTR}} = V_{\text{TTS}} = V_{\text{REFIN}}$) of the MAX17000A. Connect a 0.1V to 2.0V voltage input to set the adjustable output for VTT, VTTs, and VTR. If REFIN is tied to V_{CC} , the internal CSL/2 divider is used to set VTT voltage; hence, VTT tracks the V_{CSL} voltage and is set to $V_{\text{CSL}}/2$. This feature makes the MAX17000A ideal for memory applications in which the termination supply must track the supply voltage.

VTT Output Capacitor Selection

A minimum value of 9 μF is needed to stabilize a 300mA VTT output. This value of capacitance limits the regulator's unity-gain bandwidth frequency to approximately 1.2MHz (typ) to allow adequate phase margin for stability. To keep the capacitor acting as a capacitor within the regulator's bandwidth, it is important that ceramic capacitors with low ESR and ESL be used.

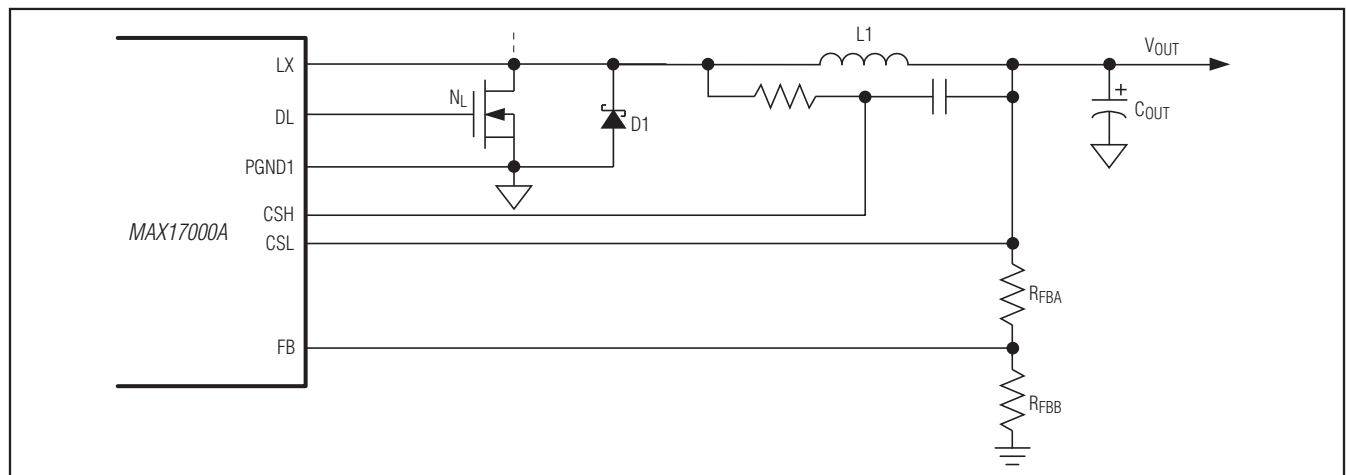

Figure 8. Setting V_{OUT} with a Resistive Voltage-Divider

Dual Mode is a trademark of Maxim Integrated Products, Inc.

MAX17000A

Complete DDR2 and DDR3 Memory Power-Management Solution

Since the gain bandwidth is also determined by the transconductance of the output FETs, which increases with load current, the output capacitor might need to be greater than 20 μ F if the load current exceeds 1.5A, but can be smaller than 20 μ F if the maximum load current is less than 1.5A. As a guideline, choose the minimum capacitance and maximum ESR for the output capacitor using the following:

$$C_{OUT_MIN} = 20\mu\text{F} \times \sqrt{\frac{I_{LOAD}}{1.5\text{A}}}$$

C_{OUT_MIN} needs to be increased by a factor of 2 for low-dropout operation:

$$R_{ESR_MAX} = 5\text{m}\Omega \times \sqrt{\frac{1.5\text{A}}{I_{LOAD}}}$$

R_{ESR_MAX} value is measured at the unity-gain-bandwidth frequency given by approximately:

$$f_{GBW} = \frac{36}{C_{OUT}} \times \sqrt{\frac{I_{LOAD}}{1.5\text{A}}}$$

Once these conditions for stability are met, additional capacitors, including those of electrolytic and tantalum types, can be connected in parallel to the ceramic capacitor (if desired) to further suppress noise or voltage ripple at the output.

VTTR Output Capacitor Selection

The VTTR buffer is a scaled-down version of the VTT regulator, with much smaller output transconductance. Its compensation capacitor can, therefore, be smaller and its ESR larger than what is required for its larger counterpart. For typical applications requiring load current up to $\pm 4\text{mA}$, a ceramic capacitor with a minimum value of 0.33 μ F is recommended ($R_{ESR} < 0.3\Omega$). Connect this capacitor between VTTR and the analog ground plane.

Power Dissipation

Power loss in the MAX17000A is the sum of the losses of the PWM block, the VTT LDO block, and the VTTR reference buffer:

$$PD(\text{PWM}) = I_{BIAS} \times 5\text{V} = 40\text{mA} \times 5\text{V} = 0.2\text{W}$$

$$PD(\text{VTT}) = 2\text{A} \times 0.9\text{V} = 1.8\text{W}$$

$$PD(\text{VTTR}) = 3\text{mA} \times 0.9\text{V} = 2.7\text{mW}$$

$$PD(\text{Total}) = 2\text{W}$$

The 2W total power dissipation is within the 24-pin TQFN multilayer board power dissipation specification of 2.22W. The typical application does not source or sink continuous high currents. VTT current is typically 100mA to 200mA in the steady state. VTTR is down in the microamp range, though the Intel specification requires 3mA for DDR1 and 1mA for DDR2. True worst-case power dissipation occurs on an output short-circuit condition with worst-case current limit. The MAX17000A does not employ any foldback current limiting, and relies on the internal thermal shutdown for protection. Both the VTT and VTTR output stages are powered from the same VTTI input. Their output voltages are referenced to the same REFIN input. The value of the VTTI bypass capacitor is chosen to limit the amount of ripple/noise at VTTI, or the amount of voltage dip during a load transient. Typically, VTTI is connected to the output of the buck regulator, which already has a large bulk capacitor.

Boost Capacitors

The boost capacitors (C_{BST}) must be selected large enough to handle the gate-charging requirements of the high-side MOSFETs. Typically, 0.1 μ F ceramic capacitors work well for low-power applications driving medium-sized MOSFETs. However, high-current applications driving large, high-side MOSFETs require boost capacitors larger than 0.1 μ F. For these applications, select the boost capacitors to avoid discharging the capacitor more than 200mV while charging the high-side MOSFETs' gates:

$$C_{BST} = \frac{Q_{GATE}}{200\text{mV}}$$

where Q_{GATE} is the total gate charge specified in the high-side MOSFET's data sheet. For example, assume the FDS6612A n-channel MOSFET is used on the high side. According to the manufacturer's data sheet, a single FDS6612A has a maximum gate charge of 13nC ($V_{GS} = 5\text{V}$). Using the above equation, the required boost capacitance would be:

$$C_{BST} = \frac{13\text{nC}}{200\text{mV}} = 0.065\mu\text{F}$$

Selecting the closest standard value, this example requires a 0.1 μ F ceramic capacitor.

MAX17000A

Complete DDR2 and DDR3 Memory Power-Management Solution

Applications Information

PCB Layout Guidelines

Careful PCB layout is critical to achieve low switching losses and clean, stable operation. The switching power stage requires particular attention. If possible, mount all the power components on the topside of the board, with their ground terminals flush against one another. Follow these guidelines for good PCB layout:

- Keep the high-current paths short, especially at the ground terminals. This practice is essential for stable, jitter-free operation.
- Keep the power traces and load connections short. This practice is essential for high efficiency. Using thick copper PCBs (2oz vs. 1oz) can enhance full-load efficiency by 1% or more. Correctly routing PCB traces is a difficult task that must be approached in terms of fractions of centimeters, where a single milliohm of excess trace resistance causes a measurable efficiency penalty.
- Minimize current-sensing errors by connecting CSH and CSL directly across the current-sense resistor (RSENSE).
- When trade-offs in trace lengths must be made, it is preferable to allow the inductor-charging path to be made longer than the discharge path. For example, it is better to allow some extra distance between the input capacitors and the high-side MOSFET than to allow distance between the inductor and the low-side MOSFET or between the inductor and the output filter capacitor.
- Route high-speed switching nodes (BST, LX, DH, and DL) away from sensitive analog areas (REFIN, FB, CSH, and CSL).

Layout Procedure

- 1) Place the power components first, with ground terminals adjacent (low-side MOSFET source, C_{IN}, C_{OUT}, and anode of the low-side Schottky). If possible, make all these connections on the top layer with wide, copper-filled areas.
- 2) Mount the controller IC adjacent to the low-side MOSFET, preferably on the backside opposite the MOSFETs to keep LX, GND, DH, and the DL gate-drive lines short and wide. The DL and DH gate traces must be short and wide (50 mils to 100 mils wide if the MOSFET is 1in from the controller IC) to keep the driver impedance low and for proper adaptive dead-time sensing.
- 3) Group the gate-drive components (BST diode and capacitor, V_{DD} bypass capacitor) together near the controller IC.
- 4) Make the DC-DC controller ground connections as shown in Figures 1 and 9. This diagram can be viewed as having two separate ground planes: power ground, where all the high-power components go; and an analog ground plane for sensitive analog components. The analog ground plane and power ground plane must meet only at a single point directly at the IC.
- 5) Connect the output power planes directly to the output filter capacitor positive and negative terminals with multiple vias. Place the entire DC-to-DC converter circuit as close as is practical to the load.

Table 5 lists the design differences between the MAX17000 and MAX17000A.

Table 5. MAX17000 vs. MAX17000A Design Differences

MAX17000	MAX17000A
$\overline{\text{STDBY}}$ = Low turns off VTT and overrides the $\overline{\text{SKIP}}$ setting, forcing the SMPS to enter a low-quiescent current ultra-skip mode.	$\overline{\text{STDBY}}$ = Low only turns off VTT rail, and does not affect SMPS operation.

MAX17000A

Complete DDR2 and DDR3 Memory Power-Management Solution

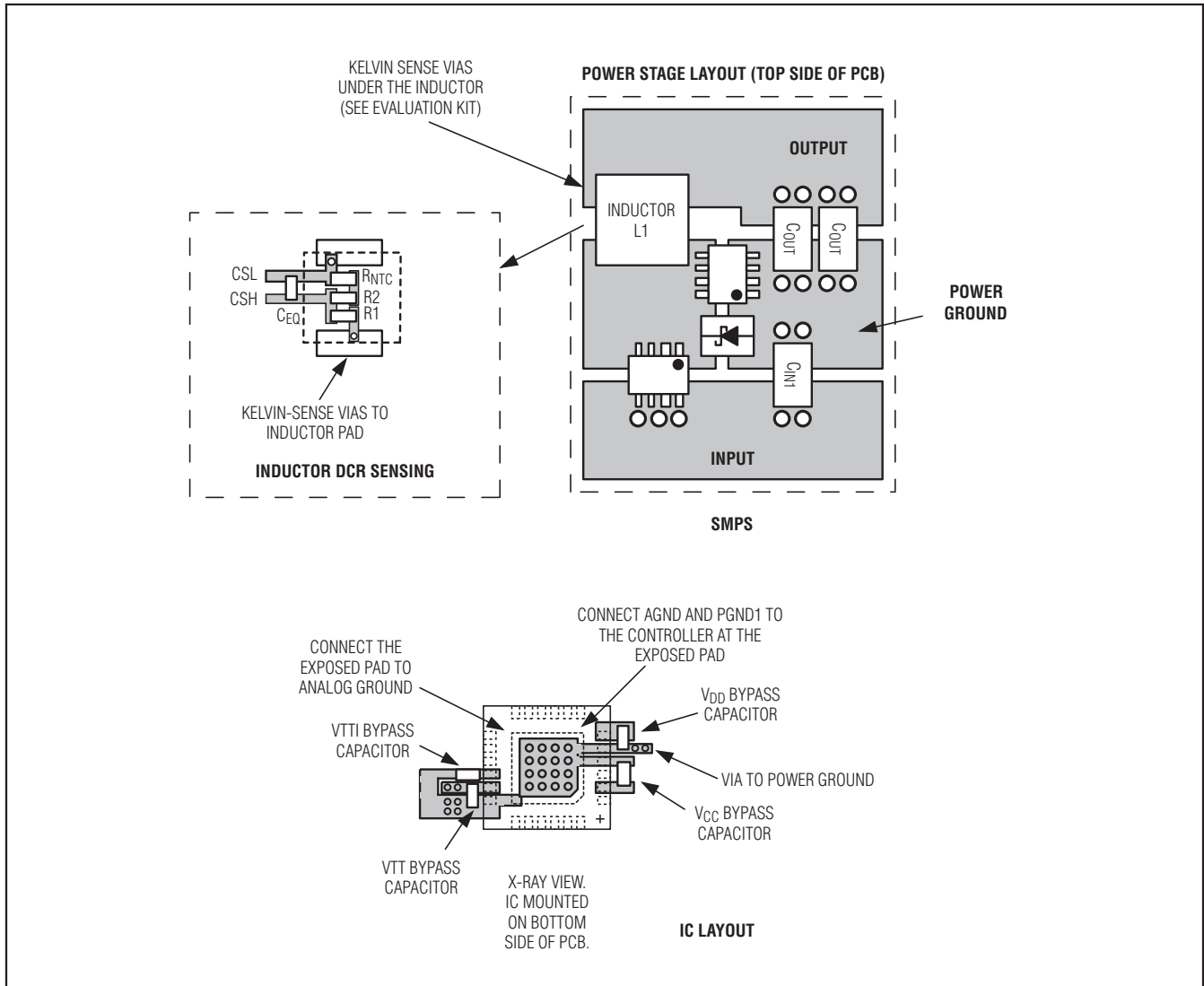

Figure 9. PCB Layout Example

Chip Information

TRANSISTOR COUNT: 7856
 PROCESS: BiCMOS

Package Information

For the latest package outline information and land patterns (footprints), go to www.maximintegrated.com/packages. Note that a "+", "#", or "-" in the package code indicates RoHS status only. Package drawings may show a different suffix character, but the drawing pertains to the package regardless of RoHS status.

PACKAGE TYPE	PACKAGE CODE	OUTLINE NO.	LAND PATTERN NO.
24 TQFN	T2444-4	21-0139	90-0022

MAX17000A

Complete DDR2 and DDR3 Memory Power-Management Solution

Revision History

REVISION NUMBER	REVISION DATE	DESCRIPTION	PAGES CHANGED
0	10/08	Initial release	—
1	12/08	Modified STDBY pin function	5, 11, 12, 13, 17, 23,
2	11/10	Changed RESR_MAX equation	29
3	4/13	Updated <i>Absolute Maximum Ratings</i>	2



Maxim Integrated cannot assume responsibility for use of any circuitry other than circuitry entirely embodied in a Maxim Integrated product. No circuit patent licenses are implied. Maxim Integrated reserves the right to change the circuitry and specifications without notice at any time. The parametric values (min and max limits) shown in the Electrical Characteristics table are guaranteed. Other parametric values quoted in this data sheet are provided for guidance.

X-ON Electronics

Largest Supplier of Electrical and Electronic Components

Click to view similar products for [Power Management Specialised - PMIC category](#):

Click to view products by [Maxim manufacturer](#):

Other Similar products are found below :

[LV5686PVC-XH](#) [FAN7710VN](#) [NCP391FCALT2G](#) [SLG7NT4081VTR](#) [SLG7NT4192VTR](#) [AP4313UKTR-G1](#) [AS3729B-BWLM](#)
[MB39C831QN-G-EFE2](#) [LV56841PVD-XH](#) [AP4306BUKTR-G1](#) [MIC5164YMM](#) [PT8A3252WE](#) [NCP392CSFCCT1G](#) [PT8A3284WE](#)
[PI3VST01ZEEX](#) [PI5USB1458AZAEX](#) [PI5USB1468AZAEX](#) [MCP16502TAC-E/S8B](#) [MCP16502TAE-E/S8B](#) [MCP16502TAA-E/S8B](#)
[MCP16502TAB-E/S8B](#) [TCKE712BNL,RF](#) [ISL91211AIKZT7AR5874](#) [ISL91211BIKZT7AR5878](#) [MCP16501TC-E/RMB](#) [ISL91212AIIZ-](#)
[TR5770](#) [ISL91212BIIZ-TR5775](#) [CPX200D](#) [AX-3005D-3](#) [TP-1303](#) [TP-1305](#) [TP-1603](#) [TP-2305](#) [TP-30102](#) [TP-4503N](#) [MIC5167YML-TR](#)
[LPTM21-1AFTG237C](#) [LR745N8-G](#) [MPS-3003L-3](#) [MPS-3005D](#) [SPD-3606](#) [STLUX383A](#) [TP-60052](#) [ADN8834ACBZ-R7](#) [LM26480SQ-](#)
[AA/NOPB](#) [LM81BIMTX-3/NOPB](#) [LM81CIMT-3/NOPB](#) [MIC5166YML-TR](#) [GPE-4323](#) [GPS-2303](#)