



MAX17000 Evaluation Kit

General Description

The MAX17000 evaluation kit (EV kit) is a fully assembled and tested surface-mount printed-circuit board (PCB) that demonstrates the MAX17000 DDR memory power solution. The EV kit provides the regulated voltages required in a complete DDR memory system. The EV kit generates the main memory voltage (VDDQ), the tracking sinking/sourcing termination voltage (VTT), and the reference voltage (VTTR).

The switch-mode power-supply (SMPS) regulator, which operates at 300kHz switching frequency, generates a preset 1.8V VDDQ (OUT) main memory voltage that is capable of sourcing 10A. The termination regulator provides a 0.9V VTT supply that is capable of sinking/sourcing 2A. The termination reference buffer provides a 0.9V VTTR supply that is capable of sinking/sourcing 3mA.

The EV kit requires an input voltage source of 7V to 20V (IN) and a low-power 5V (VDD) biasing supply.

Features

- ◆ Complete DDR Supplies: VDDQ, VTT, and VTTR
- ◆ VIN Range: 7V to 20V
- ◆ 300kHz Switching Frequency
- ◆ Independent Shutdown and Standby Controls
- ◆ Overvoltage Protection (OVP)
- ◆ Open-Drain, Power-Good Output Signal Indicators (PGOOD1 and PGOOD2)
- ◆ Low-Profile Surface-Mount Components
- ◆ Fully Assembled and Tested

Ordering Information

PART	TYPE
MAX17000EVKIT+	EV Kit

+ Denotes lead-free and RoHS compliant

Component List

DESIGNATION	QTY	DESCRIPTION
C1, C2	2	10 μ F \pm 20%, 25V X5R ceramic capacitors (1206) Murata GRM31CR61E106M TDK C3216X5R1E106M
C3	0	Not installed, ceramic capacitor (1206)
C4, C5	2	330 μ F \pm 20%, 2.5V, 12m Ω polymer capacitors SANYO 2R5TPE330MCC2 (1.8mm, 12m Ω , C2 case) NEC/TOKIN PSLV0E337M (1.8mm, 12m Ω , D case) Panasonic EEFCX0E331R (1.9mm, 15m Ω , D case)
C6	1	0.33 μ F \pm 10%, 10V X5R ceramic capacitor (0603) Murata GRM188R61A334K TDK C1608X5R1A334K
C7, C8, C9, C13–C17	8	10 μ F \pm 20%, 6.3V X5R ceramic capacitors (0603) Murata GRM188R60J106M TDK C1608X5R0J106M
C10, C18	2	1 μ F \pm 10%, 6.3V X5R ceramic capacitors (0603) Murata GRM188R60J105K TDK C1608X5R0J105K

DESIGNATION	QTY	DESCRIPTION
C11	1	0.1 μ F \pm 10%, 25V X7R ceramic capacitors (0603) Murata GRM188R71E104K TDK C1608X7R1E104K
C12, C19, C20, C21, C23	0	Not installed, ceramic capacitors (0603)
C22	1	1000pF \pm 10%, 50V X7R ceramic (0603) Murata GRM188R71H102K TDK C1608X7R1H102K
D1	0	Not installed, Schottky diode (SMA) 3A, 30V Schottky diode Nihon EC31QS03L Central CMSH3-40M LEAD FREE
D2, D3	2	Green surface-mount LEDs (0603) Lite-On LTST-C190GKT
JU1, JU3–JU6	5	2-pin headers
JU2	1	3-pin header
L1	1	1.4 μ H \pm 30%, 12A, 3.4m Ω (typ) power inductor Sumida CDEP105(L)NP-1R4 or 1.5 μ H \pm 30%, 14A, 5.1m Ω (typ) power inductor Würth 7443552150



MAX17000 Evaluation Kit

Component List (continued)

DESIGNATION	QTY	DESCRIPTION
N1	1	30V, 20A n-channel MOSFET (PowerPAK 8 SO) Fairchild FDMS8690
N2	1	30V, 40A n-channel MOSFET (PowerPAK 8 SO) Fairchild FDMS8660S
N3	0	Not installed, dual MOSFET (8 SO) Fairchild FDS6982S
PGOOD1, PGOOD2	0	Not installed, test points
R1	1	0.002 Ω \pm 1%, 1/2 W current-sense resistor (2010) Vishay WSL20102L000FEA
R2, R3	2	1k Ω \pm 5% resistors (0603)
R4–R7	4	100k Ω \pm 5% resistors (0603)
R8	1	200k Ω \pm 1% resistor (0603)
R9–R12, R14–R20	0	Not installed, resistors (0603) R9–R12 are shorted by PC trace; R14–R20 are open
R13	1	10 Ω \pm 5% resistor (0603)
TP1, TP2	2	Test points
U1	1	DDR memory power solution (24 TQFN) Maxim MAX17000ETG+
—	6	Shunts, 0.1in centers
—	1	PCB: MAX17000 Evaluation Kit+

Quick Start

Recommended Equipment

Before beginning, the following equipment is needed:

- 5V, 100mA DC power supply (VDD)
- 7V to 20V, 5A DC power supply (IN)
- Voltmeter

Procedure

The MAX17000 EV kit is fully assembled and tested. Follow the steps below to verify board operation.

Caution: Do not turn on the power supplies until all connections are completed.

- 1) Verify that the jumpers follow the default settings in Table 1.
- 2) Connect the positive terminal of the VDD power supply to the VDD pad. Connect the negative terminal of the VDD power supply to the AGND pad.
- 3) Connect the positive terminal of the IN power supply to the IN pad. Connect the negative terminal of the IN power supply to the PGND pad.
- 4) Set the IN power supply to 12V.
- 5) Set the VDD power supply to 5V.
- 6) Turn on the IN power supply before turning on the VDD power supply.
- 7) Verify that the VDDQ output (OUT) is approximately 1.8V.
- 8) Verify that the termination power-supply output (VTT) is approximately 0.9V.
- 9) Verify that the termination reference buffer output (VTTR) is approximately 0.9V.

Component Suppliers

SUPPLIER	PHONE	WEBSITE
Fairchild Semiconductor	888-522-5372	www.fairchildsemi.com
Murata Electronics North America, Inc.	770-436-1300	www.murata-northamerica.com
NEC TOKIN Corp.	408-324-1790	www.nec-tokinamerica.com
Panasonic Corp.	800-344-2112	www.panasonic.com
SANYO Electric Co., Ltd.	619-661-6835	www.sanyodevice.com
Sumida Corp.	847-545-6700	www.sumida.com
TDK Corp.	847-803-6100	www.component.tdk.com
Vishay	402-563-6866	www.vishay.com
Würth Elektronik GmbH & Co. KG	201-785-8800	www.we-online.com

Note: Indicate that you are using the MAX17000 when contacting these component suppliers.

MAX17000 Evaluation Kit

Evaluates: MAX17000

Table 1. Default Jumper Settings

JUMPER	SHUNT POSITION	FUNCTION
JU1	Not installed	OVP enabled
JU2	1-2	OUT fixed 1.8V
JU3	Not installed	Normal operation
JU4	Not installed	Forced-PWM operation
JU5	Not installed	Normal operation
JU6	Installed	V _{VTT} , V _{VTTR} track V _{CSL} /2

Detailed Description of Hardware

Jumper Selection

Several jumper settings in the following tables illustrate features of the MAX17000 EV kit. Refer to the MAX17000 IC data sheet for a more detailed description of each function.

OVP Mode Control (OVP)

The MAX17000 EV kit features a 2-pin jumper (JU1) to enable or disable the SMPS overvoltage protection (OVP) feature and output-discharge mode. By default (JU1 = open), the OVP input pin is pulled high to VDD through R4. The default setting enables the SMPS OVP. Place a shunt on JU1 to disable the SMPS OVP. Select the JU1 settings to drive the OVP mode control as shown in Table 2.

Table 2. Jumper JU1 Functions (OVP)

SHUNT POSITION	OVP PIN	OVERVOLTAGE PROTECTION
Installed	Connected to AGND	Disables OVP
Not installed*	Connected to VDD	Enables OVP

*Default position.

Feedback Input (FB)

The MAX17000 EV kit provides a 3-pin jumper (JU2) to control the feedback input (FB), which sets the V_{DDQ} (OUT) output voltage. Place a shunt across pins 1-2 (default) for a fixed 1.8V output or across pins 2-3 for a fixed 1.5V output. For an adjustable output (1V to 2.7V), uninstall the JU2 shunt and connect FB to a resistive divider from the output voltage. Install feedback resistors with values according to the following equation:

$$V_{OUT} = V_{FB} \left(1 + \frac{R_{14}}{R_{15}} \right)$$

where V_{FB} = 1V. Use 10kΩ for R₁₅, and calculate R₁₄ for the desired output voltage. Table 3 summarizes jumper JU2's function.

Table 3. Jumper JU2 Functions (FB)

SHUNT POSITION	FB PIN	V _{DDQ} (OUT)
1-2*	Connected to VDD	V _{OUT} = 1.8V
2-3	Connected to AGND	V _{OUT} = 1.5V
Not installed	Regulates to 1V	V _{OUT} = V _{FB} (1 + (R ₁₄ /R ₁₅))

*Default position.

Standby Control Input ($\overline{\text{STDBY}}$) and Shutdown Control Input (SHDN)

The EV kit features independent standby and shutdown controls by implementing jumpers JU3 and JU5 to control the $\overline{\text{STDBY}}$ and SHDN inputs, respectively. Jumpers JU3 and JU5 allow flexible sequencing to support all DDR operating states. The shutdown and standby control logic is illustrated in Table 4.

Table 4. Jumper JU3 ($\overline{\text{STDBY}}$) and JU5 (SHDN) Functions

SHUNT POSITION		V _{DDQ} OUTPUT (OUT)	V _T T	V _T T _R
JU3 ($\overline{\text{STDBY}}$)	JU5 (SHDN)			
X	Installed	Disabled	Disabled	Disabled
Not installed*	Not installed*	Enabled	Enabled	Enabled
Installed	Not installed	Enabled	Disabled	Enabled

*Default position.

X = Don't care condition.

MAX17000 Evaluation Kit

Pulse-Skipping Control Input ($\overline{\text{SKIP}}$)

The EV kit features a 2-pin jumper (JU4) for pulse-skipping control input. This input determines the mode of operation under normal steady-state conditions and dynamic output-voltage transitions. See Table 5 for JU4 functions.

Table 5. Jumper JU4 Functions ($\overline{\text{SKIP}}$)

SHUNT POSITION	$\overline{\text{SKIP}}$ PIN	OPERATIONAL MODE
Installed	Connected to AGND	Pulse-skipping mode (without forced-PWM during transitions)
Not installed*	Connected to VDD	Forced-PWM operation

*Default position.

External Reference Input (REFIN)

The EV kit features a 2-pin jumper (JU6) to select the reference input voltage (REFIN), which regulates the VTT and VTTR outputs. By default (REFIN connected to VDD through JU6), the VTT and VTTR outputs track $V_{\text{CSL}}/2$.

To set the adjustable output for VTT and VTTR, remove the shunt from JU6 and connect an external 0.5V to 1.5V supply at the REFIN pad. Another adjustable output option for VTT and VTTR is to install resistors R19 and R20 with values according to the following equation:

$$V_{\text{VTT}} = V_{\text{VTTR}} = V_{\text{REFIN}} = V_{\text{OUT}} \left(\frac{R20}{R19 + R20} \right)$$

Table 6 summarizes the JU6 functions.

Table 6. Jumper JU6 Functions (Reference Input)

SHUNT POSITION	REFIN	VTT AND VTTR VOLTAGE
Installed*	Connected to VDD	$V_{\text{CSL}}/2$
Not installed	Connected to REFIN pad (must be driven by external source)	V_{REFIN} (0.5V to 1.5V applied to the REFIN pad)
Not installed	V_{REFIN} connected to resistive dividers R19 and R20	$V_{\text{OUT}}(R20/(R19 + R20))$

*Default position.

Dual-MOSFET Operation

The MAX17000 EV kit can be evaluated with dual-package MOSFET N3. To evaluate the kit with a dual-package MOSFET, remove MOSFETs N1 and N2 and install N3. Vishay's Si4916DY is an example of a dual-package MOSFET that fits the N3 pinout and orientation.

MAX17000 Evaluation Kit

Evaluates: MAX17000

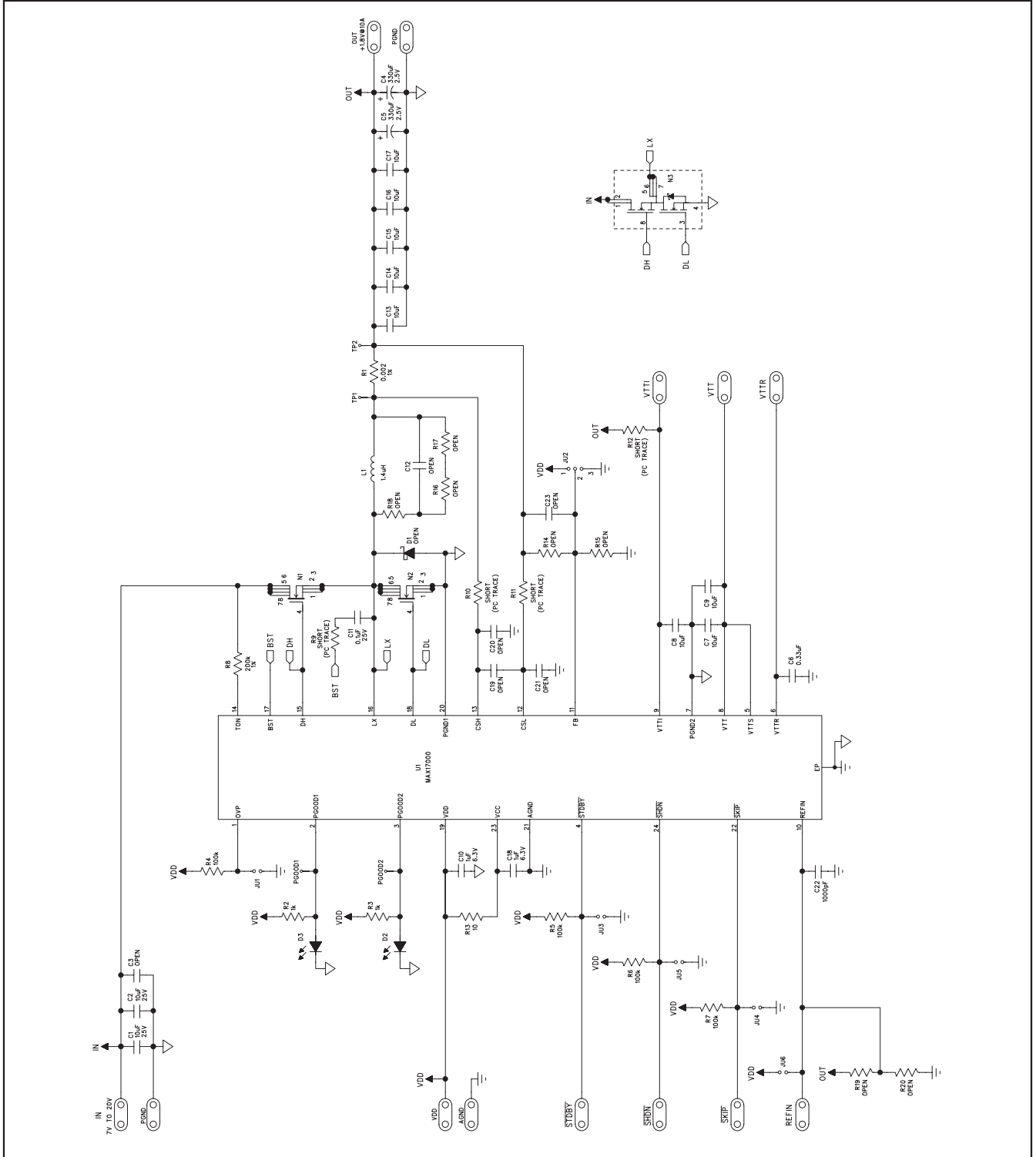



Figure 1. MAX17000 EV Kit Schematic

MAX17000 Evaluation Kit

MAX17000 EVALUATION KIT+		REV A
PROPERTY OF  INTEGRATED PRODUCTS		
LAYER TOP SILKSCREEN		
DATE:	ALL UNITS ARE IN 0.001"	

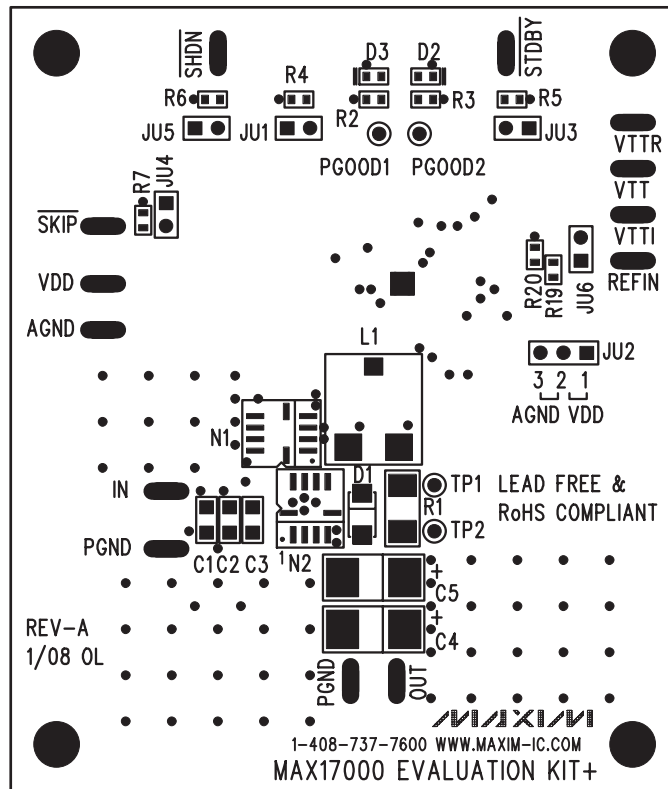



Figure 2. MAX17000 EV Kit Component Placement Guide—Component Side

MAX17000 Evaluation Kit

Evaluates: MAX17000

MAX17000 EVALUATION KIT+		REV A
PROPERTY OF  INTEGRATED PRODUCTS		
LAYER		COMPONENT SIDE
DATE:	ALL UNITS ARE IN 0.001"	

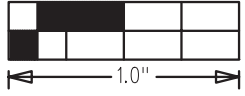
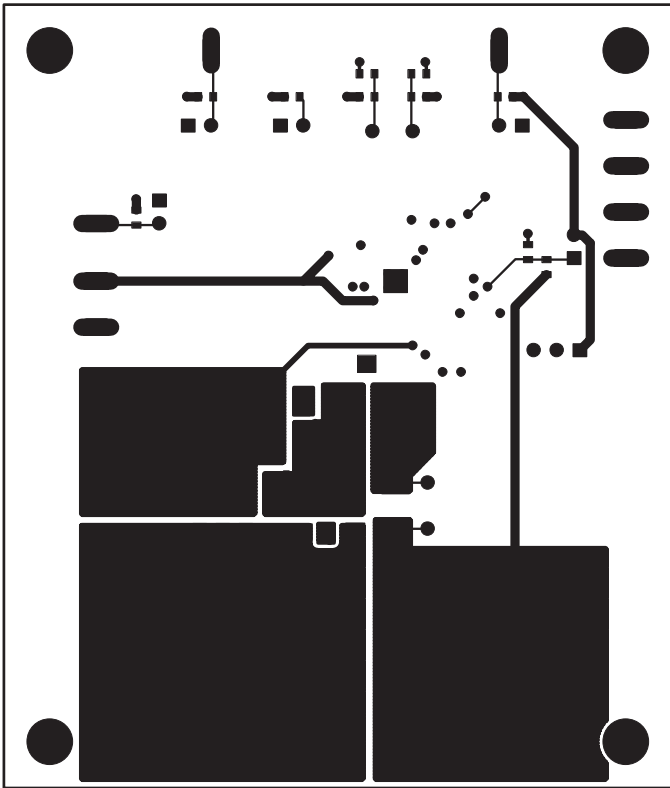

Figure 3. MAX17000 EV Kit PCB Layout—Component Side

MAX17000 Evaluation Kit

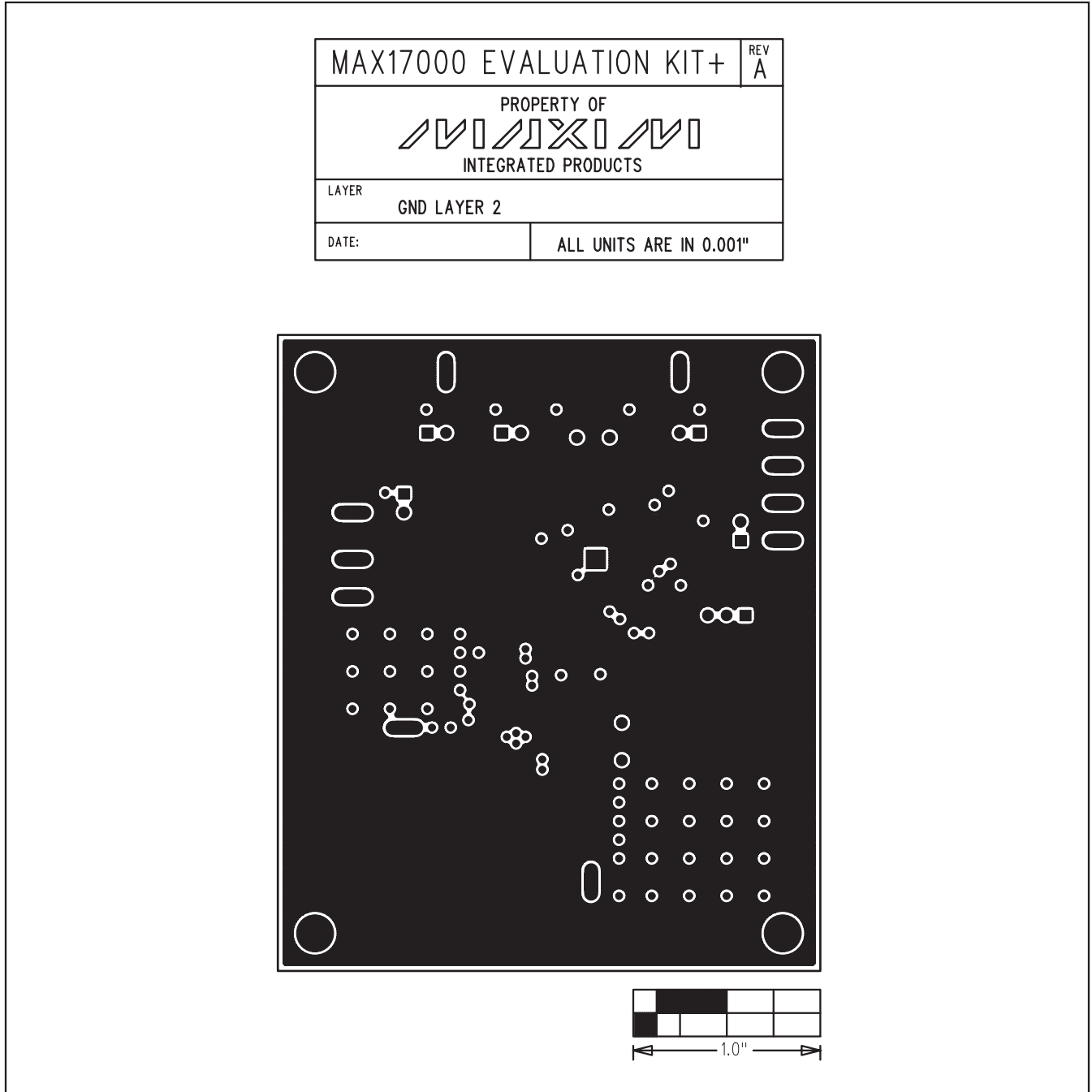
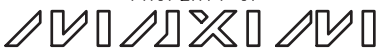

Figure 4. MAX17000 EV Kit PCB Layout—Internal Layer (Ground Plane)

MAX17000 Evaluation Kit

Evaluates: MAX17000

MAX17000 EVALUATION KIT+		REV A
PROPERTY OF  INTEGRATED PRODUCTS		
LAYER	VCC LAYER 3	
DATE:	ALL UNITS ARE IN 0.001"	

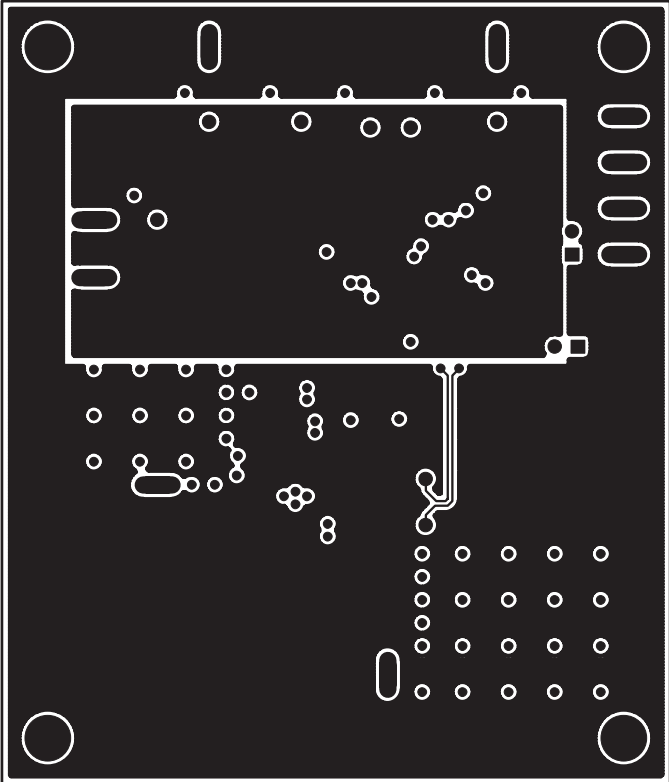

Figure 5. MAX17000 EV Kit PCB Layout—Internal Layer 3 (Ground Plane)

MAX17000 Evaluation Kit

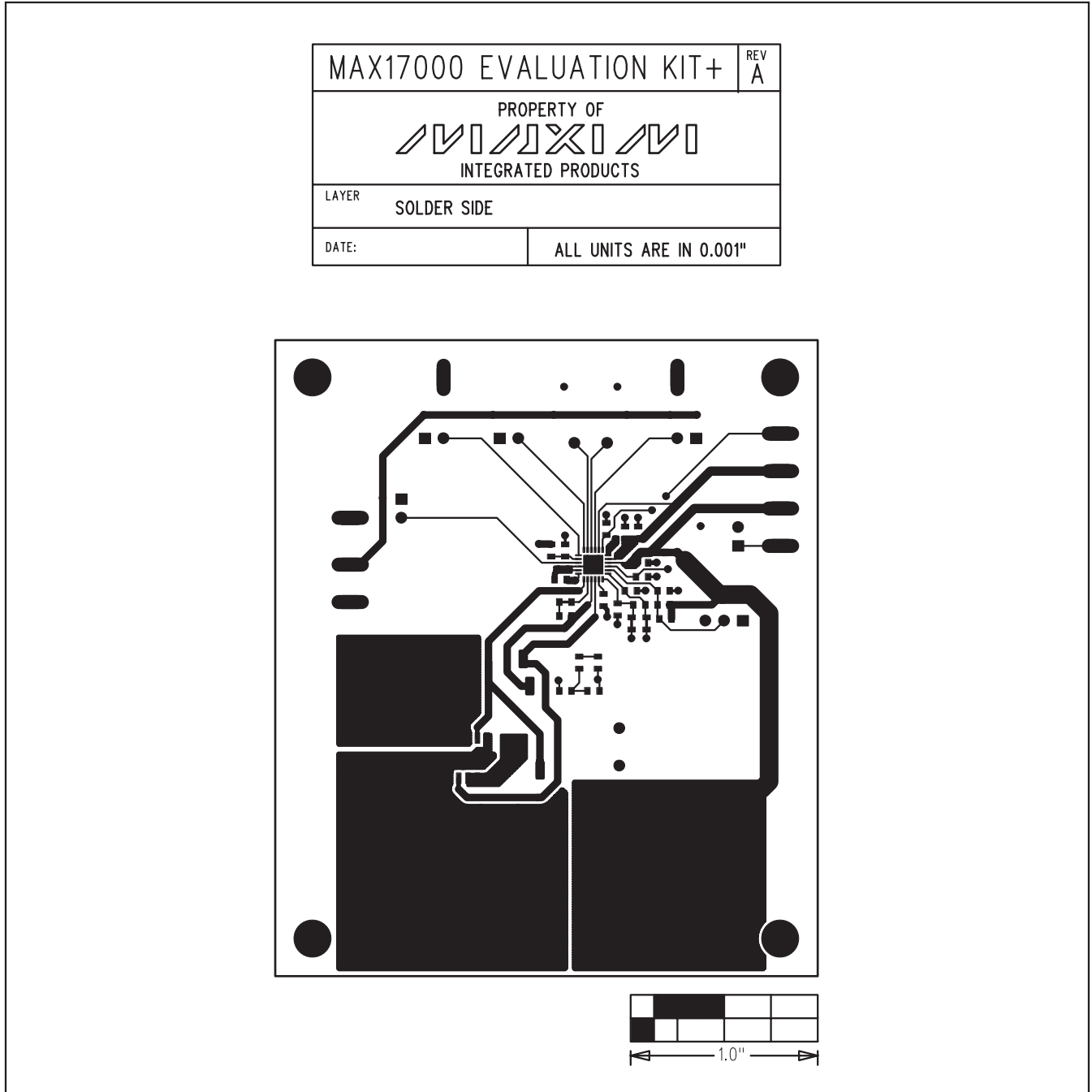

Figure 6. MAX17000 EV Kit PCB Layout—Solder Side

MAX17000 Evaluation Kit

Evaluates: MAX17000

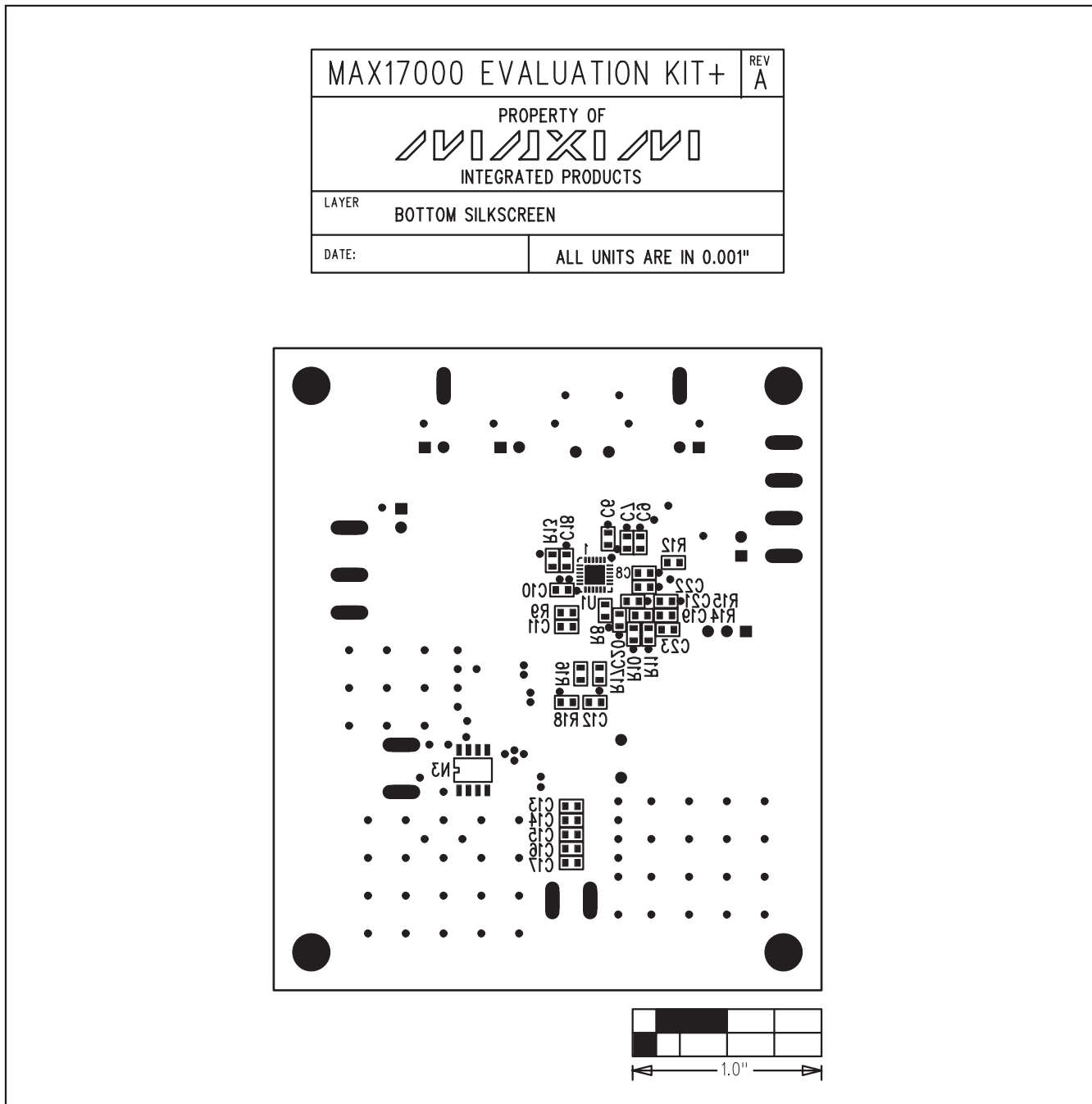

Figure 7. MAX17000 EV Kit Component Placement Guide—Solder Side

Maxim cannot assume responsibility for use of any circuitry other than circuitry entirely embodied in a Maxim product. No circuit patent licenses are implied. Maxim reserves the right to change the circuitry and specifications without notice at any time.

Maxim Integrated Products, 120 San Gabriel Drive, Sunnyvale, CA 94086 408-737-7600 _____ 11

X-ON Electronics

Largest Supplier of Electrical and Electronic Components

Click to view similar products for [Power Management IC Development Tools](#) category:

Click to view products by [Maxim](#) manufacturer:

Other Similar products are found below :

[EVB-EP5348UI](#) [MIC23451-AAAYFL EV](#) [MIC5281YMME EV](#) [124352-HMC860LP3E](#) [DA9063-EVAL](#) [ADP122-3.3-EVALZ](#) [ADP130-0.8-EVALZ](#) [ADP130-1.8-EVALZ](#) [ADP1740-1.5-EVALZ](#) [ADP1870-0.3-EVALZ](#) [ADP1874-0.3-EVALZ](#) [ADP199CB-EVALZ](#) [ADP2102-1.25-EVALZ](#) [ADP2102-1.875EVALZ](#) [ADP2102-1.8-EVALZ](#) [ADP2102-2-EVALZ](#) [ADP2102-3-EVALZ](#) [ADP2102-4-EVALZ](#) [AS3606-DB](#) [BQ25010EVM](#) [BQ3055EVM](#) [ISLUSBI2CKIT1Z](#) [LP38512TS-1.8EV](#) [EVAL-ADM1186-1MBZ](#) [EVAL-ADM1186-2MBZ](#) [ADP122UJZ-REDYKIT](#) [ADP166Z-REDYKIT](#) [ADP170-1.8-EVALZ](#) [ADP171-EVALZ](#) [ADP1853-EVALZ](#) [ADP1873-0.3-EVALZ](#) [ADP198CP-EVALZ](#) [ADP2102-1.0-EVALZ](#) [ADP2102-1-EVALZ](#) [ADP2107-1.8-EVALZ](#) [ADP5020CP-EVALZ](#) [CC-ACC-DBMX-51](#) [ATPL230A-EK](#) [MIC23250-S4YMT EV](#) [MIC26603YJL EV](#) [MIC33050-SYHL EV](#) [TPS60100EVM-131](#) [TPS65010EVM-230](#) [TPS71933-28EVM-213](#) [TPS72728YFFEVM-407](#) [TPS79318YEQEVM](#) [UCC28810EVM-002](#) [XILINXPWR-083](#) [LMR22007YMINI-EVM](#) [LP38501ATJ-EV](#)