



# MAX17021 Evaluation Kit

Evaluates: MAX17021

## General Description

The MAX17021 evaluation kit (EV kit) demonstrates the high-power, dynamically adjustable, multiphase IMVP-6.5+ notebook CPU application circuit. This DC-DC converter steps down high-voltage batteries and/or AC adapters, generating a precision, low-voltage CPU core  $V_{CC}$  rail. The MAX17021 EV kit meets the Intel mobile IMVP-6+ CPU's transient voltage specification, power-good signaling, voltage regulator thermal monitoring ( $\overline{VRHOT}$ ), and power-good output (PWRGD). The MAX17021 kit consists of the MAX17021 2-phase interleaved Quick-PWM™ step-down controller. The MAX17021 kit includes active voltage positioning with adjustable gain, reducing power dissipation and bulk output capacitance requirements. A slew-rate controller allows controlled transitions between VID codes, controlled soft-start and shutdown, and controlled exit suspend voltage. Precision slew-rate control provides “just-in-time” arrival at the new DAC setting, minimizing surge currents to and from the battery.

Two dedicated system inputs ( $\overline{PSI}$  and DPRSLPVR) dynamically select the operating mode and number of active phases, optimizing the overall efficiency during the CPU's active and sleep states.

The MAX17021 includes latched output undervoltage-fault protection, overvoltage-fault protection, and thermal-overload protection. It also includes a voltage regulator power-good (PWRGD) output, a clock enable (CLKEN) output, and a phase-good (PHASEGD) output.

This fully assembled and tested circuit board provides a digitally adjustable 0 to 1.5000V output voltage (7-bit on-board DAC) from a 7V to 24V battery input range. Each phase is designed for a 20A thermal design current, and delivers up to 30A peak output current for a total of 60A. The EV kit operates at 300kHz switching frequency (per phase) and has superior line- and load-transient response.

DESIGNATION	QTY	DESCRIPTION
$\overline{CLKEN}$ , DPRSLPVR, GND_SENSE, PGDIN, PHASEGD, $\overline{PSI}$ , PWRGD, V3P3, VOUT_SENSE, $\overline{VRHOT}$ , VR_ON	11	Test points

Quick-PWM is a trademark of Maxim Integrated Products, Inc.



## Features

- ◆ Dual-Phase, Fast-Response Interleaved, Quick-PWM
- ◆ Intel IMVP-6+ Code-Set Compliant (Montevina Socket Configuration)
- ◆ Dynamic Phase Selection Optimizes Active/Sleep Efficiency
- ◆ Transient Phase Overlap Reduces Output Capacitance
- ◆ Active Voltage Positioning with Adjustable Gain
- ◆ High Speed, Accuracy, and Efficiency
- ◆ Low-Bulk Output Capacitor Count
- ◆ 7V to 24V Input-Voltage Range
- ◆ 0 to 1.5000V Output-Voltage Range (7-Bit DAC)
- ◆ 60A Peak Load-Current Capability (30A Each Phase)
- ◆ Accurate Current Balance and Current Limit
- ◆ 300kHz Switching Frequency (per Phase)
- ◆ Power-Good (PWRGD) and Phase-Good (PHASEGD) Outputs and Indicators
- ◆ Clock Enable ( $\overline{CLKEN}$ ) and Thermal Fault ( $\overline{VRHOT}$ ) Outputs and Indicators
- ◆ Output Overvoltage and Undervoltage Fault Protections
- ◆ 40-Pin Thin QFN Package with Exposed Pad
- ◆ Lead(Pb)-Free and RoHS Compliant
- ◆ Fully Assembled and Tested

## Ordering Information

PART	TYPE
MAX17021EVKIT+	EV Kit

+Denotes lead(Pb)-free and RoHS compliant.

## Component List

DESIGNATION	QTY	DESCRIPTION
C1-C4	4	10 $\mu$ F $\pm$ 20%, 25V X5R ceramic capacitors (1210) Murata GRM32DR61E106KA12L TDK C3225X7R1E106M AVX 12103D106M Taiyo Yuden TMK325BJ106MM KEMET C1210C106M3RAC

# MAX17021 Evaluation Kit

## Component List (continued)

DESIGNATION	QTY	DESCRIPTION
C5–C8	4	330 $\mu$ F, 2V, 4.5m $\Omega$ low-ESR polymer capacitors (D case) Panasonic EEFSX0D331E4 or NEC TOKIN PSGV0E337M4.5 KEMET T520V337M2R5ATE4R5
C9	0	Not installed, ceramic capacitor (0805)
C10, C11	2	1 $\mu$ F $\pm$ 10%, 16V X5R ceramic capacitors (0603) TDK C1608X5R1C105K Taiyo Yuden EMK107BJ683MA Murata GRM188R61C105K
C12, C20–C27	0	Not installed, ceramic capacitors (0603) C12, C20–C26 are open; C27 is short (PC trace)
C13–C16, C28, C29	6	0.22 $\mu$ F $\pm$ 20%, 10V X7R ceramic capacitors (0603) Murata GRM188R71A224K Taiyo Yuden LMK107BJ224MA TDK C1608X7R1C224M AVX 06033D224KAT
C17, C18, C19	3	1000pF $\pm$ 10%, 50V X7R ceramic capacitors (0603) TDK C1608X7R1H102K or Murata GRM188R71H102K or equivalent
C30–C39, C62–C65	14	10 $\mu$ F $\pm$ 20%, 6.3V X5R ceramic capacitors (0805) TDK C2012X5R0J106M or Taiyo Yuden AMK212BJ106MG AVX 08056D106MAT
C40–C49	10	22 $\mu$ F, 6.3V X5R ceramic capacitors (0805) TDK C2012X5R0J226MT Taiyo Yuden JMK212BJ226MG
D1, D2	2	3A, 30V Schottky diodes Nihon EC31QS03L Central Semi CSMH3-40M
D3–D6	4	LEDs, green clear SMD (0805) LITE-ON Electronics LTST-C170GKT Digi-Key 160-1179-1-ND
JU1	0	Not installed, 3-pin header

DESIGNATION	QTY	DESCRIPTION
L1, L2	2	0.36 $\mu$ H, 36A, 0.82m $\Omega$ power inductors Panasonic ETQP4LR36ZFJ NEC TOKIN MPC1055LR36 TOKO FDUE1040D-R36M
N1, N2	2	n-channel MOSFETs (PowerPAK 8 SO) Fairchild FDS6298 (8 SO) Vishay (Siliconix) SI4386DY
N3–N6	4	n-channel MOSFETs (PowerPAK 8 SO) Fairchild FDS670 (8 SO) Vishay (Siliconix) SI4626ADY
N7	0	Not installed, n-channel MOSFET (D-PAK)
N8, N9	0	Not installed, n-channel MOSFETs (PowerPAK 8 SO)
R1, R15, R16, R43, R44	5	10 $\Omega$ $\pm$ 5% resistors (0603)
R2	1	59k $\Omega$ $\pm$ 1% resistor (0603)
R3	1	12.1k $\Omega$ $\pm$ 1% resistor (0603)
R4	1	200k $\Omega$ $\pm$ 1% resistor (0603)
R5, R6	2	0 $\Omega$ resistors (0603)
R7, R11	2	1.21k $\Omega$ $\pm$ 1% resistors (0603)
R8, R12	2	1.50k $\Omega$ $\pm$ 1% resistors (0603)
R9, R13	2	20k $\Omega$ $\pm$ 1% resistors (0603)
R10, R14	2	10k $\Omega$ $\pm$ 1% NTC thermistors, $\beta$ = 3380 (0603) Murata NCP18XH103F03RB TDK NTCG163JH103F
R17	1	4.32k $\Omega$ $\pm$ 1% resistor (0603)
R18, R24, R33, R34, R35,	0	Not installed, resistors (0603) R18, R24, and R33 are open; R34 and R35 are short (PC trace)
R19	1	51 $\Omega$ $\pm$ 5% resistor (0603)
R20	0	Not installed, 1W resistor (2512)
R21, R22, R23, R30	4	1k $\Omega$ $\pm$ 5% resistors (0603)
R25	1	13k $\Omega$ $\pm$ 1% resistor (0603)
R26	1	100k $\Omega$ $\pm$ 5% NTC thermistor, $\beta$ = 4250 (0603) Murata NCP18WF104J03RB TDK NTCG163JF104J (0402) or Panasonic ERT-J1VR104J

# MAX17021 Evaluation Kit

## Component List (continued)

DESIGNATION	QTY	DESCRIPTION
R27, R28, R29, R31, R32, R36–R42	12	100k $\Omega$ $\pm$ 5% resistors (0603)
R45, R46	2	2 $\Omega$ $\pm$ 5% resistors (0603)
SW1	1	7-position low-profile DIP switch
SW2	1	5-position low-profile DIP switch

DESIGNATION	QTY	DESCRIPTION
U1	1	Dual-phase, Quick-PWM VID controller (40 TQFN-EP*) Maxim MAX17021GTL+
U2	1	CPU socket MPGA479
—	1	PCB: MAX17021 Evaluation Kit+

\*EP = Exposed pad.

## Component Suppliers

SUPPLIER	PHONE	WEBSITE
AVX Corporation	843-946-0238	www.avxcorp.com
Central Semiconductor Corp.	631-435-1110	www.centralsemi.com
Digi-Key Corp.	800-344-4539	www.digikey.com
Fairchild Semiconductor	888-522-5372	www.fairchildsemi.com
KEMET Corp.	864-963-6300	www.kemet.com
Murata Electronics North America, Inc.	770-436-1300	www.murata-northamerica.com
NEC TOKIN America, Inc.	408-324-1790	www.nec-tokinamerica.com
Nihon Inter Electronics Corp.	847-843-7500	www.niec.co.jp
Panasonic Corp.	800-344-2112	www.panasonic.com
Taiyo Yuden	800-348-2496	www.t-yuden.com
TDK Corp.	847-803-6100	www.component.tdk.com
TOKO America, Inc.	847-297-0070	www.tokoam.com
Vishay	402-563-6866	www.vishay.com

**Note:** Indicate that you are using the MAX17021 when contacting these component suppliers.

## Quick Start

### Recommended Equipment

- MAX17021 EV kit
- 7V to 24V, > 100W power supply, battery, or notebook AC adapter
- DC bias power supply, 5V at 1A
- Dummy load capable of sinking 60A
- Digital multimeters (DMMs)
- 100MHz dual-trace oscilloscope

### Procedure

The MAX17021 EV kit is fully assembled and tested. Follow the steps below to verify board operation:

- 1) Ensure that the circuit is connected correctly to the supplies and dummy load prior to applying any power.
- 2) Verify that all positions of switch SW2 are off. The DAC code settings (D6–D0) are set by switch SW1. Set SW1 (1, 14), SW1 (2, 13), SW1 (4, 11), SW1 (5, 10),

and SW1 (7, 8) to the on positions. The output voltage is set for 1.050V.

- 3) Turn on the battery power before turning on the 5V bias power.
- 4) Observe the 1.050V output voltage with the DMM and/or oscilloscope. Look at the LX switching nodes and MOSFET gate-drive signals while varying the load current.

### Detailed Description of Hardware

This 60A peak multiphase buck-regulator design is optimized for a 300kHz switching frequency (per phase) and output-voltage settings around 1V. At  $V_{OUT} = 1V$  and  $V_{IN} = 12V$ , the inductor ripple is approximately 35% ( $LIR = 0.35$ ). The MAX17021 controller interleaves all the active phases, resulting in out-of-phase operation that minimizes the input and output filtering requirements. The multiphase controller shares the current between two phases that operate 180° out-of-phase, supplying up to 30A per phase.

# MAX17021 Evaluation Kit

## Setting the Output Voltage

The MAX17021 has an internal digital-to-analog converter (DAC) that programs the output voltage. The output voltage can be digitally set from 0 to 1.5000V (Table 2) from the D0–D6 pins. There are two different ways of setting the output voltage:

- 1) **Drive the external VID0–VID6 inputs (all SW1 positions are off).** The output voltage is set by driving VID0–VID6 with open-drain drivers (pullup resistors are included on the board) or 3V/5V CMOS output logic levels.

**Table 1. MAX17021 Operating Mode Truth Table**

INPUTS				PHASE OPERATION*	OPERATING MODE
SHDN SW2 (1, 10)	DPRSTP SW2 (5, 6)	DPRSLPVR SW2 (2, 9)	PSI SW2 (3, 8)		
GND	X	X	X	Disabled	Low-Power Shutdown Mode. DL1 and DL2 are forced low and the controller is disabled. The supply current drops to 1µA (max).
Rising	X	X	X	Multiphase Pulse Skipping 1/8 R <sub>TIME</sub> Slew Rate	Startup/Boot. When $\overline{\text{SHDN}}$ is pulled high, the MAX17021 begins the startup sequence. The controller enables the PWM controller and ramps the output voltage up to the boot voltage.
High	High	Low	High	Multiphase Forced-PWM Normal R <sub>TIME</sub> Slew Rate	Full Power. The no-load output voltage is determined by the selected VID DAC code (D0–D6, Table 2).
High	High	Low	Low	1-Phase Forced-PWM Normal R <sub>TIME</sub> Slew Rate	Intermediate Power. The no-load output voltage is determined by the selected VID DAC code (D0–D6, Table 2). When $\overline{\text{PSI}}$ is pulled low, the MAX17021 immediately disables phase 2. DH2 and DL2 are pulled low.
High	Low	High	X	1-Phase Pulse Skipping Normal R <sub>TIME</sub> Slew Rate	Deeper Sleep Mode. The no-load output voltage is determined by the selected VID DAC code (D0–D6, Table 2). When DPRSLPVR is pulled high, the MAX17021 immediately enters 1-phase pulse-skipping operation allowing automatic PWM/PFM switchover under light loads. The PWRGD and $\overline{\text{CLKEN}}$ upper thresholds are blanked during downward transitions. DH2 and DL2 are pulled low.
High	High	High	X	1-Phase Pulse Skipping 1/4 R <sub>TIME</sub> Slew Rate	Deeper Sleep Slow Exit Mode. The no-load output voltage is determined by the selected VID DAC code (D0–D6, Table 2). When DPRSTP is pulled high while DPRSLPVR is already high, the MAX17021 remains in one-phase pulse-skipping operation, allowing automatic PWM/PFM switchover under light loads, but reduces its slew rate to 1/4 of normal.
Falling	X	X	X	Multiphase Forced-PWM 1/8 R <sub>TIME</sub> Slew Rate	Shutdown. When $\overline{\text{SHDN}}$ is pulled low, the MAX17021 immediately pulls PWRGD and PHASEGD low, $\overline{\text{CLKEN}}$ becomes high impedance, all enabled phases are activated, and the output voltage is ramped down to ground. Once the output reaches 0V, the controller enters the low-power shutdown state.
High	X	X	X	Disabled	Fault Mode. The fault latch has been set by the MAX17021 UVP or thermal-shutdown protection, or by the OVP protection. The controller remains in fault mode until V <sub>CC</sub> power is cycled or $\overline{\text{SHDN}}$ toggled.

\*Multiphase operation = All enabled phases active.

X = Don't care.

# MAX17021 Evaluation Kit

Evaluates: MAX17021

Table 2. MAX17021 IMVP-6.5+ Output-Voltage VID DAC Codes

D6	D5	D4	D3	D2	D1	D0	OUTPUT VOLTAGE (V)	D6	D5	D4	D3	D2	D1	D0	OUTPUT VOLTAGE (V)
0	0	0	0	0	0	0	1.5000	1	0	0	0	0	0	0	0.7000
0	0	0	0	0	0	1	1.4875	1	0	0	0	0	0	1	0.6875
0	0	0	0	0	1	0	1.4750	1	0	0	0	0	1	0	0.6750
0	0	0	0	0	1	1	1.4625	1	0	0	0	0	1	1	0.6625
0	0	0	0	1	0	0	1.4500	1	0	0	0	1	0	0	0.6500
0	0	0	0	1	0	1	1.4375	1	0	0	0	1	0	1	0.6375
0	0	0	0	1	1	0	1.4250	1	0	0	0	1	1	0	0.6250
0	0	0	0	1	1	1	1.4125	1	0	0	0	1	1	1	0.6125
0	0	0	1	0	0	0	1.4000	1	0	0	1	0	0	0	0.6000
0	0	0	1	0	0	1	1.3875	1	0	0	1	0	0	1	0.5875
0	0	0	1	0	1	0	1.3750	1	0	0	1	0	1	0	0.5750
0	0	0	1	0	1	1	1.3625	1	0	0	1	0	1	1	0.5625
0	0	0	1	1	0	0	1.3500	1	0	0	1	1	0	0	0.5500
0	0	0	1	1	0	1	1.3375	1	0	0	1	1	0	1	0.5375
0	0	0	1	1	1	0	1.3250	1	0	0	1	1	1	0	0.5250
0	0	0	1	1	1	1	1.3125	1	0	0	1	1	1	1	0.5125
0	0	1	0	0	0	0	1.3000	1	0	1	0	0	0	0	0.5000
0	0	1	0	0	0	1	1.2875	1	0	1	0	0	0	1	0.4875
0	0	1	0	0	1	0	1.2750	1	0	1	0	0	1	0	0.4750
0	0	1	0	0	1	1	1.2625	1	0	1	0	0	1	1	0.4625
0	0	1	0	1	0	0	1.2500	1	0	1	0	1	0	0	0.4500
0	0	1	0	1	0	1	1.2375	1	0	1	0	1	0	1	0.4375
0	0	1	0	1	1	0	1.2250	1	0	1	0	1	1	0	0.4250
0	0	1	0	1	1	1	1.2125	1	0	1	0	1	1	1	0.4125
0	0	1	1	0	0	0	1.2000	1	0	1	1	0	0	0	0.4000
0	0	1	1	0	0	1	1.1875	1	0	1	1	0	0	1	0.3875
0	0	1	1	0	1	0	1.1750	1	0	1	1	0	1	0	0.3750
0	0	1	1	0	1	1	1.1625	1	0	1	1	0	1	1	0.3625
0	0	1	1	1	0	0	1.1500	1	0	1	1	1	0	0	0.3500
0	0	1	1	1	0	1	1.1375	1	0	1	1	1	0	1	0.3375
0	0	1	1	1	1	0	1.1250	1	0	1	1	1	1	0	0.3250
0	0	1	1	1	1	1	1.1125	1	0	1	1	1	1	1	0.3125
0	1	0	0	0	0	0	1.1000	1	1	0	0	0	0	0	0.3000
0	1	0	0	0	0	1	1.0875	1	1	0	0	0	0	1	0.2875
0	1	0	0	0	1	0	1.0750	1	1	0	0	0	1	0	0.2750
0	1	0	0	0	1	1	1.0625	1	1	0	0	0	1	1	0.2625
<b>0</b>	<b>1</b>	<b>0</b>	<b>0</b>	<b>1</b>	<b>0</b>	<b>0</b>	<b>1.0500</b>	1	1	0	0	1	0	0	0.2500
0	1	0	0	1	0	1	1.0375	1	1	0	0	1	0	1	0.2375
0	1	0	0	1	1	0	1.0250	1	1	0	0	1	1	0	0.2250
0	1	0	0	1	1	1	1.0125	1	1	0	0	1	1	1	0.2125

# MAX17021 Evaluation Kit

Table 2. MAX17021 IMVP-6.5+ Output-Voltage VID DAC Codes (continued)

D6	D5	D4	D3	D2	D1	D0	OUTPUT VOLTAGE (V)	D6	D5	D4	D3	D2	D1	D0	OUTPUT VOLTAGE (V)
0	1	0	1	0	0	0	1.0000	1	1	0	1	0	0	0	0.2000
0	1	0	1	0	0	1	0.9875	1	1	0	1	0	0	1	0.1875
0	1	0	1	0	1	0	0.9750	1	1	0	1	0	1	0	0.1750
0	1	0	1	0	1	1	0.9625	1	1	0	1	0	1	1	0.1625
0	1	0	1	1	0	0	0.9500	1	1	0	1	1	0	0	0.1500
0	1	0	1	1	0	1	0.9375	1	1	0	1	1	0	1	0.1375
0	1	0	1	1	1	0	0.9250	1	1	0	1	1	1	0	0.1250
0	1	0	1	1	1	1	0.9125	1	1	0	1	1	1	1	0.1125
0	1	1	0	0	0	0	0.9000	1	1	1	0	0	0	0	0.1000
0	1	1	0	0	0	1	0.8875	1	1	1	0	0	0	1	0.0875
0	1	1	0	0	1	0	0.8750	1	1	1	0	0	1	0	0.0750
0	1	1	0	0	1	1	0.8625	1	1	1	0	0	1	1	0.0625
0	1	1	0	1	0	0	0.8500	1	1	1	0	1	0	0	0.0500
0	1	1	0	1	0	1	0.8375	1	1	1	0	1	0	1	0.0375
0	1	1	0	1	1	0	0.8250	1	1	1	0	1	1	0	0.0250
0	1	1	0	1	1	1	0.8125	1	1	1	0	1	1	1	0.0125
0	1	1	1	0	0	0	0.8000	1	1	1	1	0	0	0	0
0	1	1	1	0	0	1	0.7875	1	1	1	1	0	0	1	0
0	1	1	1	0	1	0	0.7750	1	1	1	1	0	1	0	0
0	1	1	1	0	1	1	0.7625	1	1	1	1	0	1	1	0
0	1	1	1	1	0	0	0.7500	1	1	1	1	1	0	0	0
0	1	1	1	1	0	1	0.7375	1	1	1	1	1	0	1	0
0	1	1	1	1	1	0	0.7250	1	1	1	1	1	1	0	0
0	1	1	1	1	1	1	0.7125	1	1	1	1	1	1	1	0

2) **Switch SW1.** When SW1 positions are off, the MAX17021's D0–D6 inputs are at logic 1 (connected to VDD). When SW1 positions are on, D0–D6 inputs are at logic 0 (connected to GND). The output voltage can be changed during operation by activating SW1 on and off. As shipped, the EV kit is configured with SW1 positions set for 1.050V output (Table 2). Refer to the MAX17021 IC data sheet for more information.

### Reduced Power-Dissipation Voltage Positioning

The MAX17021 includes a transconductance amplifier for adding gain to the voltage-positioning sense path. The amplifier's input is generated by summing the current-sense inputs, which differentially sense the voltage across the inductor's DCR. The transconductance amplifier's output connects to the voltage-positioned feedback

input (FBAC), so the resistance between FBAC and  $V_{OUT}$  (R17) determines the voltage-positioning gain. Resistor R17 (4.32k $\Omega$ ) provides a -2.1mV/A voltage-positioning slope at the output when all phases are active. Remote output and ground sensing eliminate any additional PCB voltage drops.

### Dynamic Output-Voltage Transition Experiment

This MAX17021 EV kit is set to transition the output voltage at 12.6mV/ $\mu$ s. The speed of the transition is altered by scaling resistors R2 and R3.

During the voltage transition, watch the inductor current by looking at the current-sense inputs with a differential scope probe. Observe the low, well-controlled inductor current that accompanies the voltage transition. Slew-rate control during shutdown and startup results in well-controlled currents in to and out of the battery (input source).

# MAX17021 Evaluation Kit

There are two methods to create an output-voltage transition. Select D0–D6 (SW1). Then either manually change the SW1 settings to a new VID code setting (Table 2), or disable all SW1 settings and drive the VID0–VID6 PCB test points externally to the desired code settings.

## Load-Transient Experiment

One interesting experiment is to subject the output to large, fast load transients and observe the output with an oscilloscope. Accurate measurement of output ripple and load-transient response invariably requires that ground clip leads be completely avoided and the probe removed to expose the GND shield, so the probe can be directly grounded with as short a wire as possible to the board. Otherwise, EMI and noise pickup corrupt the waveforms.

Most benchtop electronic loads intended for power-supply testing lack the ability to subject the DC-DC converter to ultra-fast load transients. Emulating the supply current ( $di/dt$ ) at the IMVP-6.5+ VCORE pins requires at least 500A/ $\mu$ s load transients. An easy method for generating such an abusive load transient is to install a power MOSFET at the N7 location and install resistor R20 between 5m $\Omega$  and 10m $\Omega$  to monitor the transient current. Then drive its gate (TP1) with a strong pulse generator at a low-duty cycle (< 5%) to minimize

heat stress in the MOSFET. Vary the high-level output voltage of the pulse generator to vary the load current.

To determine the load current, you might expect to insert a meter in the load path, but this method is prohibited here by the need for low resistance and inductance in the path of the dummy-load MOSFET. To determine how much load current a particular pulse-generator amplitude is causing, observe the current through inductor L1. In the buck topology, the load current is approximately equal to the average value of the inductor current.

**Note:** The CPU socket is based on the Montevina platform pin configuration.

## Switch SW2 Settings

### Shutdown SW2 (1, 10)

When  $\overline{\text{SHDN}}$  goes low (SW2 (1, 10) = on), the MAX17021 enters low-power shutdown mode. PWRGD is pulled low immediately and the output voltage ramps down at 1/8 the slew rate set by R2 and R3 (71.1k $\Omega$ ). When the controller reaches the 0V target, the drivers are disabled (DL1 and DL2 driven low), the reference is turned off, and the IC supply currents drop to 1 $\mu$ A (max).

When a fault condition activates the shutdown sequence (output undervoltage lockout or thermal shut-

**Table 3. Shutdown Mode ( $\overline{\text{SHDN}}$ )**

SW2 (1, 10)	$\overline{\text{SHDN}}$ PIN	MAX17021 OUTPUT
Off*	Connected to VDD	Output enabled— $V_{\text{OUT}}$ is selected by VID DAC code (D0–D6) settings
On	Connected to GND	Shutdown mode, $V_{\text{OUT}} = 0\text{V}$

\*Default position.

**Table 4. DPRSLPVR,  $\overline{\text{PSI}}$**

DPRSLPVR SW2 (2, 9)	$\overline{\text{PSI}}$ SW2 (3, 8)	POWER LEVEL	OPERATING MODE
On (VDD)	X	Low current	1-phase pulse-skipping mode
Off (GND)	On (GND)	Intermediate	1-phase forced-PWM mode
Off (GND)*	Off (VDD)*	Full	Normal operation—all phases are active, forced-PWM mode

\*Default position.

X = Don't care.

**Table 5.  $\overline{\text{DPRSTP}}$**

SW2 (5, 6)	$\overline{\text{DPRSTP}}$ PIN	MAX17021
Off	Connected to VDD	1/4 of nominal slew rate is set by R2 and R3 if DPRSLPVR is also high
On*	Connected to GND	Nominal slew rate

\*Default position.

## MAX17021 Evaluation Kit

down), the protection circuitry sets the fault latch to prevent the controller from restarting. To clear the fault latch and reactivate the MAX17021, toggle  $\overline{\text{SHDN}}$  or cycle VDD power.

### **$\overline{\text{DPRSLPVR}}$ SW2 (2, 9), $\overline{\text{PSI}}$ SW2 (3, 8)**

$\overline{\text{DPRSLPVR}}$  and  $\overline{\text{PSI}}$  together determine the operating mode, as shown in Table 4. The MAX17021 will be forced into full-phase pulse-skipping mode during start-up and while in boot mode, and forced into full-phase PWM mode during the transition from boot mode to VID mode and during soft-shutdown.

### **$\overline{\text{DPRSTP}}$ , SW2 (5, 6)**

This 1V logic input signal together with the  $\overline{\text{DPRSLPVR}}$  signal selects between the nominal and “slow” (quarter of nominal rate) slew rates. When  $\overline{\text{DPRSTP}}$  and

$\overline{\text{DPRSLPVR}}$  are forced high, the slew rate is reduced to a quarter of the nominal slew rate.

### **PGDIN, SW2 (4, 7)**

PGDIN indicates the power status of other system rails and is used for power-supply sequencing. After power-up to the boot voltage, the output voltage remains at  $V_{\text{BOOT}}$ ,  $\overline{\text{CLKEN}}$  remains high, and  $\overline{\text{PWRGD}}$  remains low as long as the PGDIN stays low. When PGDIN is pulled high, the output transitions to selected VID voltage, and  $\overline{\text{CLKEN}}$  is pulled low. If the system pulls PGDIN low during normal operation, the MAX17021 immediately drives  $\overline{\text{CLKEN}}$  high, pulls  $\overline{\text{PWRGD}}$  low, and slews the output to the boot voltage (using 2-phase pulse-skipping mode). The controller remains at the boot voltage until PGDIN goes high again,  $\overline{\text{SHDN}}$  is toggled, or the VDD is cycled.

**Table 6. PGDIN**

SW2 (4, 7)	PGDIN PIN	MAX17021 OUTPUT
Off	Connected to GND	VOUT remains at the boot voltage. $\overline{\text{CLKEN}}$ remains high, and $\overline{\text{PWRGD}}$ remains low.
On*	Connected to VDD	VOUT transitions to selected VID voltage, and $\overline{\text{CLKEN}}$ is pulled low.

\*Default position.



# MAX17021 Evaluation Kit

Evaluates: MAX17021

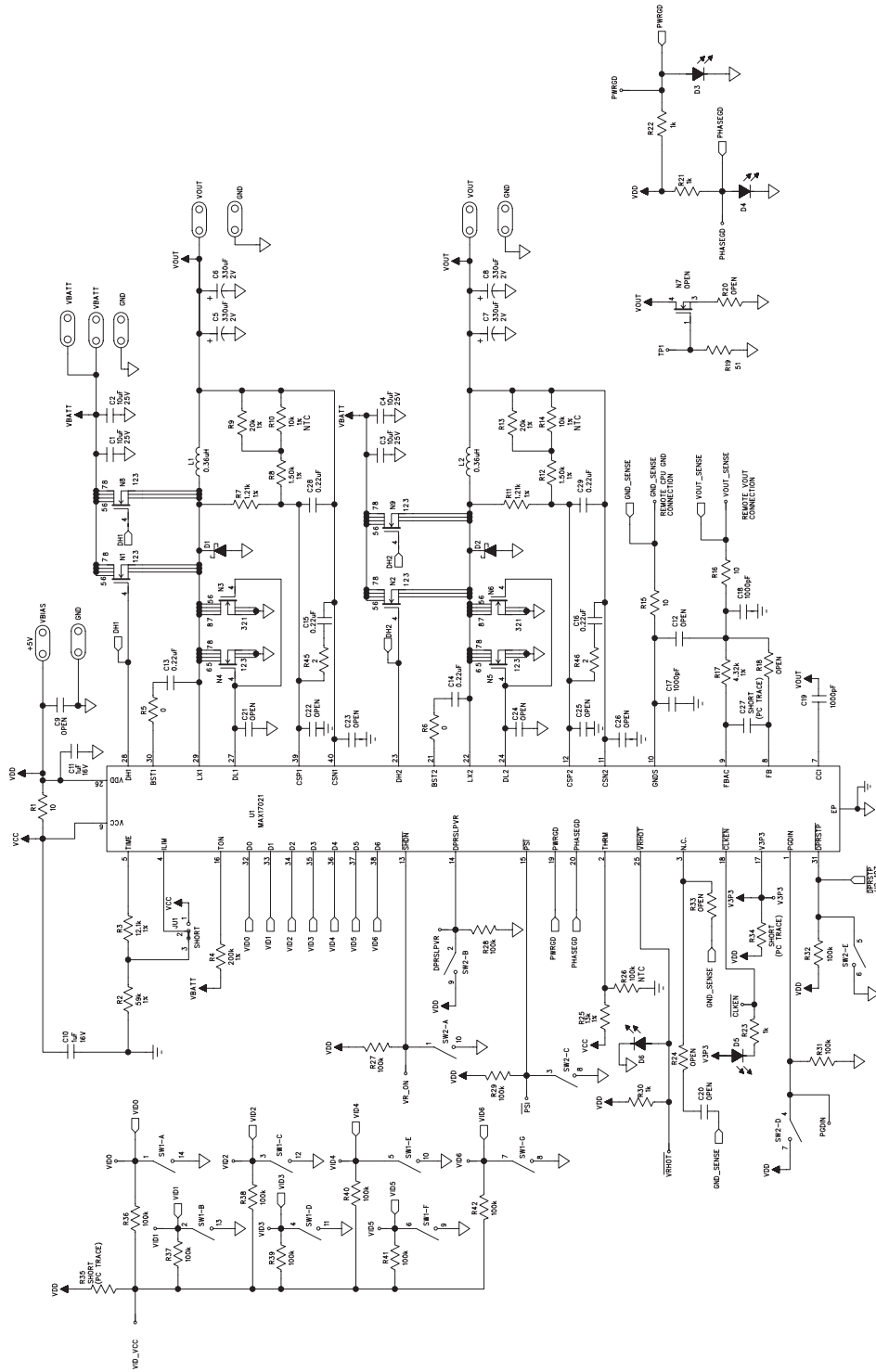

Figure 1a. MAX17021 EV Kit Schematic (Sheet 1 of 2)

# MAX17021 Evaluation Kit

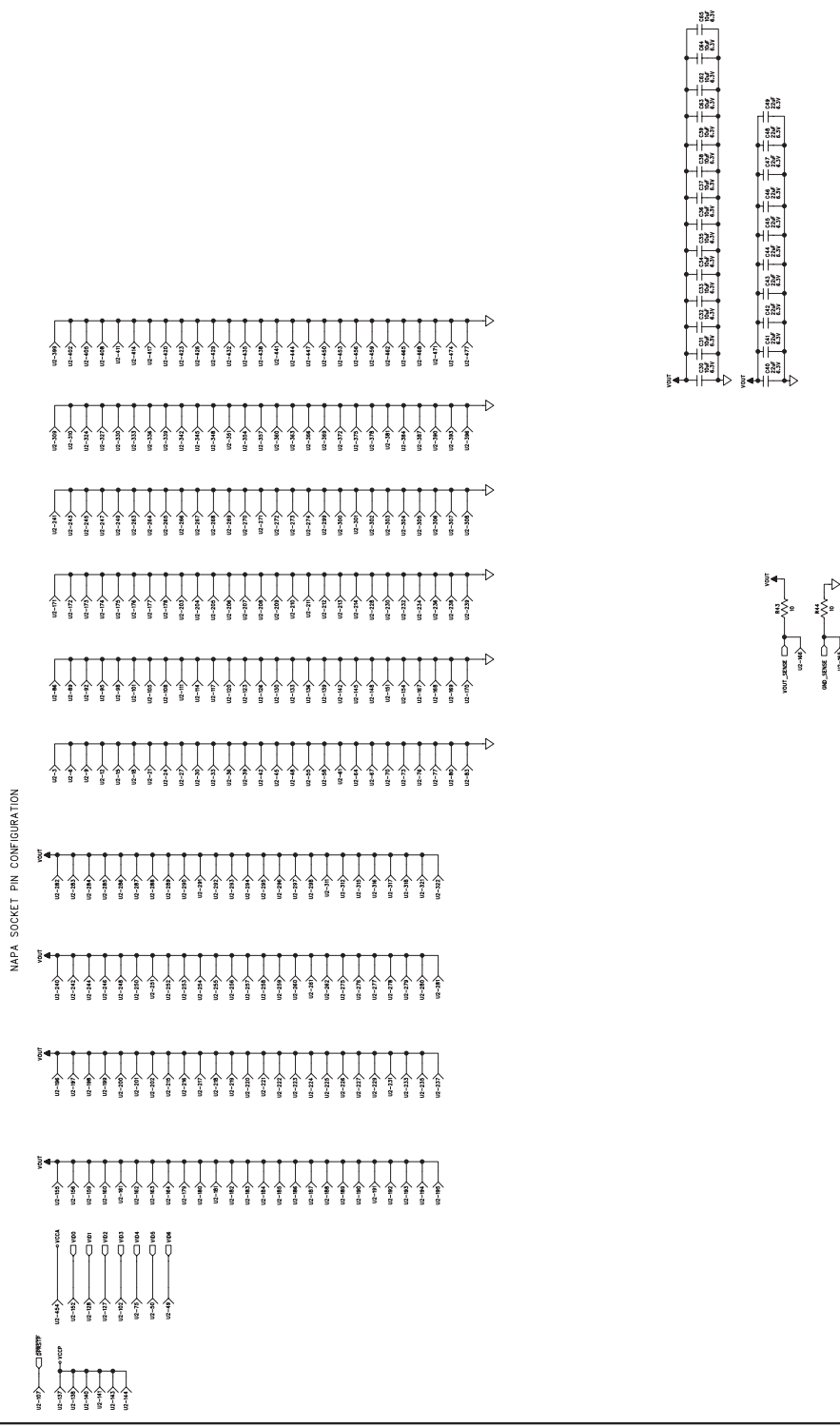

Figure 1b. MAX17021 EV Kit Schematic (Sheet 2 of 2)

# MAX17021 Evaluation Kit

Evaluates: MAX17021

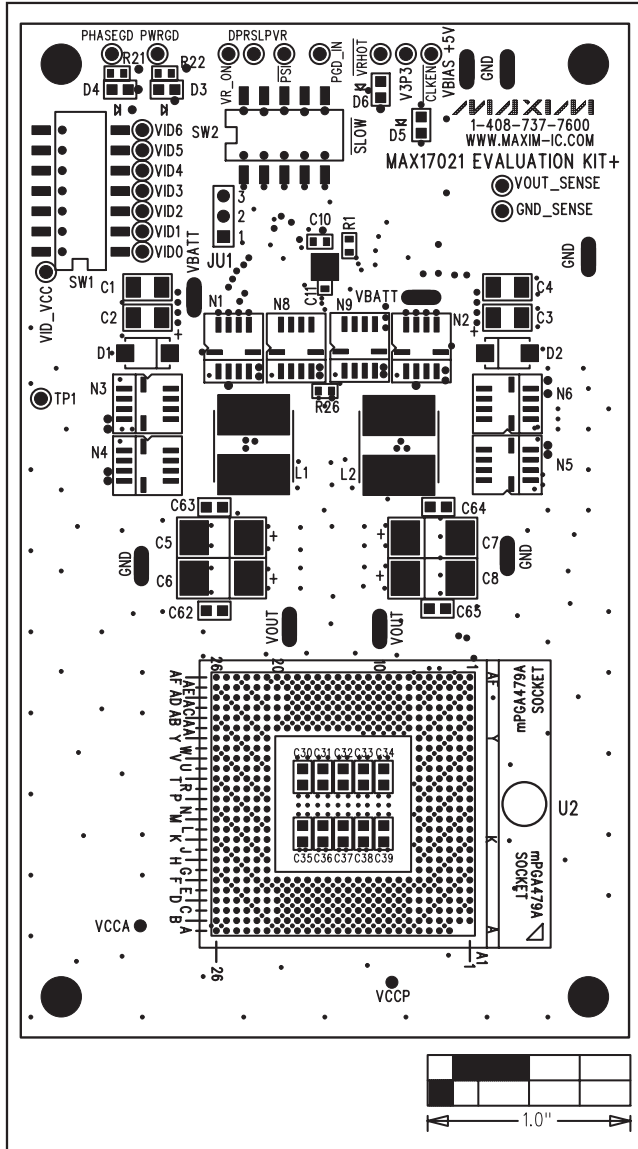

Figure 2. MAX17021 EV Kit Component Placement Guide—Component Side

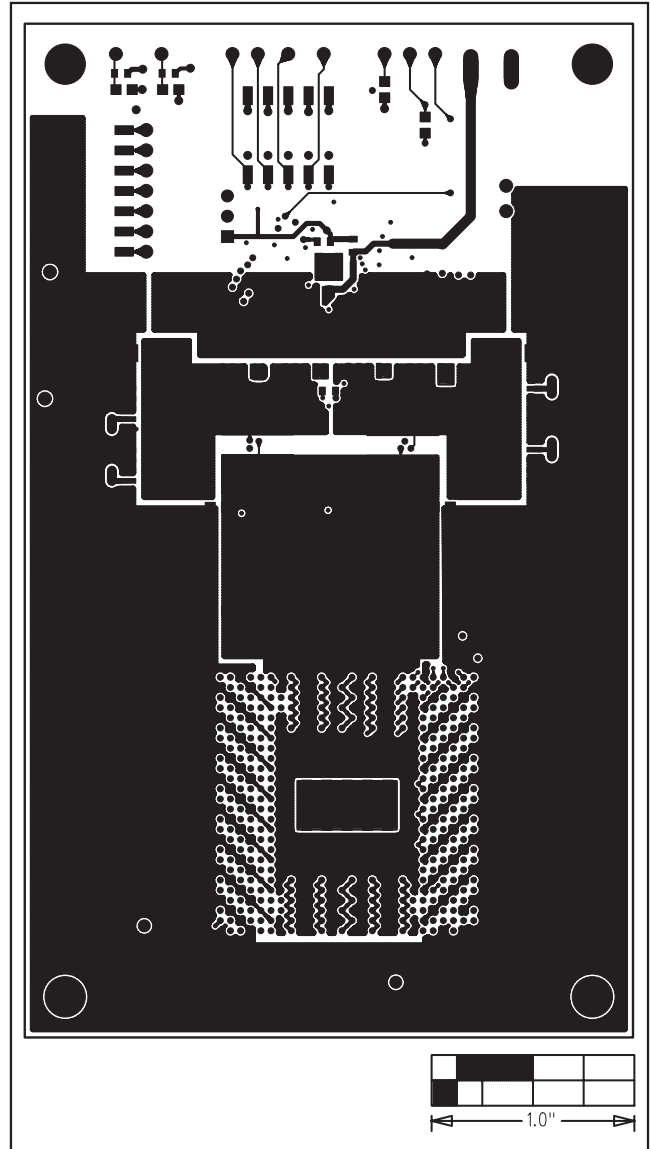

Figure 3. MAX17021 EV Kit PCB Layout—Component Side

# MAX17021 Evaluation Kit

Evaluates: MAX17021

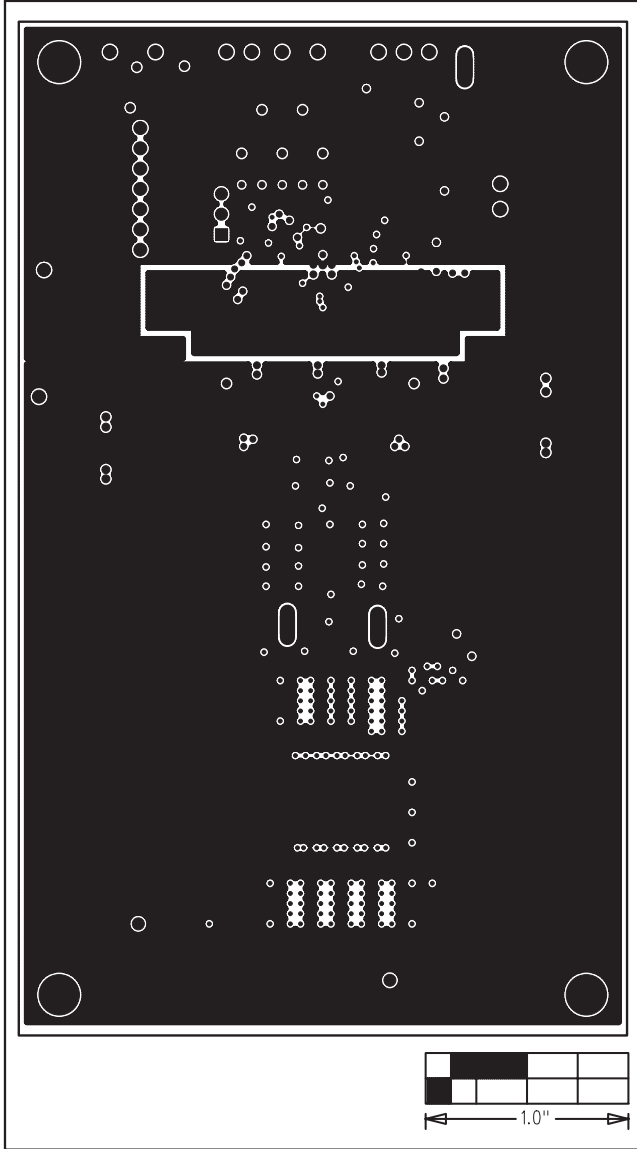

Figure 4. MAX17021 EV Kit PCB Layout—Internal Layer 2 (VBATT/PGND Plane)

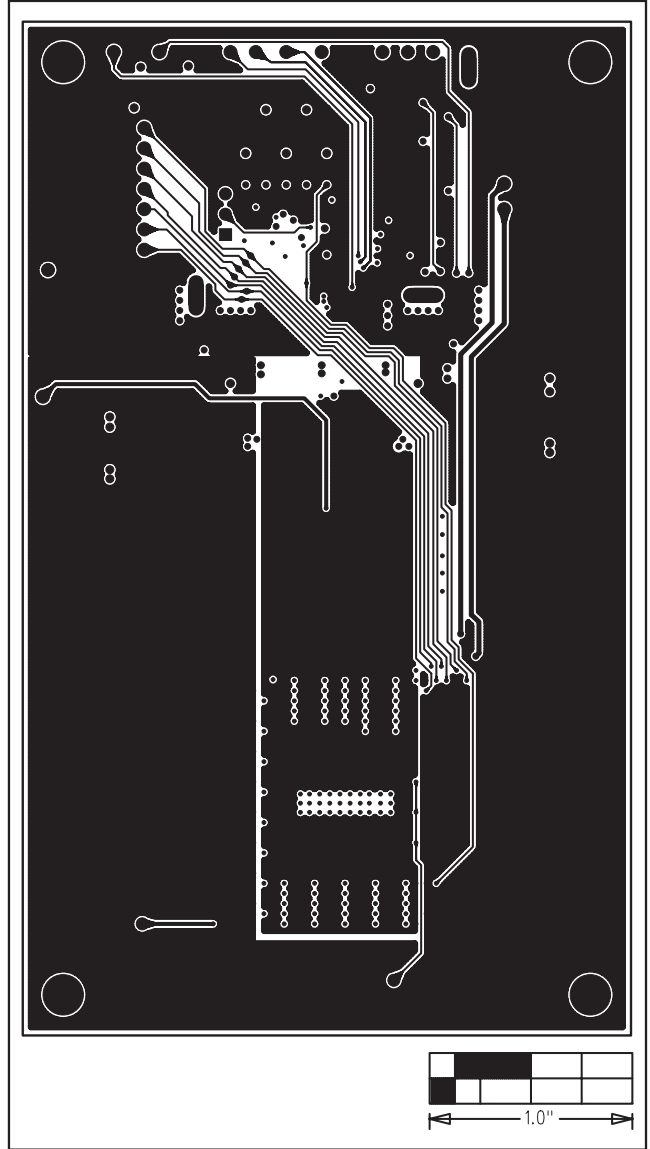

Figure 5. MAX17021 EV Kit PCB Layout—Internal Layer 3 (Signal Layer)

# MAX17021 Evaluation Kit

Evaluates: MAX17021

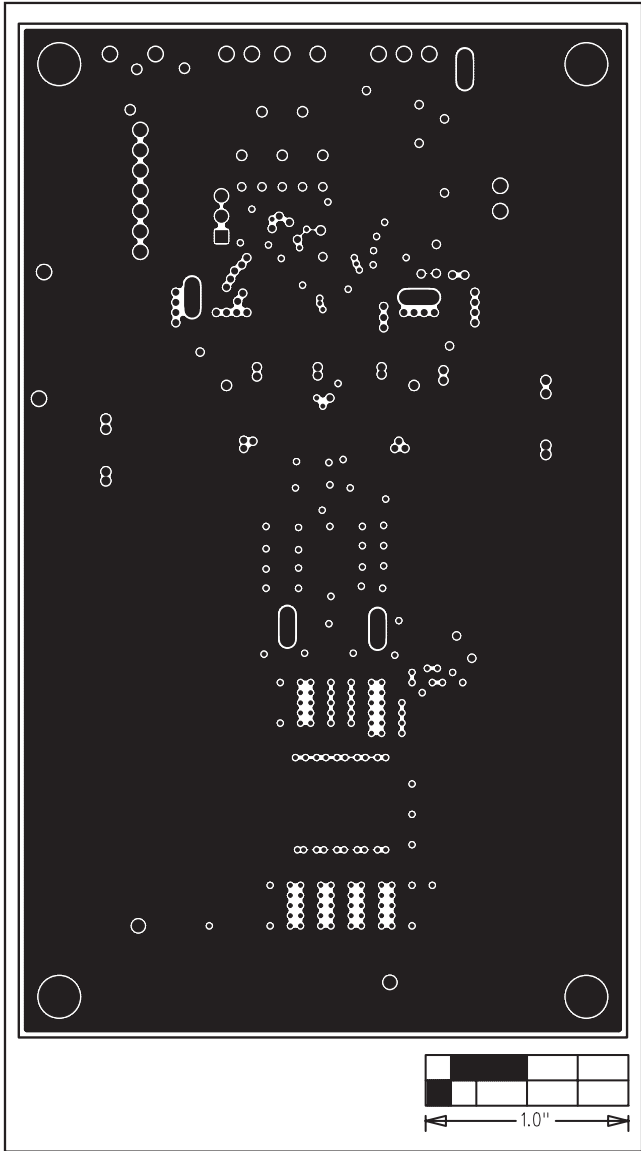

Figure 6. MAX17021 EV Kit PCB Layout—Internal Layer 4 (PGND Layer)

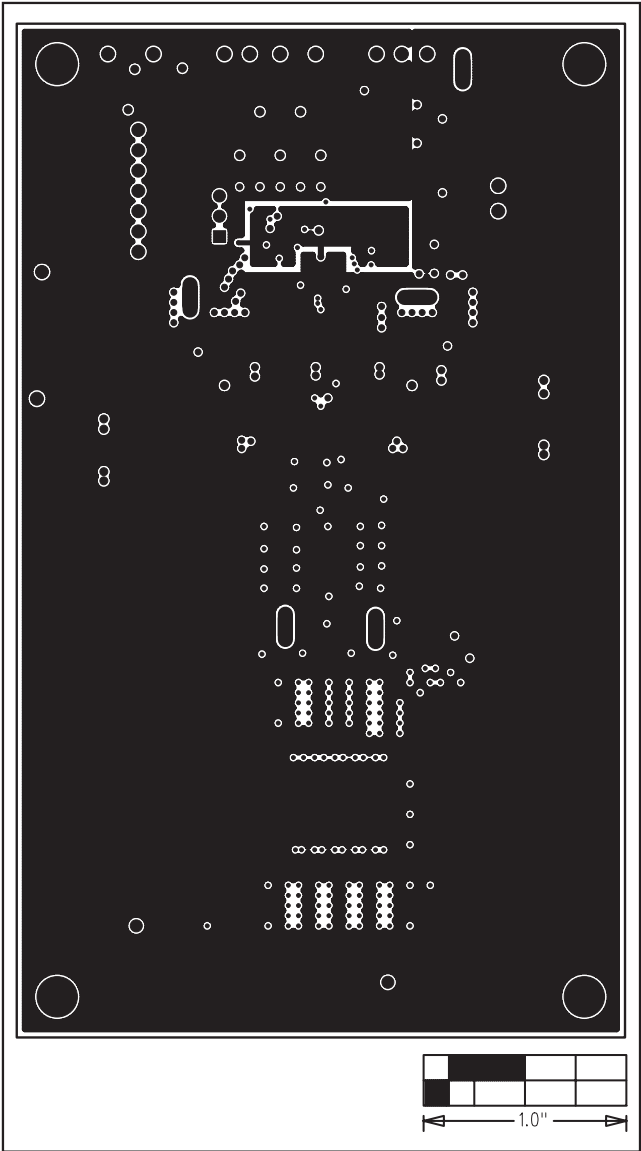

Figure 7. MAX17021 EV Kit PCB Layout—Internal Layer 5 (AGND/PGND Layer)

# MAX17021 Evaluation Kit

Evaluates: MAX17021

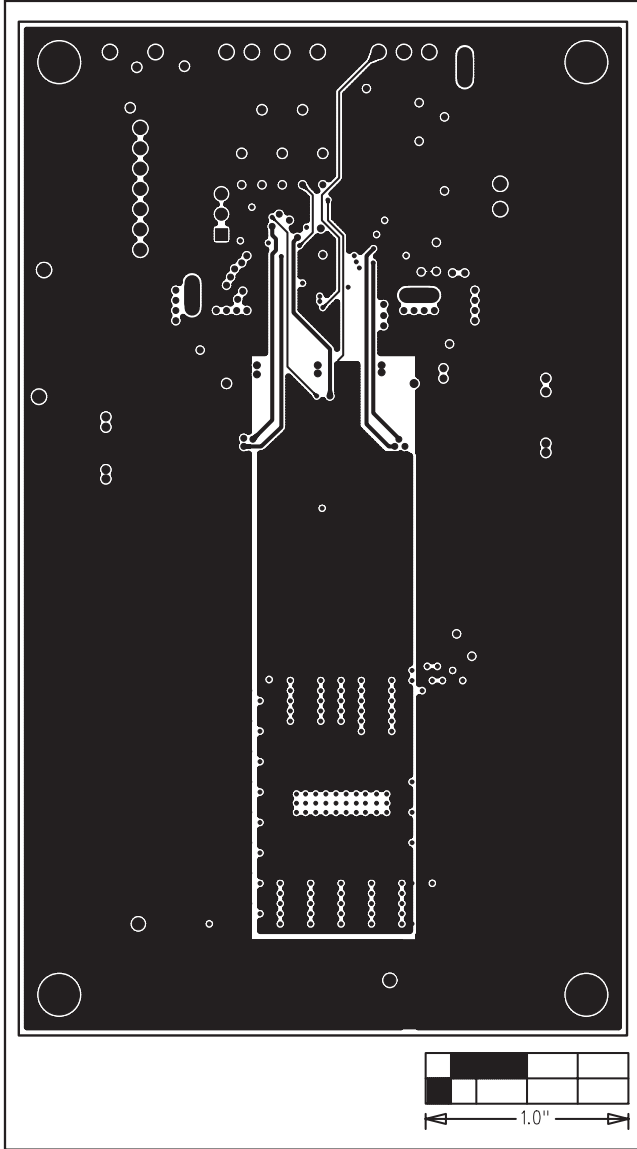

Figure 8. MAX17021 EV Kit PCB Layout—Internal Layer 6 (Signal Layer)

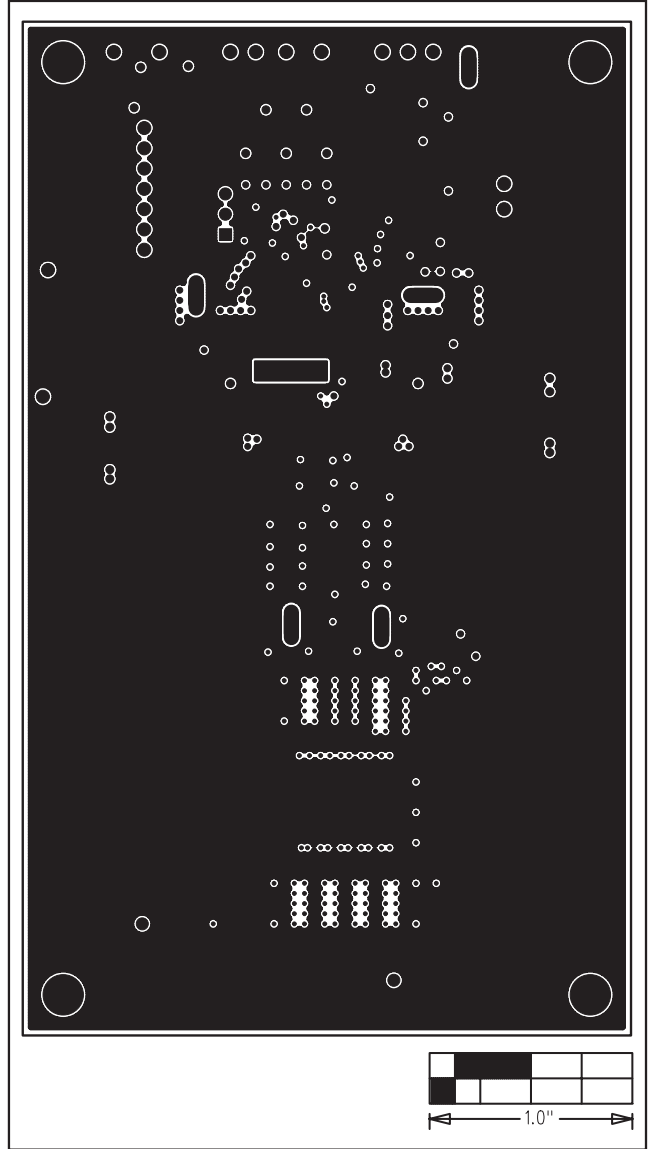

Figure 9. MAX17021 EV Kit PCB Layout—Internal Layer 7 (PGND Layer)

# MAX17021 Evaluation Kit

Evaluates: MAX17021

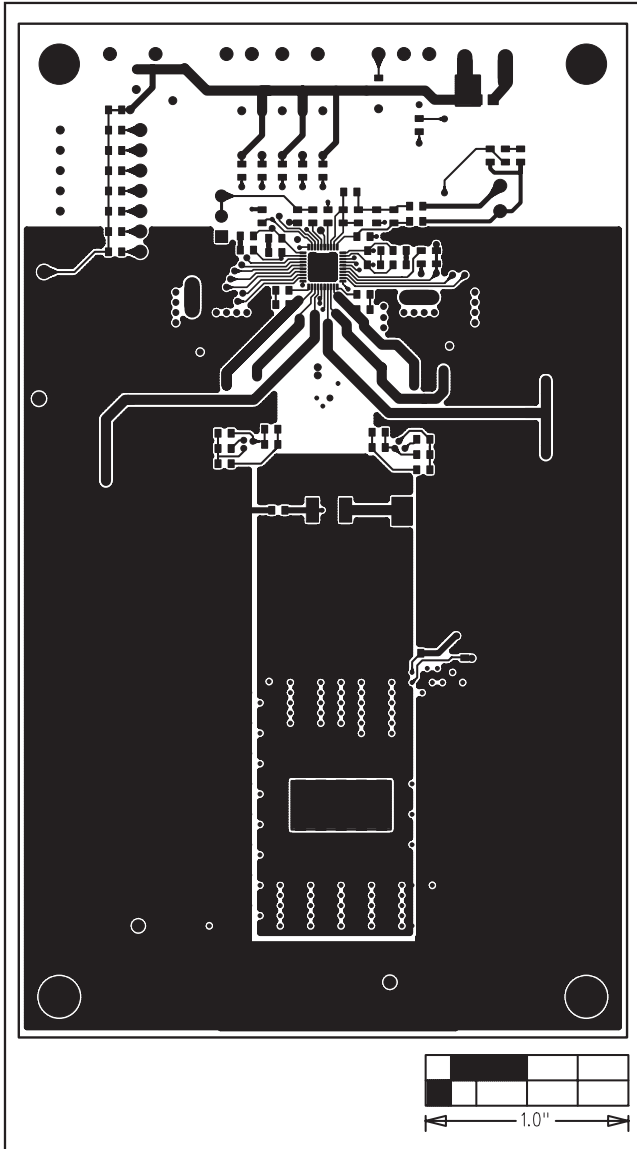

Figure 10. MAX17021 EV Kit PCB Layout—Solder Side

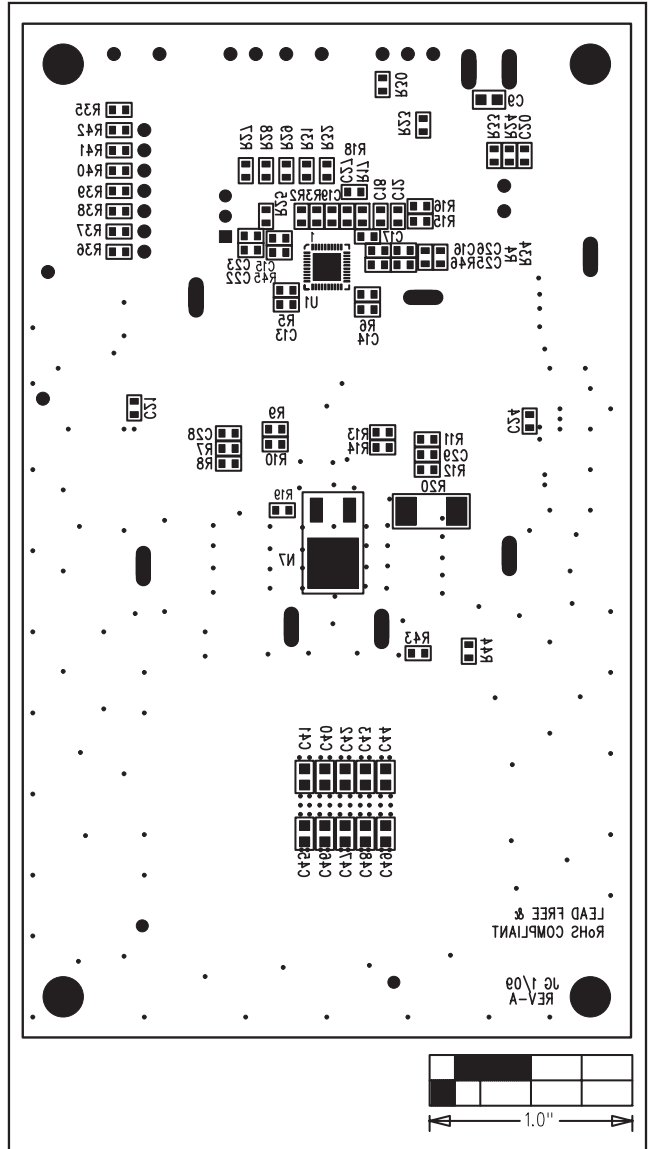

Figure 11. MAX17021 EV Kit Component Placement Guide—Solder Side

Maxim cannot assume responsibility for use of any circuitry other than circuitry entirely embodied in a Maxim product. No circuit patent licenses are implied. Maxim reserves the right to change the circuitry and specifications without notice at any time.

## X-ON Electronics

Largest Supplier of Electrical and Electronic Components

*Click to view similar products for [Power Management IC Development Tools](#) category:*

*Click to view products by [Maxim](#) manufacturer:*

Other Similar products are found below :

[EVB-EP5348UI](#) [MIC23451-AAAYFL EV](#) [MIC5281YMME EV](#) [124352-HMC860LP3E](#) [DA9063-EVAL](#) [ADP122-3.3-EVALZ](#) [ADP130-0.8-EVALZ](#) [ADP130-1.8-EVALZ](#) [ADP1740-1.5-EVALZ](#) [ADP1870-0.3-EVALZ](#) [ADP1874-0.3-EVALZ](#) [ADP199CB-EVALZ](#) [ADP2102-1.25-EVALZ](#) [ADP2102-1.875EVALZ](#) [ADP2102-1.8-EVALZ](#) [ADP2102-2-EVALZ](#) [ADP2102-3-EVALZ](#) [ADP2102-4-EVALZ](#) [AS3606-DB](#) [BQ25010EVM](#) [BQ3055EVM](#) [ISLUSBI2CKIT1Z](#) [LP38512TS-1.8EV](#) [EVAL-ADM1186-1MBZ](#) [EVAL-ADM1186-2MBZ](#) [ADP122UJZ-REDYKIT](#) [ADP166Z-REDYKIT](#) [ADP170-1.8-EVALZ](#) [ADP171-EVALZ](#) [ADP1853-EVALZ](#) [ADP1873-0.3-EVALZ](#) [ADP198CP-EVALZ](#) [ADP2102-1.0-EVALZ](#) [ADP2102-1-EVALZ](#) [ADP2107-1.8-EVALZ](#) [ADP5020CP-EVALZ](#) [CC-ACC-DBMX-51](#) [ATPL230A-EK](#) [MIC23250-S4YMT EV](#) [MIC26603YJL EV](#) [MIC33050-SYHL EV](#) [TPS60100EVM-131](#) [TPS65010EVM-230](#) [TPS71933-28EVM-213](#) [TPS72728YFFEVM-407](#) [TPS79318YEQEVM](#) [UCC28810EVM-002](#) [XILINXPWR-083](#) [LMR22007YMINI-EVM](#) [LP38501ATJ-EV](#)