

MAX17501B/MAX17501F Evaluation Kits

Evaluate: MAX17501B/MAX17501F in TDFN Packages

General Description

The MAX17501B/MAX17501F evaluation kits (EV kits) provide proven designs to evaluate the MAX17501B/MAX17501F high-efficiency, high-voltage, synchronous step-down DC-DC converters. The EV kits use these devices to generate a fixed 5V at load currents up to 500mA from a 6V to 60V input supply. The MAX17501B supports a PFM control scheme with high light-load efficiency, while the MAX17501F features a forced-PWM control scheme that provides constant switching-frequency operation at all load and line conditions.

Features

- ◆ Operates from a 6V to 60V Input Supply
- ◆ 5V Fixed Output Voltage
- ◆ 500mA Output Current
- ◆ 600kHz Switching Frequency
- ◆ Enable/UVLO Input
- ◆ Resistor-Programmable UVLO Threshold
- ◆ Open-Drain $\overline{\text{RESET}}$ Output
- ◆ Overcurrent and Overtemperature Protection
- ◆ PFM/PWM (MAX17501B EV Kit)
- ◆ PWM (MAX17501F EV Kit)
- ◆ Proven PCB Layout
- ◆ Fully Assembled and Tested

[Ordering Information](#) appears at end of data sheet.

Component List

DESIGNATION	QTY	DESCRIPTION
C1	1	1 μ F \pm 10%, 100V X7R ceramic capacitor (1206) Murata GRM31CR72A105KA01L
C2	1	1 μ F \pm 10%, 6.3V X7R ceramic capacitor (0603) Murata GRM188R70J105K
C3	1	3300pF \pm 10%, 50V X7R ceramic capacitor (0402) Murata GRM155R71H332K
C4	1	10 μ F \pm 10%, 10V X7R ceramic capacitor (1206) Murata GRM31CR71A106K
C7	1	33 μ F, 80V aluminum electrolytic (D = 8mm) Panasonic EEEFK1K330P

DESIGNATION	QTY	DESCRIPTION
JU1	1	3-pin header
L1	1	47 μ H, 1.4A inductor (6mm x 6mm x 3.5mm) Coilcraft LPS6235-473ML
R1	1	3.32M Ω \pm 1% resistor (0402)
R2	1	866k Ω \pm 1% resistor (0402)
R4	1	100 Ω resistor (0402)
R6	1	10k Ω \pm 1% resistor (0402)
TP1, TP2	0	Not installed, test points
U1	1	See the <i>EV Kit-Specific Component List</i>
—	1	Shunt
—	1	PCB: See the <i>EV Kit-Specific Component List</i>

MAX17501B/MAX17501F Evaluation Kits

Evaluate: MAX17501B/MAX17501F in TDFN Packages

EV Kit-Specific Component List

EV KIT	DESIGNATION	DESCRIPTION
MAX17501BTEVKIT#	U1	Buck converter (10 TDFN-EP*) Maxim MAX17501BATB+
	—	PCB: MAX17501BT EVALUATION KIT
MAX17501FTEVKIT#	U1	Buck converter (10 TDFN-EP*) Maxim MAX17501FATB+
	—	PCB: MAX17501FT EVALUATION KIT

*EP = Exposed pad.

Component Suppliers

SUPPLIER	PHONE	WEBSITE
Coilcraft, Inc.	847-639-6400	www.coilcraft.com
Murata Electronics North America, Inc.	770-436-1300	www.murata-northamerica.com
Panasonic Corp.	800-344-2112	www.panasonic.com

Note: Indicate that you are using the MAX17501 when contacting these component suppliers.

Quick Start

Recommended Equipment

- MAX17501B or MAX17501F EV kit
- 6V to 60V, 1A DC input power supply
- Load capable of sinking 500mA
- Digital voltmeter (DVM)
- Function generator

Procedure

The EV kit is fully assembled and tested. Follow the steps below to verify the board operation. **Caution: Do not turn on power supply until all connections are completed.**

- 1) Set the power supply at a voltage between 6V and 60V. Disable the power supply.
- 2) Connect the positive terminal of the power supply to the VIN PCB pad and the negative terminal to the nearest PGND PCB pad. Connect the positive terminal of the 500mA load to the VOUT PCB pad and the negative terminal to the nearest PGND PCB pad.
- 3) Connect the DVM across the VOUT PCB pad and the nearest PGND PCB pad.
- 4) Verify that a shunt is installed across pins 1-2 on jumper JU1.

- 5) Turn on the DC power supply.
- 6) Enable the load.
- 7) Verify that the DVM displays the expected voltage.

To turn-on/off the part from EN/UVLO, follow the steps below:

- 1) Remove resistors R1 and R2 and the jumper installed across pins 1-2 on jumper JU1.
- 2) Connect the power supply to the EV kit and turn on the power supply. Set the power supply at a voltage between 6V and 60V.
- 3) Connect the function generator output to the EN/UVLO test loop.
- 4) EN/UVLO rising threshold is 1.24V and falling threshold is 1.11V. Make sure that the voltage-high and voltage-low levels of the function generator output are greater than 1.24V and less than 1.11V, respectively.
- 5) While powering down the EV kits, first disconnect the function generator output from the EN/UVLO test loop and then turn off the DC power supply.

Care should be taken in board layout and systems wiring to prevent violation of the absolute maximum rating of the FB/VO pin under short-circuit conditions. Under such conditions, it is possible for the ceramic output capacitor to oscillate with the board or wiring inductance between the

MAX17501B/MAX17501F Evaluation Kits

Evaluate: MAX17501B/MAX17501F in TDFN Packages

capacitor and short-circuited load, and thereby cause the absolute maximum rating of FB/VO (-0.3V) to be exceeded. This parasitic board or wiring inductance should be minimized and the output voltage waveform under short-circuit operation should be verified to ensure that the absolute maximum rating of FB/VO is not exceeded.

Detailed Description of Hardware

The MAX17501B/MAX17501F EV kits provide proven designs to evaluate the MAX17501B/MAX17501F high-efficiency, high-voltage, synchronous step-down DC-DC converters. The EV kits generate a fixed 5V, at load currents up to 500mA, from a 6V to 60V input supply. The EV kits feature a 600kHz fixed switching frequency for optimum efficiency and component size. The MAX17501B EV kit supports a PFM control scheme with high light-load efficiency, while the MAX17501F EV kit features a forced-PWM control scheme that provides constant switching-frequency operation at all load and line conditions.

The EV kits include an EN/UVLO PCB pad and jumper JU1 to enable control of the converter output. An additional $\overline{\text{RESET}}$ PCB pad is available for monitoring the converter output. The VCC PCB pad helps measure the internal LDO voltage.

Soft-Start Input (SS)

The devices utilize an adjustable soft-start function to limit inrush current during startup. The soft-start time is adjusted by the value of C3, the external capacitor from SS to GND. To adjust the soft-start time, determine C3 using the following formula:

$$C3 = 5.55 \times t_{SS}$$

where t_{SS} is the required soft-start time in milliseconds and C3 is in nanofarads.

Regulator Enable/Undervoltage-Lockout Level (EN/UVLO)

The devices feature an EN/UVLO input. For normal operation, a shunt should be installed across pins 1-2 on jumper JU1. To disable the output, install a shunt across pins 2-3 on JU1 and the EN/UVLO pin is pulled to GND. See Table 1 for JU1 settings.

Setting the Undervoltage-Lockout Level

The devices offer an adjustable input undervoltage-lockout level. Set the voltage at which the device turns on with a resistive voltage-divider connected from VIN to GND. Connect the center node of the divider to EN/UVLO.

Choose R1 to be 3.3M Ω and then calculate R2 as follows:

$$R2 = \frac{R1 \times 1.218}{(V_{INU} - 1.218)}$$

where V_{INU} is the voltage at which the IC is required to turn on.

Table 1. Regulator Enable (EN/UVLO) Jumper JU1 Settings

SHUNT POSITION	EN/UVLO PIN	MAX17501_ OUTPUT
1-2*	Connected to IN	Enabled
Not installed	Connected to the center node of resistor-divider R1 and R2	Enabled, UVLO level set through the R1 and R2 resistor-divider
2-3	Connected to GND	Disabled

*Default position.

MAX17501B/MAX17501F Evaluation Kits

Evaluate: MAX17501B/MAX17501F in TDFN Packages

EV Kits Performance Report

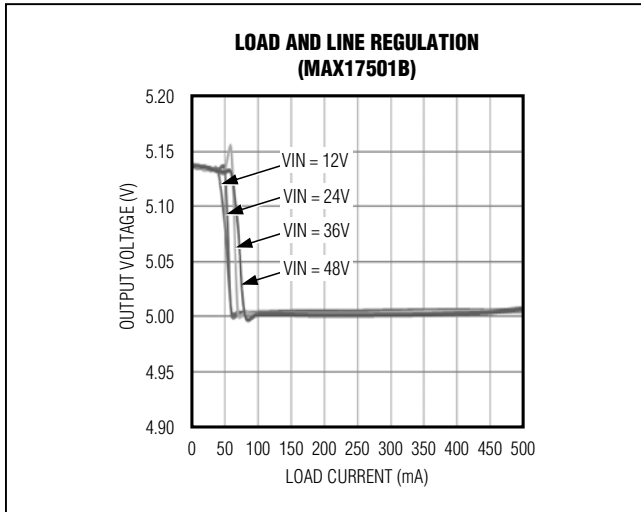

Figure 1. MAX17501B Load and Line Regulation

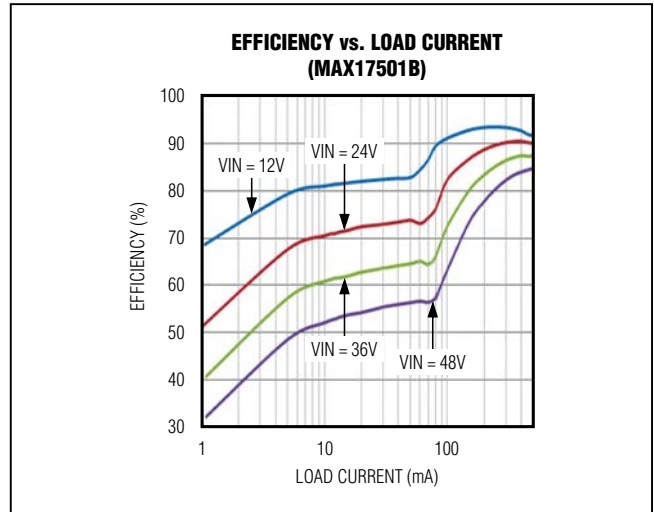

Figure 3. MAX17501B Efficiency

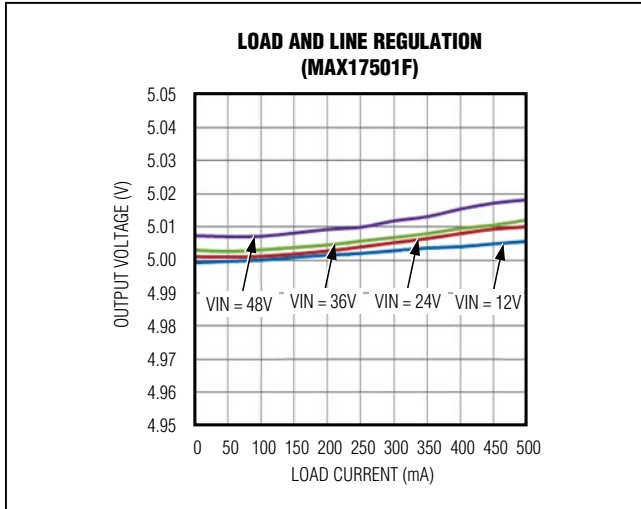

Figure 2. MAX17501F Load and Line Regulation

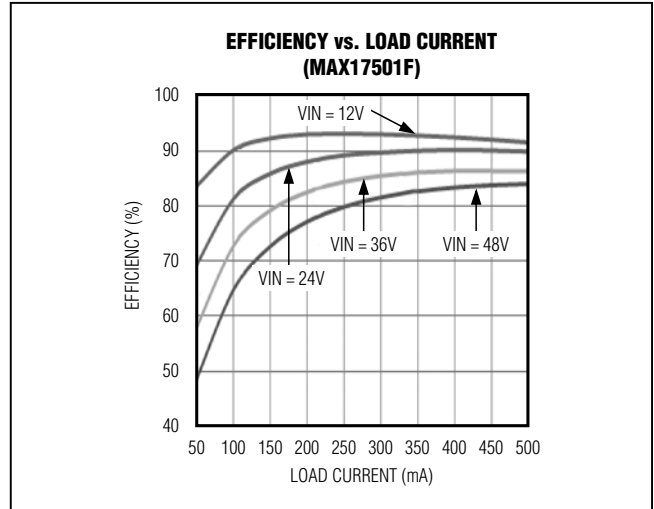

Figure 4. MAX17501F Efficiency

MAX17501B/MAX17501F Evaluation Kits

Evaluate: MAX17501B/MAX17501F in TDFN Packages

EV Kits Performance Report (continued)

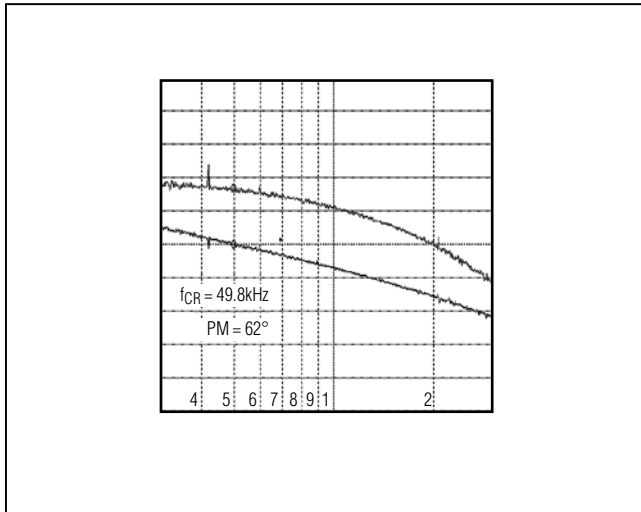

Figure 5. MAX17501B/MAX17501F Full-Load Bode Plot (VIN = 24V)

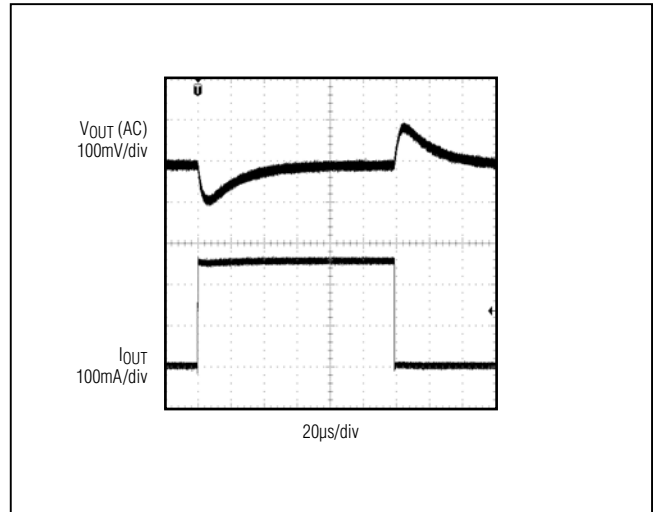

Figure 7. MAX17501F No Load to 250mA Load Transient

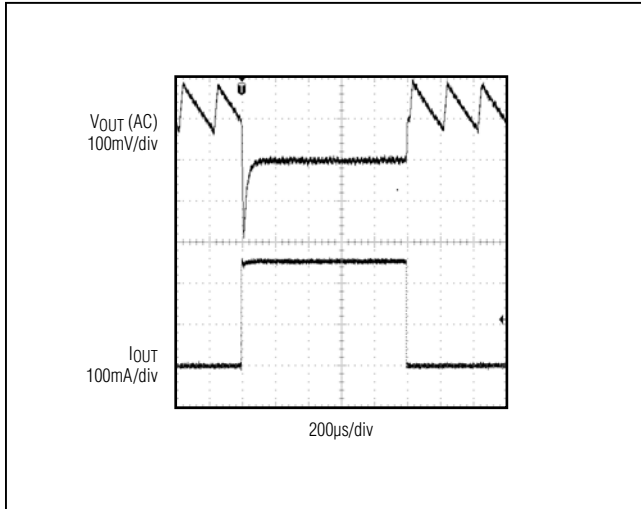

Figure 6. MAX17501B 5mA to 255mA Load Transient

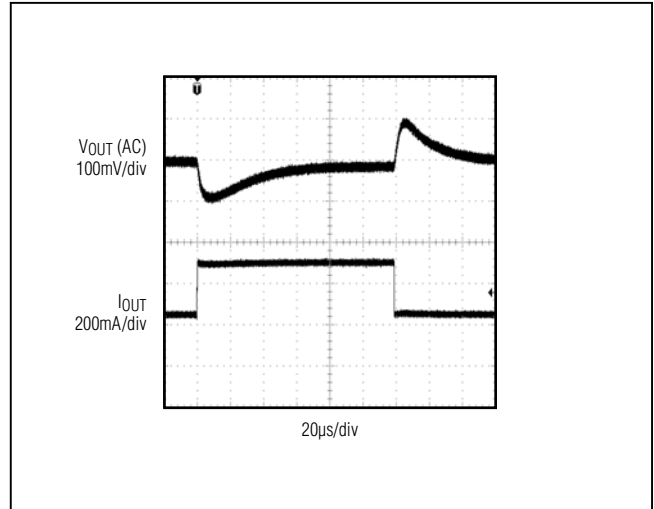

Figure 8. MAX17501B/MAX17501F 250mA to 500mA Load Transient

MAX17501B/MAX17501F Evaluation Kits

Evaluate: MAX17501B/MAX17501F in TDFN Packages

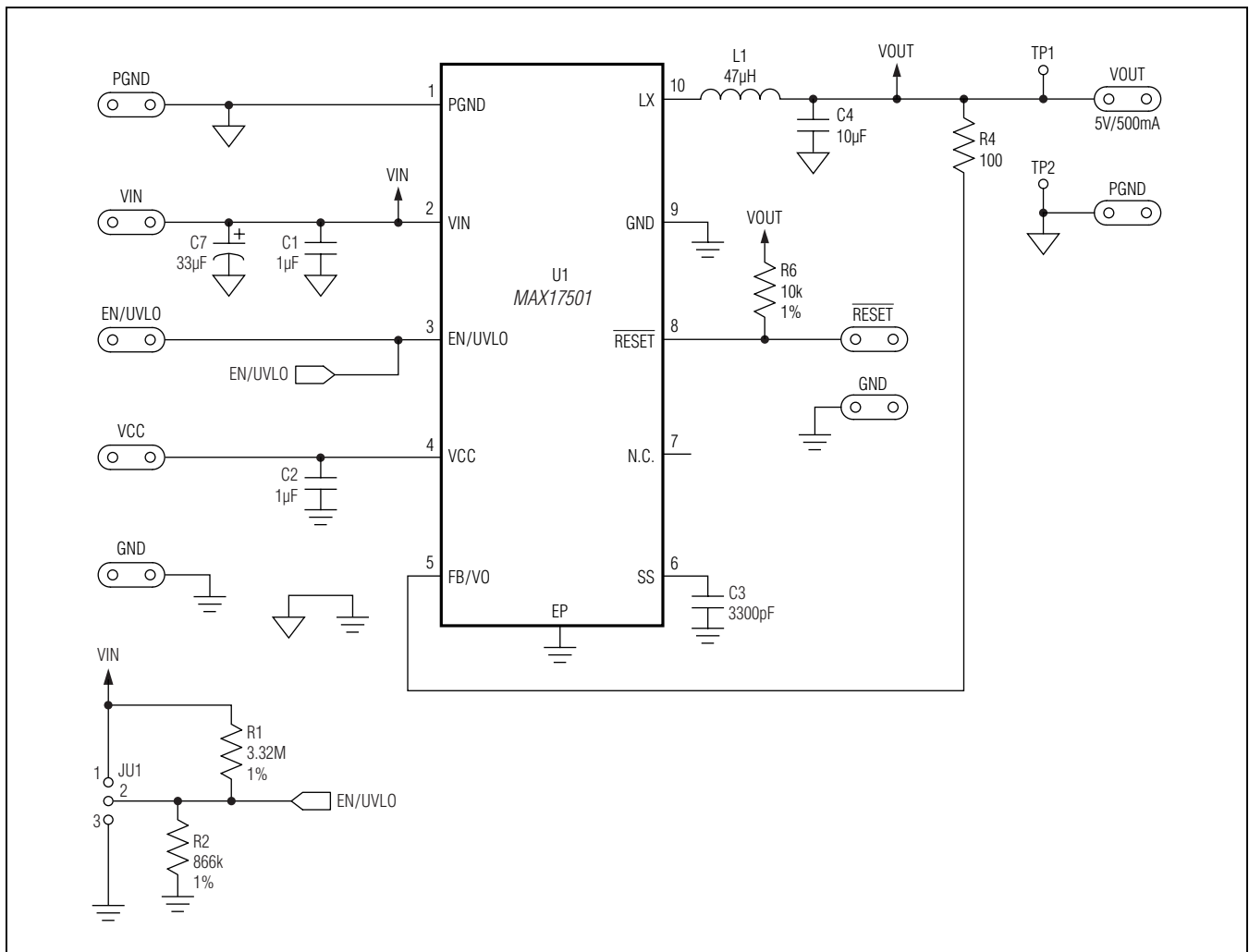

Figure 9. MAX17501B/MAX17501F EV Kits Schematic

MAX17501B/MAX17501F Evaluation Kits

Evaluate: MAX17501B/MAX17501F in TDFN Packages

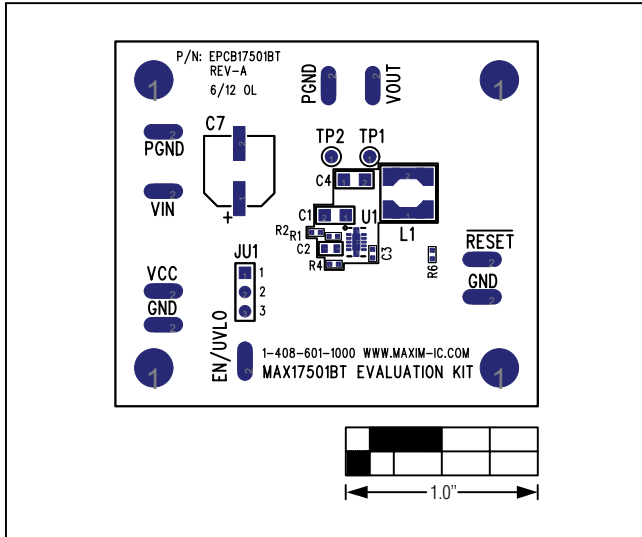

Figure 10. MAX17501B EV Kit Component Placement Guide—Component Side

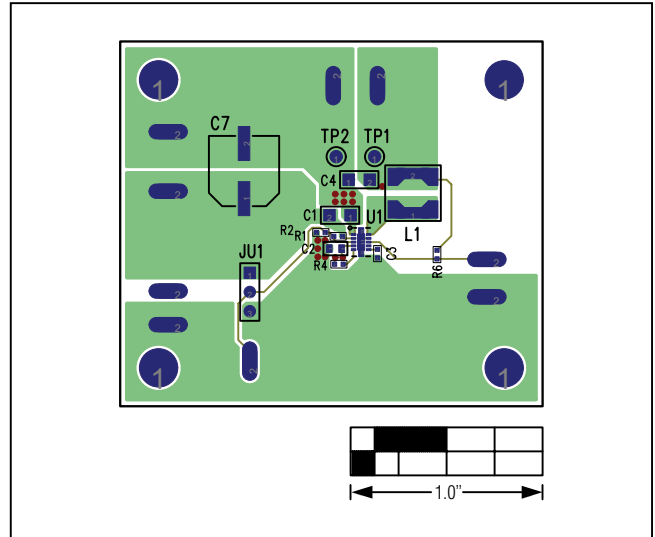

Figure 12. MAX17501B/MAX17501F EV Kits PCB Layout—Component Side

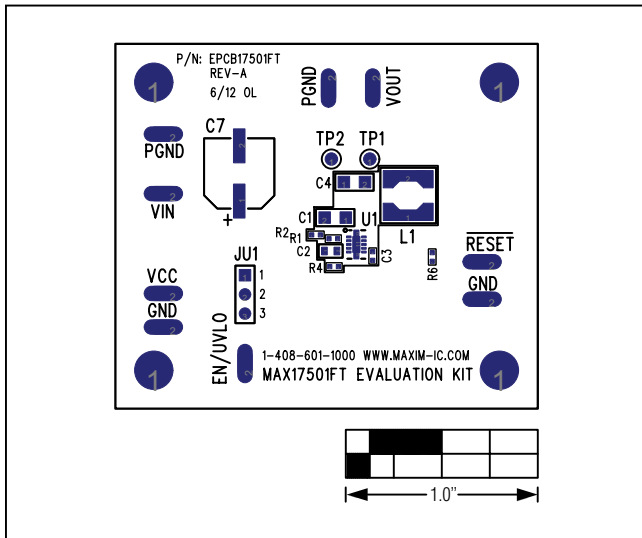

Figure 11. MAX17501F EV Kit Component Placement Guide—Component Side

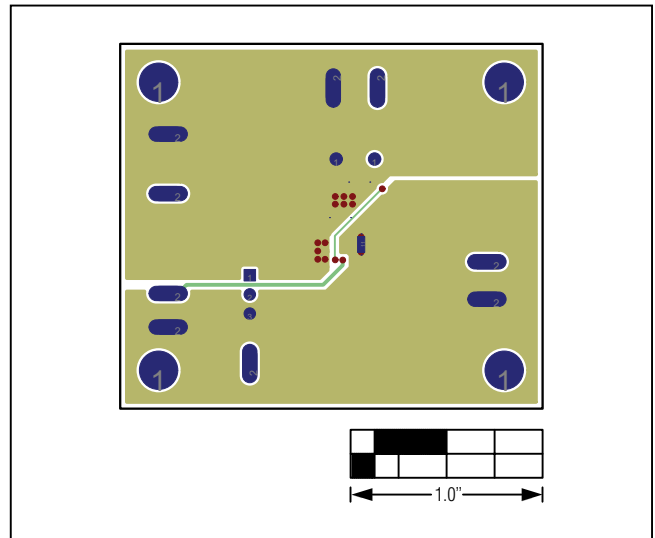

Figure 13. MAX17501B/MAX17501F EV Kits PCB Layout—Solder Side

MAX17501B/MAX17501F Evaluation Kits

Evaluate: MAX17501B/MAX17501F in TDFN Packages

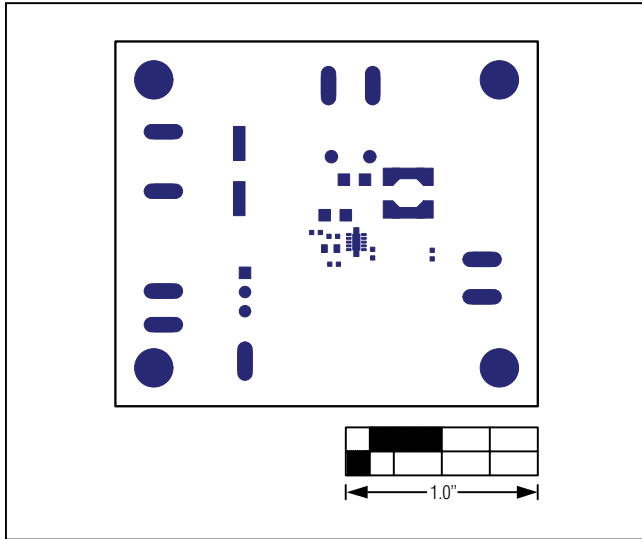

Figure 14. MAX17501B/MAX17501F EV Kits PCB Layout—Top Solder Mask

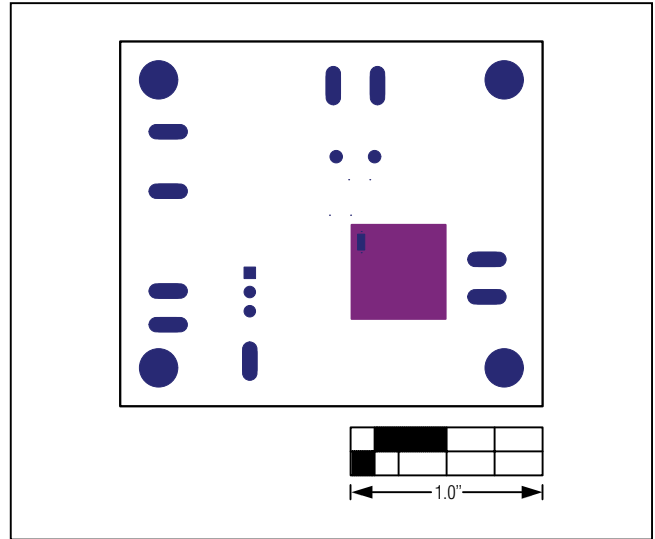

Figure 15. MAX17501B/MAX17501F EV Kits PCB Layout—Bottom Solder Mask

MAX17501B/MAX17501F Evaluation Kits

Evaluate: MAX17501B/MAX17501F in TDFN Packages

Ordering Information

PART	TYPE
MAX17501BTEVKIT#	EV Kit
MAX17501FTEVKIT#	EV Kit

#Denotes RoHS compliant.

MAX17501B/MAX17501F Evaluation Kits

Evaluate: MAX17501B/MAX17501F in TDFN Packages

Revision History

REVISION NUMBER	REVISION DATE	DESCRIPTION	PAGES CHANGED
0	8/12	Initial release	—
1	10/13	Replaced the R4 resistor value from 0Ω to 100Ω in the <i>Component List</i> and Figure 9 schematic; added new paragraph to the <i>Procedure</i> section about preventing violation of the abs max rating for FB/VO	1, 2, 6



Maxim Integrated cannot assume responsibility for use of any circuitry other than circuitry entirely embodied in a Maxim Integrated product. No circuit patent licenses are implied. Maxim Integrated reserves the right to change the circuitry and specifications without notice at any time. The parametric values (min and max limits) shown in the Electrical Characteristics table are guaranteed. Other parametric values quoted in this data sheet are provided for guidance.

Maxim Integrated 160 Rio Robles, San Jose, CA 95134 USA 1-408-601-1000

10

X-ON Electronics

Largest Supplier of Electrical and Electronic Components

Click to view similar products for [Power Management IC Development Tools](#) category:

Click to view products by [Maxim](#) manufacturer:

Other Similar products are found below :

[EVB-EP5348UI](#) [MIC23451-AAAYFL EV](#) [MIC5281YMME EV](#) [124352-HMC860LP3E](#) [DA9063-EVAL](#) [ADP122-3.3-EVALZ](#) [ADP130-0.8-EVALZ](#) [ADP130-1.8-EVALZ](#) [ADP1740-1.5-EVALZ](#) [ADP1870-0.3-EVALZ](#) [ADP1874-0.3-EVALZ](#) [ADP199CB-EVALZ](#) [ADP2102-1.25-EVALZ](#) [ADP2102-1.875EVALZ](#) [ADP2102-1.8-EVALZ](#) [ADP2102-2-EVALZ](#) [ADP2102-3-EVALZ](#) [ADP2102-4-EVALZ](#) [AS3606-DB](#) [BQ25010EVM](#) [BQ3055EVM](#) [ISLUSBI2CKIT1Z](#) [LP38512TS-1.8EV](#) [EVAL-ADM1186-1MBZ](#) [EVAL-ADM1186-2MBZ](#) [ADP122UJZ-REDYKIT](#) [ADP166Z-REDYKIT](#) [ADP170-1.8-EVALZ](#) [ADP171-EVALZ](#) [ADP1853-EVALZ](#) [ADP1873-0.3-EVALZ](#) [ADP198CP-EVALZ](#) [ADP2102-1.0-EVALZ](#) [ADP2102-1-EVALZ](#) [ADP2107-1.8-EVALZ](#) [ADP5020CP-EVALZ](#) [CC-ACC-DBMX-51](#) [ATPL230A-EK](#) [MIC23250-S4YMT EV](#) [MIC26603YJL EV](#) [MIC33050-SYHL EV](#) [TPS60100EVM-131](#) [TPS65010EVM-230](#) [TPS71933-28EVM-213](#) [TPS72728YFFEVM-407](#) [TPS79318YEQEVM](#) [UCC28810EVM-002](#) [XILINXPWR-083](#) [LMR22007YMINI-EVM](#) [LP38501ATJ-EV](#)