

MAX17503EVKITBE# Evaluation Kit

Evaluates: MAX17503 in 5V Output-Voltage Application

General Description

The MAX17503EVKITBE# evaluation kit (EV kit) provides a proven design to evaluate the MAX17503 high-voltage, high-efficiency, synchronous step-down DC-DC converter. The EV kit is preset for 5V output at load currents up to 2.5A and features a 500kHz switching frequency for optimum efficiency and component size. The EV kit features adjustable input undervoltage lockout, adjustable soft-start, open-drain $\overline{\text{RESET}}$ signal, and external clock synchronization. The EV kit also provides a good layout example which is optimized for conducted, radiated EMI, and thermal performance. For more details about the IC benefits and features, refer to the MAX17503 IC data sheet.

Features

- Operates from a 6.5V to 60V Input Supply
- Programmed 5V Output Voltage, 2.5A Load Current
- 500kHz Switching Frequency
- Enable/UVLO Input, Resistor-Programmable UVLO Threshold
- Adjustable Soft-Start Time
- MODE Pin to Select Among PWM, PFM, or DCM Modes
- Open-Drain $\overline{\text{RESET}}$ Output
- External Clock Synchronization
- Overcurrent and Overtemperature Protection
- Proven PCB Layout
- Fully Assembled and Tested
- Complies with CISPR22(EN55022) Class B Conducted and Radiated Emissions

Ordering Information appears at end of data sheet.

Quick Start

Recommended Equipment

- MAX17503EVKITBE#
- 6.5V to 60V, 5A DC input power supply
- Load capable of sinking 2.5A
- Digital voltmeter (DVM)

Equipment Setup and Test Procedure

The EV kit is fully assembled and tested. Follow the steps below to verify the board operation.

Caution: Do not turn on power supply until all connections are completed.

- 1) Set the power supply at a voltage between 6.5V and 60V. Disable the power supply.
- 2) Connect the positive terminal of the power supply to the VIN PCB pad and the negative terminal to the nearest PGND PCB pad. Connect the positive terminal of the 2.5A load to the VOUT PCB pad and the negative terminal to the nearest PGND PCB pad.
- 3) Connect the DVM across the VOUT PCB pad and the nearest PGND PCB pad.
- 4) Verify that shunts are installed across pins 1-2 on jumper JU1 and pins 2-3 on jumper JU3 (see Tables 1 and 3 for details).
- 5) Select the shunt position on jumper JU2 according to the intended mode of operation (see [Table 2](#) for details).
- 6) Turn on the DC power supply.
- 7) Enable the load.
- 8) Verify that the DVM displays 5V.

Detailed Description

The MAX17503EVKITBE# provides a proven design to evaluate the MAX17503 high-voltage, high-efficiency, synchronous step-down DC-DC converter. The EV kit is preset for 5V output from 6.5V to 60V input at load currents up to 2.5A and features a 500kHz switching frequency for optimum efficiency and component size.

The EV kit includes an EN/UVLO PCB pad and jumper JU1 to enable the output at a desired input voltage. The SYNC PCB pad and jumper JU3 allow an external clock to synchronize the device. Jumper JU2 allows the selection of a particular mode of operation based on light-load performance requirements. An additional RESET PCB pad is available for monitoring whether the converter output is in regulation.

Soft-Start Input (SS)

The EV kit offers an adjustable soft-start function to limit inrush current during startup. The soft-start time is adjusted by the value of external soft-start capacitor (C10) connected between SS and SGND. The selected output capacitance (C_{SEL}) and the output voltage (V_{OUT}) determine the minimum value of C10, as shown by the following equation:

$$C10 \geq 28 \times 10^{-6} \times C_{SEL} \times V_{OUT}$$

The soft-start time (t_{SS}) is related to C10 by the following equation:

$$t_{SS} = C10 / (5.55 \times 10^{-6})$$

For example, to program a 1ms soft-start time, C10 should be 5.6nF.

Enable/Undervoltage-Lockout (EN/UVLO) Programming

The MAX17503 offers an Enable and adjustable input undervoltage lockout feature. In this EV kit, for normal operation, leave the EN/UVLO jumper (JU1) open. When JU1 is left open, the MAX17503 is enabled when the input voltage rises above 6.4V. To disable the MAX17503, install a jumper across pins 2–3 on JU1. See [Table 1](#) for JU1 settings. The EN/UVLO PCB pad on the EV kit supports external Enable/Disable control of the device. Leave JU1 open when external Enable/Disable control is desired. A potential divider formed by R1 and R2 sets the input voltage (V_{INU}) above which the converter is enabled when JU1 is left open.

Choose R1 to be 3.32MΩ (max), and then calculate R2 as follows:

$$R_2 = \frac{R_1 \times 1.215}{(V_{INU} - 1.215)}$$

where, V_{INU} is the voltage at which the device is required to turn on, and R1 and R2 are in kΩ.

For more details about setting the undervoltage lockout level, refer to the MAX17503 data sheet.

Mode Selection (MODE)

The EV kit provides a jumper (JU2) that allows the MAX17503 to operate in PWM, PFM, and DCM modes. Refer to the MAX17503 data sheet for more details on the modes of operation.

[Table 2](#) shows the mode selection (JU2) settings that can be used to configure the desired mode of operation.

Table 1. Converter EN/UVLO Jumper (JU1) Settings

SHUNT POSITION	EN/UVLO PIN	MAX17503 OUTPUT
1-2*	Connected to VIN	Enabled
Not installed	Connected to the center node of resistor-divider R1 and R2	Enabled, UVLO level set through the R1 and R2 resistors
2-3	Connected to SGND	Disabled

*Default position.

Table 2. Mode Selection (JU2) Settings

SHUNT POSITION	MODE PIN	MAX17503 MODE
Not installed*	Unconnected	PFM mode of operation
2-3	Connected to SGND	PWM mode of operation
1-2	Connected to VCC	DCM mode of operation

*Default position.

External Clock Synchronization (SYNC)

The EV kit provides a SYNC PCB pad to synchronize the MAX17503 to an optional external clock. Leave Jumper (JU3) open when external clock signals are applied. In the presence of a valid external clock for synchronization, the MAX17503 operates in PWM mode only. For more details about external clock synchronization, refer to the MAX17503 data sheet.

Active-Low, Open-Drain Reset Output (RESET)

The EV kit provides a RESET PCB pad to monitor the status of the converter. RESET goes high when VOUT rises above 95% (typ) of its nominal regulated output voltage. RESET goes low when VOUT falls below 92% (typ) of its nominal regulated voltage.

Table 3. External Clock Synchronization (JU3) Settings

SHUNT POSITION	SYNC PIN	MAX17503 SYNC
1-2	Connected to test loop on PCB	Frequency can be synchronized with an external clock
2-3*	Connected to SGND	SYNC feature unused

*Default position.

Hot Plug-In and Long Input Cables

The MAX17503EVKITBE# PCB layout provides an optional electrolytic capacitor (CIN4 = 68µF/100V). This capacitor limits the peak voltage at the input of the MAX17503 when the DC input source is “Hot-Plugged” to the EV kit input terminals with long input cables. The equivalent series resistance (ESR) of the electrolytic capacitor dampens the oscillations caused by interaction of the inductance of the long input cables, and the ceramic capacitors at the buck converter input.

Electromagnetic Interference (EMI)

Compliance to conducted emissions (CE) standards requires an EMI filter at the input of a switching power converter. The EMI filter attenuates high-frequency currents drawn by the switching power converter and limits the noise injected back into the input power source.

The MAX17503EVKITBE# PCB has designated footprints on the bottom side for placement of EMI filter components. Use of these filter components results in lower conducted emissions below CISPR22 Class B limits. Remove the 0Ω resistor which is placed on the L1 footprint before installing conducted EMI filter components. The MAX17503EVKITBE# EV kit PCB layout is also designed to limit radiated emissions from switching nodes of the power converter, resulting in radiated emissions below CISPR22 Class B limits.

Component Suppliers

SUPPLIER	WEBSITE
Vishay Dale	www.vishay.com
Coilcraft, Inc.	www.coilcraft.com
Murata Americas	www.murata.com
Panasonic Corp.	www.panasonic.com
SullinsCorp	www.sullinscorp.com
Taiyo Yuden	www.ty-top.com

Note: Indicate that you are using the MAX17503 when contacting these component suppliers.

Ordering Information

PART	TYPE
MAX17503EVKITBE#	EV Kit

#Denotes RoHS compliant.

EV Kit Test Report

($V_{IN} = 24V$, $V_{OUT} = 5V$, $I_{OUT} = 2.5A$, $f_{SW} = 500kHz$, $T_A = +25^{\circ}C$, unless otherwise noted.)

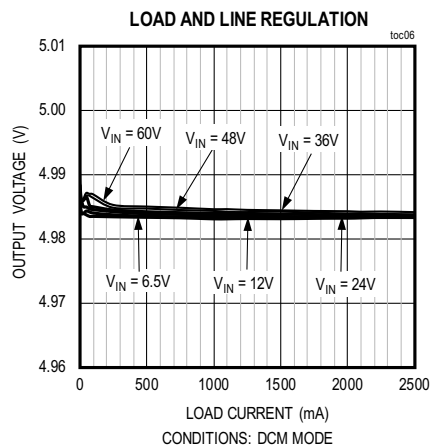
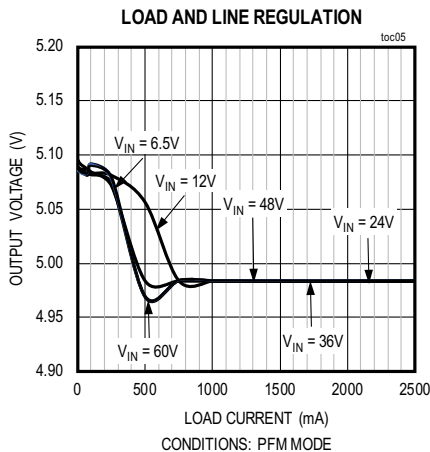
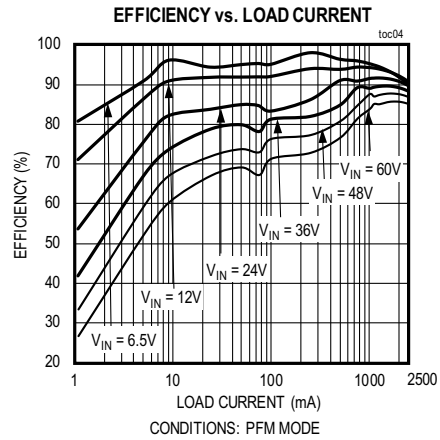
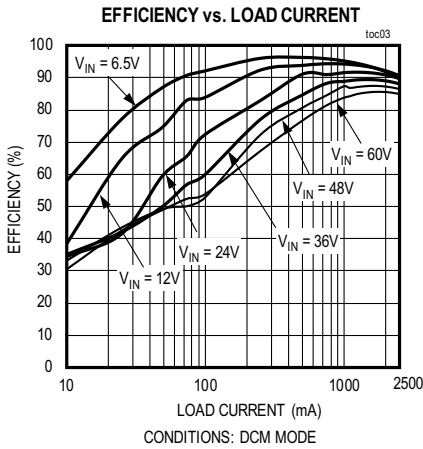
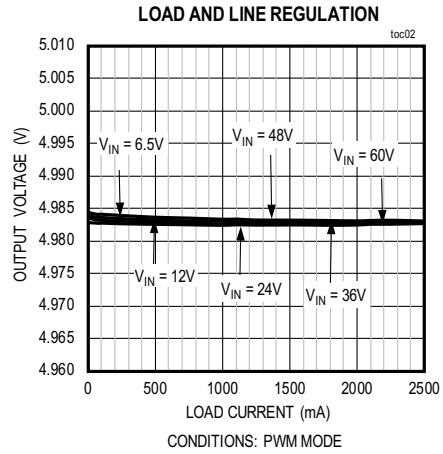
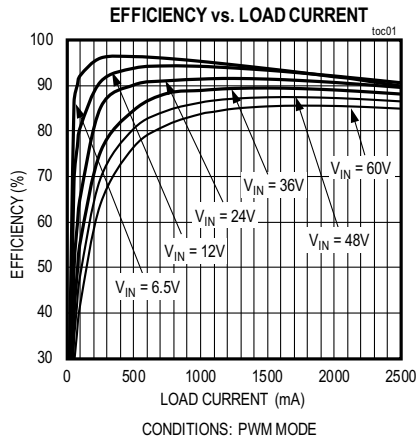

EV Kit Test Report (continued)

($V_{IN} = 24V$, $V_{OUT} = 5V$, $I_{OUT} = 2.5A$, $f_{SW} = 500kHz$, $T_A = +25^{\circ}C$, unless otherwise noted.)

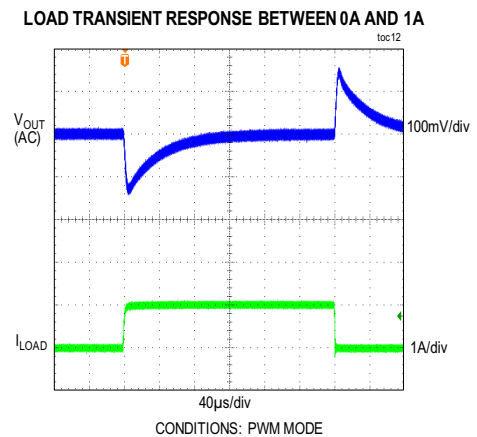
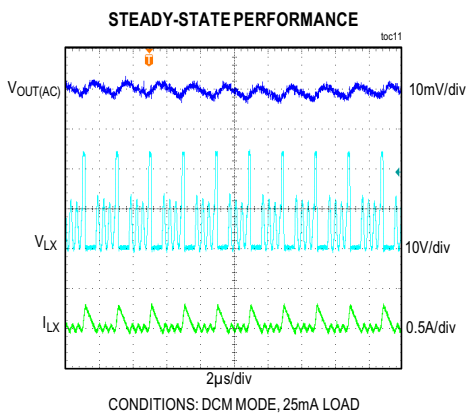
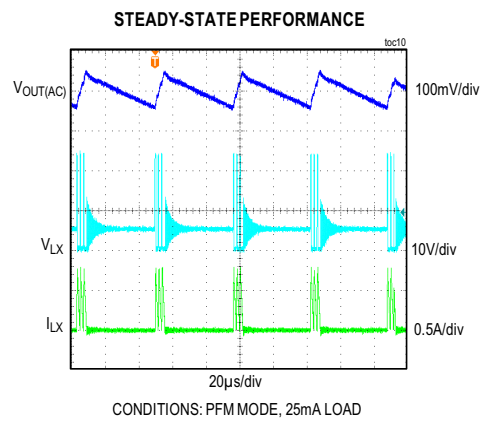
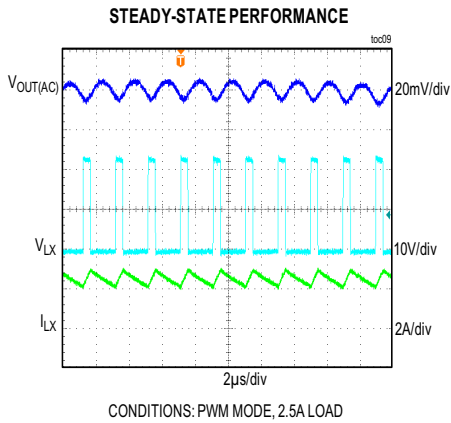
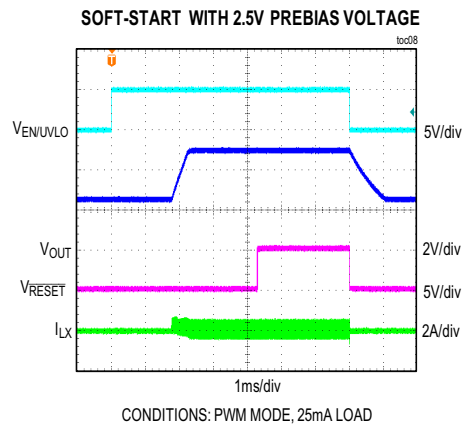
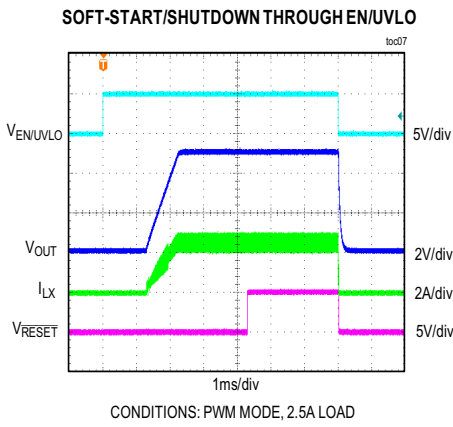

EV Kit Test Report (continued)

($V_{IN} = 24V$, $V_{OUT} = 5V$, $I_{OUT} = 2.5A$, $f_{SW} = 500kHz$, $T_A = +25^{\circ}C$, unless otherwise noted.)

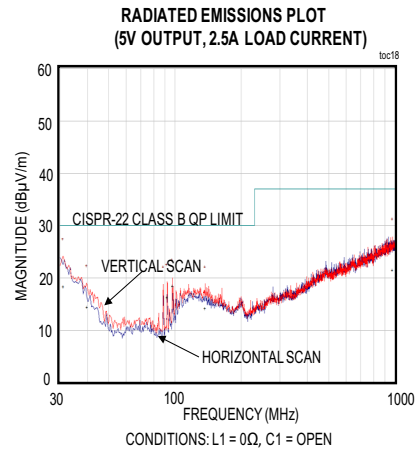
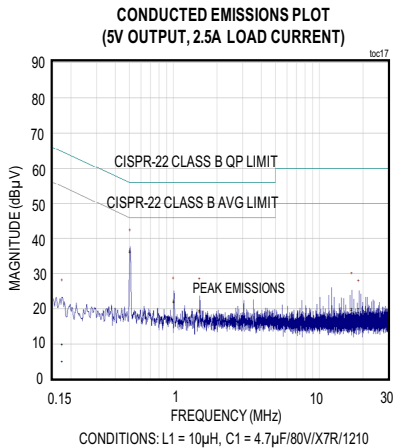
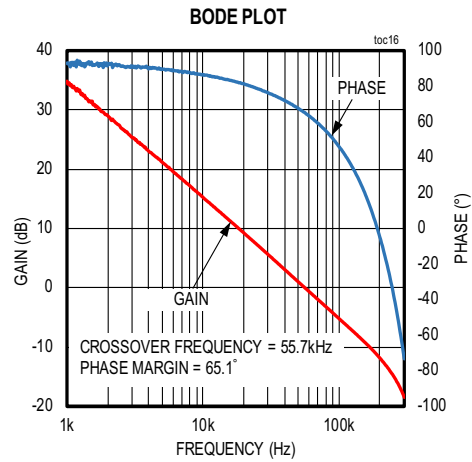
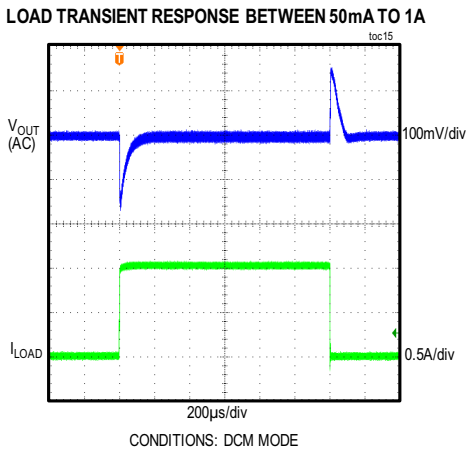
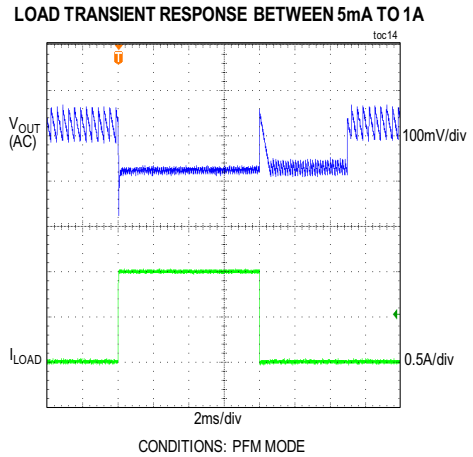
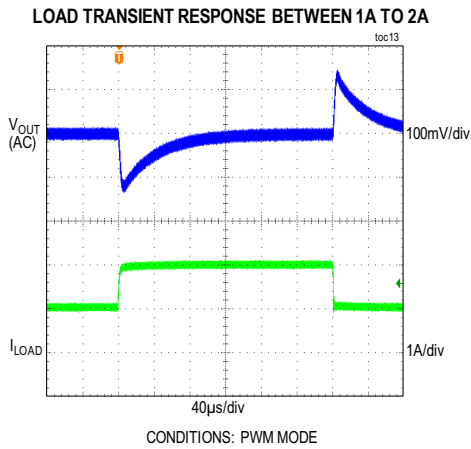

MAX17503EVKITBE# Bill of Materials

S. No	DESIGNATOR	DESCRIPTION	QUANTITY	MANUFACTURER PART NUMBER
1	CIN1, CIN7	0.1 μ F, 10%, 100V, X7R, Ceramic capacitor (0603)	2	TAIYO YUDEN HMK107B7104KA-T
2	CIN2, CIN3	4.7 μ F, 10%, 80V, X7R, Ceramic capacitor (1210)	2	MURATA GRM32ER71K475KE14
3	CIN4	ALUMINUM-ELECTROLYTIC; 68UF; 100V; TOL=20%; MODEL = EEV SERIES	1	PANASONIC EEV-FK2A680Q
4	CIN5	0.47 μ F, 10%, 100V, X7R, Ceramic capacitor (0805)	1	MURATA GRM21BR72A474KA73
5	CIN6	220pF, 5%, 100V, COG, Ceramic capacitor (0603)	1	TDK C1608C0G2A221J080AA
6	C8	2.2 μ F, 10%, 10V, X7R, Ceramic capacitor (0603)	1	MURATA GRM188R71A225KE15
7	C10	5600pF, 2%, 50V, COG, Ceramic capacitor (0402)	1	MURTA GRM1555C1H562GE01
8	CO1	22 μ F, 10%, 25V, X7R, Ceramic capacitor (1210)	1	MURATA GRM32ER71E226ME15
9	C7, CO6, CO7	0.1 μ F, 10%, 16V, X7R, Ceramic capacitor (0402)	3	TAIYO YUDEN EMK105B7104KV-F
10	CO9	2.2 μ F, 10%, 10V, X7R, Ceramic capacitor (0603)	1	MURATA GRM188R71A225KE15
11	L1	RES+, 0 Ω , 1W (1812)	1	VISHAY RCA12180000Z0EKLS
12	L3	INDUCTOR, 10 μ H, 4.7A (10mm x 10mm)	1	COILCRAFT MSS1048-103ML
13	R1	RES+, 3.32M Ω , 1% (0402)	1	VISHAY DALE CRCW04023M32FK
14	R2	RES+, 787K Ω , 1% (0402)	1	VISHAY DALE CRCW0402787KFK
15	R4	RES+, 178K Ω , 1% (0402)	1	BOURNS CR0402-FX-1783GLF
16	R5	RES+, 10K Ω , 1% (0402)	1	VISHAY DALE CRCW040210K0FK
17	R6	RES+, 39K Ω , 1% (0402)	1	VISHAY DALE CRCW040239K0FK
18	U1	HIGH-EFFICIENCY; SYNCHRONOUS STEP-DOWN DC-DC CONVERTER; (TQFN20-EP 4mm x 4mm)	1	MAX17503ATP+
19	JU1-JU3	3-pin header (36-pin header 0.1" centers)	3	Sullins: PEC03SAAN
20	-	Shunts	3	SULLINS STC02SYAN
21	MH1-MH4	MACHINE SCREW; SLOTTED	4	EAGLE PLASTIC DEVICES P440.375
22	MH1-MH4	HEX STANDOFF #4-40 NYLON 3/8"	4	KEYSTONE ELECTRONICS 1902B
23	C1	OPTIONAL: 4.7 μ F, 10%, 80V, X7R, Ceramic capacitor (1210)	1	MURATA GRM32ER71K475KE14
24	L1	OPTIONAL: INDUCTOR, 10 μ H, 3.1A (4mm x 4mm)	1	COILCRAFT XAL4040-103ME
25	CO2	OPEN: Capacitor (1210)	0	
26	CO3, CO4, CO5	OPEN: Capacitor (0805)	0	
27	CO8	OPEN: Capacitor (0603)	0	
28	C11	OPEN: Capacitor (0402)	0	
29	R3	OPEN: Resistor (0402)	0	

DEFAULT JUMPER TABLE	
JUMPER	SHUNT POSITION
JU1	1-2
JU2	1
JU3	2-3

MAX17503EVKITBE# Schematic

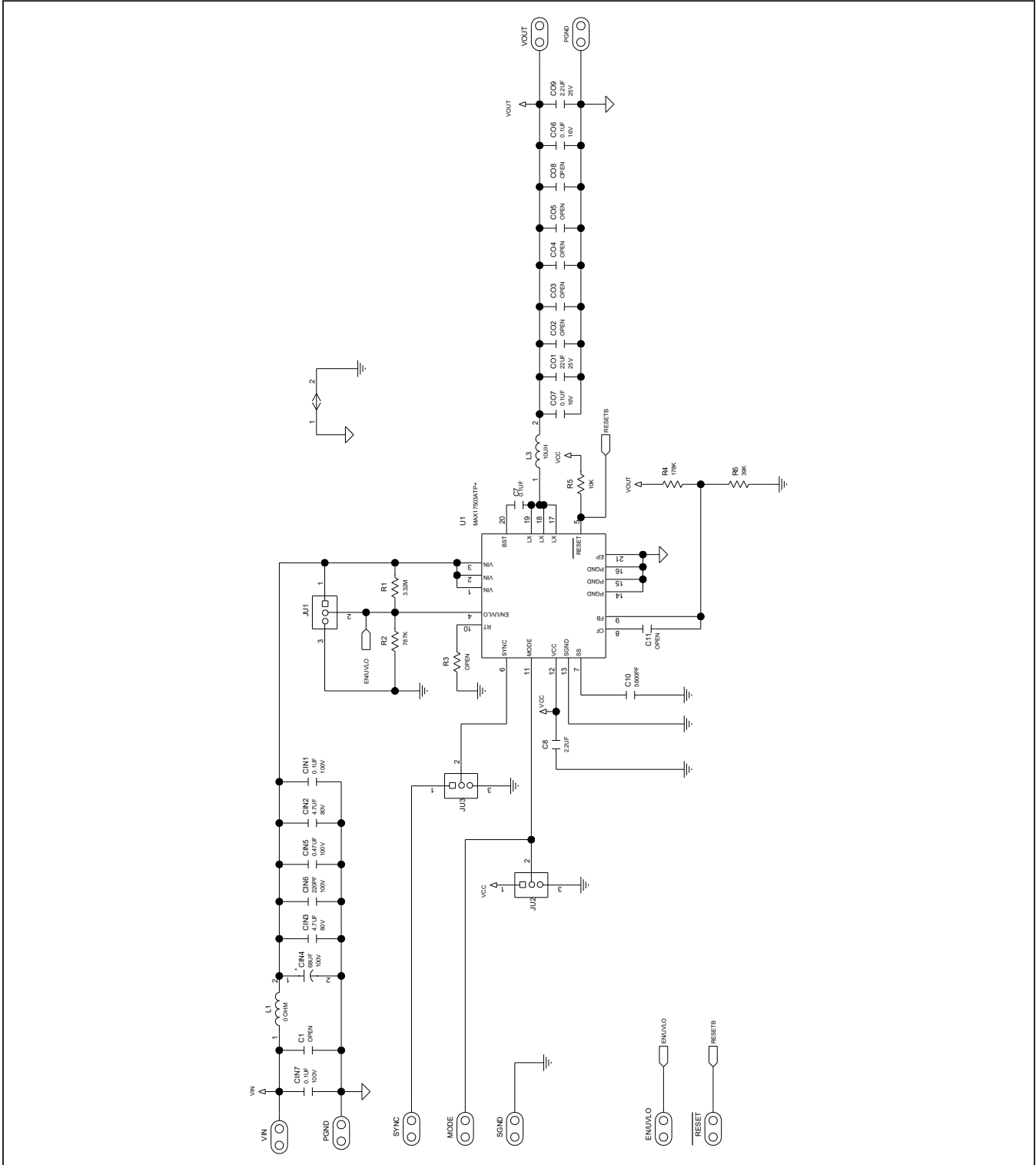

MAX17503EVKITBE# Evaluation Kit

Evaluates: MAX17503 in
5V Output-Voltage Application

MAX17503EVKITBE# PCB Layout

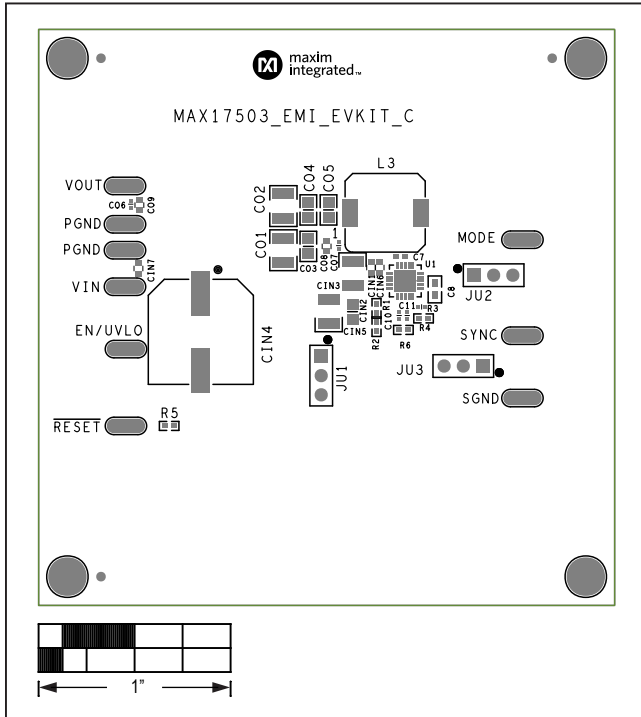

MAX17503EVKITBE# PCB Layout—Top Silkscreen

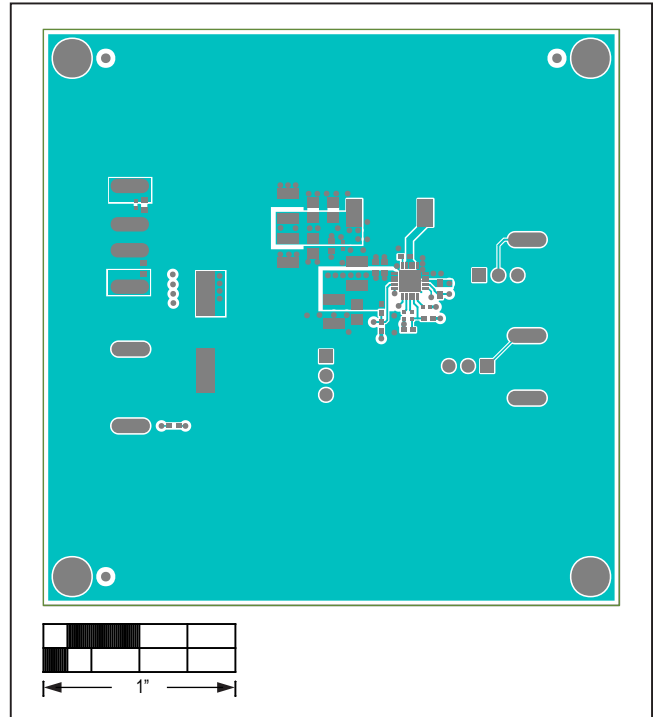

MAX17503EVKITBE# PCB Layout—Top Layer

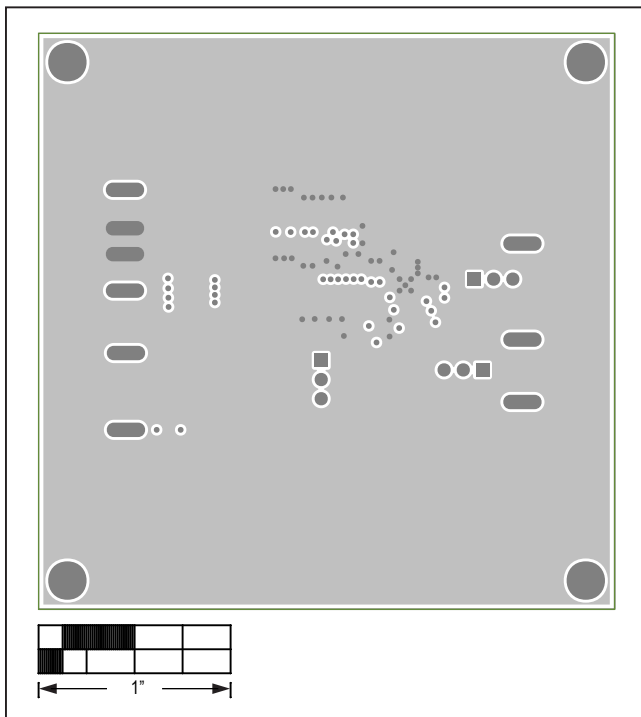

MAX17503EVKITBE# PCB Layout—Layer 2

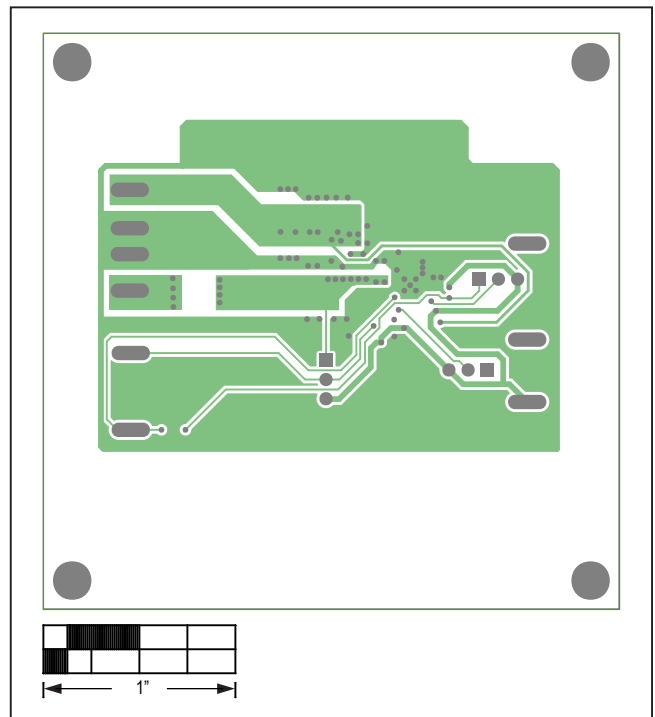

MAX17503EVKITBE# PCB Layout—Layer 3

MAX17503EVKITBE# PCB Layout (Continued)

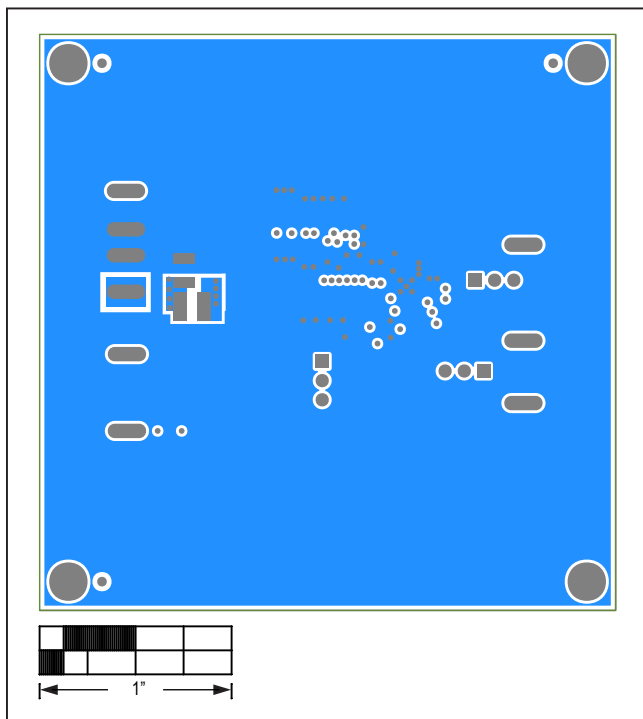

MAX17503EVKITBE# PCB Layout—Bottom Layer

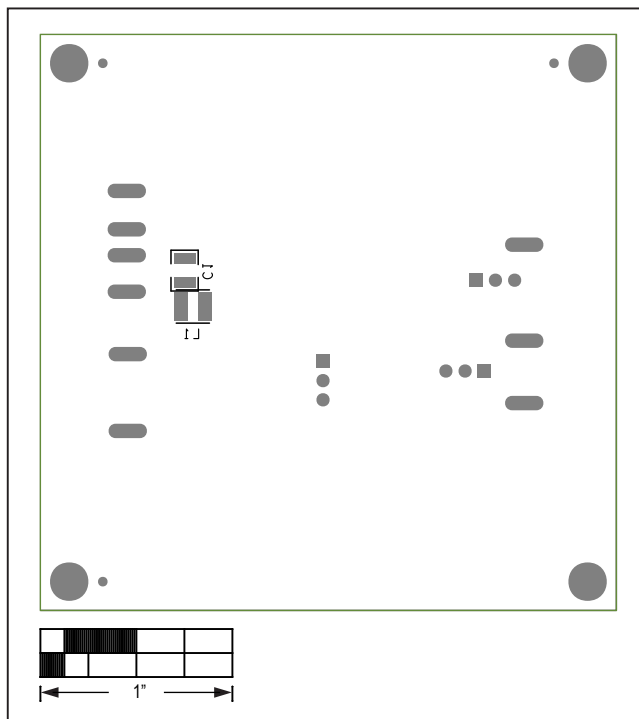

MAX17503EVKITBE# PCB Layout—Bottom Silkscreen

Revision History

REVISION NUMBER	REVISION DATE	DESCRIPTION	PAGES CHANGED
0	4/19	Initial release	—

For pricing, delivery, and ordering information, please visit Maxim Integrated's online storefront at <https://www.maximintegrated.com/en/storefront/storefront.html>.

Maxim Integrated cannot assume responsibility for use of any circuitry other than circuitry entirely embodied in a Maxim Integrated product. No circuit patent licenses are implied. Maxim Integrated reserves the right to change the circuitry and specifications without notice at any time.

X-ON Electronics

Largest Supplier of Electrical and Electronic Components

Click to view similar products for [Power Management IC Development Tools](#) category:

Click to view products by [Maxim](#) manufacturer:

Other Similar products are found below :

[EVB-EP5348UI](#) [MIC23451-AAAYFL EV](#) [MIC5281YMME EV](#) [124352-HMC860LP3E](#) [DA9063-EVAL](#) [ADP122-3.3-EVALZ](#) [ADP130-0.8-EVALZ](#) [ADP130-1.8-EVALZ](#) [ADP1740-1.5-EVALZ](#) [ADP1870-0.3-EVALZ](#) [ADP1874-0.3-EVALZ](#) [ADP199CB-EVALZ](#) [ADP2102-1.25-EVALZ](#) [ADP2102-1.875EVALZ](#) [ADP2102-1.8-EVALZ](#) [ADP2102-2-EVALZ](#) [ADP2102-3-EVALZ](#) [ADP2102-4-EVALZ](#) [AS3606-DB](#) [BQ25010EVM](#) [BQ3055EVM](#) [ISLUSBI2CKIT1Z](#) [LP38512TS-1.8EV](#) [EVAL-ADM1186-1MBZ](#) [EVAL-ADM1186-2MBZ](#) [ADP122UJZ-REDYKIT](#) [ADP166Z-REDYKIT](#) [ADP170-1.8-EVALZ](#) [ADP171-EVALZ](#) [ADP1853-EVALZ](#) [ADP1873-0.3-EVALZ](#) [ADP198CP-EVALZ](#) [ADP2102-1.0-EVALZ](#) [ADP2102-1-EVALZ](#) [ADP2107-1.8-EVALZ](#) [ADP5020CP-EVALZ](#) [CC-ACC-DBMX-51](#) [ATPL230A-EK](#) [MIC23250-S4YMT EV](#) [MIC26603YJL EV](#) [MIC33050-SYHL EV](#) [TPS60100EVM-131](#) [TPS65010EVM-230](#) [TPS71933-28EVM-213](#) [TPS72728YFFEVM-407](#) [TPS79318YEQEVM](#) [UCC28810EVM-002](#) [XILINXPWR-083](#) [LMR22007YMINI-EVM](#) [LP38501ATJ-EV](#)