

MAX17521 Evaluation Kit

Evaluates: MAX17521 in 3.3V and 5V Output-Voltage Application

General Description

The MAX17521 evaluation kit (EV kit) provides a proven design to evaluate the MAX17521 dual high-efficiency, high-voltage, synchronous step-down DC-DC converter. The EV kit generates 3.3V and 5V output voltages at load currents up to 1A from a 7V to 60V input supply. The EV kit features a switching-frequency selector pin and individual mode-of-operation selector pins, enable/under-voltage-lockout (EN/UVLO) pins, programmable soft-start pins, and open-drain $\overline{\text{RESET}}$ signals for each output.

Features

- Operates from a 7V to 60V Input Supply
- Dual-Output Voltage: 3.3V and 5V
- Up to 1A Output Current
- Pin-Selectable Switching Frequency
- Enable/UVLO Input, Resistor-Programmable UVLO Threshold
- Mode-Selection Pin for Each Output to Select Between PWM and PFM Modes
- Adjustable Soft-Start Time for Each Output
- Open-Drain $\overline{\text{RESET}}$ Signals for Each Output
- External Frequency Synchronization
- Overcurrent and Overtemperature Protection
- Proven PCB Layout
- Fully Assembled and Tested

Ordering Information appears at end of data sheet.

Quick Start

Recommended Equipment

- MAX17521 EV kit
- 7V to 60V, 2A DC input power supply
- Two loads capable of sinking 1A
- Two digital voltmeters (DVM)

Procedure

The EV kit is fully assembled and tested. Follow the steps below to verify the board operation. **Caution: Do not turn on the power supply until all connections are completed.**

- 1) Set the power supply at a voltage between 7V and 60V. Disable the power supply.
- 2) Connect the positive terminal of the power supply to the VIN PCB pad and the negative terminal to the nearest PGND1 PCB pad. Connect the positive terminal of one of the 1A loads to the VOUT1 PCB pad and the negative terminal to the PGND1 PCB pad. Connect the positive terminal of the other 1A load to the VOUT2 PCB pad and the negative terminal to the PGND2 PCB pad.
- 3) Connect the DVMs across the VOUT1 PCB pad and the PGND1 PCB pad and across the VOUT2 PCB pad and the PGND2 PCB pad.
- 4) Verify that shunts are installed across pins 1-2 on jumpers J1, J2, and J3.
- 5) Select the shunt position on J5 and J6 depending on the intended mode of operation.
- 6) Turn on the DC power supply.
- 7) Enable the loads.
- 8) Verify that the DVMs display 3.3V and 5V.

MAX17521 Evaluation Kit

Evaluates: MAX17521 in 3.3V and 5V Output-Voltage Application

Detailed Description

The MAX17521 EV kit provides a proven design to evaluate the MAX17521 high-efficiency, high-voltage, dual synchronous step-down DC-DC converter. The EV kit generates 3.3V and 5V, at load currents up to 1A, from a 7V to 60V input supply.

The EV kit features a switching-frequency selector pin and individual mode-of-operation selector pins, enable/undervoltage-lockout (EN/UVLO) pins, programmable soft-start pins, and open-drain RESET signals for each output.

Soft-Start Input (SS)

The device implements adjustable soft-start operation to reduce inrush current. Capacitors connected from the SS pins to SGND program the soft-start time for the corresponding output voltage. The selected output capacitance (C_{SEL}) and the output voltage (V_{OUT}) determine the minimum required soft-start capacitor as follows:

$$C_{SS} \geq 56 \times 10^{-6} \times C_{SEL} \times V_{OUT}$$

The soft-start time (t_{SS}) is related to the capacitor connected at SS (C_{SS}) by the following equation:

$$t_{SS} = C_{SS} / (5.55 \times 10^{-6})$$

For example, to program a 1ms soft-start time, a 5.6nF capacitor should be connected from the SS pin to SGND.

Table 1. Regulator Enable (EN/UVLO1) Description (J1)

| SHUNT POSITION | EN/UVLO1 PIN | MAX17521_ OUTPUT1 |
|----------------|--|---|
| 1-2* | Connected to VIN1 | Enabled |
| Not installed | Connected to the center node of resistor-divider R3 and R4 | Enabled, UVLO level set through the R3 and R4 resistors |
| 2-3 | Connected to SGND | Disabled |

*Default position.

Regulator Enable/Undervoltage-Lockout Level (EN/UVLO1, EN/UVLO2)

The device offers an adjustable input undervoltage-lockout level for each output. Set the voltage at which each converter turns on with a resistive voltage-divider connected from VIN to SGND (viewable [here](#)). Connect the center node of the divider to EN/UVLO pin.

Choose R_{TOP} to be 3.3M Ω , and then calculate R_{BOTTOM} as:

$$R_{BOTTOM} = \frac{R_{TOP} \times 1.218}{V_{INU} - 1.218}$$

Where V_{INU} is the input voltage at which a particular converter is required to turn on. Install a shunt across pins 1-2 on J1 and J2 to enable the EV kit's outputs. See [Table 1](#) and [Table 2](#) for proper jumper settings.

Table 2. Regulator Enable (EN/UVLO2) Description (J2)

| SHUNT POSITION | EN/UVLO2 PIN | MAX17521_ OUTPUT2 |
|----------------|--|---|
| 1-2* | Connected to VIN2 | Enabled |
| Not installed | Connected to the center node of resistor-divider R11 and R12 | Enabled, UVLO level set through the R11 and R12 resistors |
| 2-3 | Connected to SGND | Disabled |

*Default position.

MAX17521 Evaluation Kit

Evaluates: MAX17521 in 3.3V and 5V Output-Voltage Application

Mode Selection (MODE1, MODE2)

The device's MODE_ pins can be used to select between the PWM and PFM modes of operation. Refer to the MAX17521 IC data sheet for more information on the PWM and PFM modes of operation.

Table 3 and Table 4 show EV kit jumper settings that can be used to configure the desired mode of operation.

Switching-Frequency Selection (FSEL)

The device's FSEL pin can be used to select between 560kHz and 300kHz switching frequency. The EV kit is designed to operate at 560kHz switching frequency. If intended to operate at 300kHz, the values of the inductors, input and output capacitors, and the compensation components should be modified according to formulae provided in the MAX17521 IC data sheet.

Table 5 shows EV kit jumper settings that can be used to configure the switching frequency.

Table 3. MODE1 Description (J6)

| SHUNT POSITION | MODE1 PIN | MAX17521_ MODE1 |
|----------------|-------------------|-----------------------|
| Not installed* | Unconnected | PFM mode of operation |
| 1-2 | Connected to SGND | PWM mode of operation |

*Default position.

Table 4. MODE2 Description (J5)

| SHUNT POSITION | MODE2 PIN | MAX17521_ MODE2 |
|----------------|-------------------|-----------------------|
| Not installed* | Unconnected | PFM mode of operation |
| 1-2 | Connected to SGND | PWM mode of operation |

*Default position.

External Clock Synchronization (SYNC)

The internal oscillator of the device can be synchronized to an external clock signal on the SYNC pin. The external synchronization clock frequency must be between $1.1f_{SW}$ and $1.4f_{SW}$, where f_{SW} is the frequency of operation set by the FSEL pin. See Table 6 for jumper settings.

Table 5. FSEL Description (J4)

| SHUNT POSITION | FSEL PIN | Switching Frequency |
|----------------|-------------------|---------------------|
| Not installed* | Unconnected | 560kHz |
| 1-2 | Connected to SGND | 300kHz |

*Default position.

Table 6. SYNC Description (J7)

| SHUNT POSITION | FSEL PIN | SYNC |
|----------------|-------------------------------|--|
| 1-2 | Connected to test loop on PCB | Frequency can be synchronized with an external clock |
| 2-3* | Connected to SGND | SYNC feature unused |

*Default position.

EV Kit Performance Report

(24V input voltage, unless otherwise noted.)

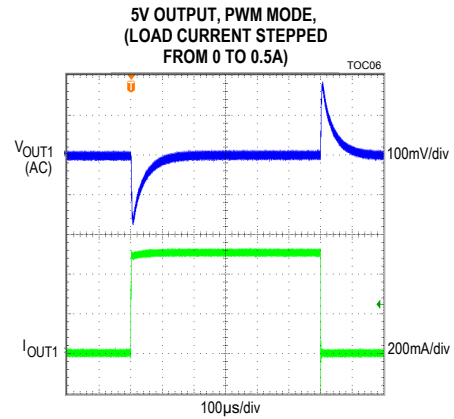
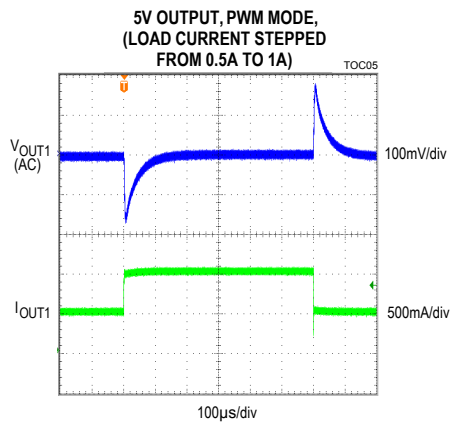
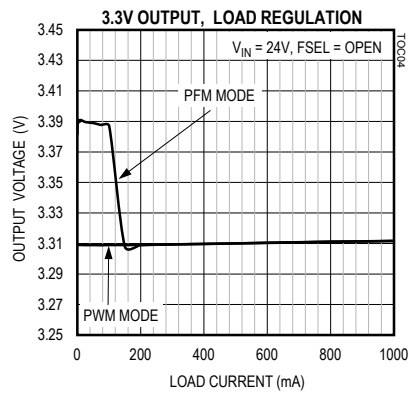
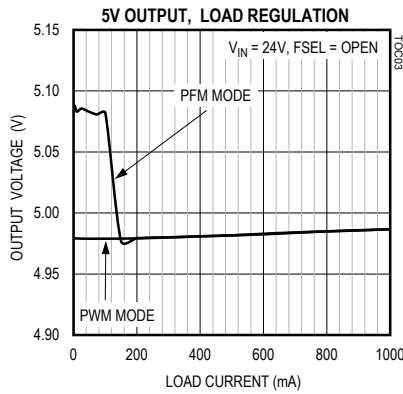
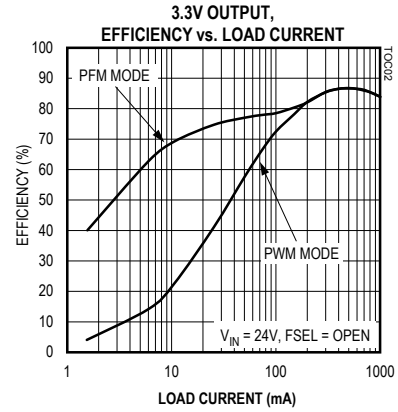
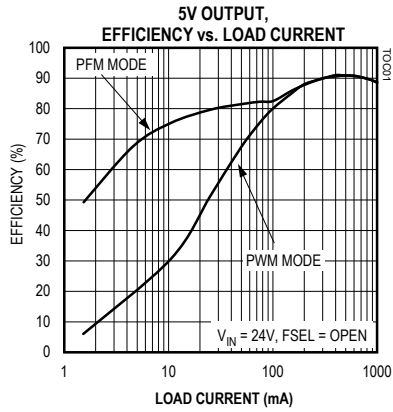

EV Kit Performance Report (continued)

(24V input voltage, unless otherwise noted.)

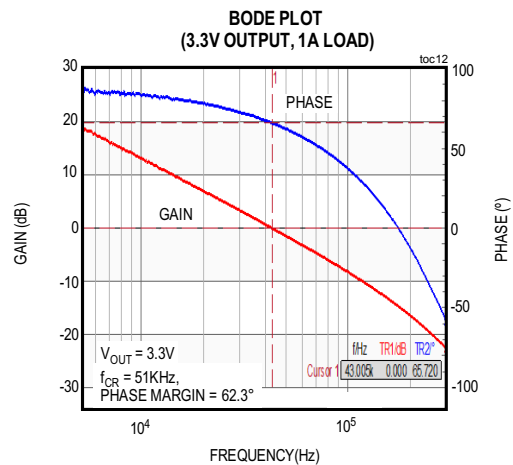
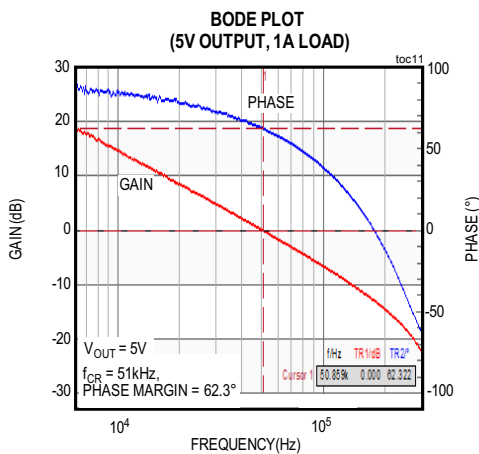
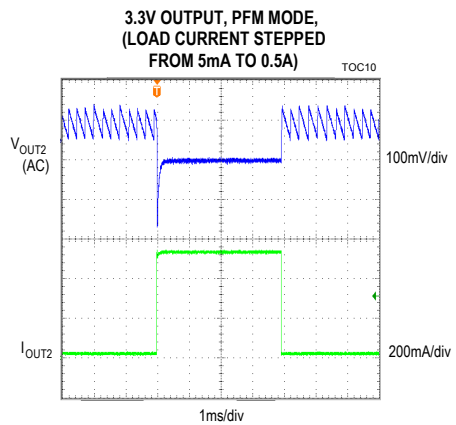
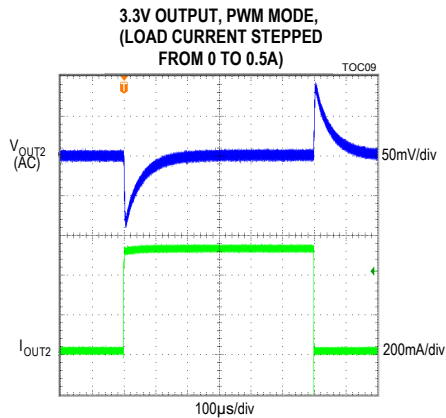
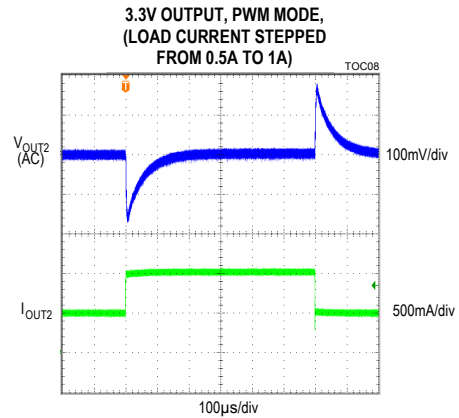
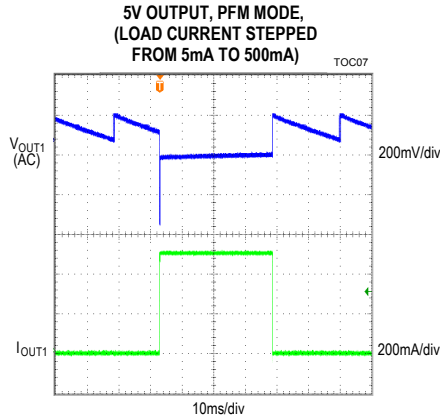

MAX17521 EV Kit Bill of Materials

| Designator | Value | Description | Part Number | Manufacturer | Quantity |
|------------|-------------------------------|-------------------------|--------------------|--------------|----------|
| C1, C2 | 2.2 μ F/X7R/100V/1210 | Input Capacitor | GRM32ER72A225KA35L | Murata | 2 |
| C3 | 10 μ F/X7R/10V/1210 | Output Capacitor | GRM32DR71A106KA01 | Murata | 1 |
| C4 | 22 μ F/X7R/10V/1210 | Output Capacitor | GRM32ER71A226ME20 | Murata | 1 |
| C5, C6 | 1 μ F/X7R/6.3V/0603 | VCC Bypass Capacitor | GRM188R70J105KA01 | Murata | 2 |
| C7, C8 | 3300pF/X7R/50V/0402 | Soft-start Capacitor | GRM155R71H332KA01 | Murata | 2 |
| C9, C11 | 2700pF/X7R/50V/0402 | Compensation Capacitor | GRM155R71H272KA01J | Murata | 2 |
| C10 | 33pF | Compensation Capacitor | GRM1555C1H330JA01D | Murata | 1 |
| C12 | 22pF | Compensation Capacitor | GRM1555C1H220JA01D | Murata | 1 |
| L1 | 22 μ H | Inductor | XAL5050-223 | Coilcraft | 1 |
| L2 | 15 μ H | Inductor | XAL4040-153 | Coilcraft | 1 |
| R1 | 82.5k Ω \pm 1%, 0402 | FB divider Resistor | | Vishay Dale | 1 |
| R2 | 18.2k Ω \pm 1%, 0402 | FB divider Resistor | | Vishay Dale | 1 |
| R3, R11 | 3.3M Ω \pm 1%, 0603 | EN divider Resistor | | Vishay Dale | 2 |
| R4 | 750k Ω \pm 1%, 0603 | EN divider Resistor | | Vishay Dale | 1 |
| R5 | 15.8k Ω \pm 1%, 0402 | Compensation Resistor | | Vishay Dale | 1 |
| R6, R7 | 10k Ω \pm 1%, 0402 | RESET\ pull-up Resistor | | Vishay Dale | 2 |
| R8 | 22.1k Ω \pm 1%, 0402 | Compensation Resistor | | Vishay Dale | 1 |
| R9 | 54.9k Ω \pm 1%, 0402 | FB divider Resistor | | Vishay Dale | 1 |
| R10 | 20.5k Ω \pm 1%, 0402 | FB divider Resistor | | Vishay Dale | 1 |
| R12 | 1M Ω \pm 1%, 0603 | EN divider Resistor | | Vishay Dale | 1 |
| U1 | MAX17521 | DC-DC Converter | MAX17521ATG+ | Maxim | 1 |

Component Suppliers

| SUPPLIER | WEBSITE |
|-----------------|-------------------|
| Coilcraft, Inc. | www.coilcraft.com |
| Murata Americas | www.murata.com |
| Vishay | www.vishay.com |

Note: Indicate that you are using the MAX17521 when contacting these component suppliers.

Ordering Information

| PART | TYPE |
|-----------------|--------|
| MAX17521EVKITA# | EV kit |

#Denotes RoHS-compliant.

MAX17521 EV Kit Schematic

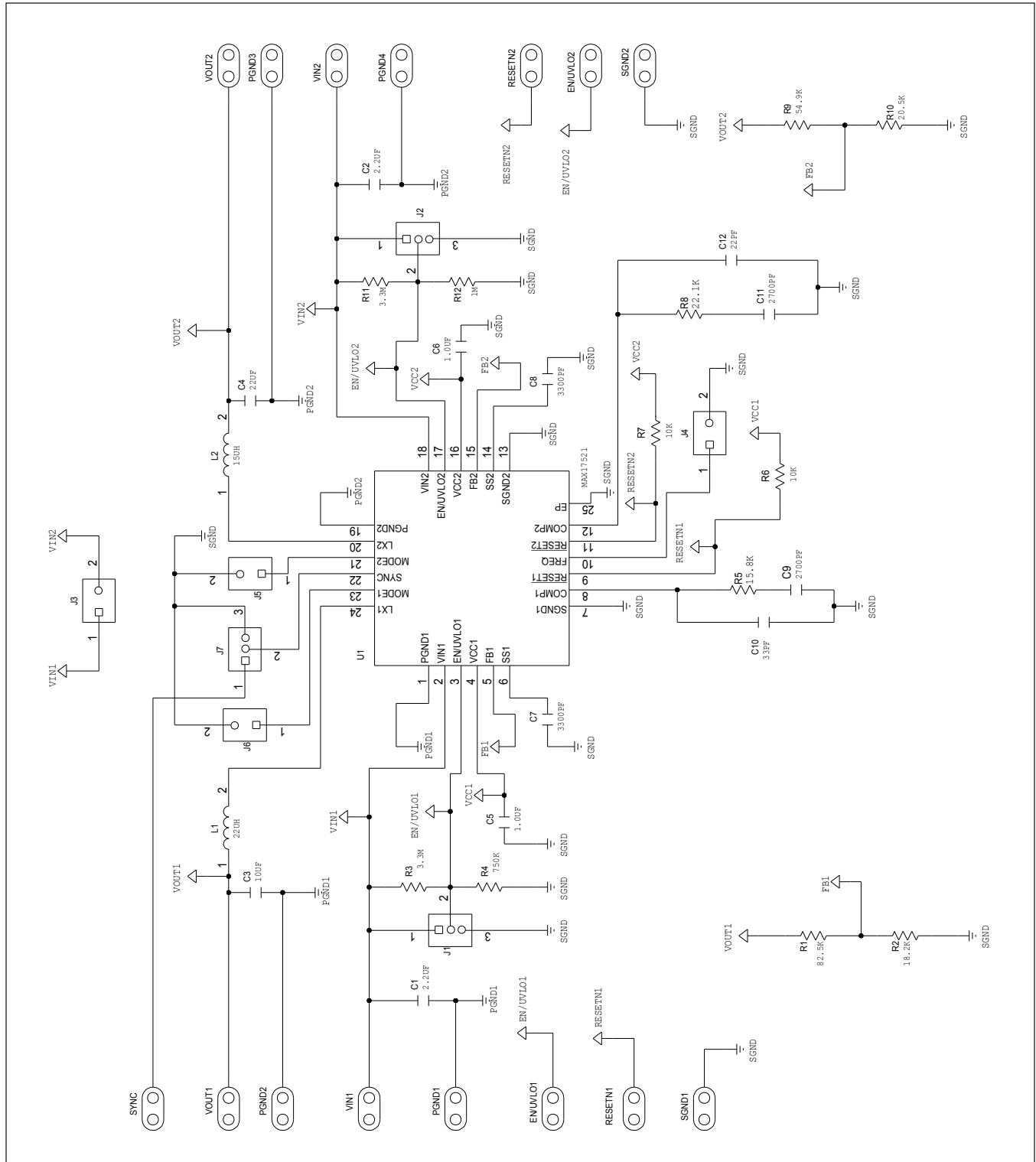

MAX17521 Evaluation Kit

Evaluates: MAX17521 in 3.3V and 5V Output-Voltage Application

MAX17521 EV Kit PCB Layout

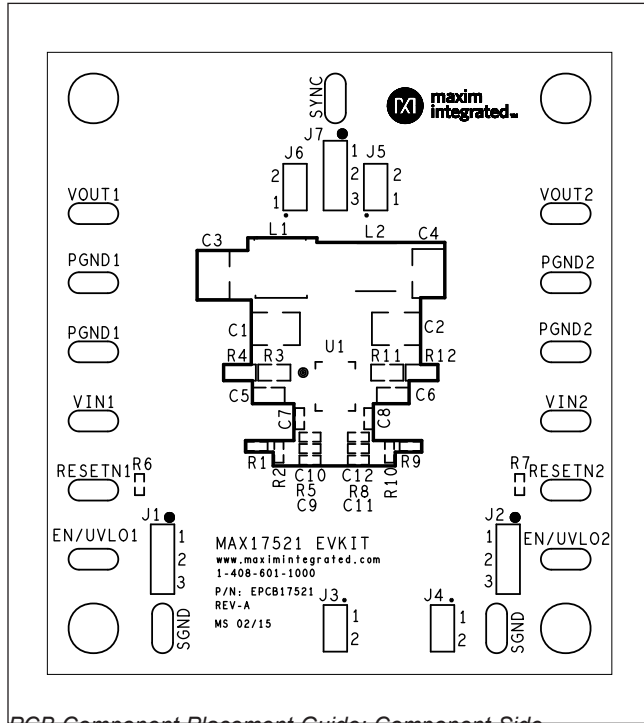

PCB Component Placement Guide: Component Side

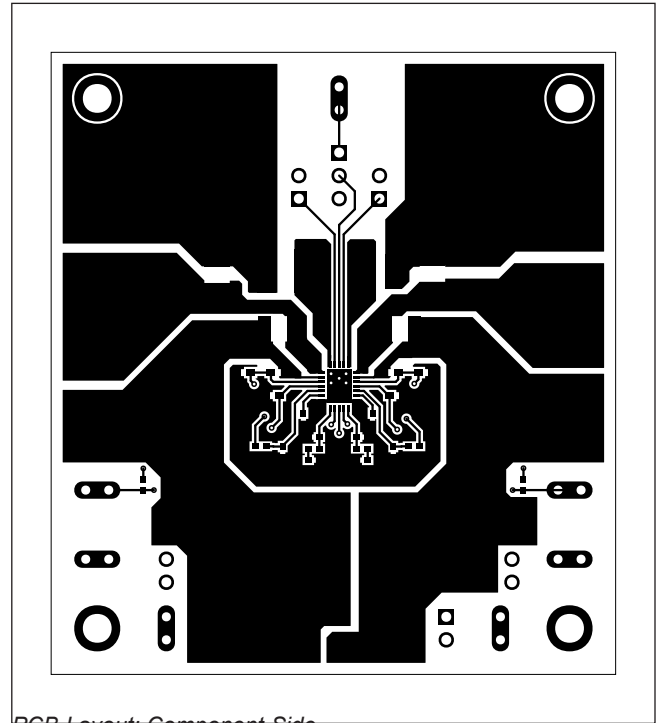

PCB Layout: Component Side

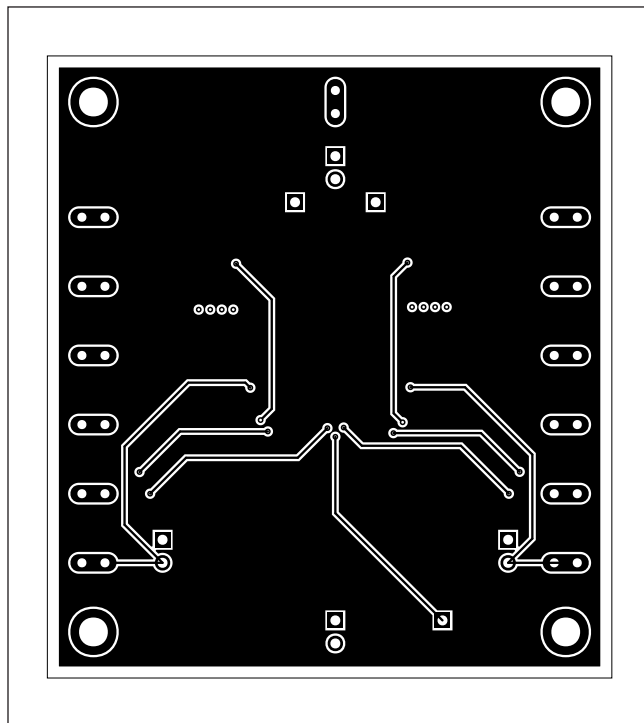

PCB Layout: Inner Layer 1

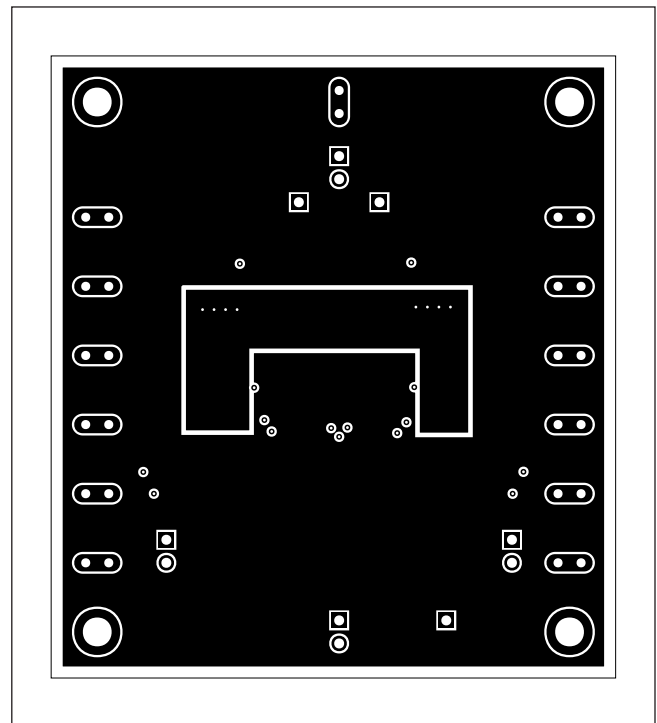

PCB Layout: Inner Layer 2

MAX17521 EV Kit PCB Layout (continued)

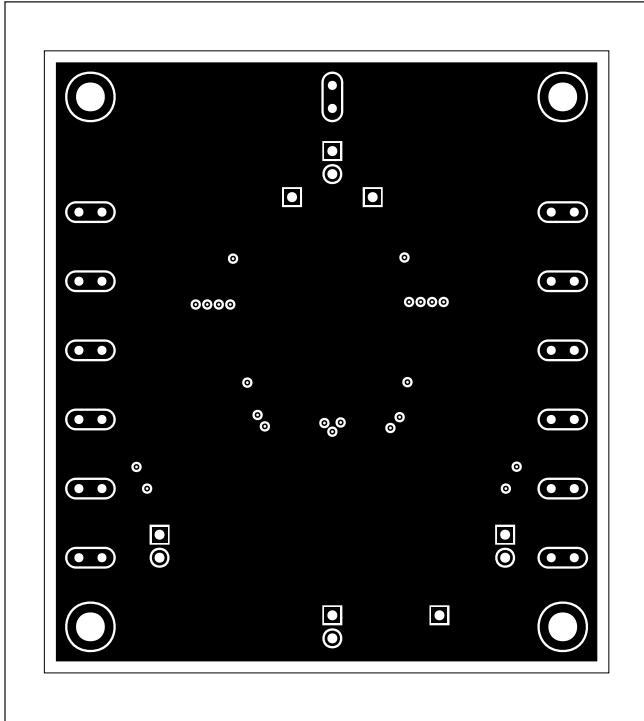

PCB Layout: Solder Side

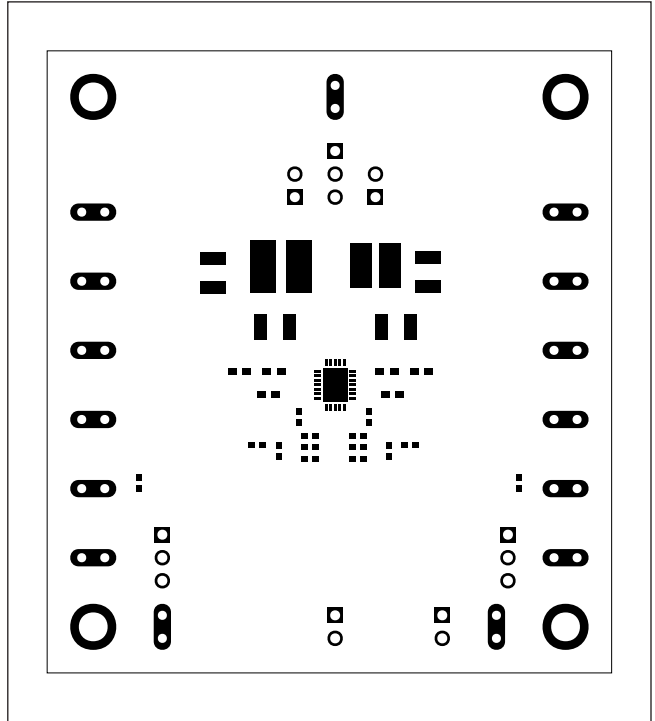

PCB Layout: Solder Mask

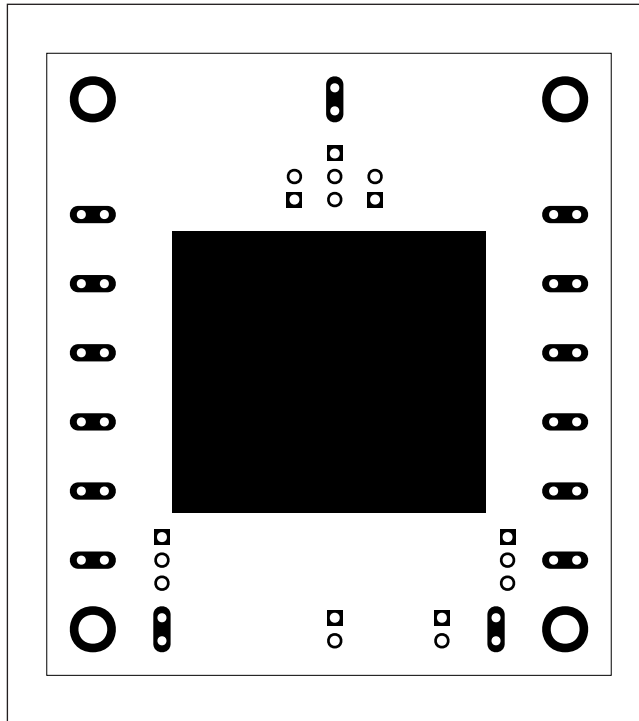

PCB Layout: Component Placement Guide: Bottom Solder Mask

Revision History

| REVISION NUMBER | REVISION DATE | DESCRIPTION | PAGES CHANGED |
|-----------------|---------------|---|---------------|
| 0 | 6/15 | Initial release | — |
| 1 | 7/17 | Corrected symbols in equations in the <i>Soft-Start Input (SS)</i> and <i>Regulator Enable/Undervoltage-Lockout Level (EN/UVLO1, EN/UVLO2)</i> sections. Updated part number in <i>Ordering Information</i> table to MAX17521EVKITA#. | 2, 6 |

For pricing, delivery, and ordering information, please contact Maxim Direct at 1-888-629-4642, or visit Maxim Integrated's website at www.maximintegrated.com.

Maxim Integrated cannot assume responsibility for use of any circuitry other than circuitry entirely embodied in a Maxim Integrated product. No circuit patent licenses are implied. Maxim Integrated reserves the right to change the circuitry and specifications without notice at any time.

X-ON Electronics

Largest Supplier of Electrical and Electronic Components

Click to view similar products for [Power Management IC Development Tools](#) category:

Click to view products by [Maxim](#) manufacturer:

Other Similar products are found below :

[EVB-EP5348UI](#) [MIC23451-AAAYFL EV](#) [MIC5281YMME EV](#) [124352-HMC860LP3E](#) [DA9063-EVAL](#) [ADP122-3.3-EVALZ](#) [ADP130-0.8-EVALZ](#) [ADP130-1.8-EVALZ](#) [ADP1740-1.5-EVALZ](#) [ADP1870-0.3-EVALZ](#) [ADP1874-0.3-EVALZ](#) [ADP199CB-EVALZ](#) [ADP2102-1.25-EVALZ](#) [ADP2102-1.875EVALZ](#) [ADP2102-1.8-EVALZ](#) [ADP2102-2-EVALZ](#) [ADP2102-3-EVALZ](#) [ADP2102-4-EVALZ](#) [AS3606-DB](#) [BQ25010EVM](#) [BQ3055EVM](#) [ISLUSBI2CKIT1Z](#) [LP38512TS-1.8EV](#) [EVAL-ADM1186-1MBZ](#) [EVAL-ADM1186-2MBZ](#) [ADP122UJZ-REDYKIT](#) [ADP166Z-REDYKIT](#) [ADP170-1.8-EVALZ](#) [ADP171-EVALZ](#) [ADP1853-EVALZ](#) [ADP1873-0.3-EVALZ](#) [ADP198CP-EVALZ](#) [ADP2102-1.0-EVALZ](#) [ADP2102-1-EVALZ](#) [ADP2107-1.8-EVALZ](#) [ADP5020CP-EVALZ](#) [CC-ACC-DBMX-51](#) [ATPL230A-EK](#) [MIC23250-S4YMT EV](#) [MIC26603YJL EV](#) [MIC33050-SYHL EV](#) [TPS60100EVM-131](#) [TPS65010EVM-230](#) [TPS71933-28EVM-213](#) [TPS72728YFFEVM-407](#) [TPS79318YEQEVM](#) [UCC28810EVM-002](#) [XILINXPWR-083](#) [LMR22007YMINI-EVM](#) [LP38501ATJ-EV](#)