

MAX17524 Dual Output Evaluation Kit

Evaluates: MAX17524 Dual-Output Voltage 3.3V and 5V Application

General Description

The MAX17524 evaluation kit (EV kit) provides a proven design to evaluate the MAX17524 high-efficiency, high-voltage, synchronous step-down dual DC-DC converter. The EV kit is preset to generate 3.3V and 5V output voltages, at load currents up to 3A per converter and features a 450kHz switching frequency for optimum efficiency and component size. The EV kit features adjustable input undervoltage lockout, adjustable soft-start, open-drain $\overline{\text{RESET}}$ signal, and external frequency synchronization.

Features

- Operates from a 6.5V to 60V Input Supply
- Dual Output Voltage: 3.3V and 5V
- Up to 3A Output Current Per Converter
- 450kHz Switching Frequency
- Enable/UVLO Input, Resistor-Programmable UVLO Threshold
- MODE/SYNC Pin to Select Among PWM, PFM, or DCM Modes
- Open-Drain $\overline{\text{RESET}}$ Output
- External Frequency Synchronization
- Overcurrent and Overtemperature Protection
- Proven PCB Layout
- Fully Assembled and Tested

Ordering Information appears at end of data sheet.

Quick Start

Recommended Equipment

- MAX17524EVKIT#
- 6.5V to 60V, 5A DC-input power supply
- Two loads capable of sinking 3A
- Two digital voltmeters (DVM)

Equipment Setup and Test Procedure

The EV kit is fully assembled and tested. Follow the steps below to verify the board operation. **Caution: Do not turn on power supply until all connections are completed.**

- 1) Set the power supply at a voltage between 6.5V and 60V. Disable the power supply.
- 2) Connect the positive terminal of the power supply to the VIN1 PCB pad and the negative terminal to the nearest PGND1 PCB pad. Connect the positive terminal of the 3A load to the VOUT1 PCB pad and the negative terminal to the nearest PGND1 PCB pad. Connect the positive terminal of the other 3A load to the VOUT2 PCB pad and the negative terminal to the nearest PGND2 PCB pad.
- 3) Connect the DVMs across the VOUT1 PCB pad and the nearest PGND1 PCB pad, and across the VOUT2 PCB pad and the nearest PGND2 PCB pad.
- 4) Verify that shunts are installed across pins 1-2 on jumper JU4 and pins 1-2 on JU5 (see [Table 1](#) and [2](#)).
- 5) Select the shunt position on jumper JU1 and JU2 according to the intended mode of operation (see [Table 3](#) and [4](#)).
- 6) Verify that the shunt is connected across pins 1-2 on jumper JU3 (see [Table 5](#) for details).
- 7) Turn on the DC power supply.
- 8) Enable the loads.
- 9) Verify that the DVMs display 3.3V and 5V.

MAX17524 Dual Output Evaluation Kit

Evaluates: MAX17524 Dual-Output Voltage 3.3V and 5V Application

Detailed Description

The MAX17524 EV kit provides a proven design to evaluate the MAX17524 high-efficiency, high-voltage, synchronous step-down Dual DC-DC converter. The EV kit generates a fixed 3.3V and 5V, at load currents up to 3A per channel, from a 6.5V to 60V input supply. The EV kit features a 450kHz fixed switching frequency for optimum efficiency and component size.

This EV kit includes an EN/UVLO PCB pad and JU4, JU5 to enable the two outputs at a desired input voltage. The MODE/SYNC1 PCB pad and JU1, and MODE/SYNC2 PCB pad and JU2 allow an external clock to synchronize the respective channels. The EV kit features individual mode-of-operation selector pins, adjustable input under-voltage lockout (EN/UVLO) pins, adjustable soft-start pins, open-drain RESET signals for each output channel.

Soft-Start Input (SS)

The device implements adjustable soft-start operation for each output to reduce inrush current. Capacitors connected from the SS pins to SGND (C_{SS}) programs the soft-start time for the corresponding output voltage. The selected output capacitance (C_{SEL}) and the output voltage (V_{OUT}) determine the minimum required soft-start capacitor as follows:

$$C_{SS} \geq 28 \times 10^{-6} \times C_{SEL} \times V_{OUT}$$

The soft-start time (t_{SS}) is related to the capacitor connected at SS (C_{SS}) by the following Equation:

$$t_{SS} = \frac{C_{SS}}{(5.55 \times 10^{-6})}$$

For example, to program a 1ms soft-start time on one channel, a 5.6nF capacitor should be connected from the corresponding SS pin to SGND.

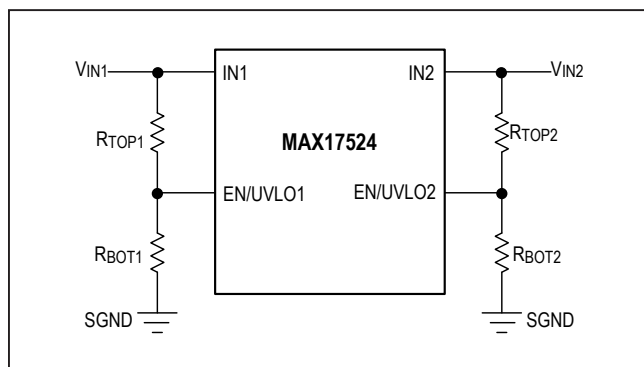

Figure 1. Setting the Input Undervoltage Lockout

Setting the Input Enable/Undervoltage-Lockout Level (EN/UVLO1, EN/UVLO2)

The device offers an adjustable input undervoltage-lockout level for each output. Set the voltage at which each converter turns on with a resistive voltage-divider connected from $V_{IN_}$ to SGND. Connect the center node of the divider to EN/UVLO pins as shown in Figure 1.

Choose $R_{TOP_}$ to be 3.3M Ω , and then calculate $R_{BOT_}$ as:

$$R_{BOT_} = \frac{R_{TOP_} \times 1.216}{V_{INU_} - 1.216}$$

Where $V_{INU_}$ is the input voltage at which the desired converter is required to turn on. Install a shunt across pins 1-2 on JU4 and JU5 to enable the EV kit outputs and for always on operation. See Table 1 and Table 2 for proper jumper settings.

Table 1. Regulator Enable (EN/UVLO1) Description (JU4)

SHUNT POSITION	EN/UVLO1 PIN	MAX17524_OUTPUT1
1-2*	Connected to V_{IN1}	Enabled
Not installed	Connected to the center node of resistor-divider R1 and R2	Enabled, UVLO level set through the R1 and R2 resistors
2-3	Connected to SGND	Disabled

Table 2. Regulator Enable (EN/UVLO2) Description (JU5)

SHUNT POSITION	EN/UVLO2 PIN	MAX17524_OUTPUT2
1-2*	Connected to V_{IN2}	Enabled
Not installed	Connected to the center node of resistor-divider R3 and R4	Enabled, UVLO level set through the R3 and R4 resistors
2-3	Connected to SGND	Disabled

MAX17524 Dual Output Evaluation Kit

Evaluates: MAX17524 Dual-Output Voltage 3.3V and 5V Application

MODE Selection and External Synchronization (MODE/SYNC1, MODE/SYNC2)

The device's MODE/SYNC pins can be used to select among PWM, PFM, or DCM modes of operation for each output. The logic state of the MODE pin is latched when VCC and EN/UVLO voltages exceed the respective UVLO rising thresholds and all internal voltages are ready to allow LX switching. State changes on the MODE pin are ignored during normal operation. Refer to the MAX17524 IC data sheet for more information on PWM, PFM, and DCM modes of operation.

Table 3. MODE/SYNC1 Description (JU1)

SHUNT POSITION	MODE/ SYNC1 PIN	MAX17524_ MODE1
Not installed	Unconnected	PFM mode of operation
1-2*	Connected to SGND	PWM mode of operation
2-3	Connected to V _{CC}	DCM mode of operation

*Default position

Table 3 and Table 4 show EV kit jumper settings that can be used to configure the desired mode of operation.

The internal clock of each converter can be synchronized to an external clock signal on the MODE/SYNC1 and MODE/SYNC2 pins. The external synchronization clock frequency must be between $1.1 \times f_{SW}$ and $1.4 \times f_{SW}$, where f_{SW} is the frequency of operation set by resistor (R11) connected to the RT pin. The minimum external clock high pulse width should be greater than 50ns and the minimum external clock low pulse width should be greater than 160ns.

Table 4. MODE/SYNC2 Description (JU2)

SHUNT POSITION	MODE/ SYNC2 PIN	MAX17524_ MODE2
Not installed	Unconnected	PFM mode of operation
1-2*	Connected to SGND	PWM mode of operation
2-3	Connected to V _{CC}	DCM mode of operation

*Default position

Table 5. V_{IN2} Connection (JU3)

SHUNT POSITION	V _{IN2} PIN	MAX17524_ OUTPUT
Not installed	Not powered up from V _{IN1}	No output at V _{OUT2}
1-2*	Powered up from V _{IN1}	3.3V Output at V _{OUT2}

*Default position

MAX17524 Dual Output Evaluation Kit

Evaluates: MAX17524 Dual-Output Voltage 3.3V and 5V Application

MAX17524 EV Kit Performance Report

($V_{IN1} = V_{IN2} = 24V$, $T_A = +25^\circ C$, unless otherwise noted.)

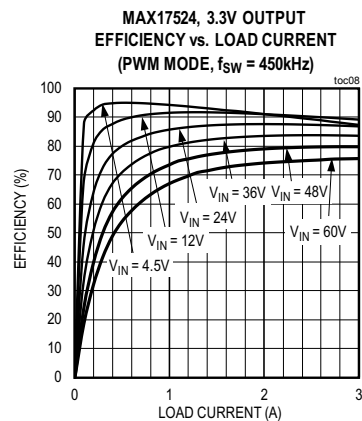
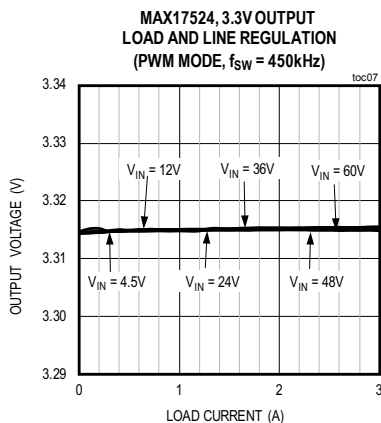
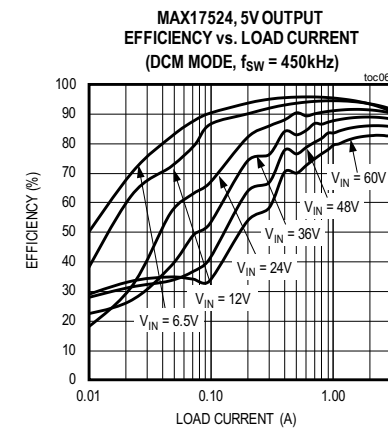
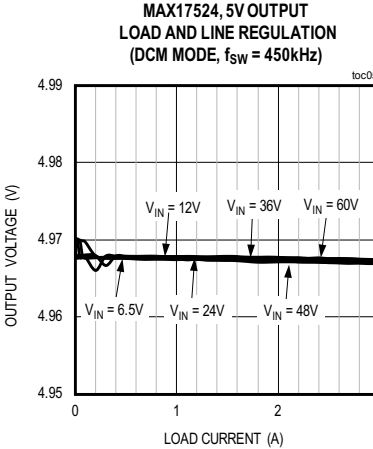
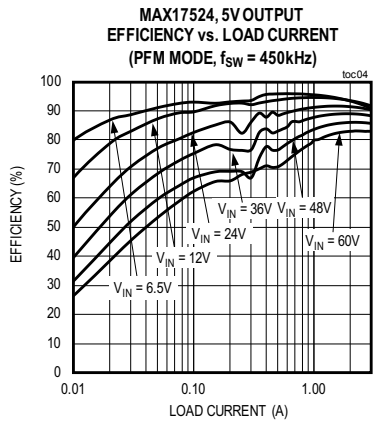
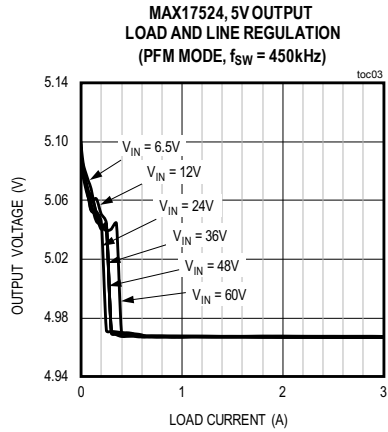
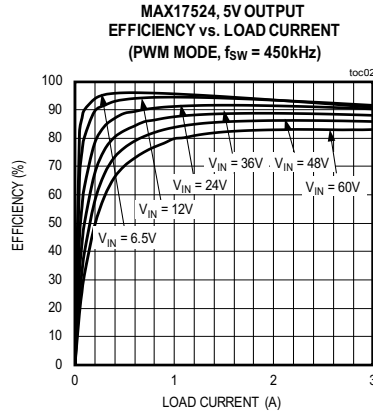
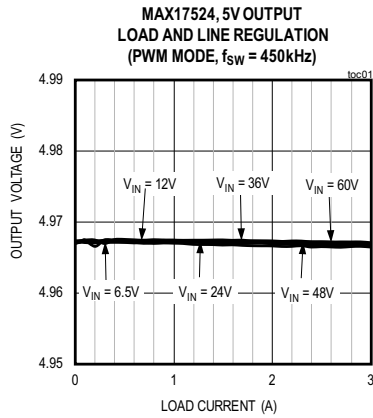

MAX17524 EV Kit Performance Report (continued)

($V_{IN1} = V_{IN2} = 24V$, $T_A = +25^\circ C$, unless otherwise noted.)

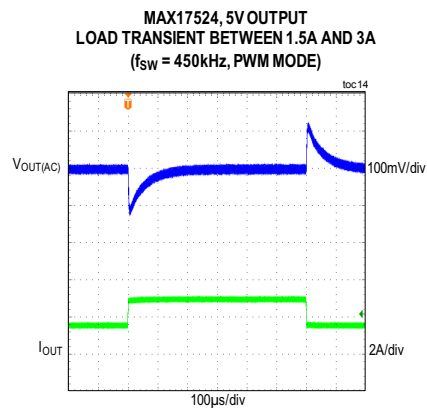
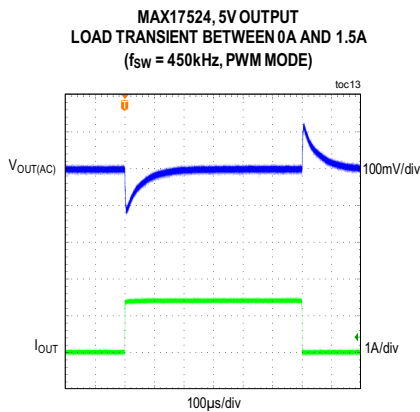
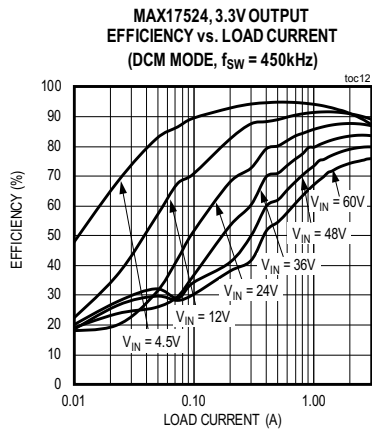
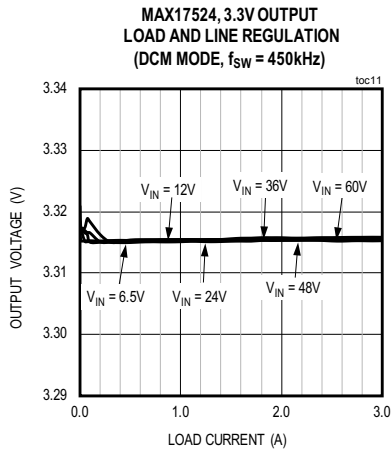
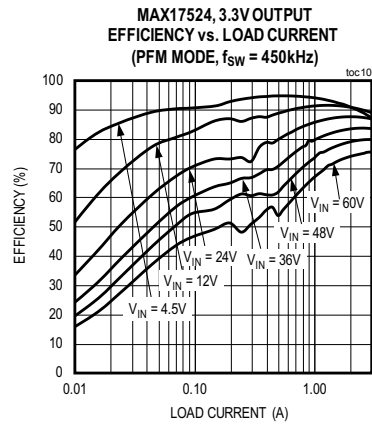
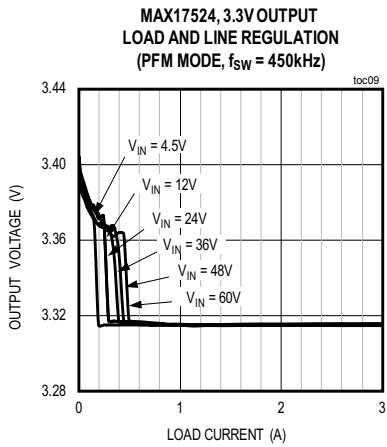

MAX17524 EV Kit Performance Report (continued)

($V_{IN1} = V_{IN2} = 24V$, $T_A = +25^\circ C$, unless otherwise noted.)

MAX17524, 5V OUTPUT
LOAD TRANSIENT BETWEEN 50mA AND 1.5A
($f_{sw} = 450kHz$, PFM MODE)

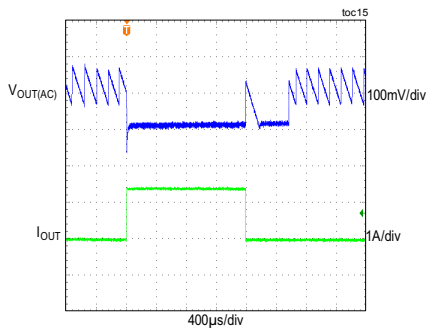

MAX17524, 5V OUTPUT
LOAD TRANSIENT BETWEEN 50mA AND 1.5A
($f_{sw} = 450kHz$, DCM MODE)

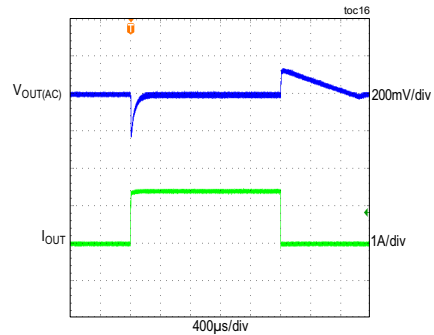

MAX17524, 3.3V OUTPUT
LOAD TRANSIENT BETWEEN 0A AND 1.5A
($f_{sw} = 450kHz$, PWM MODE)

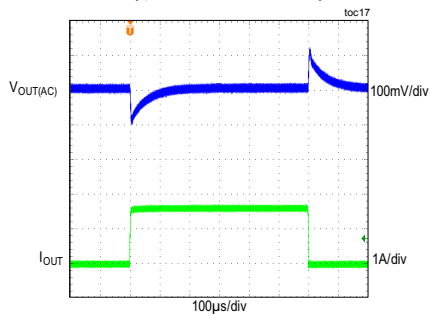

MAX17524, 3.3V OUTPUT
LOAD TRANSIENT BETWEEN 1.5A AND 3A
($f_{sw} = 450kHz$, PWM MODE)

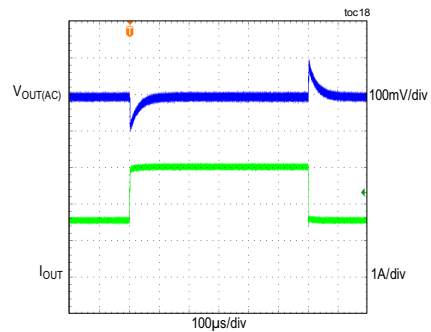

MAX17524, 3.3V OUTPUT
LOAD TRANSIENT BETWEEN 50mA AND 1.5A
($f_{sw} = 450kHz$, PFM MODE)

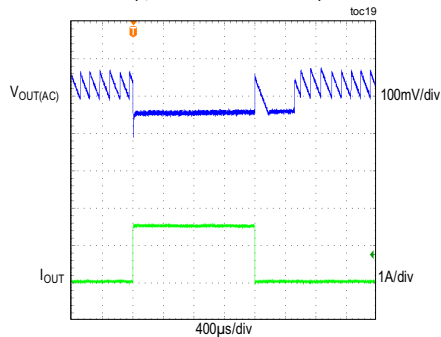

MAX17524, 3.3V OUTPUT
LOAD TRANSIENT BETWEEN 50mA AND 1.5A
($f_{sw} = 450kHz$, DCM MODE)

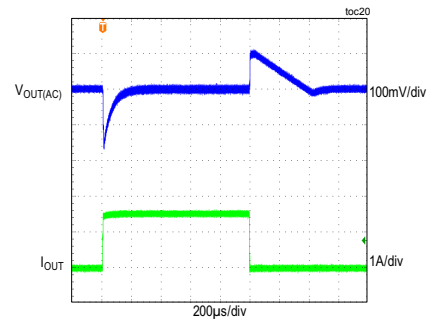

MAX17524 EV Kit Performance Report (continued)

($V_{IN1} = V_{IN2} = 24V$, $T_A = +25^\circ C$, unless otherwise noted.)

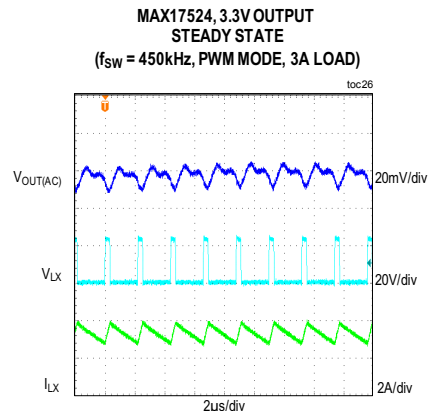
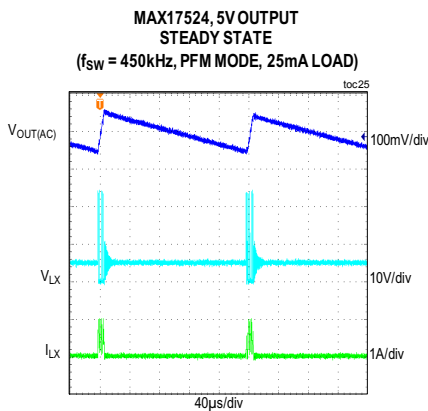
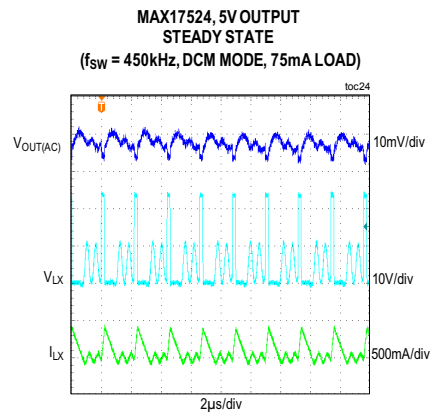
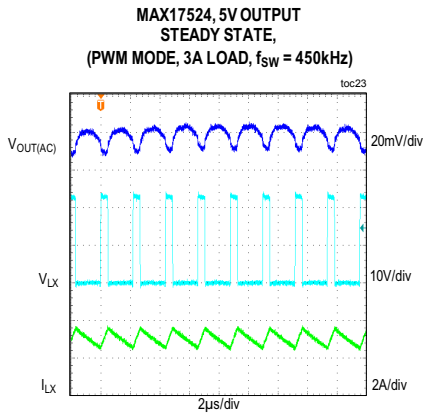
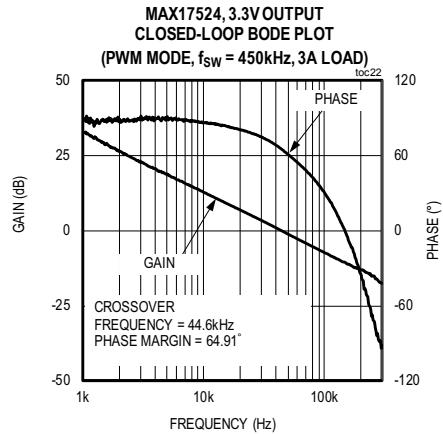
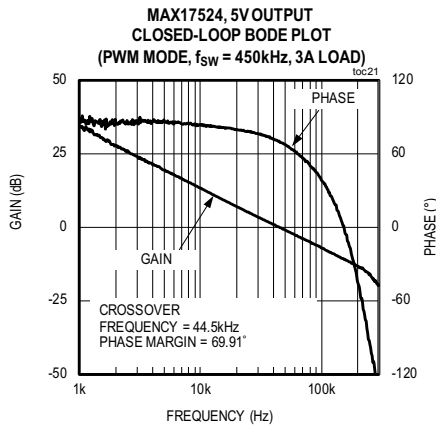

MAX17524 Dual Output Evaluation Kit

Evaluates: MAX17524 Dual-Output Voltage 3.3V and 5V Application

MAX17524 EV Kit Performance Report (continued)

($V_{IN1} = V_{IN2} = 24V$, $T_A = +25^\circ C$, unless otherwise noted.)

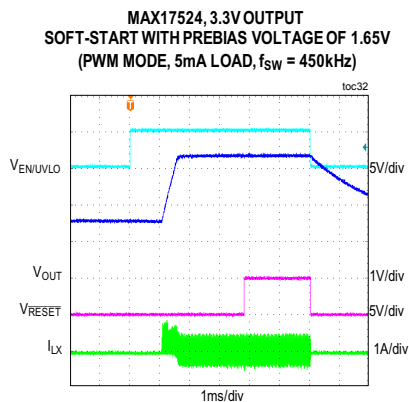
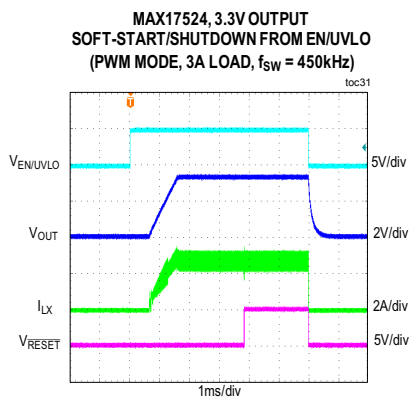
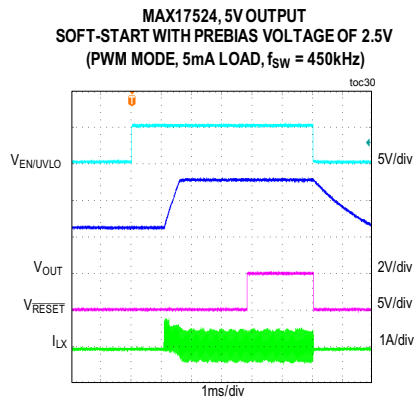
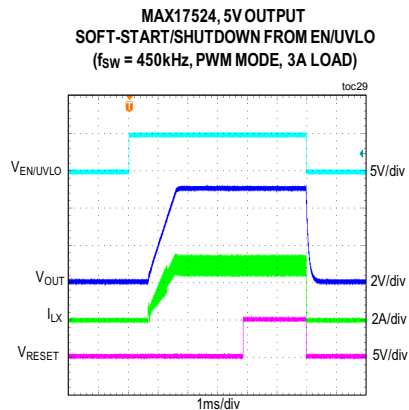
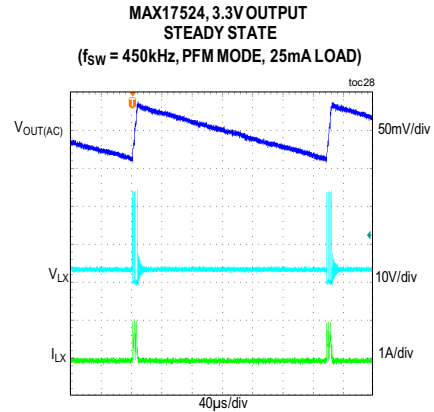
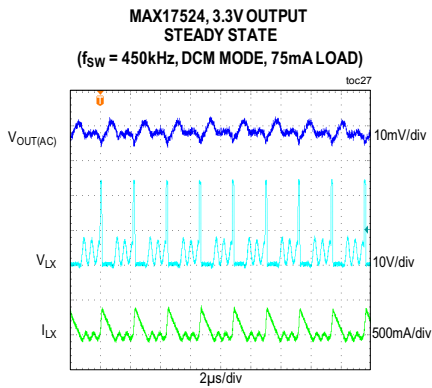

MAX17524 Dual Output Evaluation Kit

Evaluates: MAX17524 Dual-Output
Voltage 3.3V and 5V Application

Ordering Information

PART	TYPE
MAX17524EVKIT#	EV Kit

#Denotes RoHS compliant.

Component Suppliers

SUPPLIER	WEBSITE
Coilcraft, Inc.	www.coilcraft.com
Murata Americas	www.murataamericas.com
Panasonic Corp.	www.panasonic.com
Vishay	www.vishay.com

Note: Indicate that you are using the MAX17524 when contacting these component suppliers.

MAX17524 EV Kit Bill of Materials

No.	Description	Quantity	Designator	Part Number
1	47uF, 20%, 80V, Electrolytic capacitor	1	C1	PANASONIC EEE-FK1K470P
2	2.2uF, 10%, 100V, X7R, Ceramic capacitor (1210)	2	C2, C5	MURATA GRM32ER72A225KA35
3	0.1uF, 10%, 100V, X7R, Ceramic capacitor (0603)	2	C3, C4	MURATA GRM188R72A104KA35
4	22uF, 10%, 10V, X7R, Ceramic capacitor (1210)	2	C6, C18	MURATA GRM32ER71A226K
5	47uF, 10%, 10V, X7R, Ceramic capacitor (1210)	2	C7, C19	MURATA GRM32ER71A476KE15
6	2.2uF, 10%, 10V, X7R, Ceramic capacitor (0603)	2	C8, C9	MURATA GRM188R71A225KE15
7	5600pF, 10%, 25V, X7R, Ceramic capacitor (0402)	2	C10, C11	MURATA GRM155R71E562KA01
8	0.1uF, 10%, 16V, X7R, Ceramic capacitor (0402)	2	C12, C13	MURATA GRM155R71C104KA88
9	0.1uF, 10%, 50V, X7R, Ceramic capacitor (0402)	2	C16, C17	MURATA GRM155R71H104KE14
10	3-pin header (36-pin header 0.1" centers)	4	JU1, JU2, JU4, JU5	SULLINS PEC03SAAN
11	2-pin header (36-pin header 0.1" centers)	1	JU3	SULLINS PEC02SAAN
12	INDUCTOR, 10uH, 7A	1	L1	COILCRAFT XAL6060-103ME
13	INDUCTOR, 6.8uH, 9A	1	L2	COILCRAFT XAL6060-682ME
14	MOSFET (80V, 30A)	2	Q1, Q2	VISHAY SILICONIX SIS468DN-T1-GE3
15	3.32MΩ, ±1%, 1/10W, resistor (0603)	2	R1, R3	Any
16	768kΩ, ±1%, 1/10W, resistor (0603)	2	R2, R4	Any
17	140kΩ, ±1%, 1/10W, resistor (0402)	1	R5	Any
18	30.9kΩ, ±1%, 1/16W, resistor (0402)	1	R6	Any
19	100kΩ, ±1%, 1/16W, resistor (0402)	1	R7	Any
20	37.4kΩ, ±1%, 1/16W, resistor (0402)	1	R8	Any
21	10kΩ, ±1%, 1/16W, resistor (0402)	4	R9, R10, R16, R17	Any
22	0Ω, ±5%, 1/16W, resistor (0402)	2	R12, R13	Any
23	4.7Ω, ±1%, 1/16W, resistor (0402)	2	R14, R15	Any
24	Dual Buck Converter, MAX17524	1	U1	MAXIM MAX17524ATJ+

Jumper Table	
Jumper	Shunt Position
JU1, JU2, JU3, JU4, JU5	1-2 Short

MAX17524 Dual Output Evaluation Kit

Evaluates: MAX17524 Dual-Output Voltage 3.3V and 5V Application

MAX17524 EV Kit Schematic

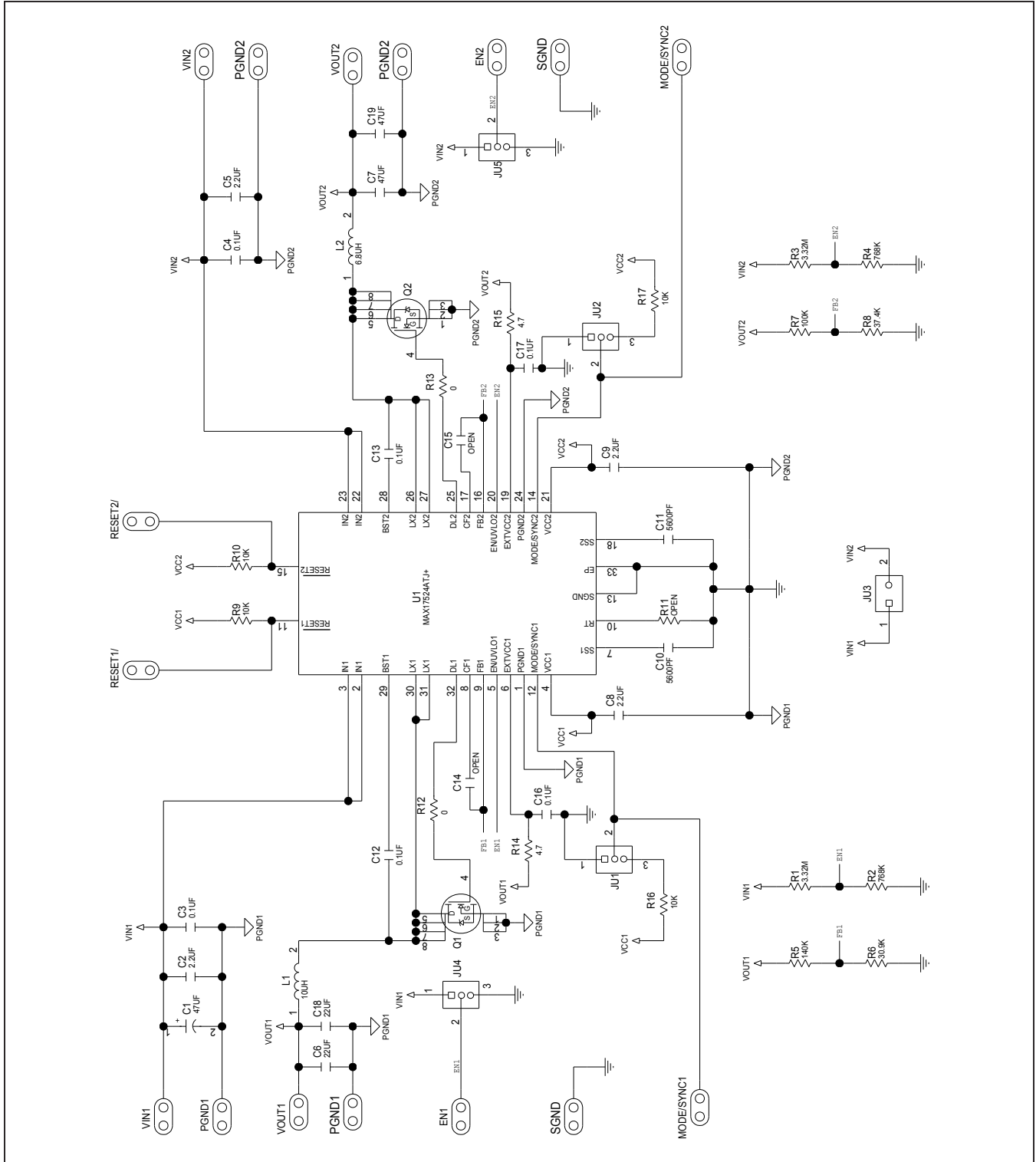

MAX17524 Dual Output Evaluation Kit

Evaluates: MAX17524 Dual-Output Voltage 3.3V and 5V Application

MAX17524 EV Kit PCB Layout

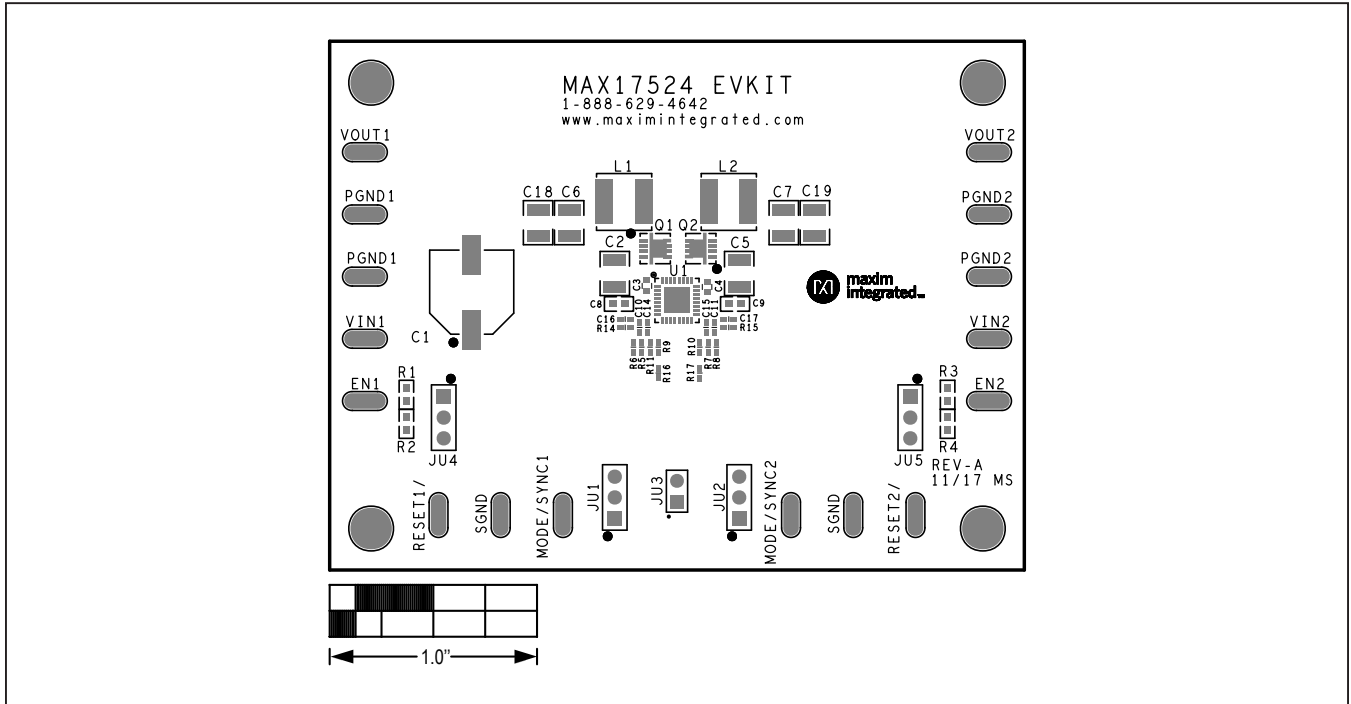

MAX17524 EV Kit PCB—Top Silkscreen

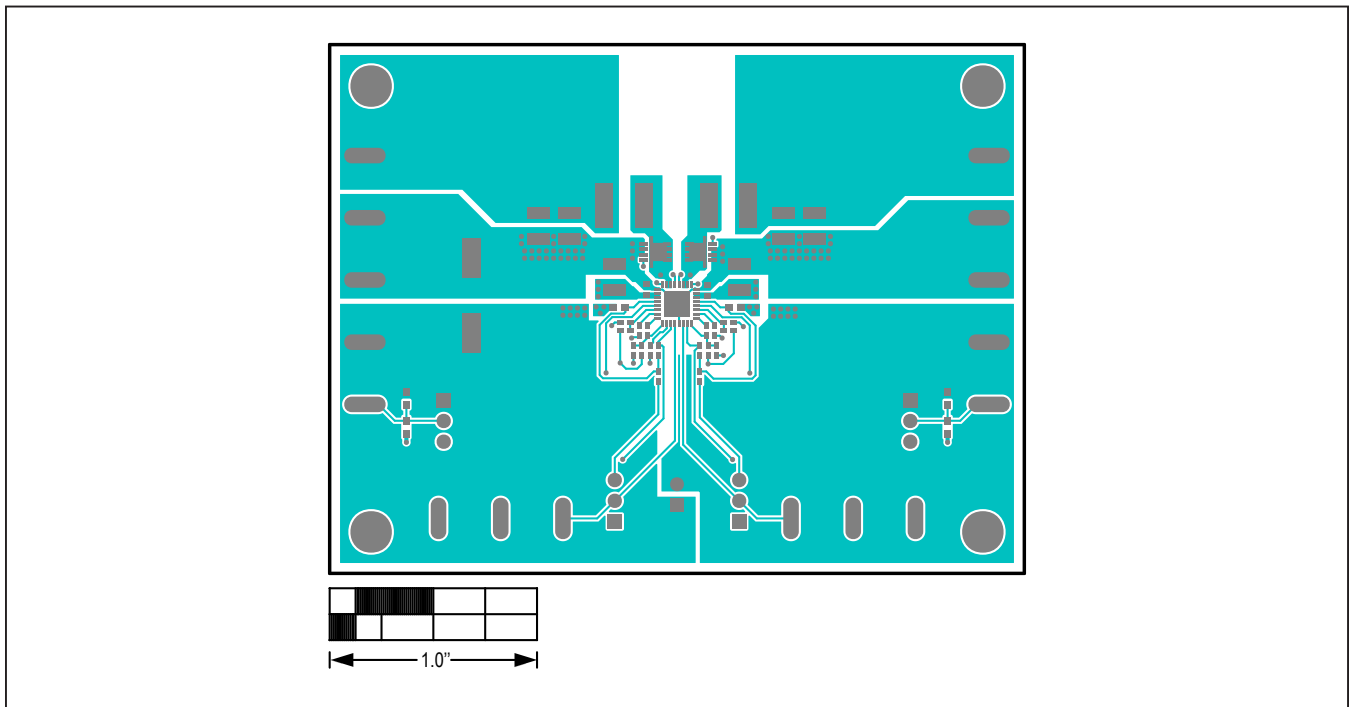

MAX17524 EV Kit PCB—Top Layer

MAX17524 EV Kit PCB Layout (continued)

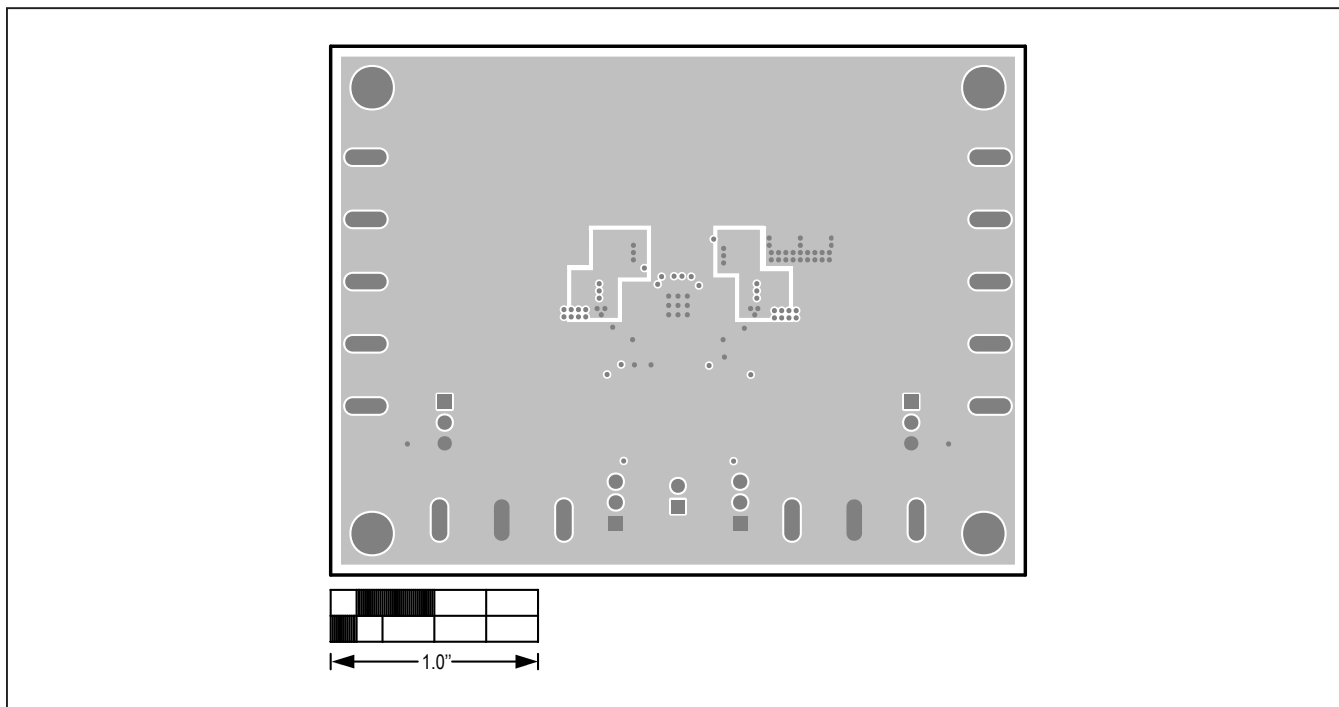

MAX17524 EV Kit PCB—Layer 2

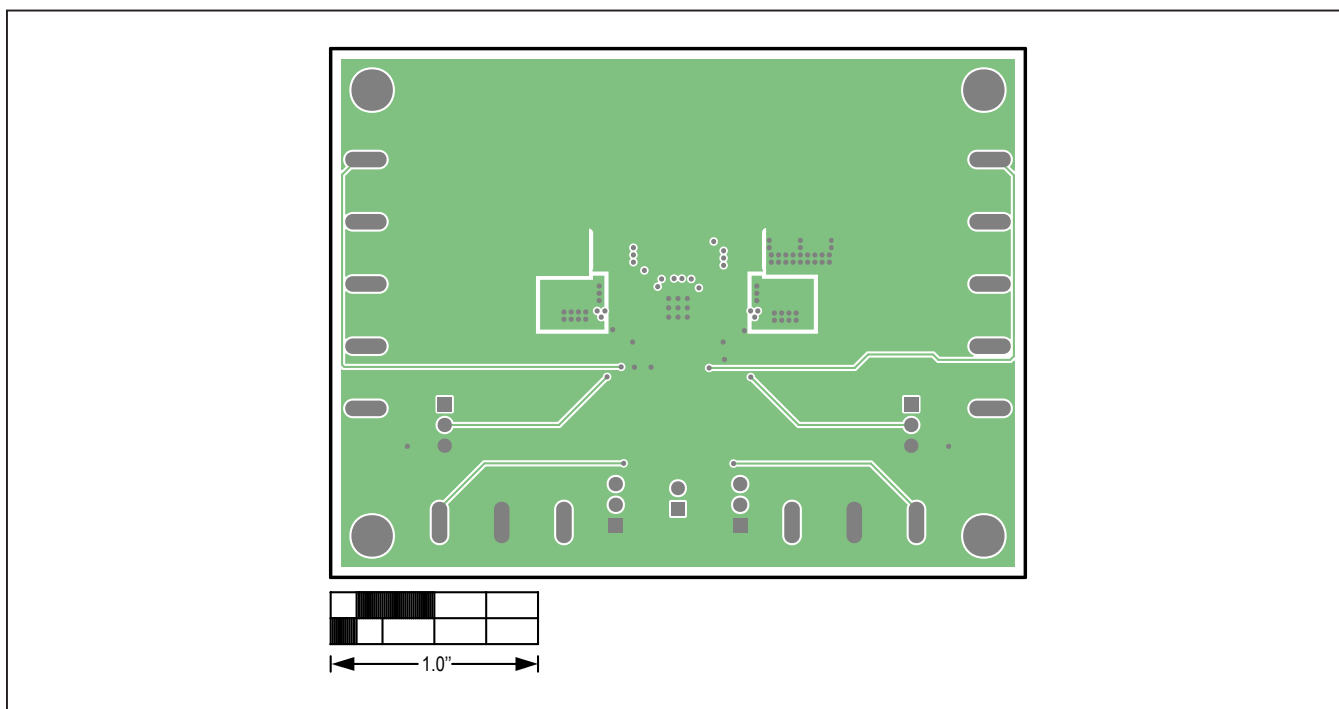

MAX17524 EV Kit PCB—Layer 3

MAX17524 EV Kit PCB Layout (continued)

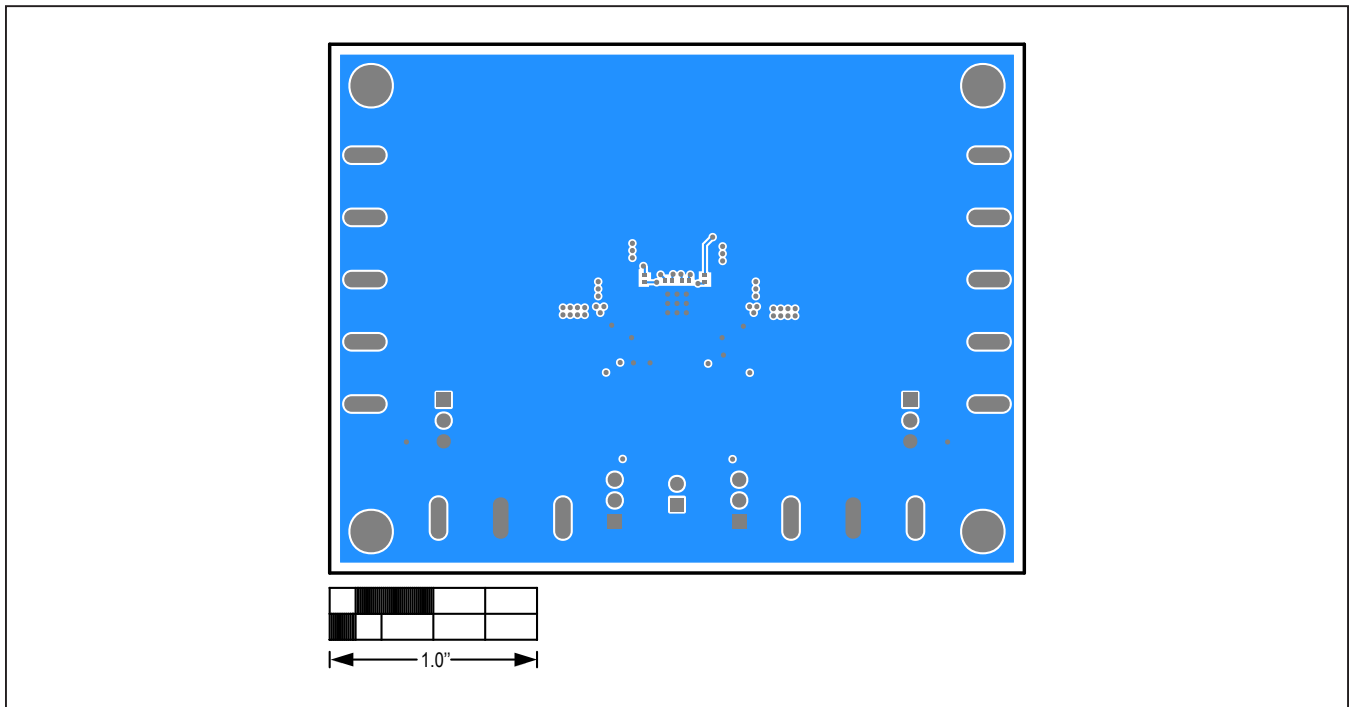

MAX17524 EV Kit PCB—Bottom Layer

MAX17524 Dual Output
Evaluation Kit

Evaluates: MAX17524 Dual-Output
Voltage 3.3V and 5V Application

Revision History

REVISION NUMBER	REVISION DATE	DESCRIPTION	PAGES CHANGED
0	12/17	Initial release	—

For pricing, delivery, and ordering information, please contact Maxim Direct at 1-888-629-4642, or visit Maxim Integrated's website at www.maximintegrated.com.

Maxim Integrated cannot assume responsibility for use of any circuitry other than circuitry entirely embodied in a Maxim Integrated product. No circuit patent licenses are implied. Maxim Integrated reserves the right to change the circuitry and specifications without notice at any time.

X-ON Electronics

Largest Supplier of Electrical and Electronic Components

Click to view similar products for [Power Management IC Development Tools](#) category:

Click to view products by [Maxim](#) manufacturer:

Other Similar products are found below :

[EVB-EP5348UI](#) [MIC23451-AAAYFL EV](#) [MIC5281YMME EV](#) [124352-HMC860LP3E](#) [DA9063-EVAL](#) [ADP122-3.3-EVALZ](#) [ADP130-0.8-EVALZ](#) [ADP130-1.8-EVALZ](#) [ADP1740-1.5-EVALZ](#) [ADP1870-0.3-EVALZ](#) [ADP1874-0.3-EVALZ](#) [ADP199CB-EVALZ](#) [ADP2102-1.25-EVALZ](#) [ADP2102-1.875EVALZ](#) [ADP2102-1.8-EVALZ](#) [ADP2102-2-EVALZ](#) [ADP2102-3-EVALZ](#) [ADP2102-4-EVALZ](#) [AS3606-DB](#) [BQ25010EVM](#) [BQ3055EVM](#) [ISLUSBI2CKIT1Z](#) [LP38512TS-1.8EV](#) [EVAL-ADM1186-1MBZ](#) [EVAL-ADM1186-2MBZ](#) [ADP122UJZ-REDYKIT](#) [ADP166Z-REDYKIT](#) [ADP170-1.8-EVALZ](#) [ADP171-EVALZ](#) [ADP1853-EVALZ](#) [ADP1873-0.3-EVALZ](#) [ADP198CP-EVALZ](#) [ADP2102-1.0-EVALZ](#) [ADP2102-1-EVALZ](#) [ADP2107-1.8-EVALZ](#) [ADP5020CP-EVALZ](#) [CC-ACC-DBMX-51](#) [ATPL230A-EK](#) [MIC23250-S4YMT EV](#) [MIC26603YJL EV](#) [MIC33050-SYHL EV](#) [TPS60100EVM-131](#) [TPS65010EVM-230](#) [TPS71933-28EVM-213](#) [TPS72728YFFEVM-407](#) [TPS79318YEQEVM](#) [UCC28810EVM-002](#) [XILINXPWR-083](#) [LMR22007YMINI-EVM](#) [LP38501ATJ-EV](#)