

## MAX17552 5V Output Evaluation Kit (TDFN)

## Evaluates: MAX17552 (TDFN) in 5V Output Voltage Applications

### General Description

The MAX17552 5V evaluation kit (EV kit) (TDFN) is a fully assembled and tested circuit board that demonstrates the performance of the MAX17552 60V, 100mA ultra-small, high-efficiency, synchronous step-down DC-DC converter in a 10-pin TDFN package. The EV kit operates over a wide input-voltage range of 6V to 60V and provides up to 100mA load current at 5V output. It draws only 26 $\mu$ A supply current under no-load conditions (EN/UVLO connected to  $V_{IN}$ ). The EV kit is programmed to switch at a frequency of 220kHz and delivers a peak efficiency of 93% with the supplied components. The device is simple to use and easily configurable with minimal external components. It features cycle-by-cycle peak current limit protection, undervoltage lockout, and thermal shutdown.

The EV kit comes installed with the MAX17552ATB+ in a 10-pin (3mm x 2mm) lead(Pb)-free/RoHS-compliant TDFN package.

### Features

- Wide 6V to 60V Input Voltage Range
- 5V Output, 100mA Continuous Current
- 93% Peak Efficiency
- 26 $\mu$ A No Load Supply Current
- Enable/UVLO Input, Resistor-Programmable UVLO Threshold
- Internal or Programmable Soft-Start
- Selectable PWM and PFM Modes of Operation
- Open-Drain  $\overline{\text{RESET}}$  Output
- Overcurrent Protection
- Overtemperature Protection
- Proven PCB Layout
- Fully Assembled and Tested

**Ordering Information** appears at end of data sheet.

TDFN is a registered trademark of Maxim Integrated Products, Inc.

### Quick Start

#### Recommended Equipment

- MAX17552 5V EV kit (TDFN)
- 60V adjustable, 0.5A DC power supply
- Load capable of sinking 100mA at 5V
- Two digital multimeters (DMM)

#### Procedure

The EV kit is fully assembled and tested. Follow the steps below to verify board operation.

**Caution: Do not turn on the power supply until all connections are completed.**

1. Set the input voltage to 24V and disable the power supply.
2. Connect the positive terminal of the power supply to the VIN PCB pad and the negative terminal to the nearest GND PCB pad.
3. Connect the positive terminal of the load to the VOUT PCB pad and the negative terminal to the nearest GND PCB pad.
4. Connect one DMM across VOUT PCB pad and the nearest GND PCB pad, and another DMM across the RESET PCB pad and the GND PCB pad.
5. Verify that shunts are installed on jumpers JU1 and JU2. See [Table 1](#) for details.
6. Select the shunt position on JU3 according to the intended mode of operation. See [Table 2](#) for details.
7. Turn on the input power supply and enable the load.
8. Verify that the DMM across the output terminals displays 5V.
9. Verify that the DMM across the  $\overline{\text{RESET}}$  PCB pad and GND PCB displays 5V.
10. Vary the input voltage between 6V and 60V and vary the load current from 1mA to 100mA. Verify that output voltage is 5V with respect to GND.
11. Reduce the input voltage to 5.3V.
12. Verify that both the DMMs display 0V.
13. Disable the input power supply.

**Note:** While performing an output short-circuit test, it is possible for the ceramic output capacitor to oscillate with the wiring inductance between the capacitor and short-circuited load, and thereby cause the absolute maximum rating of the  $V_{OUT}$  pin (-0.3V) to be exceeded. The resistor (R7) and the capacitor (C5) are included on this evaluation kit to protect against unintentional violation of the above mentioned rating. In the actual system design, parasitic board or wiring inductance should be minimized and the output-voltage waveform under short-circuit operation should be verified to ensure that the absolute maximum rating of the  $V_{OUT}$  pin is not exceeded.

# MAX17552 5V Output Evaluation Kit (TDFN)

# Evaluates: MAX17552 (TDFN) in 5V Output Voltage Applications

## Detailed Description

The MAX17552 5V EV kit (TDFN) is a fully assembled and tested circuit board that demonstrates the performance of the MAX17552 60V, 100mA ultra-small, high-efficiency, synchronous step-down DC-DC converter in a 10-pin TDFN package. The EV kit operates over a wide input voltage range of 6V to 60V and provides up to 100mA load current at 5V output. It draws only 26µA supply current under no-load conditions (EN/UVLO connected to VIN). The EV kit is programmed to switch at a frequency of 220kHz and delivers a peak efficiency of 93% with the supplied components. The device is simple to use and easily configurable with minimal external components. It features cycle-by-cycle peak current limit protection, undervoltage lockout, and thermal shutdown.

The EV kit includes an EN/UVLO PCB pad and jumpers JU1 and JU2 to enable control of the converter output. The MODE PCB pad and jumper JU3 are provided for selecting the mode of operation of the converter. A  $\overline{\text{RESET}}$  PCB pad is available for monitoring the status of the converter. The RT/SYNC PCB pad can be used to synchronize the EV kit to an external clock.

### Enable/Undervoltage Lockout Programming (EN/UVLO)

The EN/UVLO PCB pad on the EV kit serves as an on/off control while also allowing the user to program the input undervoltage lockout (UVLO) threshold. Jumpers JU1 and

JU2 configure the EV kit's output for turn-on/turn-off control. See [Table 1](#) for proper JU1, JU2 jumper configurations.

Additionally, resistors R1 and R2 are included to set the UVLO to a desired turn-on voltage. Refer to the *Setting the Input Undervoltage-Lockout Level* section in the MAX17552 IC data sheet for additional information on setting the UVLO threshold voltage.

### Open-Drain Reset Output ( $\overline{\text{RESET}}$ )

The EV kit provides a PCB pad to monitor the status of the converter.  $\overline{\text{RESET}}$  goes high when the output voltage rises above 95% (typ) of its nominal regulated output voltage.  $\overline{\text{RESET}}$  goes low when output voltage falls below 92% (typ) of its nominal regulated voltage.

### Mode Selection (MODE)

The EV kit includes a jumper (JU3) to select the mode of operation of the converter. Install a shunt across JU3 before powering up the EV kit to enable the forced-PWM operation. Keep JU3 open to enable the light-load PFM operation. See [Table 2](#) for proper JU3 settings.

### Soft-Start Input (SS)

The EV kit offers a fixed 5ms soft-start time. Connect the capacitor C4 to adjust the soft-start time ( $t_{SS}$ ). Use the following equation to determine the soft-start capacitance value ( $C_{SS}$ ).

$$C_{SS} = 6.25 \times t_{SS}$$

where  $t_{SS}$  is in milliseconds and  $C_{SS}$  is in nanofarads.

**Table 1. Converter EN/UVLO Jumpers (JU1, JU2) Settings**

SHUNT POSITION		EN/UVLO PIN	OUTPUT
JU1	JU2		
1-2	Open	Connected to VIN	Enabled
Open	1-2	Connected to GND	Disabled
1-2*	1-2*	Connected to midpoint of R1, R2 resistor-divider	Enabled at VIN ≥ 6V

\*Default position.

**Table 2. Mode Selection Jumper (JU3) Settings**

SHUNT POSITION	MODE PIN	MODE OF OPERATION
1-2	Connected to GND	Forced PWM
Open*	Unconnected	PFM

\*Default position.

# MAX17552 5V Output Evaluation Kit (TDFN)

# Evaluates: MAX17552 (TDFN) in 5V Output Voltage Applications

## External Clock Synchronization (RT/SYNC)

The EV kit provides a PCB pad to synchronize the MAX17552 to an optional external clock. Apply the external clock to the RT/SYNC PCB pad through an AC-coupling capacitor. Refer to the *External Synchronization* section in the MAX17552 IC data sheet for additional information on configuring the external clock and selecting the AC-coupling capacitor.

## Hot Plug-in and Long Input Cables

The MAX17552 5V EV kit (TDFN) PCB layout provides an optional electrolytic capacitor ( $C1 = 22\mu\text{F}/100\text{V}$ ). This capacitor limits the peak voltage at the input of the converter when the DC input source is Hot Plugged to the EV kit input terminals with long input cables. The equivalent series resistance (ESR) of the electrolytic capacitor dampens the oscillations caused by interaction of the inductance of the long input cables and the ceramic capacitors at the converter's input.

## EV Kit Performance Report

( $V_{IN} = 24\text{V}$ ,  $f_{SW} = 220\text{kHz}$ ,  $T_A = +25^\circ\text{C}$ , unless otherwise noted)

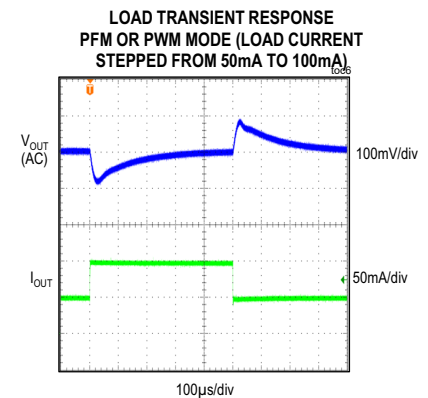
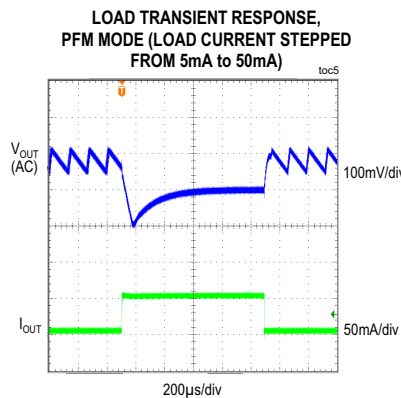
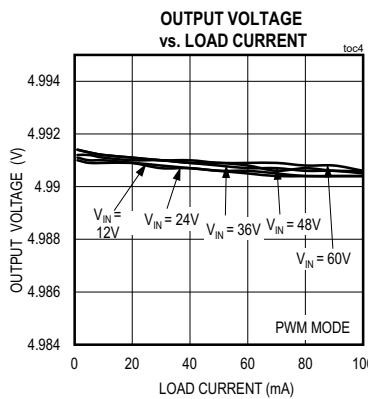
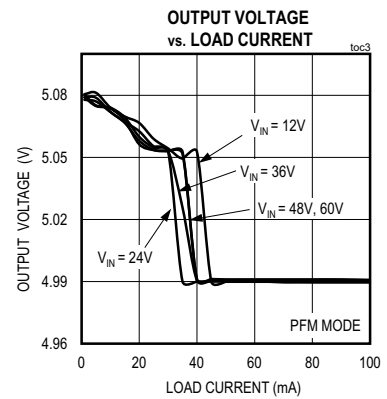
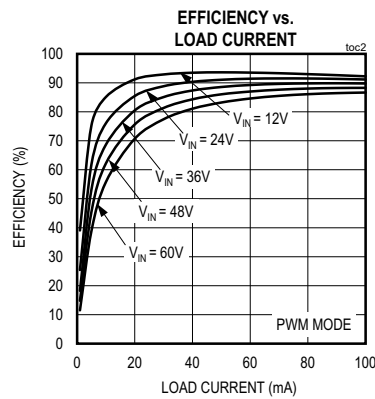
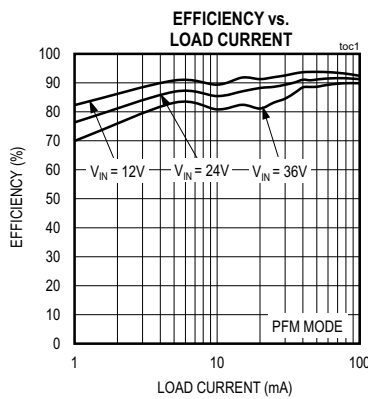

# MAX17552 5V Output Evaluation Kit (TDFN)

Evaluates: MAX17552 (TDFN) in 5V Output Voltage Applications

## EV Kit Performance Report (continued)

( $V_{IN} = 24V$ ,  $f_{SW} = 220kHz$ ,  $T_A = +25^{\circ}C$ , unless otherwise noted)

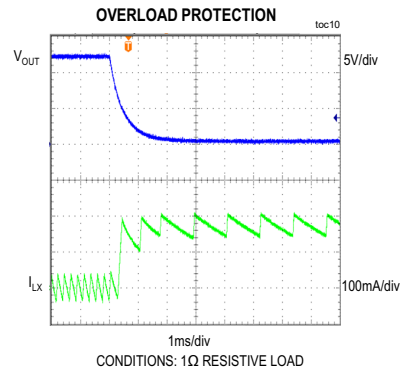
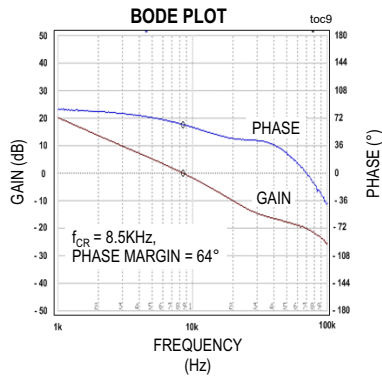
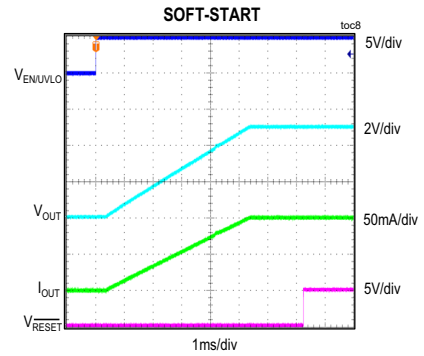
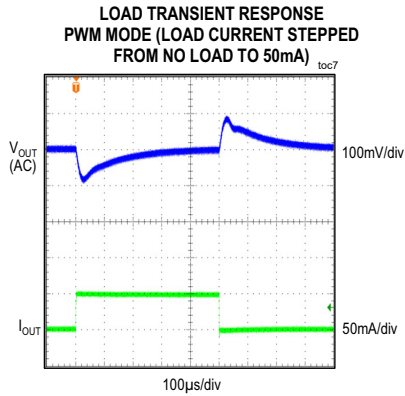

# MAX17552 5V Output Evaluation Kit (TDFN)

Evaluates: MAX17552 (TDFN)  
in 5V Output Voltage Applications

## MAX17552 5V EV Kit (TDFN) Bill Of Materials

DESIGNATION	QTY	DESCRIPTION
C1	1	22 $\mu$ F, 100V electrolytic capacitor (8.3mm x 8.3mm) Panasonic EEVFK2A220P
C2	1	1 $\mu$ F $\pm$ 10%, 100V X7R ceramic capacitor (1206) Murata GRM31CR72A105K
C3	1	10 $\mu$ F $\pm$ 10%, 6.3V X7R ceramic capacitor (1206) Murata GRM31CR70J106K
C4	0	Not installed, ceramic capacitor
C5	1	0.22 $\mu$ F $\pm$ 10%, 16V X7R ceramic capacitor (0402) Murata GRM155R71C224K
JU1–JU3	3	2-pin headers
L1	1	220 $\mu$ H, 235mA inductor Coilcraft, Inc. LPS5030-224ML

DESIGNATION	QTY	DESCRIPTION
R1	1	3.01M $\Omega$ $\pm$ 1% resistor (0402)
R2	1	787k $\Omega$ $\pm$ 1% resistor (0402)
R3	1	191k $\Omega$ $\pm$ 1% resistor (0402)
R4	1	261k $\Omega$ $\pm$ 1% resistor (0402)
R5	1	49.9k $\Omega$ $\pm$ 1% resistor (0402)
R6	1	100k $\Omega$ $\pm$ 1% resistor (0402)
R7	1	22.1 $\Omega$ $\pm$ 1% resistor (0402)
U1	1	60V, 100mA, ultra-small, high-efficiency, synchronous step-down DC-DC converter with 22 $\mu$ A no-load supply current (10 TDFN-EP*) Maxim MAX17552ATB+
—	3	Shunts
—	1	PCB: MAX17552ATB-5V EVALUATION KIT

## Component Suppliers

SUPPLIER	WEBSITE
Coilcraft	<a href="http://www.coilcraft.com">www.coilcraft.com</a>
Murata Americas	<a href="http://www.murata.com">www.murata.com</a>
Panasonic	<a href="http://www.panasonic.com">www.panasonic.com</a>
TDK corp.	<a href="http://www.tdk.com">www.tdk.com</a>

**Note:** Indicate that you are using the MAX17552ATB when contacting these component suppliers.

## Ordering Information

PART	TYPE
MAX17552ATBEVKIT#	EV KIT

#Denotes RoHS compliance.

MAX17552 5V Output  
Evaluation Kit (TDFN)

Evaluates: MAX17552 (TDFN)  
in 5V Output Voltage Applications

MAX17552 5V EV Kit (TDFN) Schematic

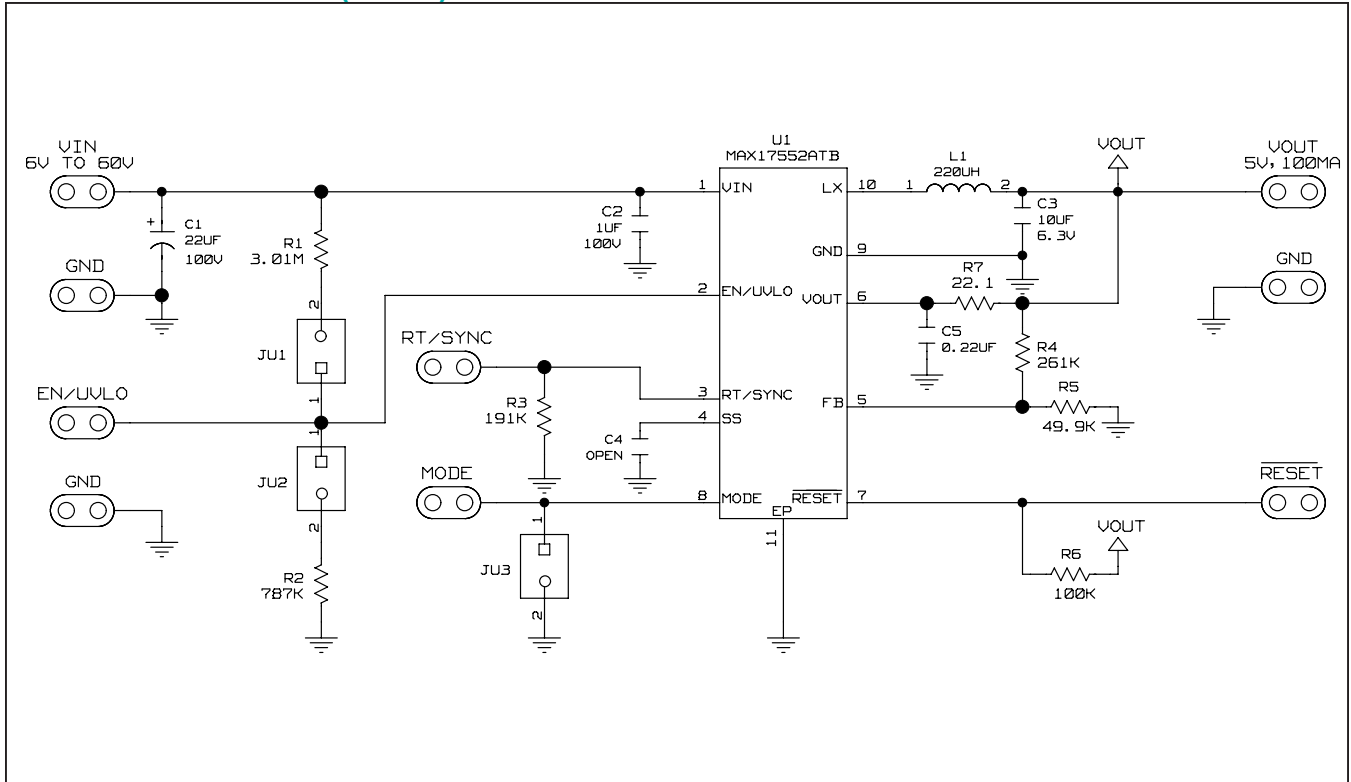

MAX17552 5V Output  
Evaluation Kit (TDFN)

Evaluates: MAX17552 (TDFN)  
in 5V Output Voltage Applications

MAX17552 5V EV Kit (TDFN) PCB Layout

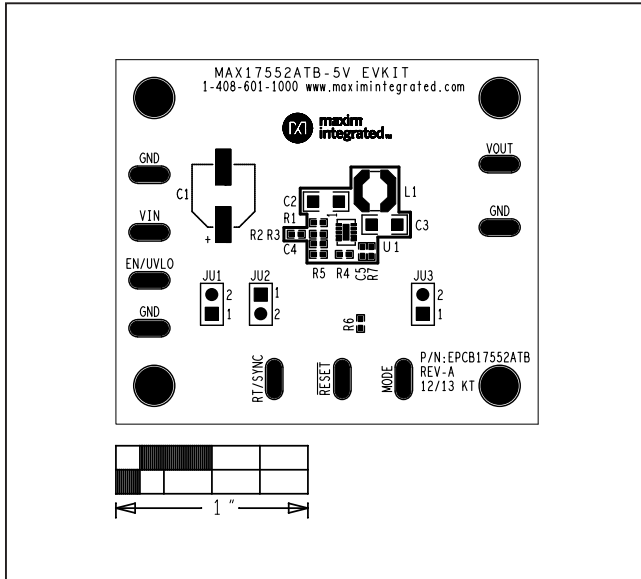

MAX17552 5V EV Kit (TDFN)—Silk Top

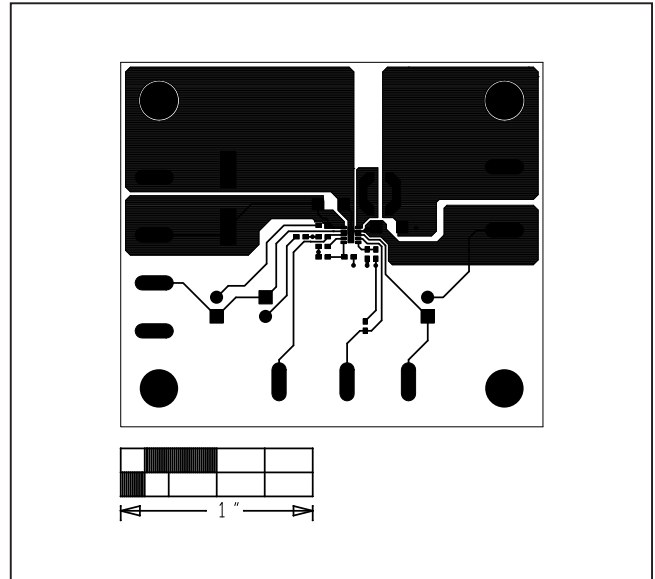

MAX17552 5V EV Kit (TDFN)—Top Layer

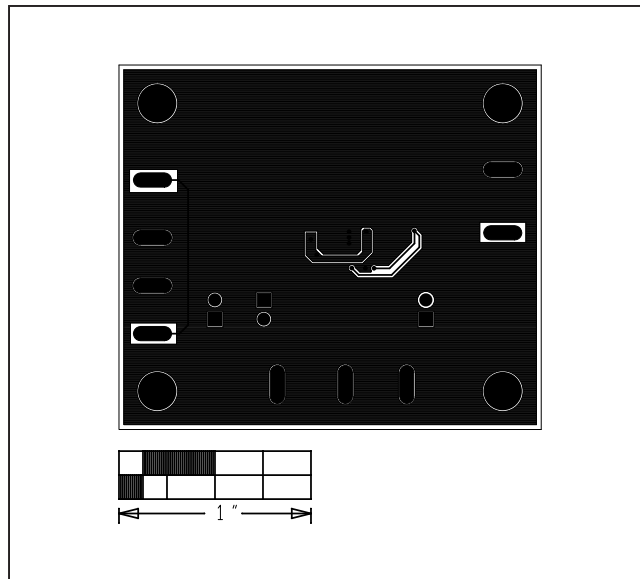

MAX17552 5V EV Kit (TDFN)—Bottom Layer

## Revision History

REVISION NUMBER	REVISION DATE	DESCRIPTION	PAGES CHANGED
0	1/14	Initial release	—
1	4/14	Updated <i>Ordering Information</i> table	7
2	11/20	Updated the <i>General Description</i> and the title	1–8
3	7/21	Updated <i>Features</i> , <i>Quick Start</i> , and <i>Detailed Description</i> sections, TOCs, <i>Component Suppliers</i> table, title, and PCB layout captions; moved <i>Ordering Information</i> table to page 5	1–7

For pricing, delivery, and ordering information, please visit Maxim Integrated's online storefront at <https://www.maximintegrated.com/en/storefront/storefront.html>.

Maxim Integrated cannot assume responsibility for use of any circuitry other than circuitry entirely embodied in a Maxim Integrated product. No circuit patent licenses are implied. Maxim Integrated reserves the right to change the circuitry and specifications without notice at any time.



## X-ON Electronics

Largest Supplier of Electrical and Electronic Components

*Click to view similar products for [Power Management IC Development Tools](#) category:*

*Click to view products by [Maxim](#) manufacturer:*

Other Similar products are found below :

[EVB-EP5348UI](#) [MIC23451-AAAYFL EV](#) [MIC5281YMME EV](#) [124352-HMC860LP3E](#) [DA9063-EVAL](#) [ADP122-3.3-EVALZ](#) [ADP130-0.8-EVALZ](#) [ADP130-1.8-EVALZ](#) [ADP1740-1.5-EVALZ](#) [ADP1870-0.3-EVALZ](#) [ADP1874-0.3-EVALZ](#) [ADP199CB-EVALZ](#) [ADP2102-1.25-EVALZ](#) [ADP2102-1.875EVALZ](#) [ADP2102-1.8-EVALZ](#) [ADP2102-2-EVALZ](#) [ADP2102-3-EVALZ](#) [ADP2102-4-EVALZ](#) [AS3606-DB](#) [BQ25010EVM](#) [BQ3055EVM](#) [ISLUSBI2CKIT1Z](#) [LP38512TS-1.8EV](#) [EVAL-ADM1186-1MBZ](#) [EVAL-ADM1186-2MBZ](#) [ADP122UJZ-REDYKIT](#) [ADP166Z-REDYKIT](#) [ADP170-1.8-EVALZ](#) [ADP171-EVALZ](#) [ADP1853-EVALZ](#) [ADP1873-0.3-EVALZ](#) [ADP198CP-EVALZ](#) [ADP2102-1.0-EVALZ](#) [ADP2102-1-EVALZ](#) [ADP2107-1.8-EVALZ](#) [ADP5020CP-EVALZ](#) [CC-ACC-DBMX-51](#) [ATPL230A-EK](#) [MIC23250-S4YMT EV](#) [MIC26603YJL EV](#) [MIC33050-SYHL EV](#) [TPS60100EVM-131](#) [TPS65010EVM-230](#) [TPS71933-28EVM-213](#) [TPS72728YFFEVM-407](#) [TPS79318YEQEVM](#) [UCC28810EVM-002](#) [XILINXPWR-083](#) [LMR22007YMINI-EVM](#) [LP38501ATJ-EV](#)