

General Description

The MAX17597 evaluation kit (EV kit) is a fully assembled and tested circuit board that demonstrates an isolated 20W flyback DC-DC converter. The circuit uses the device's peak-current-mode controller in a 16-pin TQFN package with an exposed pad. The EV kit demonstrates the IC's cycle-by-cycle current-limit, soft-start, and EN/UVLO features.

The EV kit circuit output is configured for an isolated 24V and provides up to 833mA of output current. The EV kit is configured to operate at a 200kHz switching frequency. An optocoupler, along with the transformer, provides galvanic isolation between input and output, up to 1500V_{RMS}.

Features

- 18V to 36V Input Range
- Isolated Output: 24V DC at 20W
- Cycle-by-Cycle Current Limit
- Resistor Programmable UVLO/OVI Threshold
- Low-Cost Flyback Design
- Galvanic Isolation Up to 1500V_{RMS}
- Proven PCB Layout
- Fully Assembled and Tested

Ordering Information appears at end of data sheet.

Quick Start

Recommended Equipment

- One 18V to 36V DC, 2A power supply
- Electronic load
- Four digital multimeters (DMM)
- MAX17597-24V EVKITA#

Warning:

- Do not turn on the power supply until all connections are completed.
- Wear protective eye gear at all times.
- Do not touch any part of the circuit with bare hands or conductive materials when powered up.
- Make sure all high-voltage capacitors are fully discharged before handling. Allow 5 minutes after disconnecting the input power source before touching circuit parts.

Equipment Setup and Test Procedure

- 1) Set the power supply to +24VDC. Disable the power-supply output.
- 2) Connect the positive terminal of the power supply to the VIN PCB pad and the negative terminal to the nearest PGND PCB pad. Connect the positive terminal of the electronic load to the VOUT PCB pad and the negative terminal to the nearest GND0 PCB pad.
- 3) Set the electronic load to constant-current mode and disable the electronic load.
- 4) Connect a DMM configured in voltmeter mode across the VOUT PCB pad and the nearest GND0 PCB pad.
- 5) Connect another DMM configured in voltmeter mode across the VOUT PCB pad and the GND0 PCB pad.
- 6) Enable the power supply.
- 7) Enable the load and adjust the current to 833mA.
- 8) Verify that the output voltmeter displays 24V
- 9) If required, vary the input voltage from 18V to 36V, the load current from 0 to 833mA, and verify that the output voltage is 24V.

Detailed Description

The MAX17597 EV kit provides a proven design to evaluate the high-efficiency, DC-DC flyback converter in a space-saving 16-pin TQFN package. The EV kit is configured for a 24V output voltage that can supply up to 840mA of current. The EV kit features a 200kHz fixed switching frequency for optimum efficiency and component size.

This EV kit uses the peak-current-mode, pulse-width-modulating (PWM) controller IC in a 16-pin TQFN package with an exposed pad. This PWM controller varies the duty cycle to compensate for the variation in input voltage (V_{IN}) and the output load to maintain a constant output voltage. The duty cycle determines the on/off duration of the MOSFET (Q1).

The detailed description of flyback-design methodology, as well as the calculations for component value selection, are described in *Application Note 5504, Designing Flyback Converters Using Peak-Current-Mode Controllers*. The details of soft-start time programming, programming output voltage, peak-current limit setting, switching frequency setting, and the EN/UVLO, OVI settings are described in the MAX17595–MAX17597 IC data sheet.

Note: The EV kit is shipped with the frequency dithering disabled and the DITHER/SYNC pin shorted to SGND by a 0 Ω resistor. To set the desired frequency dither, replace resistor R23 with a capacitor of appropriate value, as detailed in the MAX17595–MAX17597 IC data sheet. The DITHER/SYNC PCB pad is available for monitoring the signal at the DITHER/SYNC pin.

EV Kit Performance Report

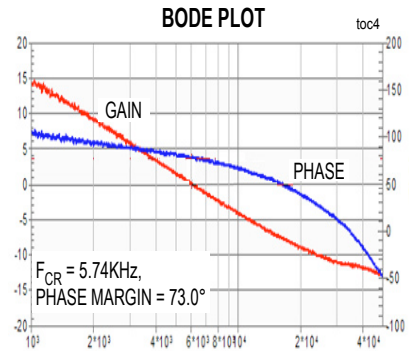
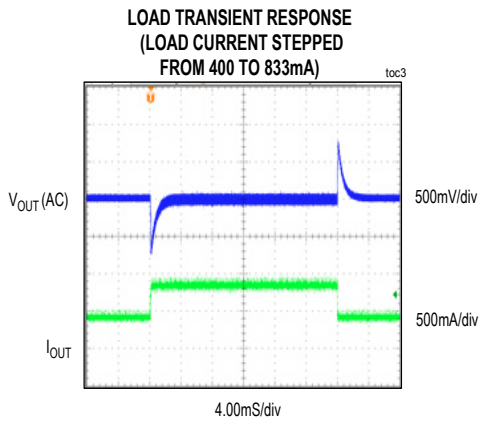
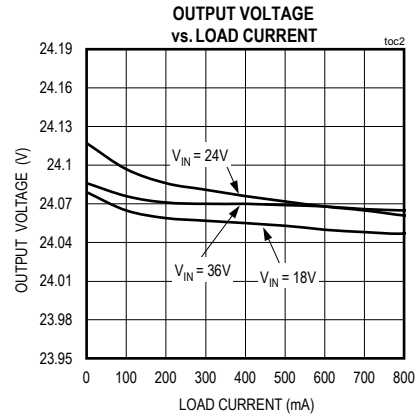
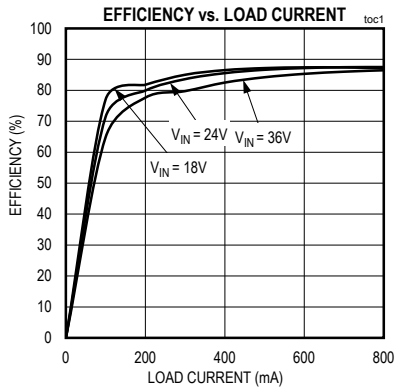

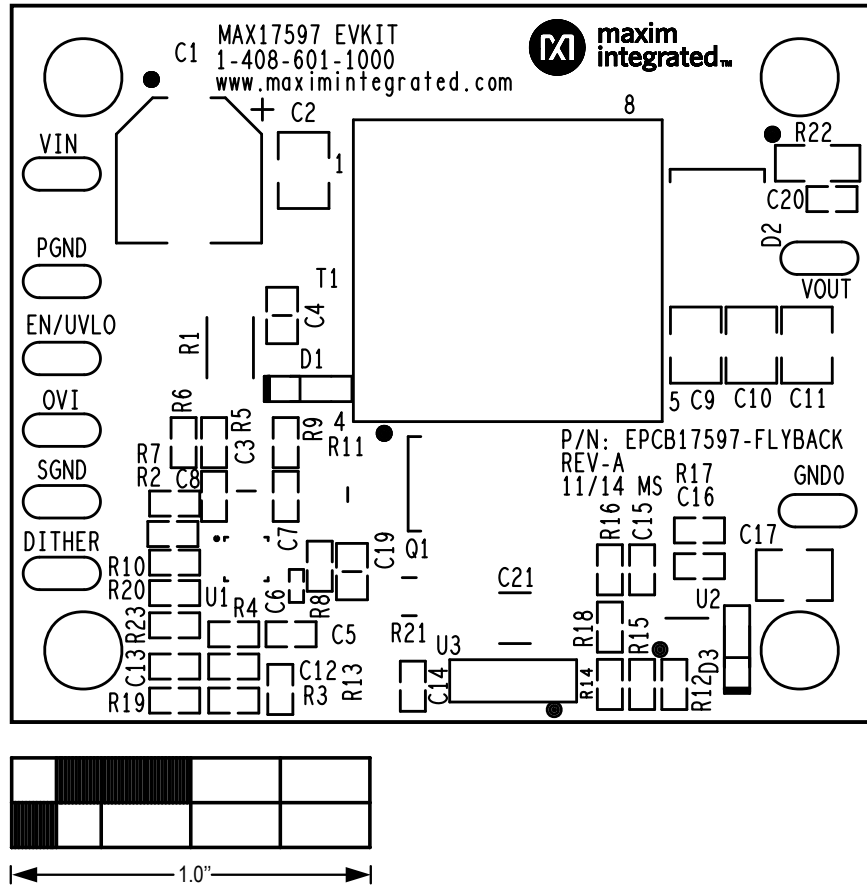

Figure 1. MAX17597 EV Kit Component Placement Guide—Component Side

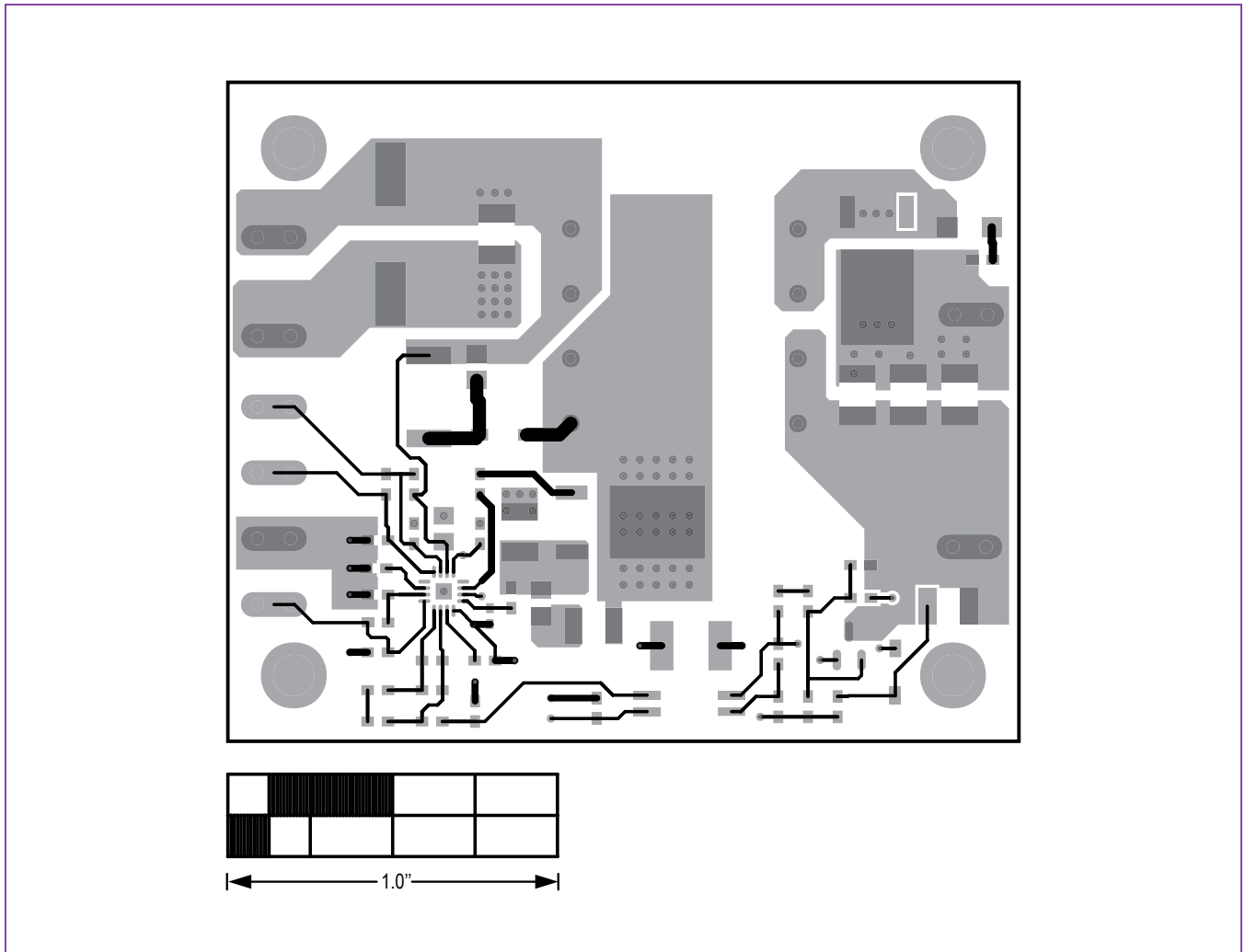

Figure 2. MAX17597 EV Kit PCB Layout—Component Side

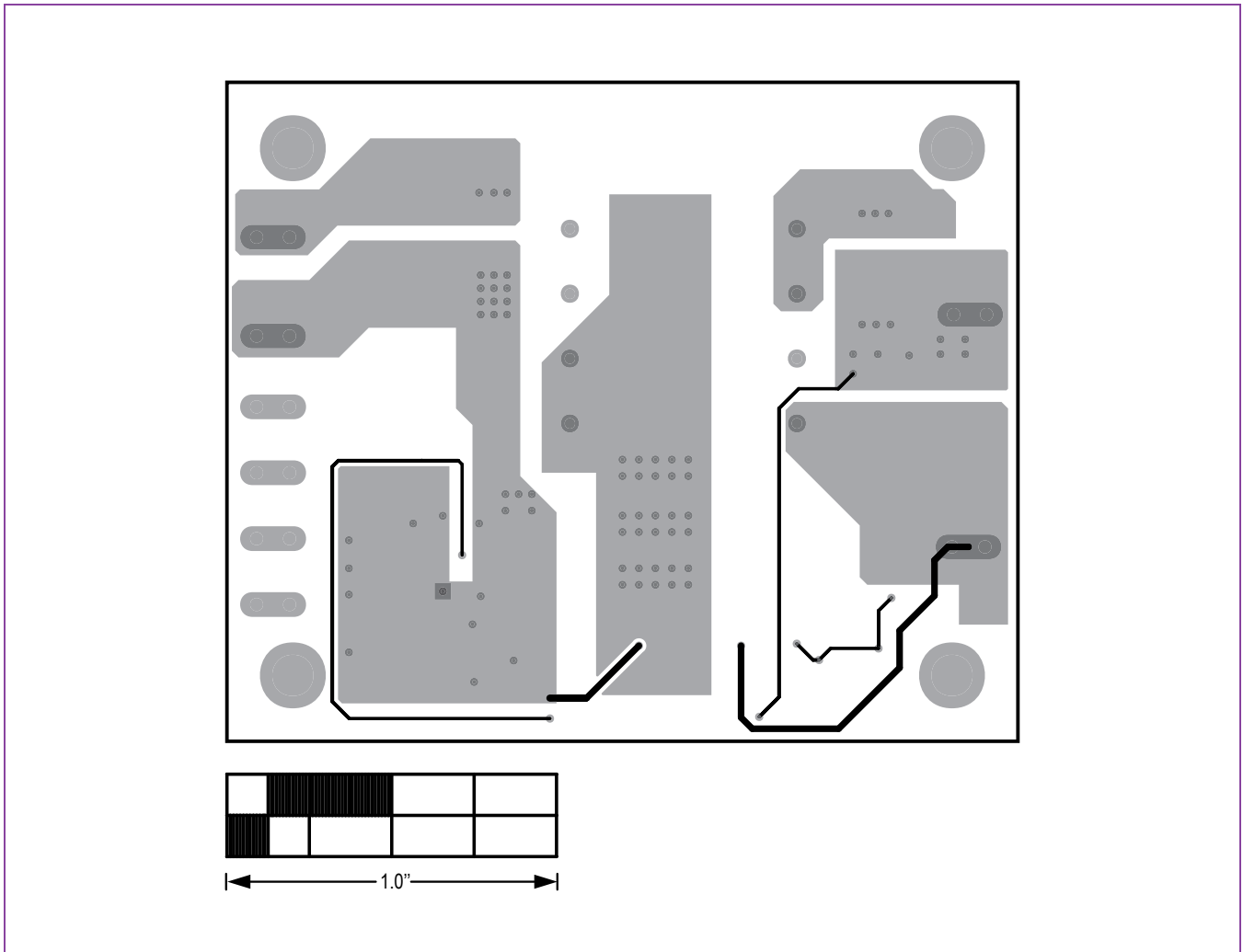

Figure 3. MAX17597 EV Kit PCB Layout—Solder Side

Component Suppliers

SUPPLIER	WEBSITE
Coilcraft, Inc.	www.coilcraft.com
Murata Americas	www.murata.com
Panasonic Corp.	www.panasonic.com

Note: Indicate that you are using the MAX17597 when contacting these component suppliers.

Ordering Information

PART	TYPE
MAX17597FBEVKIT#	EV Kit

#Denotes RoHS compliant.

Component List

See the links below for component information and schematics:

- [MAX17597 EV BOM](#)
- [MAX17597 EV Schematic](#)

Revision History

REVISION NUMBER	REVISION DATE	DESCRIPTION	PAGES CHANGED
0	7/15	Initial release	—

For pricing, delivery, and ordering information, please contact Maxim Direct at 1-888-629-4642, or visit Maxim Integrated's website at www.maximintegrated.com.

Maxim Integrated cannot assume responsibility for use of any circuitry other than circuitry entirely embodied in a Maxim Integrated product. No circuit patent licenses are implied. Maxim Integrated reserves the right to change the circuitry and specifications without notice at any time.

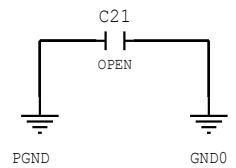
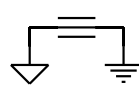
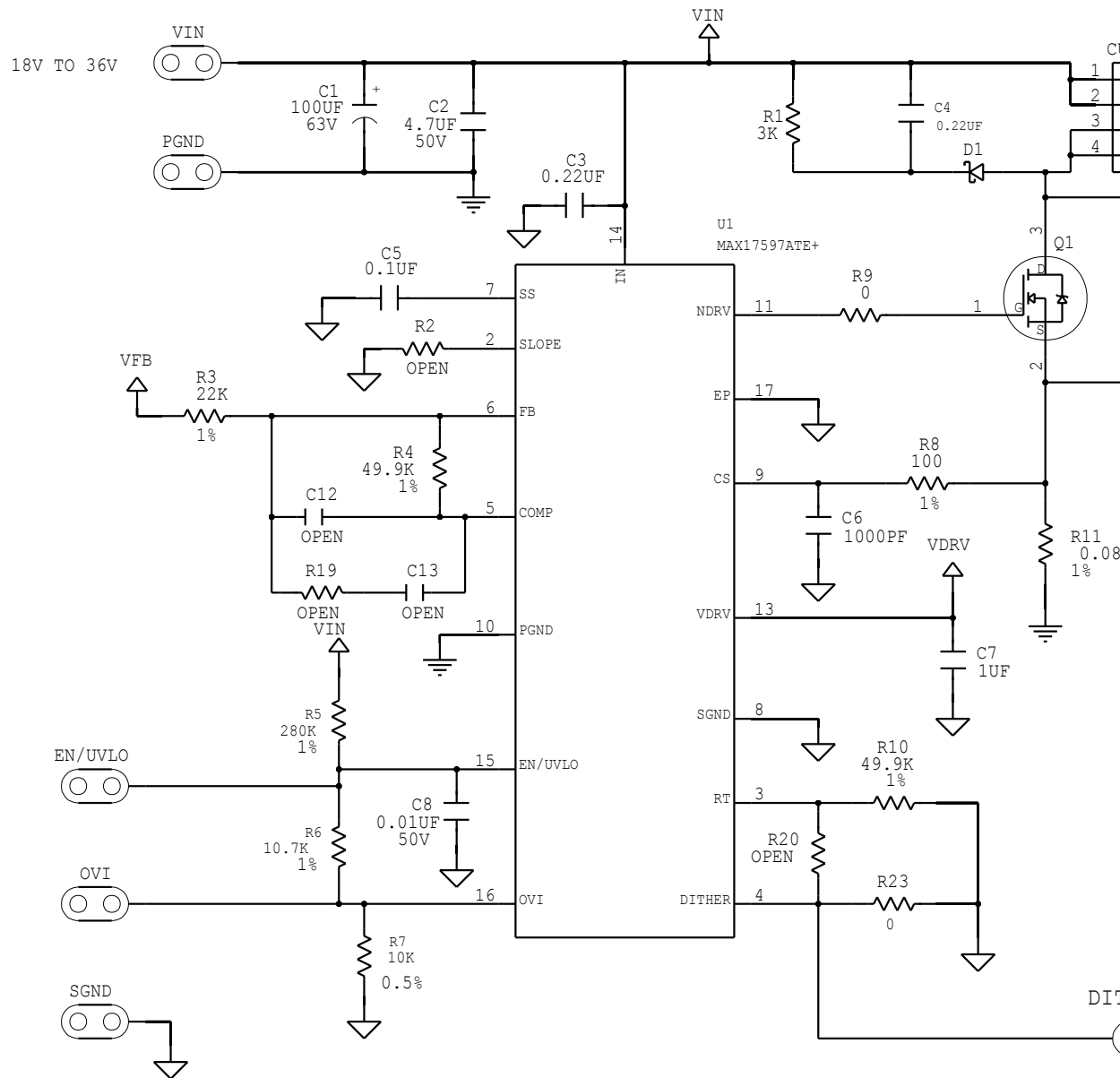

BILL OF MATERIALS (BOM) - REVISION 5/15

S NO	Designation	Qty	Description	Manufacturer Partnumber-1	Manufacturer Partnumber-2	Manufacturer Partnumber-3	Manufacturer Partnumber-4	Manufacturer Partnumber-5
1	C1	1	100µF ±20%, 63V, ALUMINUM-ELECTROLYTIC (SMT (CASE_G))	PANASONIC EEE-FK1J101P				
2	C2	1	4.7µF±10% 50V X7R Ceramic capacitor (1210)	MURATA GRM32ER71H475KA88K	KEMET C1210C475K5RAC			
3	C3	1	0.22µF±10% 50V X7R Ceramic capacitor (0805)	MURATA GRM21BR71H224KA	KEMET C0805C224K5RAC	TDK CGJ4J2X7R1H224K125AA		
4	C4	1	0.22µF±10% 100V X7R Ceramic capacitor (0805)	MURATA GRM21AR72A224KAC5	KEMET C0805C224K1RAC			
5	C5,C14	2	0.1µF±10% 16V X7R Ceramic capacitor (0603)	MURATA GRM188R71C104K	KEMET C0603C104K4RA	TDK C1608X7R1C104K	MURATA GCM188R71C104K A37	VENKEL C0603X7R160-104KNE
6	C6	1	1000pF±5%,50V,X7R ceramic capacitor (0402)	MURATA GRM155R71H102JA01D				
7	C7	1	1µF±10% 25V X7R Ceramic capacitor (0603)	MURATA GRM188R71E105KA12D	MURATA CGA3E1X7R1E105K			
8	C8	1	0.01µF±10% 50V X7R Ceramic capacitor (0603)	MURATA GRM188R71H103K	KEMET C0603C103K5RAC	VENKEL LTD C0603X7R500-103KNE		
9	C9-C11,C17	4	10µF±10% 50V X7R Ceramic capacitor (1210)	MURATA GRM32ER71H106KA12L	MURATA CL32B106KBJNNN			
10	C15	1	0.1µF±10% 50V X7R Ceramic capacitor (0603)	PANASONIC ECJ-1VB1H104K				
11	C16	1	680pF±10%,50V,X7R ceramic capacitor (0603)	MURATA GRM188R71H681KA01				
12	C19	1	390pF±5% 100V X7R Ceramic capacitor (0805)	MURATA GRM2165C2A391JA01				
13	C20	1	220pF±10%,250V,X7R ceramic capacitor (0603)	MURATA GRM188R72E221K				
14	D1	1	100V/1A,SMT (SOD-123FL)	MICRO COMMERCIAL SMD110PL				
15	D2	1	200V /4A, DPAK	MICROELECTRONICS STTH4R02B				
16	D3	1	100V/0.3A,SMT (SOD-123)	DIODES INCORPORATED 1N4148W-7-F				
17	Q1	1	100V/63A/140W, POWER MOSFET(DPAK)	INTERNATIONAL RECTIFIER IRLR3110ZTRPBF				
18	R1	1	3kΩ ± 5 %,1.0W resistor (2512)	VISHAY DALE CRCW25123K00JN				
19	R3	1	22kΩ ±1 %0.1W resistor (0603)	VISHAY DALE CRCW060322K0FK				
20	R4,R10	2	49.9kΩ ± 1% 0.1W resistor (0603)	VISHAY DALE CRCW060349K9FK	PANASONIC ERJ-3EKF4992V			
21	R5	1	280kΩ ± 1% 0.1W resistor (0603)	VISHAY DALE CRCW0603280KFK				
22	R6	1	10.7kΩ ± 1% 0.1W resistor (0603)	VISHAY DALE CRCW060310K7FK	PANASONIC ERJ-3EKF1072V			
23	R7,R12	2	10kΩ ± 0.5% 0.063W resistor (0603)	PANASONIC ERJ-3RBD1002V				
24	R8	1	100Ω ± 1% 0.1W resistor (0603)	VISHAY DALE CRCW0603100RFK	PANASONIC ERJ-3EKF1000V			
25	R9	1	0Ω ± 0% 0.1W resistor (0603)	VISHAY DALE CRCW06030000ZS	VISHAY DALE MCR03EZPJ000	VISHAY DALE ERJ-3GEY0R00V		
26	R11	1	0.082Ω ± 1% 0.5W resistor (1210)	SEMICONDUCTOR MCR25JZHFSR082				
27	R13	1	470Ω ± 1% 0.1W resistor (0603)	VISHAY DALE CRCW0603470RFK				
28	R14	1	7.68kΩ ± 1% 0.1W resistor (0603)	VISHAY DALE CRCW06037K68FK				
29	R15	1	3.9kΩ ± 1% 0.1W resistor (0603)	VISHAY DALE CRCW06033K90FK				
30	R16	1	2.55kΩ ± 1% 0.1W resistor (0603)	VISHAY DALE CRCW06032K55FK				
31	R17	1	453Ω ± 1% 0.1W resistor (0603)	PANASONIC ERJ-3EKF4530V				

32	R21	1	470Ω ± 5% 0.5W resistor (1210)	PANASONIC ERJ-14YJ470U			
33	R22	1	100Ω ± 5% 0.66W resistor (1206)	PANASONIC ERJP08J101V			
34	R23	1	0Ω ± 5% resistor (0603)	SAMSUNG ELECTRONICS RC1608J000CS	BOURNS CR0603-J-000ELF	YAGEO PH RC0603JR-070RL	
35	T1	1	33μH, (3,4-1,2):(7,8-5,6)=0.5416:1	COILCRAFT CU8758-AL			
36	U1	1	MAX17597 TQFN16-EP 3X3	MAX17597ATE+			
37	U2	1	0.1A ADJUSTABLE PRECISION SHUNT REGULATOR(SOT-23)	TEXAS INSTRUMENTS TL431AQDBZRQ1			
38	U3	1	8V/0.05A,0.2W PHOTOTRANSISTOR OPTOCOUPLER (NSOIC4)	AVAGO TECHNOLOGIES ACPL-217-56AE			

DO NOT PURCHASE(DNP)							
1	C12,C13	2	N/A				
2	C21	1	N/A				
3	R2,R18-R20	4	N/A				

X-ON Electronics

Largest Supplier of Electrical and Electronic Components

Click to view similar products for [Power Management IC Development Tools](#) category:

Click to view products by [Maxim](#) manufacturer:

Other Similar products are found below :

[EVB-EP5348UI](#) [MIC23451-AAAYFL EV](#) [MIC5281YMME EV](#) [124352-HMC860LP3E](#) [DA9063-EVAL](#) [ADP122-3.3-EVALZ](#) [ADP130-0.8-EVALZ](#) [ADP130-1.8-EVALZ](#) [ADP1740-1.5-EVALZ](#) [ADP1870-0.3-EVALZ](#) [ADP1874-0.3-EVALZ](#) [ADP199CB-EVALZ](#) [ADP2102-1.25-EVALZ](#) [ADP2102-1.875EVALZ](#) [ADP2102-1.8-EVALZ](#) [ADP2102-2-EVALZ](#) [ADP2102-3-EVALZ](#) [ADP2102-4-EVALZ](#) [AS3606-DB](#) [BQ25010EVM](#) [BQ3055EVM](#) [ISLUSBI2CKIT1Z](#) [LP38512TS-1.8EV](#) [EVAL-ADM1186-1MBZ](#) [EVAL-ADM1186-2MBZ](#) [ADP122UJZ-REDYKIT](#) [ADP166Z-REDYKIT](#) [ADP170-1.8-EVALZ](#) [ADP171-EVALZ](#) [ADP1853-EVALZ](#) [ADP1873-0.3-EVALZ](#) [ADP198CP-EVALZ](#) [ADP2102-1.0-EVALZ](#) [ADP2102-1-EVALZ](#) [ADP2107-1.8-EVALZ](#) [ADP5020CP-EVALZ](#) [CC-ACC-DBMX-51](#) [ATPL230A-EK](#) [MIC23250-S4YMT EV](#) [MIC26603YJL EV](#) [MIC33050-SYHL EV](#) [TPS60100EVM-131](#) [TPS65010EVM-230](#) [TPS71933-28EVM-213](#) [TPS72728YFFEVM-407](#) [TPS79318YEQEVM](#) [UCC28810EVM-002](#) [XILINXPWR-083](#) [LMR22007YMINI-EVM](#) [LP38501ATJ-EV](#)