

## MAX17634BEVKIT# Evaluation Kit

## Evaluates: MAX17634B 5V Output-Voltage Application

### General Description

The MAX17634BEVKIT# 5V output evaluation kit (EV kit) provides a proven design to evaluate the MAX17634B high-voltage, high-efficiency, synchronous step-down DC-DC converter. The EV kit is preset for 5V output at load currents of 4.25A and features a 400kHz switching frequency for optimum efficiency and component size. The EV kit features an adjustable input undervoltage lockout, adjustable soft-start, open-drain  $\overline{\text{RESET}}$  signal, and external clock synchronization. EV kit specifications, settings, features and benefits are highlighted. The EV kit layout is optimized for thermal performance. For more details about the IC benefits and features, refer to the MAX17634 data sheet.

### Features

- Wide 6.5V to 36V Input Range
- Programmed 5V Output, 4.25A Load Current
- 400kHz Switching Frequency
- EN/UVLO Input, Resistor-Programmable UVLO Threshold
- Programmed 1ms Soft-Start Time
- Selectable PWM, PFM, and DCM Modes
- Open-Drain  $\overline{\text{RESET}}$  Output Pulled Up To 5V of INTVCC
- Provision for External Frequency Synchronization
- Overcurrent and Overtemperature Protection
- Proven PCB Layout
- Fully Assembled and Tested

**Ordering Information** appears at end of data sheet.

### Quick Start

#### Recommended Equipment

- One MAX17634BEVKIT# EV kit
- One 0V to 36V DC, 5A power supply
- Load capable of sinking 4.25A current
- Digital voltmeter (DVM)

#### Equipment Setup and Test Procedure

The EV kit is fully assembled and tested. Follow the steps below to verify board operation:

**Caution: Do not turn on power supply until all connections are complete.**

- 1) Set the input power supply at a voltage between 6.5V and 36V. Disable the power supply.
- 2) Connect the positive terminal of the input power supply to the VIN PCB pad and the negative terminal to the nearest PGND pad. Connect the positive terminal of the 4.25A load to the VOUT pad and the negative terminal to the nearest PGND pad.
- 3) Connect a DVM across the VOUT pad and the nearest PGND pad.
- 4) Verify that shunts are not installed on jumper JU1 (see [Table 1](#) for details).
- 5) Select the shunt position on jumper JU2 according to the intended mode of operation (see [Table 2](#) for details).
- 6) Turn on the input power supply.
- 7) Enable the load.
- 8) Verify that the DVM displays 5V.
- 9) Connect the DVM across the  $\overline{\text{RESET}}$  pad and SGND. Verify that the DVM displays 5V.
- 10) Reduce the input voltage to 5V which is below the EN/UVLO falling threshold.
- 11) Connect the DVM across the VOUT pad and nearest PGND. Verify that the DVM displays 0V.
- 12) Connect the DVM across the  $\overline{\text{RESET}}$  pad and SGND. Verify that the DVM displays 0V.
- 13) Disable the input power supply.

### Detailed Description

The MAX17634BEVKIT# is designed to demonstrate the salient features of the MAX17634B. The EV kit includes an EN/UVLO pad and jumper JU1 to enable the output at a desired input voltage. The Jumper JU2 allows selection of a particular mode of operation based on light load performance requirements. The MODE/SYNC pin on jumper JU2 allows an external clock interface to synchronize the device. An additional RESET pad is available for monitoring the status of the output voltage.

### Soft-Start Programming

The EV kit offers an adjustable soft-start function to limit inrush current during startup. The soft-start time is adjusted by the value of external soft-start capacitor C3, connected between SS and SGND. The selected output capacitance (C<sub>SEL</sub>) and the output voltage (V<sub>OUT</sub>) determine the minimum value of C3, as shown by the following equation:

$$C3 \geq 28 \times 10^{-6} \times C_{SEL} \times V_{OUT}$$

The soft-start time (t<sub>SS</sub>) is related to the soft-start capacitor C3 by the following equation:

$$t_{SS} = \frac{C3}{5.55 \times 10^{-6}}$$

For example, in order to program a 1ms soft-start time, C3 should be 5600pF.

### Enable/Undervoltage-Lockout (EN/UVLO) Programming

The MAX17634 offers an Enable and adjustable input undervoltage lockout feature. In this EV kit, for normal operation, leave EN/UVLO jumper (JU1) open. When JU1 is left open, the MAX17634 is enabled when the input voltage rises above 6.4V. To disable MAX17634, install a jumper across pins 2–3 on JU1. See [Table 1](#) for JU1 settings. The EN/UVLO PCB pad on the EV kit supports external Enable/Disable control of the device. Leave JU1 open when external Enable/Disable control is desired. A potential divider formed by R1 and R2 sets the input voltage (V<sub>INU</sub>) above which the converter is enabled when JU1 is left open.

Choose R1 to be 3.32MΩ (max), and then calculate R2 as follows:

$$R2 = \frac{R1 \times 1.215}{(V_{INU} - 1.215)}$$

where V<sub>INU</sub> is the voltage at which the device is required to turn on, and R1 and R2 are in kΩ.

For more details about setting the undervoltage lockout level, refer to the MAX17634 data sheet.

### Mode Selection (MODE)

The EV kit provides a jumper (JU2) that allows the MAX17634 to operate in PWM, PFM, and DCM modes. [Table 2](#) shows the MODE SELECTION (JU2) settings that can be used to configure the desired mode of operation. Refer to the MAX17634 data sheet for more details on the modes of operation.

**Table 1. Converter EN/UVLO Jumper (JU1) Settings**

SHUNT POSITION	EN/UVLO PIN	MAX17634B EV KIT OUTPUT
1-2	Connected to VIN	Enabled
Not Installed*	Connected to the center node of resistor-divider R1 and R2	Enabled, UVLO level set through the R1 and R2 resistors
2-3	Connected to SGND	Disabled

\*Default position

**Table 2. Mode Selection Jumper (JU2) Settings**

SHUNT POSITION	MODE/SYNC PIN	MAX17634B EV KIT OUTPUT
1-2	Connected to INTVCC	DCM mode of operation
2-3*	Connected to SGND	PWM mode of operation
Not Installed	Unconnected	PFM model of operation

\*Default position

### External Clock Synchronization (SYNC)

The EV kit provides SYNC pin on jumper JU2 to synchronize the MAX17634 to an optional external clock. Leave Jumper (JU2) open when external clock signals are applied. In the presence of a valid external clock for synchronization, the MAX17634 operates in PWM mode only. For more details about external clock synchronization, refer to the MAX17634 data sheet.

### Active-Low, Open-Drain Reset Output ( $\overline{\text{RESET}}$ )

The EV kit provides a  $\overline{\text{RESET}}$  PCB pad to monitor the status of the converter.  $\overline{\text{RESET}}$  goes high when VOUT rises above 95% (typ) of its nominal regulated output voltage.  $\overline{\text{RESET}}$  goes low when VOUT falls below 92% (typ) of its nominal regulated voltage.

### Hot Plug-In and Long Input Cables

The MAX17634BEVKIT# PCB layout provides an optional electrolytic capacitor (C6, 47 $\mu$ F/50V). This capacitor limits the peak voltage at the input of the MAX17634B when the DC input source is “Hot-Plugged” to the EV kit input terminals with long input cables. The equivalent series resistance (ESR) of the electrolytic capacitor dampens the oscillations caused by interaction of the inductance of the long input cables, and the ceramic capacitors at the buck converter input.

**MAX17634BEVKIT# Performance Report**

( $V_{IN} = 24V$ ,  $L = 8.2\mu H$  (XAL6060-822ME),  $f_{SW} = 400kHz$ , unless otherwise noted.)

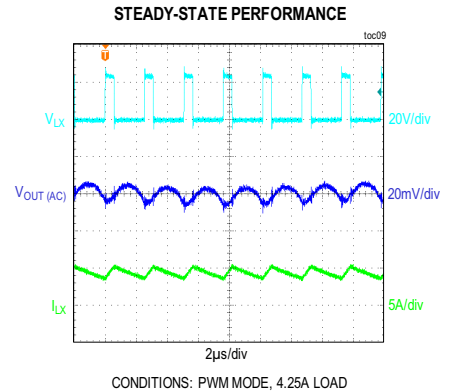
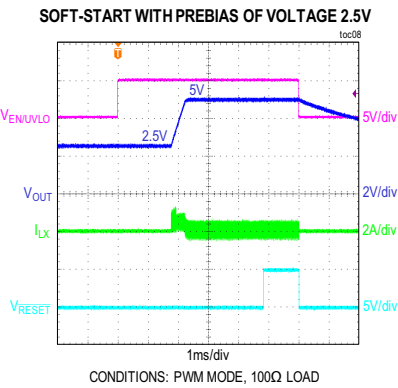
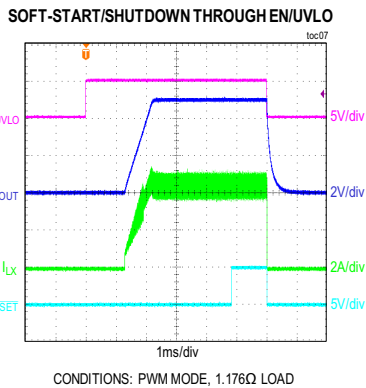
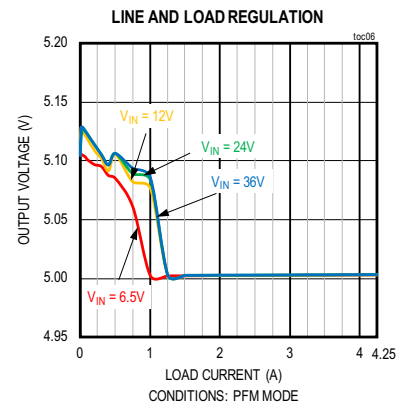
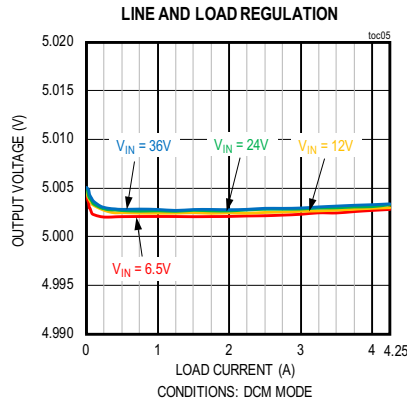
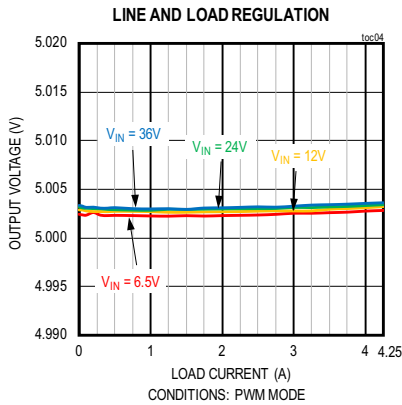
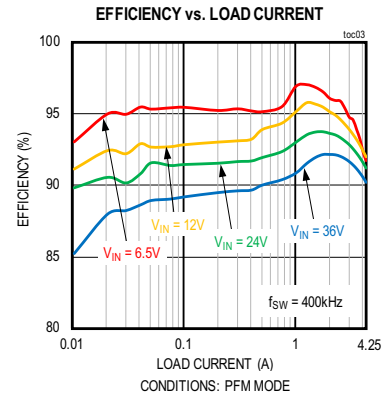
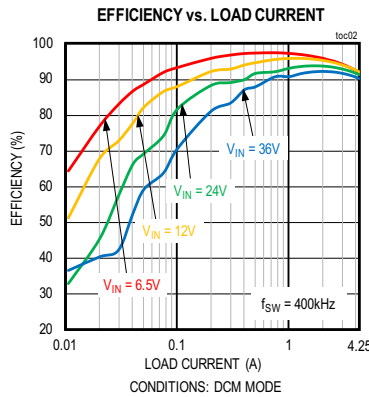
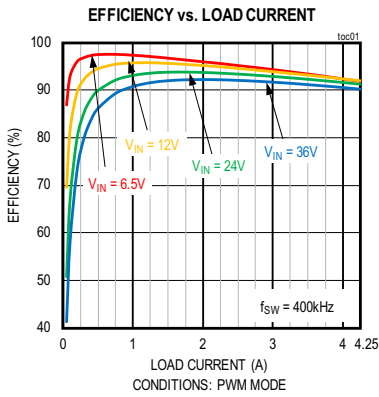

**MAX17634BEVKIT# Performance Report (continued)**

( $V_{IN} = 24V$ ,  $L = 8.2\mu H$  (XAL6060-822ME),  $f_{SW} = 400kHz$ , unless otherwise noted.)

STEADY-STATE PERFORMANCE

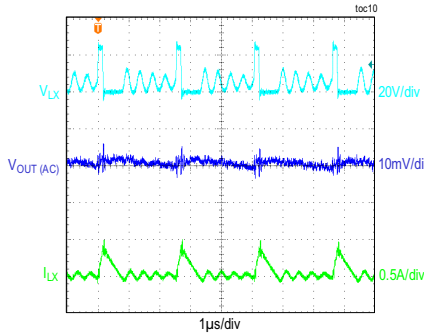

CONDITIONS: DCM MODE, 50mA LOAD

STEADY-STATE PERFORMANCE

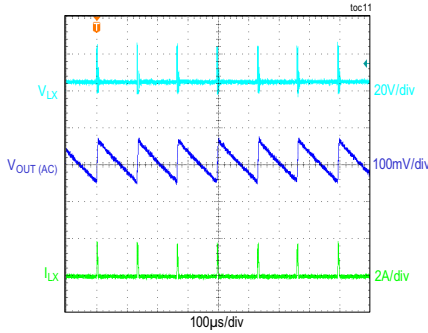

CONDITIONS: PFM MODE, 50mA LOAD

LOAD TRANSIENT BETWEEN 0A AND 2A



CONDITIONS: PWM MODE

LOAD TRANSIENT BETWEEN 2A AND 4A

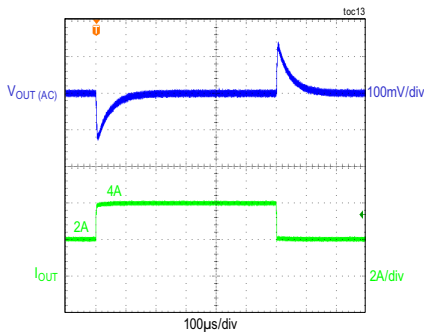

CONDITIONS: PWM/PFM/DCM MODE

LOAD TRANSIENT BETWEEN 0.05A AND 2A

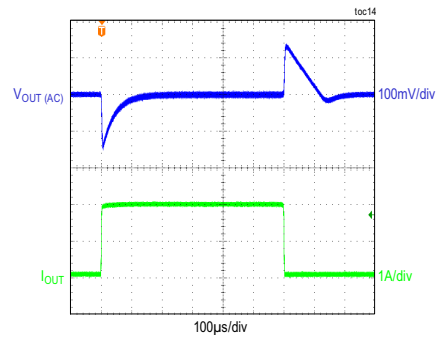

CONDITIONS: DCM MODE

LOAD TRANSIENT BETWEEN 0.05A AND 2A

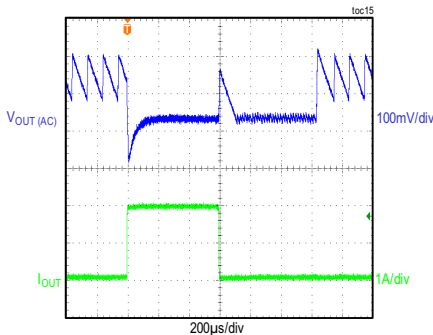

CONDITIONS: PFM MODE

BODE PLOT

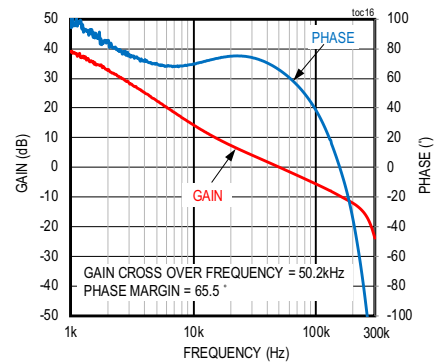

CONDITIONS: PWM MODE, 4.25A LOAD

### Ordering Information

PART	TYPE
MAX17634BEVKIT#	EV Kit

#Denotes RoHS compliant.

### Component Suppliers

SUPPLIER	WEBSITE
Coilcraft, Inc.	<a href="http://www.coilcraft.com">www.coilcraft.com</a>
Murata Americas	<a href="http://www.murata.com">www.murata.com</a>
Panasonic Corp.	<a href="http://www.panasonic.com">www.panasonic.com</a>
TDK Corp.	<a href="http://www.component.tdk.com">www.component.tdk.com</a>
Venkel Ltd.	<a href="http://www.venkel.com">www.venkel.com</a>
SullinsCorp	<a href="http://www.sullinscorp.com">www.sullinscorp.com</a>
Taiyo Yuden	<a href="http://www.t-yuden.com">www.t-yuden.com</a>
Vishay Dale	<a href="http://www.vishay.com">www.vishay.com</a>

**Note:** Indicate that you are using the MAX17634B IC when contacting these component suppliers.

**MAX17634BEVKIT# Bill of Materials**

S.No	DESIGNATOR	DESCRIPTION	QUANTITY	MANUFACTURER PART NUMBER
1	C1, C10	4.7µF, 10%, 50V, X7R, Ceramic capacitor (1206)	2	MURATA GRM31CR71H475KA12
2	C2	2.2µF, 10%, 10V, X7R, Ceramic capacitor (0603)	1	MURATA GRM188R71A225KE15
3	C3	5600pF, 2%, 50V, COG, Ceramic capacitor (0402)	1	MURATA GRM1555C1H562GE01
4	C4, C7	47µF, 20%, 10V, X7R, Ceramic capacitor (1210)	2	MURATA GRM32ER71A476ME15
5	C5	0.1µF, 10%, 16V, X7R, Ceramic capacitor (0402)	1	TAIYO YUDEN EMK105B7104KV
6	C6	47µF, 20%, 50V, Electrolytic capacitor	1	PANASONIC EEE-TG1H470UP
7	C8, C11, C16, C17	150pF, 5%, 100V, X7R, Ceramic capacitor(0402)	4	TDK C1005C0G2A151J050BA
8	C9	0.1µF, 10%, 50V, X7R, Ceramic capacitor (0402)	1	TDK C1005X7R1H104K050BE
9	L1	INDUCTOR, 8.2µH, 20%, 8A (6mm x 6mm)	1	COILCRAFT XAL6060-822ME
10	R1	RESISTOR, 3.32MΩ, 1% (0402)	1	Any
11	R2	RESISTOR, 787kΩ, 1% (0402)	1	Any
12	R3, R7	RESISTOR, 0Ω (0402)	2	Any
13	R5	RESISTOR, 51kΩ, 1% (0402)	1	Any
14	R6	RESISTOR, 10kΩ, 1% (0402)	1	Any
15	U1	HIGH-EFFICIENCY; SYNCHRONOUS STEP-DOWN DC-DC CONVERTER (TQFN20-EP 4mm x 4mm)	1	MAX17634BATP+
16	JU1, JU2	3-pin header	2	SULLINS GRPB031VWVN-RC
17	-	Shunts	2	SULLINS NPB02SVAN-RC
18	C12, C13	OPEN: Capacitor (1206)	0	
19	C14, C19	OPEN: Capacitor (1210)	0	
20	FB1	OPEN: Ferrite Bead (0805)	0	
21	L2	OPEN: Inductor (5mm x 5mm)	0	
22	C15	OPEN: Capacitor (0402)	0	
23	C18	OPEN: Capacitor (0603)	0	
24	R4, R8	OPEN: Resistor (0402)	0	

DEFAULT JUMPER TABLE	
JUMPER	SHUNT POSITION
JU1	2
JU2	2-3

MAX17634BEVKIT# Schematic

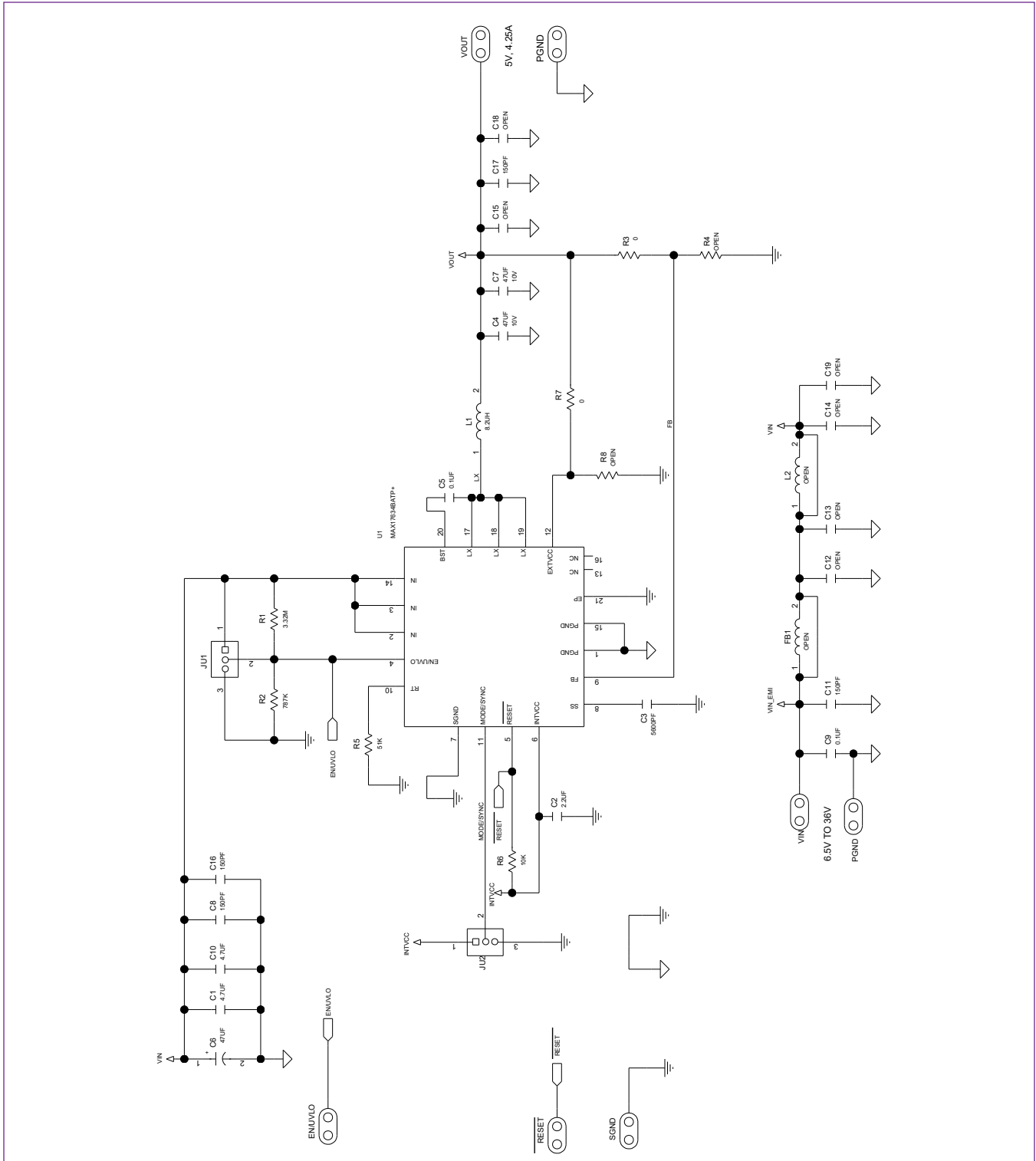



# MAX17634BEVKIT# Evaluation Kit

Evaluates: MAX17634B  
5V Output-Voltage Application

## MAX17634BEVKIT# PCB Layout

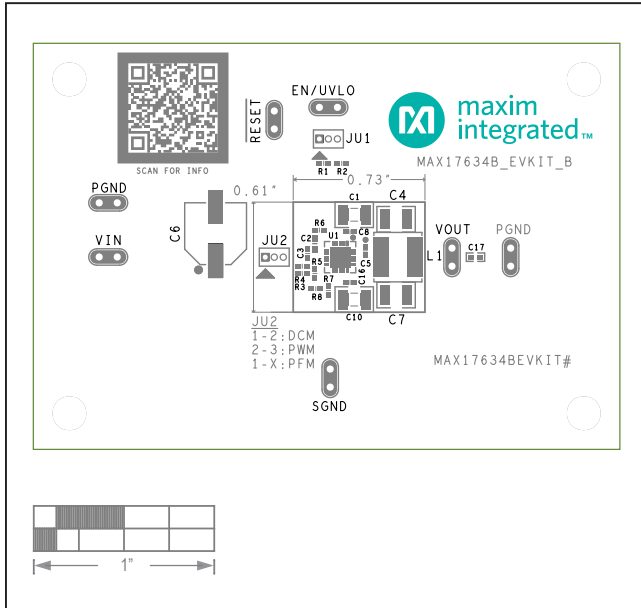

MAX17634B EV Kit—Top Silkscreen

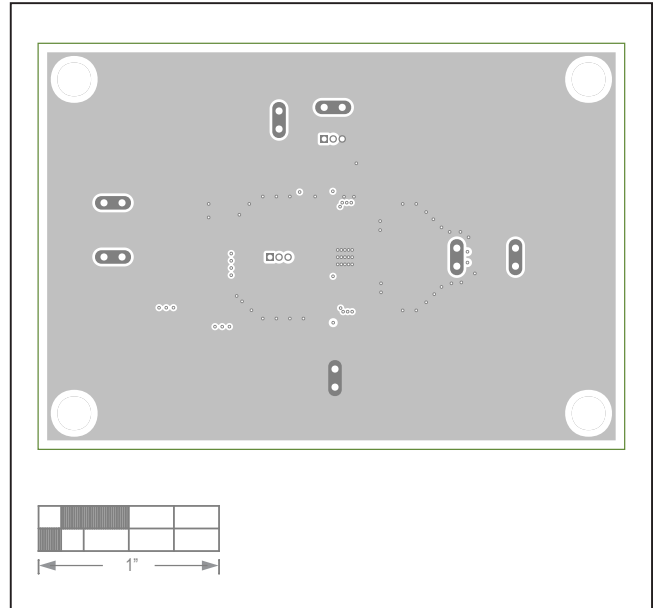

MAX17634B EV Kit—Layer2 GND

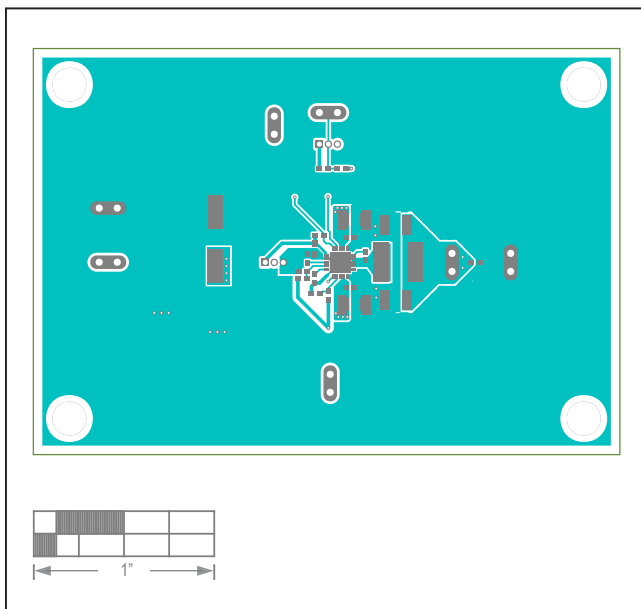

MAX17634B EV Kit—Top

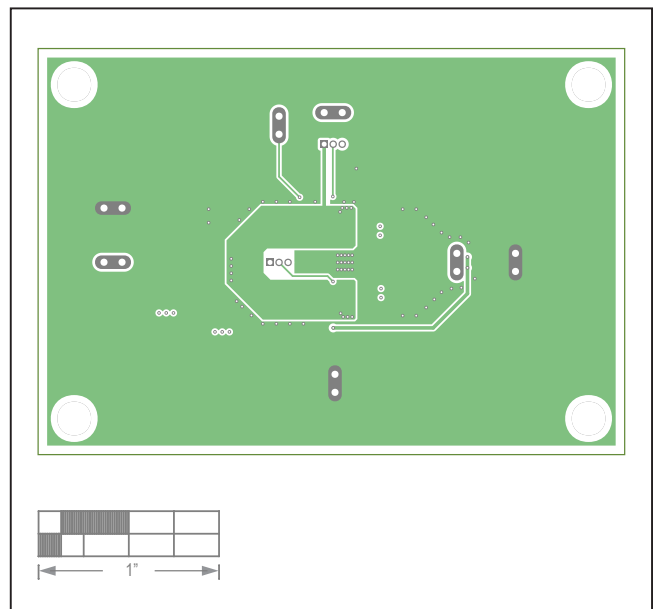

MAX17634B EV Kit—Layer3 GND

MAX17634BEVKIT# PCB Layout (continued)

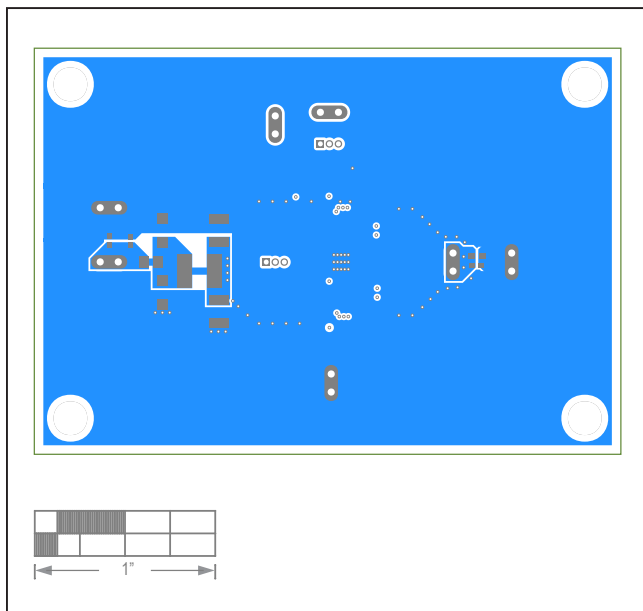

MAX17634B EV Kit—Bottom

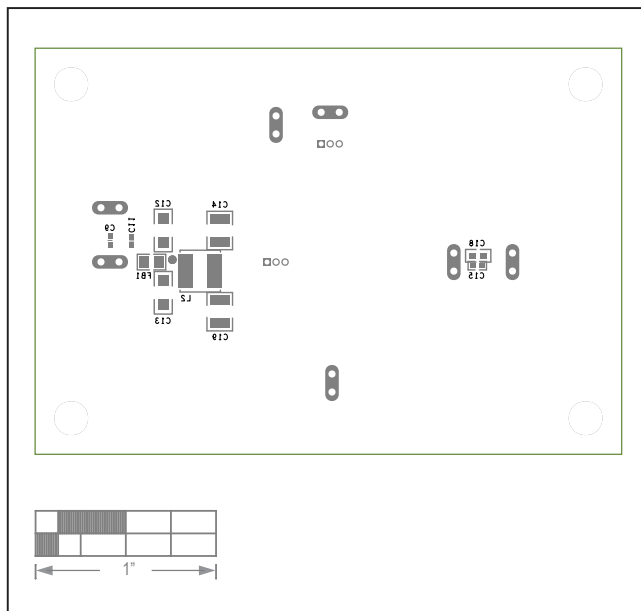

MAX17634B EV Kit—Bottom Silkscreen

## Revision History

REVISION NUMBER	REVISION DATE	DESCRIPTION	PAGES CHANGED
0	8/19	Initial release	—
1	9/19	Updated title of data sheet	1–11

For pricing, delivery, and ordering information, please visit Maxim Integrated's online storefront at <https://www.maximintegrated.com/en/storefront/storefront.html>.

*Maxim Integrated cannot assume responsibility for use of any circuitry other than circuitry entirely embodied in a Maxim Integrated product. No circuit patent licenses are implied. Maxim Integrated reserves the right to change the circuitry and specifications without notice at any time.*

## X-ON Electronics

Largest Supplier of Electrical and Electronic Components

*Click to view similar products for [Power Management IC Development Tools](#) category:*

*Click to view products by [Maxim](#) manufacturer:*

Other Similar products are found below :

[EVB-EP5348UI](#) [MIC23451-AAAYFL EV](#) [MIC5281YMME EV](#) [124352-HMC860LP3E](#) [DA9063-EVAL](#) [ADP122-3.3-EVALZ](#) [ADP130-0.8-EVALZ](#) [ADP130-1.8-EVALZ](#) [ADP1740-1.5-EVALZ](#) [ADP1870-0.3-EVALZ](#) [ADP1874-0.3-EVALZ](#) [ADP199CB-EVALZ](#) [ADP2102-1.25-EVALZ](#) [ADP2102-1.875EVALZ](#) [ADP2102-1.8-EVALZ](#) [ADP2102-2-EVALZ](#) [ADP2102-3-EVALZ](#) [ADP2102-4-EVALZ](#) [AS3606-DB](#) [BQ25010EVM](#) [BQ3055EVM](#) [ISLUSBI2CKIT1Z](#) [LP38512TS-1.8EV](#) [EVAL-ADM1186-1MBZ](#) [EVAL-ADM1186-2MBZ](#) [ADP122UJZ-REDYKIT](#) [ADP166Z-REDYKIT](#) [ADP170-1.8-EVALZ](#) [ADP171-EVALZ](#) [ADP1853-EVALZ](#) [ADP1873-0.3-EVALZ](#) [ADP198CP-EVALZ](#) [ADP2102-1.0-EVALZ](#) [ADP2102-1-EVALZ](#) [ADP2107-1.8-EVALZ](#) [ADP5020CP-EVALZ](#) [CC-ACC-DBMX-51](#) [ATPL230A-EK](#) [MIC23250-S4YMT EV](#) [MIC26603YJL EV](#) [MIC33050-SYHL EV](#) [TPS60100EVM-131](#) [TPS65010EVM-230](#) [TPS71933-28EVM-213](#) [TPS72728YFFEVM-407](#) [TPS79318YEQEVM](#) [UCC28810EVM-002](#) [XILINXPWR-083](#) [LMR22007YMINI-EVM](#) [LP38501ATJ-EV](#)