

MAX20028 Evaluation Kit

Evaluates: MAX20028

General Description

The MAX20028 evaluation kit (EV kit) is a fully assembled and tested surface-mount PCB that contains all the components necessary to evaluate the MAX20028 power-management IC (PMIC). The EV kit includes one high-voltage step-down controller and two low-voltage step-down converters.

The EV kit can operate from 3.5V to 36V input voltages and is optimized for automotive infotainment applications. The high-voltage controller is configured for a 5V output that provides at least 5A. The low-voltage step-down converters are configured for 3.3V and 1.2V, each providing up to 3A. The EV kit can be easily reconfigured to operate in continuous PWM mode, skip mode, or external synchronization operation.

The EV kit comes with MAX20028ATJA/VY+ device installed, but is capable of evaluating other variants of the MAX20028 IC. Refer to the MAX20028 IC data sheet for external component selection.

Features

- 3.5V to 36V Input Range
- 20 μ A Quiescent Current with DC-DC Controller Enabled
- Output Voltages
 - 5V Output at 5A (High-Voltage, Step-Down Controller, Buck 1)
 - 3.3V Output at 3A (Step-Down Converter, Buck 2)
 - 1.2V Output at 3A (Step-Down Converter, Buck 3)
- High-Frequency Operation
 - 2.1MHz or Optional Divide-Down Operation for Buck 1
- Individual Enable Inputs and Reset Outputs
- Proven PCB Layout
- Fully Assembled and Tested

[Ordering Information](#) appears at end of data sheet.

Quick Start

Recommended Equipment

- MAX20028 EV kit
- 3.5V to 36V, 4A DC power supply
- Voltmeter

Procedure

The EV kit is fully assembled and tested. Follow the steps below to verify board operation. **Caution: Do not turn on the power supply until all connections are completed.**

- 1) Verify that a shunt is installed across pins 1-2 on jumpers JU1–JU3 and JU5–JU7.
- 2) Verify that a shunt is installed across pins 2-3 on jumper JU4.
- 3) Connect the positive terminal of the power supply to the VBAT PCB pad. Connect the negative terminal of the power supply to the PGND PCB pads closest to VBAT.
- 4) Set the power-supply VIN to 14V.
- 5) Turn on the power supply and verify that the Buck 1 output (VOUT1) is 5V.
- 6) Verify that the Buck 2 output (VOUT2) is 3.3V.
- 7) Verify that the Buck 3 output (VOUT3) is 1.2V.

Detailed Description of Hardware

The MAX20028 EV kit comes fully assembled and tested with all the components necessary to evaluate the MAX20028 step-down controller with dual 2.1MHz step-down DC-DC converters. The EV kit comes with a MAX20028ATJA/VY+ 32-pin side-wettable TQFN-EP device installed. However, other MAX20028 variants can be evaluated on the same EV kit with some simple modifications. Refer to the MAX20028 IC data sheet for additional information regarding component selection when altering the EV kit.

High-Voltage Controller, Buck 1

Buck 1 is a high-voltage, step-down controller designed to operate with a 3.5V to 36V input voltage range. Buck 1 is configured for a 5V output and up to 5A load current. To change the Buck 1 output voltage to a fixed 3.3V, remove R7 and populate R6 with a 0Ω resistor.

The Buck 1 switching frequency can be configured for 2.1MHz or the factory-trimmed divide-down frequency of

420kHz. By default, Buck 1 is configured to operate at 2.1MHz. To change the Buck 1 switching frequency to 420kHz, remove R22 and populate R21 with a 0Ω resistor. The switching frequencies of Buck 2 and Buck 3 are not affected by the CSEL1 input. For additional information, refer to the *Buck 1 Clock Select (CSEL1)* section in the MAX20028 IC data sheet.

Low-Voltage Converters, Buck 2 and Buck 3

Buck 2 and Buck 3 are low-voltage, synchronous step-down converters designed to operate directly from the Buck 1 output. Buck 2 is configured for a 3.3V output and Buck 3 is configured for a 1.2V output. Both Buck 2 and Buck 3 have a maximum output current of 3A. The output voltages are configurable between 0.8V and 3.6V by resistor-dividers. Refer to the *OUT2/OUT3 Adjustable Output-Voltage Option* section in the MAX20028 IC data sheet for additional information.

Spread-Spectrum Operation (JU4)

The EV kit features a pin-selectable spread-spectrum mode of operation. Jumper JU4 enables or disables spread-spectrum operation (see Table 1).

Synchronization Input (JU5)

The EV kit's SYNC input allows synchronization to an external clock. When synchronizing the device to an external clock, leave jumper JU5 unconnected. For fixed-frequency PWM mode operation, connect a shunt across pins 1-2 on JU5. For skip mode operation, connect a shunt across pins 2-3 on JU5.

Reset Outputs

The EV kit features individual $\overline{\text{RESET}}$ outputs for each buck that assert low when the buck output drops 6% below the regulated voltage. $\overline{\text{RESET}}$ remains low for a fixed timeout period of 3.9ms after the buck output rises up to its regulated voltage. $\overline{\text{RESET1}}$ has a pullup resistor, making it a logic-level output. $\overline{\text{RESET2}}$ and $\overline{\text{RESET3}}$ are either logic-level or open-drain outputs, depending on jumpers JU6 and JU7 (see Table 1).

Thermal Warning

The EV kit features a thermal-warning indicator output. The $\overline{\text{ERR}}$ output asserts low when the junction temperature on the IC exceeds +145°C (typ). The thermal-warning indicator has a typical hysteresis of 15°C.

Table 1. Jumper Descriptions (JU1–JU7)

JUMPER	SHUNT POSITION	DESCRIPTION
JU1	1-2*	Connects EN1 to VBAT through a pullup resistor (normal operation).
	2-3	Connects EN1 to PGND (shutdown).
JU2	1-2*	Connects EN2 to BIAS (Buck 2 enabled).
	2-3	Connects EN2 to PGND (Buck 2 disabled).
JU3	1-2*	Connects EN3 to BIAS (Buck 3 enabled).
	2-3	Connects EN3 to PGND (Buck 3 disabled).
JU4	1-2	Connects SSEN to BIAS, enabling spread-spectrum operation.
	2-3*	Connects SSEN to PGND, disabling spread-spectrum operation.
JU5	1-2*	Connects SYNC to BIAS to enable continuous PWM mode.
	2-3	Connects SYNC to PGND to enable skip mode under light-load conditions.
	Open	When SYNC is unconnected, or when a clock source is present, continuous PWM mode is enabled. SYNC can be used to synchronize with other supplies when a clock source is present.
JU6	Closed*	Connects $\overline{\text{RESET2}}$ to VOUT1 through a pullup resistor, making the $\overline{\text{RESET2}}$ output a logic level signal.
	Open	Disconnects $\overline{\text{RESET2}}$ from VOUT1, leaving $\overline{\text{RESET2}}$ as an open-drain output.
JU7	Closed*	Connects $\overline{\text{RESET3}}$ to VOUT1 through a pullup resistor, making $\overline{\text{RESET3}}$ output a logic level signal.
	Open	Disconnects $\overline{\text{RESET3}}$ from VOUT1, leaving $\overline{\text{RESET3}}$ as an open-drain output.

*Default position.

Component Suppliers

SUPPLIER	PHONE	WEBSITE
AVX Corp.	864-967-2150	www.avx.com
Coilcraft Inc.	847-639-6400	www.coilcraft.com
Diodes Incorporated	805-446-4800	www.diodes.com
Fairchild Semiconductor	888-522-5372	www.fairchildsemi.com
Murata Electronics North America, Inc.	770-436-1300	www.murata-northamerica.com
NXP Semiconductors	408-474-8142	www.nxp.com
Panasonic Corp.	800-344-2112	www.panasonic.com
TDK Corp.	847-803-6100	www.component.tdk.com
Vishay Dale	402-563-6866	www.vishay.com

Note: Indicate that you are using the MAX20028 when contacting these component suppliers.

Ordering Information

PART	TYPE
MAX20028EVKIT#	EV Kit

#Denotes RoHS compliant.

MAX20028 EV Kit Bill of Materials

DESIGNATION	QTY	DESCRIPTION
C1	1	2.2uF 10%, 50V X7R ceramic capacitor (0805), TDK C2012X7R1H225K
C2	1	1uF 10%, 50V X7R ceramic capacitor (0805), TDK C2012X7R1H105K
C3, C4, C6, C7, C16	5	0.1uF 10%, 50V X7R ceramic capacitor (0603), MURATA GCM188R71H104K
C5	1	220uF 20%, 50V aluminum electrolytic capacitor (Case size H13), Panasonic EEV-TG1H221Q
C9-C12	4	47uF 20%, 10V X7R ceramic capacitor (1210), Murata GRM32ER71A476K
C13	0	Not installed, ceramic capacitor (0402)
C14	1	120pF 10% 50V ceramic capacitor (0402), AVX 04025C121KAT2A
C15	1	1.5nF 10% 50V ceramic capacitor (0402), TDK C1005X7R1H152K
C17	1	1uF 10%, 16V X7R ceramic capacitor (0603), MURATA GCM188R71C105K
C18, C22	2	10uF 10%, 6.3V X7R ceramic capacitor (0805), MURATA GCM21BR70J106K
C19, C20, C23, C24	4	47uF 10%, 6.3V X7R ceramic capacitor (1210), MURATA GRM32ER70J476KE20L
C21	1	20pF 50V C0G ceramic capacitor (0402), MURATA GRM1555C1H200J
C25	1	10pF 50V C0G ceramic capacitor (0402), MURATA GRM1555C1H100J
C27	1	4.7uF 10%, 50V X7R ceramic capacitor (1210), MURATA GCM32ER71H475K
D1	1	switching diode SOD-323, Diodes inc. 1N4148WS
D2	1	5A low VF MEGA Schottky barrier rectifier, NXP PMEG3050EP
FB1	1	Ferrite Bead, 60 ohm, 600mA, Murata BLM41PG600SH1
FB2, FB3	2	Not installed, ferrite beads, short (PCB trace)
JU1-JU5	5	3 pin header, 2.54MM,
JU6, JU7	2	2 pin header, 2.54MM,
L1	1	1.2uH, 12.5A inductor, Coilcraft XAL5030-122ME
L2	1	1.0uH, 8.7A inductor, Coilcraft XAL4020-102ME
L3	1	0.6uH, 10.4A inductor, Coilcraft XAL4020-601ME
N1, N2	2	40V, 18A, 26m ohm N-Channel Power Trench MOSFET, Fairchild FDMC8015L
R1-R4, R7, R20, R22	7	0 ohm, +/-5% resistors (0402)
R5, R6, R21	0	Not installed, resistors (0402)
R8	1	22k ohm 1% (0402), Panasonic ERJ-2RKF2202X
R9-R11, R13	4	5.1k ohm, 5% tolerance (0402)
R12, R14	2	100k ohm, 5% tolerance (0603)
R15	1	10 ohm, 1% tolerance (0402)
R16	1	10k ohm, 1% tolerance (0402)
R17	1	20k ohm, 1% tolerance (0402)
R18	1	75k ohm, 1% tolerance (0402)
R19	1	24k ohm, 1% tolerance (0402)
RCS	1	15m ohm, 1W, 1% (1206), Vishay Dale WSL1206R0150FEA
TP1-TP3	3	PCB Miniature test points
U1	1	Step-Down Controller with Dual 2.1MHz Step-Down DC-DC Converters (32 TQFN-EP), MAX20028ATJA/VY+
-	7	Shunts
-	1	PCB: MAX20028 EVKIT

MAX20028 EV Kit Schematic

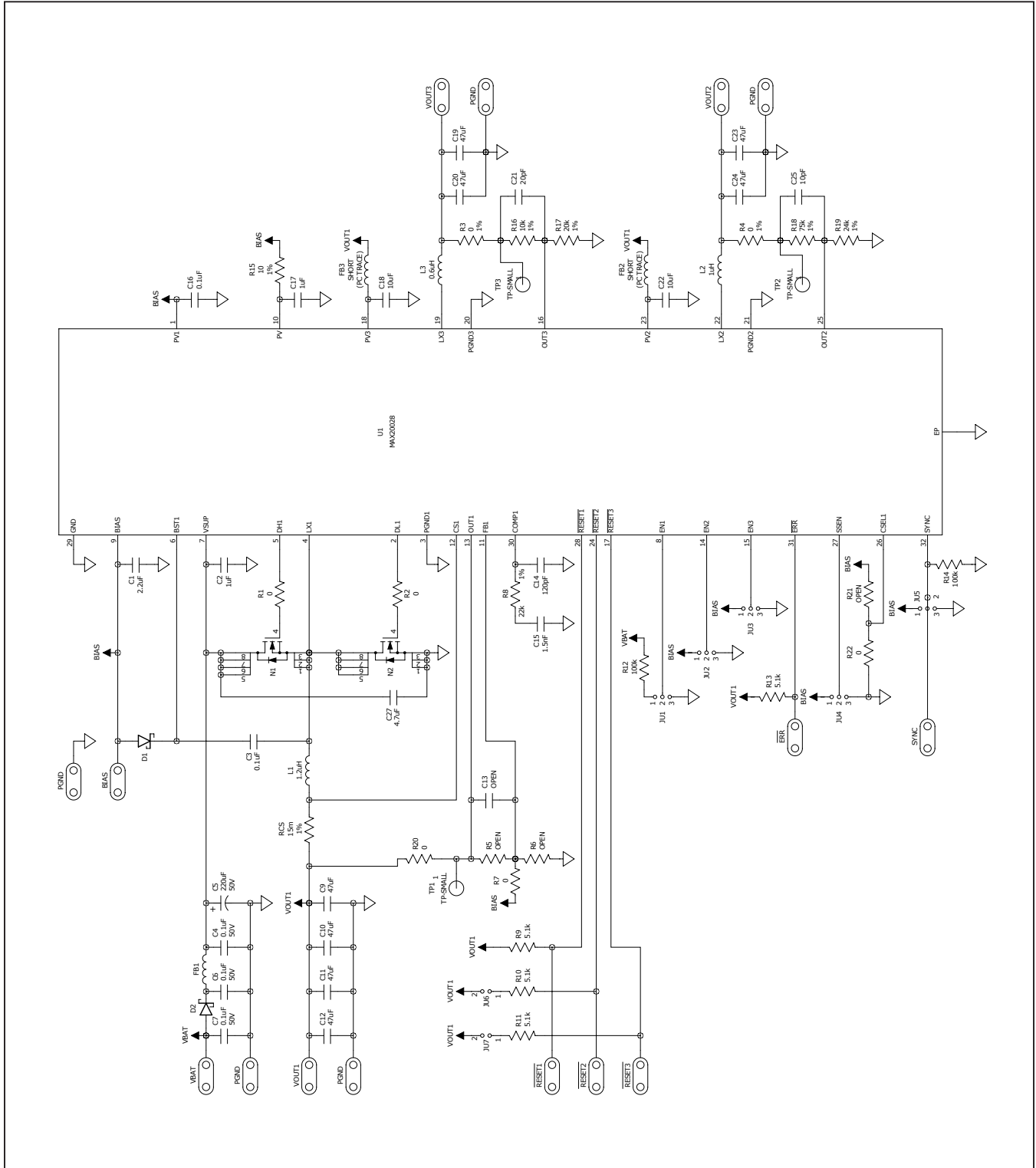

MAX20028 EV Kit PCB Layout

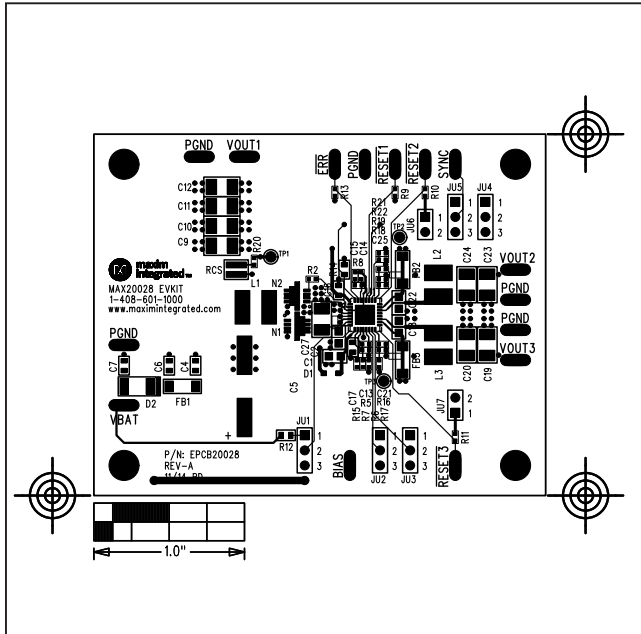

MAX20028 EV Kit Component Placement Guide—Component Side

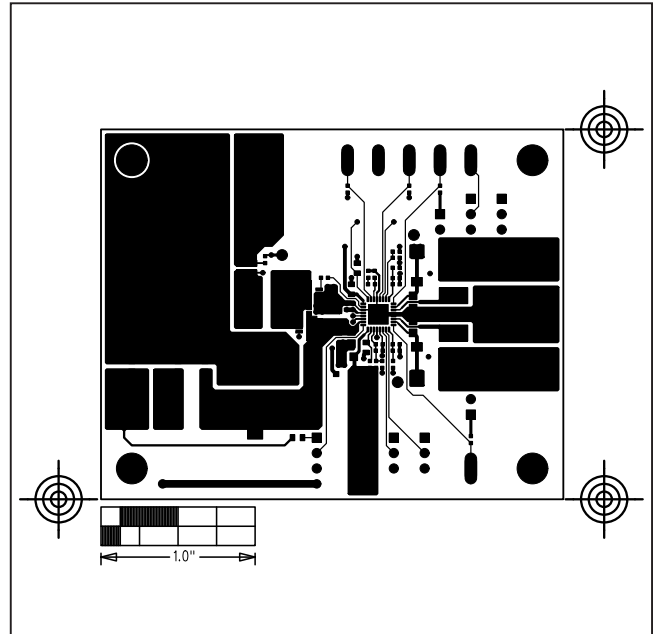

MAX20028 EV Kit PCB Layout—Component Side

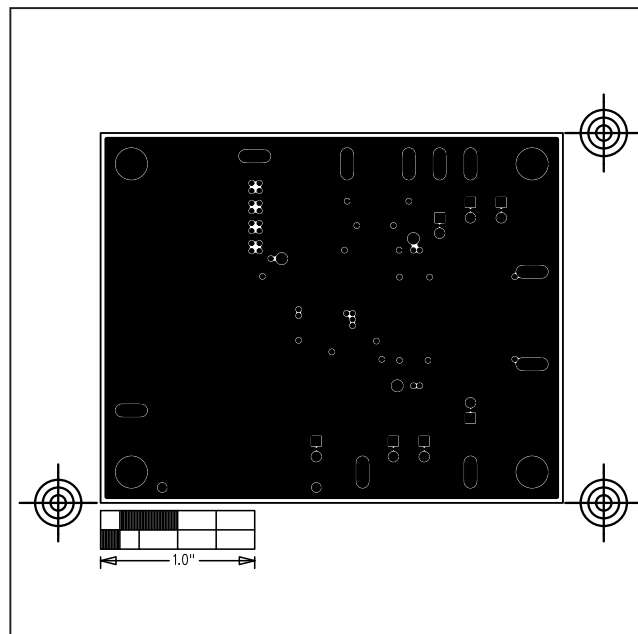

MAX20028 EV Kit PCB Layout—Layer 2

MAX20028 EV Kit PCB Layout (continued)

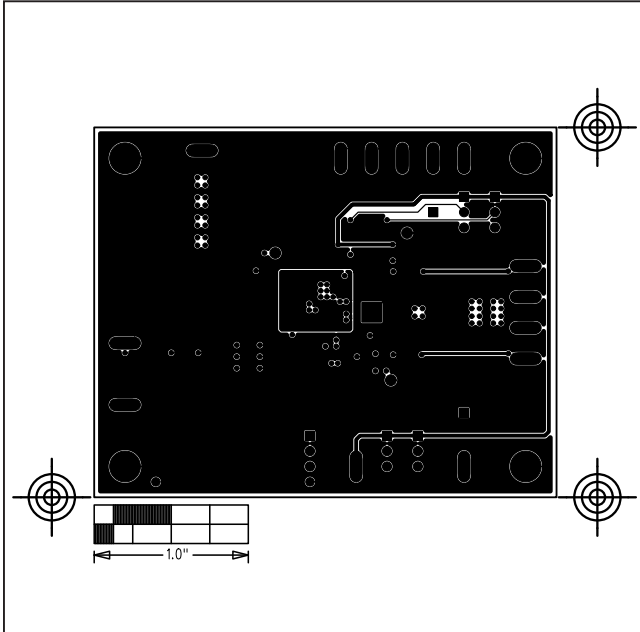

MAX20028 EV Kit PCB Layout—Layer 3

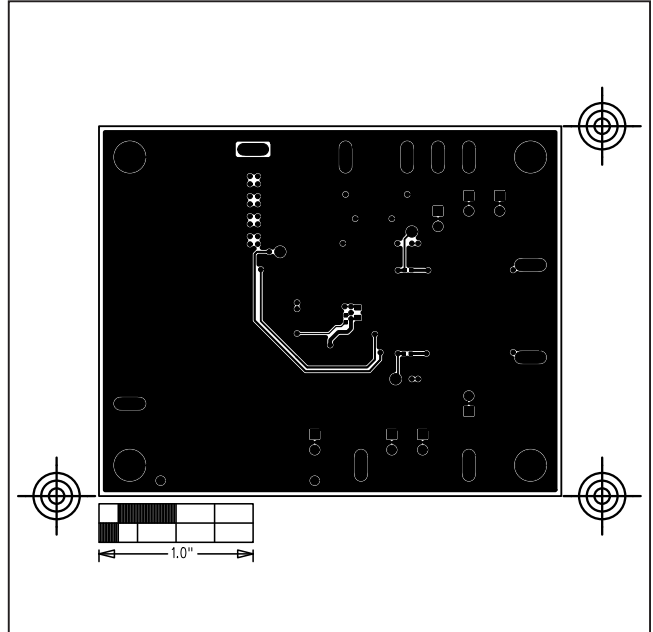

MAX20028 EV Kit PCB Layout—Solder Side

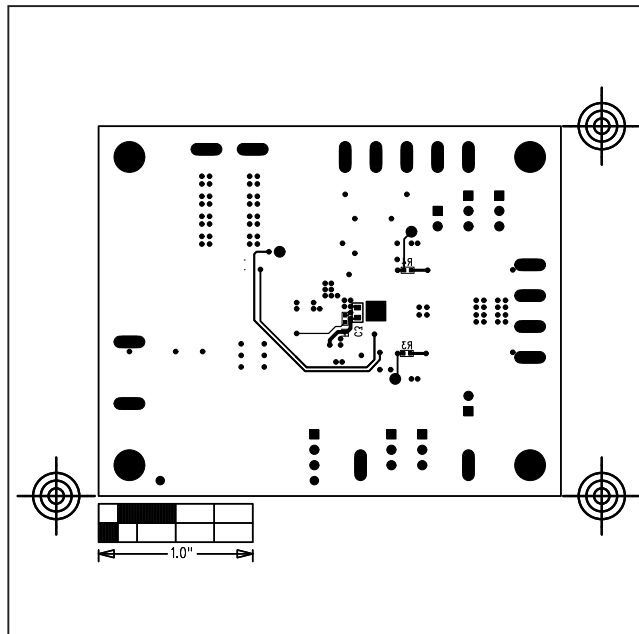

MAX20028 EV Kit Component Placement Guide—Solder Side

Revision History

REVISION NUMBER	REVISION DATE	DESCRIPTION	PAGES CHANGED
0	7/18	Initial release	—
1	2/19	Updated part number MAX20028AGJA/VY+ to MAX20028ATJA/VY+ in <i>General Description, Detailed Description of Hardware, and EV Kit Bill of Materials</i>	1, 2, 4

For pricing, delivery, and ordering information, please visit Maxim Integrated's online storefront at <https://www.maximintegrated.com/en/storefront/storefront.html>.

Maxim Integrated cannot assume responsibility for use of any circuitry other than circuitry entirely embodied in a Maxim Integrated product. No circuit patent licenses are implied. Maxim Integrated reserves the right to change the circuitry and specifications without notice at any time.

X-ON Electronics

Largest Supplier of Electrical and Electronic Components

Click to view similar products for [Power Management IC Development Tools](#) category:

Click to view products by [Maxim](#) manufacturer:

Other Similar products are found below :

[EVB-EP5348UI](#) [MIC23451-AAAYFL EV](#) [MIC5281YMME EV](#) [124352-HMC860LP3E](#) [DA9063-EVAL](#) [ADP122-3.3-EVALZ](#) [ADP130-0.8-EVALZ](#) [ADP130-1.8-EVALZ](#) [ADP1740-1.5-EVALZ](#) [ADP1870-0.3-EVALZ](#) [ADP1874-0.3-EVALZ](#) [ADP199CB-EVALZ](#) [ADP2102-1.25-EVALZ](#) [ADP2102-1.875EVALZ](#) [ADP2102-1.8-EVALZ](#) [ADP2102-2-EVALZ](#) [ADP2102-3-EVALZ](#) [ADP2102-4-EVALZ](#) [AS3606-DB](#) [BQ25010EVM](#) [BQ3055EVM](#) [ISLUSBI2CKIT1Z](#) [LP38512TS-1.8EV](#) [EVAL-ADM1186-1MBZ](#) [EVAL-ADM1186-2MBZ](#) [ADP122UJZ-REDYKIT](#) [ADP166Z-REDYKIT](#) [ADP170-1.8-EVALZ](#) [ADP171-EVALZ](#) [ADP1853-EVALZ](#) [ADP1873-0.3-EVALZ](#) [ADP198CP-EVALZ](#) [ADP2102-1.0-EVALZ](#) [ADP2102-1-EVALZ](#) [ADP2107-1.8-EVALZ](#) [ADP5020CP-EVALZ](#) [CC-ACC-DBMX-51](#) [ATPL230A-EK](#) [MIC23250-S4YMT EV](#) [MIC26603YJL EV](#) [MIC33050-SYHL EV](#) [TPS60100EVM-131](#) [TPS65010EVM-230](#) [TPS71933-28EVM-213](#) [TPS72728YFFEVM-407](#) [TPS79318YEQEVM](#) [UCC28810EVM-002](#) [XILINXPWR-083](#) [LMR22007YMINI-EVM](#) [LP38501ATJ-EV](#)