

## General Description

The MAX20330 evaluation kit (EV kit) is a fully assembled and tested circuit board that demonstrates the MAX20330 programmable OVLO with VBUS short detection device. The EV kit comes with the MAX20330EWA+ installed.

## Features

- OVP or ID Detection
- Proven PCB Layout
- Fully Assembled and Tested

## EV Kit Contents

- EV Kit Board Containing a MAX20330

## Quick Start

### Required Equipment

- MAX20330 EV kit
- Power supply
- Multimeter

### Procedure

The EV kit is fully assembled and tested. Follow the steps below to verify board operation:

- 1) Connect a 3V power supply to VBUS TP1. Check the voltage on OUT. Verify OUT is also 3V.
- 2) Slowly increase VBUS voltage. Verify OUT voltage follows VBUS. When VBUS reaches ~6.8V, OUT voltage goes down.
- 3) Decrease VBUS voltage and OUT voltage comes back to be same as VBUS voltage.

[Ordering Information](#) appears at end of data sheet.

### Detailed Description

The MAX20330 EV kit is a fully assembled and tested circuit board demonstrating the MAX20330 OVP/ID detector in an 8-bump wafer-level package (WLP).

### VCC Power Supply

The V<sub>CC</sub> can be connected from different power supply sources or externally supplied from TP7.

### I<sup>2</sup>C Communication

Use JU2, JU3, JU4, JU5, and JU6 to have I<sup>2</sup>C pins pulled up to selected supply. User needs to provide I<sup>2</sup>C master to communicate with the device. The slave address is 0010 111.

**Table 1. V<sub>CC</sub> Jumper Setting**

JUMPER	SHUNT POSITION	DESCRIPTION
JU1	1-2*	VCC is connected to VMC
	2-3	VCC is connected to 5VMC

\*Default Position

**Table 2. I<sup>2</sup>C Jumper Setting**

JUMPER	SHUNT POSITION	DESCRIPTION
JU2	Installed	VIO is connected to VCC
	Not installed*	VIO is not connected to VCC
JU3	Installed	SCL is pulled up to VIO
	Not installed*	SCL is not pulled up to VIO
JU4	Installed	SDA is pulled up to VIO
	Not installed*	SDA is not pulled up to VIO
JU5	Installed	INTB is pulled up to VIO
	Not installed*	INTB is not pulled up to VIO
JU6	Installed	VIO is connected to VMC
	Not installed*	VIO is not connected to VMC

\*Default Position

### Ordering Information

PART	TYPE
MAX20330EVKIT#	EV Kit

#Denotes RoHS compliant.

MAX20330 EV Kit Bill of Materials

ITEM	REF_DES	DNI/DNP	QTY	MFG PART #	MANUFACTURER	VALUE	DESCRIPTION	COMMENTS
1	C1	-	1	C1210C105KSRAC	KEMET	1UF	CAPACITOR; SMT; 1210; CERAMIC; 1uF; 50V; 10%; X7R; -55degC to + 125degC;	
2	C2	-	1	C0603Y102K5RACAUTO	KEMET	1000PF	CAP; SMT (0603); 1000PF; 10%; 50V; X7R; CERAMIC CHIP	
3	C3	-	1	GCM188R71H104KA12; GCM188R71H104K; CGA3E2X7R1H104K080AA	MURATA;MURATA;TDK	0.1UF	CAPACITOR; SMT (0603); CERAMIC CHIP; 0.1UF; 50V; TOL=10%; TG=-55 DEGC TO +125 DEGC; TC=X7R; AUTO	
4	C4	-	1	C3216X7R1E475K160AC	TDK	4.7UF	CAPACITOR; SMT (1206); CERAMIC CHIP; 4.7UF; 25V; TOL=10%; MODEL=C SERIES; TG=-55 DEGC TO +125 DEGC; TC=X7R	
5	D1	-	1	PTVS20VS1UR	NEXPERIA	20V	DIODE; TVS; SMT (SOD-123W); VRM=20V; IPP=12.3A	
6	J1	-	1	ZX62-B-5PA(33)	HIROSE ELECTRIC CO LTD.	ZX62-B-5PA(33)	CONNECTOR; MALE; SMT; USB MICRO B-TYPE; BOTTOM MOUNT; RIGHT ANGLE; 5PINS; WITH OPTION TO CONNECT SHIELD PINS	
7	J2	-	1	SBH11-PBPC-D20-ST-BK	SULLINS ELECTRONICS CORP.	SBH11-PBPC-D20-ST-BK	CONNECTOR; MALE; THROUGH HOLE; HEADER CONNECTOR; STRAIGHT; 40PINS; EDGE FOOTPRINT	
8	JU1	-	1	PBC03SAAN	SULLINS	PBC03SAAN	CONNECTOR; MALE; THROUGH HOLE; BREAKAWAY; STRAIGHT; 3PINS; -65 DEGC TO +125 DEGC	
9	JU2-JU6	-	5	PBC02SAAN	SULLINS ELECTRONICS CORP.	PBC02SAAN	EVKIT PART-CONNECTOR; MALE; THROUGH HOLE; BREAKAWAY; STRAIGHT; 2PINS; -65 DEGC TO +125 DEGC;	
10	LED1, LED2	-	2	SML-LX1206GW-TR	LUMEX OPTOCOMPONENTS INC	SML-LX1206GW-TR	DIODE; LED; STANDARD; GREEN; SMT (1206); PIV=2.2V; IF=0.02A; -40 DEGC TO +85 DEGC	
11	Q1	-	1	SISA72DN-T1-GE3	VISHAY SILICONIX	SISA72DN-T1-GE3	TRAN; NCH; POWERPAK1212-8; PD-(3.7W); I-(60A); V-(40V)	
12	R1, R2	-	2	ANY	ANY		RESISTOR; 0805; 0 OHM; JUMPER; 0.125W; THICK FILM; FORMFACTOR	
13	R3, R7	-	2	CRCW08051K00FK;ERJ-6ENF1001V; MCR10EZHF1001;RC0805FR-071KL	VISHAY DALE;PANASONIC; ROHM;YAGEO	1K	RESISTOR; 0805; 1K; 1%; 100PPM; 0.125W; THICK FILM	
14	R4-R6	-	3	CRCW08053K92FK; MCR10EZHF3921	VISHAY DALE;ROHM	3.92K	RESISTOR; 0805; 3.92K OHM; 1%; 100PPM; 0.125W; THICK FILM	
15	SU1-SU6	-	6	STC02SYAN	SULLINS ELECTRONICS CORP.	STC02SYAN	TEST POINT; JUMPER; STR; TOTAL LENGTH=0.256IN; BLACK; INSULATION=PBT CONTACT=PHOSPHOR BRONZE; COPPER PLATED TIN OVERALL	
16	TB1, TB2	-	2	282836-2	TE CONNECTIVITY	282836-2	CONNECTOR; FEMALE; THROUGH HOLE; TERMINAL BLOCK; SIDE WIRE ENTRY; STACKING WITH INTERLOCK STRAIGHT; 2PINS ;	
17	TP1, TP5, TP7, TP15, TP16	-	5	5010	KEYSTONE	N/A	TESTPOINT WITH 1.80MM HOLE DIA, RED, MULTIPURPOSE;	
18	TP2, TP4, TP8, TP10, TP14	-	5	5011	KEYSTONE	N/A	TEST POINT; PIN DIA=0.125IN; TOTAL LENGTH=0.445IN; BOARD HOLE=0.063IN; BLACK; PHOSPHOR BRONZE WIRE SILVER PLATE FINISH;	
19	TP3	-	1	5119	KEYSTONE	N/A	TEST POINT; PIN DIA=0.1IN; TOTAL LENGTH=0.3IN; BOARD HOLE=0.04IN; PURPLE; PHOSPHOR BRONZE WIRE SILVER PLATE FINISH;	
20	TP6	-	1	5004	KEYSTONE	N/A	TEST POINT; PIN DIA=0.1IN; TOTAL LENGTH=0.3IN; BOARD HOLE=0.04IN; YELLOW; PHOSPHOR BRONZE WIRE SILVER PLATE FINISH;	
21	TP9	-	1	5000	KEYSTONE	N/A	TEST POINT; PIN DIA=0.1IN; TOTAL LENGTH=0.3IN; BOARD HOLE=0.04IN; RED; PHOSPHOR BRONZE WIRE SILVER PLATE FINISH;	
22	TP11	-	1	5116	KEYSTONE	N/A	TEST POINT; PIN DIA=0.1IN; TOTAL LENGTH=0.3IN; BOARD HOLE=0.04IN; GREEN; PHOSPHOR BRONZE WIRE SILVER PLATE FINISH;	
23	TP12	-	1	5117	KEYSTONE	N/A	TEST POINT; PIN DIA=0.1IN; TOTAL LENGTH=0.3IN; BOARD HOLE=0.04IN; BLUE; PHOSPHOR BRONZE WIRE SILVER PLATE FINISH;	
24	TP13	-	1	5003	KEYSTONE	N/A	TEST POINT; PIN DIA=0.1IN; TOTAL LENGTH=0.3IN; BOARD HOLE=0.04IN; ORANGE; PHOSPHOR BRONZE WIRE SILVER PLATE FINISH;	
25	U1	-	1	MAX20330EWA+	MAXIM	MAX20330EWA+	EVKIT PART - IC; DET; PROGRAMMABLE OVP CONTROLLER WITH VBUS SHORT DETECTION; MAX20330; PACKAGE OUTLINE: 21-100229; PACKAGE CODE: W81B1+1; WLP8	
26	PCB	-	1	MAX20330	MAXIM	PCB	PCB:MAX20330	
27	Q2	DNP	0	SISA72DN-T1-GE3	VISHAY SILICONIX	SISA72DN-T1-GE3	TRAN; NCH; POWERPAK1212-8; PD-(3.7W); I-(60A); V-(40V)	DNI
TOTAL			49					

MAX20330 EV Kit Schematic

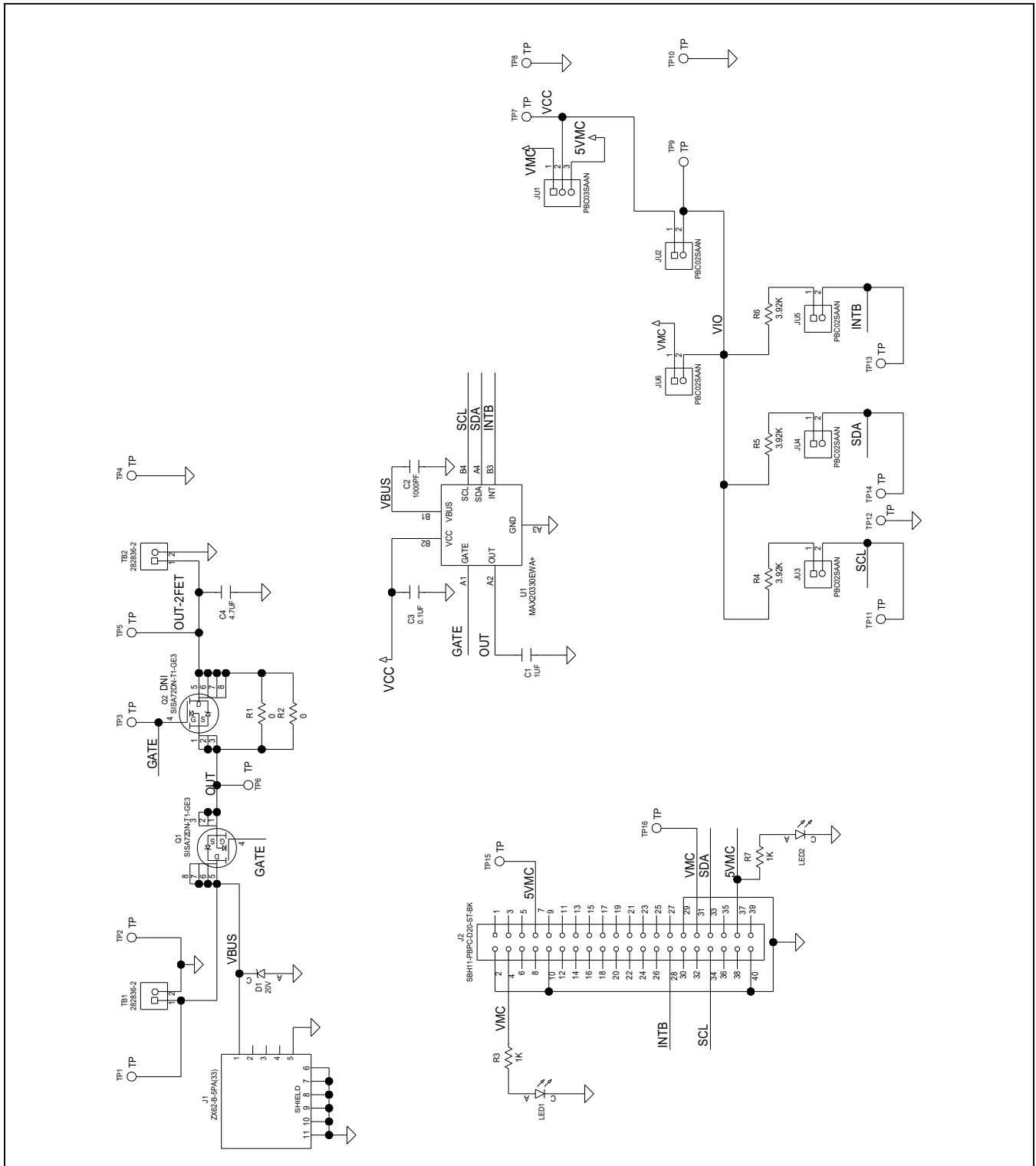

MAX20330 EV PCB Layout Diagrams

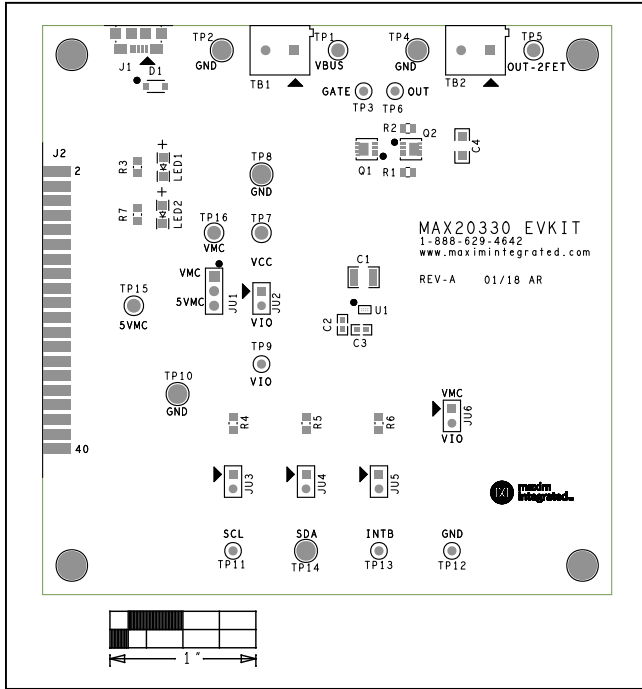

MAX20330 EV Kit—Top Silkscreen

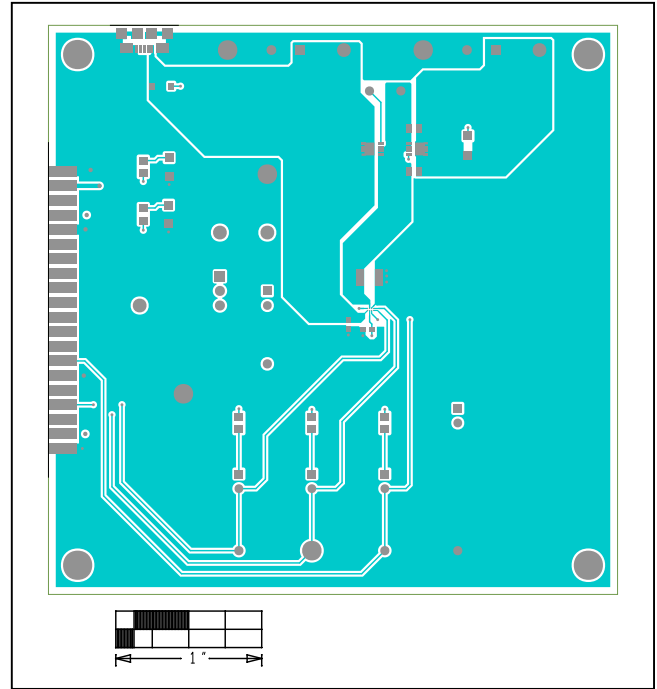

MAX20330 EV Kit—Top

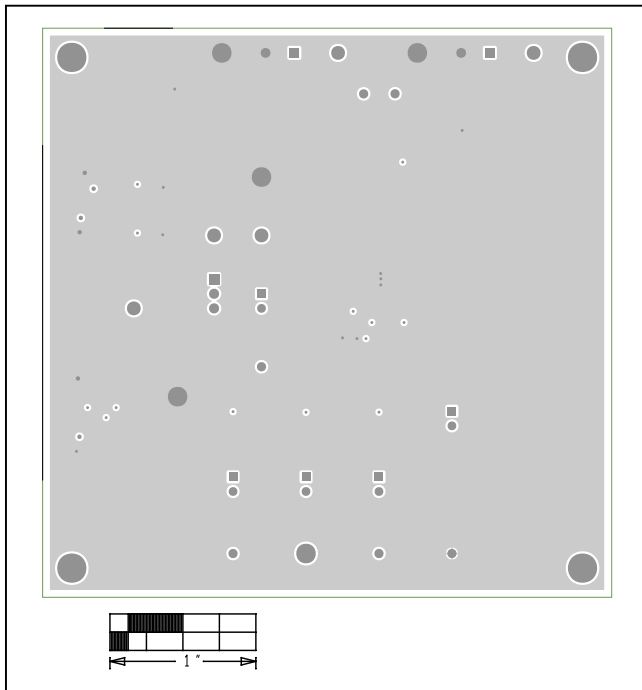

MAX20330 EV Kit—Internal 2

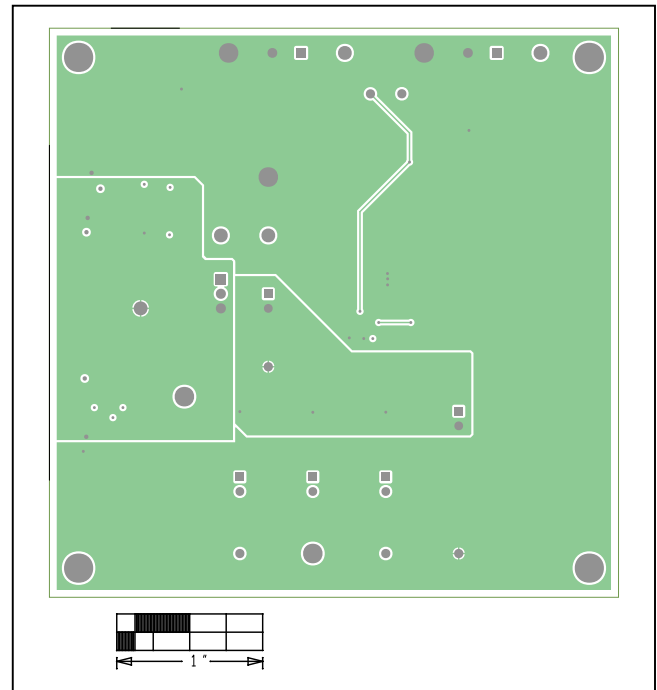

MAX20330 EV Kit—Internal 3

MAX20330 EV PCB Layout Diagrams (continued)

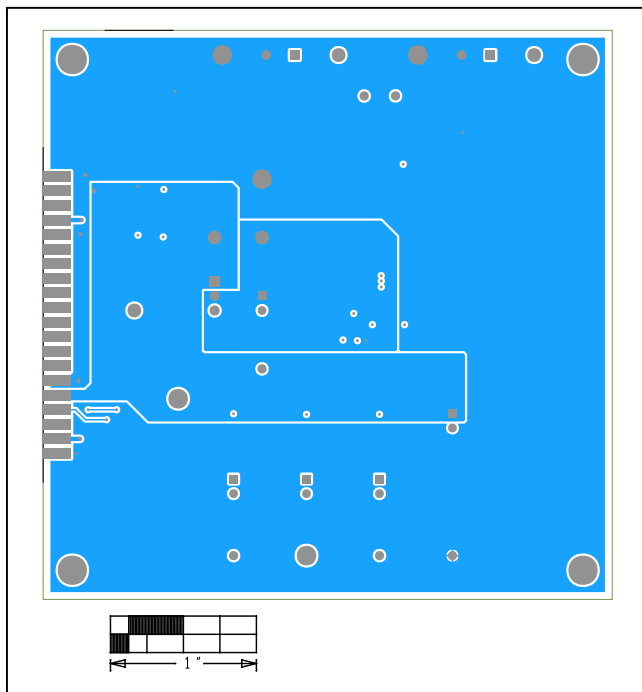

MAX20330 EV Kit—Bottom

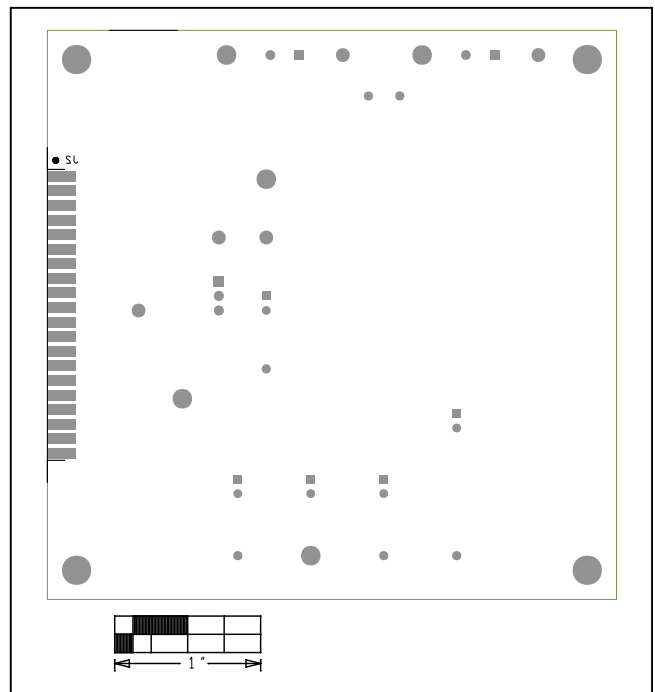

MAX20330 EV Kit—Bottom Silkscreen

## Revision History

REVISION NUMBER	REVISION DATE	DESCRIPTION	PAGES CHANGED
0	1/18	Initial release	—

For pricing, delivery, and ordering information, please contact Maxim Direct at 1-888-629-4642, or visit Maxim's website at [www.maximintegrated.com](http://www.maximintegrated.com).

*Maxim Integrated cannot assume responsibility for use of any circuitry other than circuitry entirely embodied in a Maxim Integrated product. No circuit patent licenses are implied. Maxim Integrated reserves the right to change the circuitry and specifications without notice at any time. The parametric values (min and max limits) shown in the Electrical Characteristics table are guaranteed. Other parametric values quoted in this data sheet are provided for guidance.*

## X-ON Electronics

Largest Supplier of Electrical and Electronic Components

*Click to view similar products for [Power Management IC Development Tools](#) category:*

*Click to view products by [Maxim](#) manufacturer:*

Other Similar products are found below :

[EVB-EP5348UI](#) [MIC23451-AAAYFL EV](#) [MIC5281YMME EV](#) [124352-HMC860LP3E](#) [DA9063-EVAL](#) [ADP122-3.3-EVALZ](#) [ADP130-0.8-EVALZ](#) [ADP130-1.8-EVALZ](#) [ADP1740-1.5-EVALZ](#) [ADP1870-0.3-EVALZ](#) [ADP1874-0.3-EVALZ](#) [ADP199CB-EVALZ](#) [ADP2102-1.25-EVALZ](#) [ADP2102-1.875EVALZ](#) [ADP2102-1.8-EVALZ](#) [ADP2102-2-EVALZ](#) [ADP2102-3-EVALZ](#) [ADP2102-4-EVALZ](#) [AS3606-DB](#) [BQ25010EVM](#) [BQ3055EVM](#) [ISLUSBI2CKIT1Z](#) [LP38512TS-1.8EV](#) [EVAL-ADM1186-1MBZ](#) [EVAL-ADM1186-2MBZ](#) [ADP122UJZ-REDYKIT](#) [ADP166Z-REDYKIT](#) [ADP170-1.8-EVALZ](#) [ADP171-EVALZ](#) [ADP1853-EVALZ](#) [ADP1873-0.3-EVALZ](#) [ADP198CP-EVALZ](#) [ADP2102-1.0-EVALZ](#) [ADP2102-1-EVALZ](#) [ADP2107-1.8-EVALZ](#) [ADP5020CP-EVALZ](#) [CC-ACC-DBMX-51](#) [ATPL230A-EK](#) [MIC23250-S4YMT EV](#) [MIC26603YJL EV](#) [MIC33050-SYHL EV](#) [TPS60100EVM-131](#) [TPS65010EVM-230](#) [TPS71933-28EVM-213](#) [TPS72728YFFEVM-407](#) [TPS79318YEQEVM](#) [UCC28810EVM-002](#) [XILINXPWR-083](#) [LMR22007YMINI-EVM](#) [LP38501ATJ-EV](#)