

Click [here](#) to ask about the production status of specific part numbers.

MAX20343/MAX20344

Ultra-Low Quiescent Current, Low Noise 3.5W Buck-Boost Regulator

General Description

The MAX20343/MAX20344 is an ultra-low quiescent current, non-inverting buck-boost converter with 1A current capability at 3.5V intended for applications that require long run times while also demanding bursts of high current. The device employs a unique control algorithm which seamlessly transitions between buck, buck-boost, and boost modes, minimizing discontinuities and subharmonics in the output voltage ripple. The low 1.9V input voltage for startup allows users to power the device from a variety of sources, and the near-zero minimum operating voltage gives the user the ability to extract as much as possible from their energy source. The MAX20343/MAX20344 has also been designed to keep inductance and output capacitance requirements as low as possible for space-constrained applications.

The MAX20343/MAX20344 is ideal for power in optical sensor applications as well as for powering radios in low power, wide area network (LPWAN) applications since in both cases noise must be minimal and efficiency must be high. For instance, the small light-load output voltage ripple allows a photoplethysmography (PPG) system to operate at low LED currents without interference. Additionally, seamless transitions between operating modes enables the use of dynamic voltage scaling (DVS) to minimize headroom on the LED and to save power in such systems. In applications where a low-power-density battery must be buffered by a super-capacitor to provide large LPWAN type bursts of current, the ultra-low operating voltage of the MAX20343/MAX20344 allows the user to extract as much energy as possible from the super capacitor. The low output inductance/capacitance requirement allows a small total solution size. For example in PPG systems, this provides the flexibility to place the MAX20343/MAX20344 on a remote optical module if overcrowding on the main PCB is an issue.

The MAX20343/MAX20344 is available with a highly configurable I²C serial interface or as a single-pin-enabled fixed-programming version. See [Table 3](#) for specific device settings. MAX20343 operates over the -40°C to +85°C temperature range, is available in a 16-bump, 1.77mm x 2.01mm, 0.4mm pitch WLP package and a 12-pin, 2.50mm x 2.50mm, 0.5mm pitch FC2QFN package. MAX20344 operates over the -40°C to +125°C temperature range, and is available in a 12-pin, 2.50mm x 2.50mm, 0.5mm pitch FC2QFN package.

Applications

- Biometric Optical Sensing Including PPG • IoT
- LPWAN (LTE/NB-IoT, LTE/Cat-M1) • Industrial Sensors

Benefits and Features

- Extend System Run Time
 - Ultra-Low, 3.5µA (typ) Quiescent Current
 - 250mW Output Power with 500mV Input Voltage
 - Dynamic Voltage Scaling (DVS)
- Low, Continuous Noise Profile
 - Eliminates Discontinuities Across Operating Voltage Range
 - Eliminates Post-Filtering LDO in Noise Sensitive Applications
- Adaptable Load Transient Response
 - Adjustable Peak Current for Optimal Performance in Each Application
 - Fast Load Transient Response Minimizes Settling Time
 - Optional Feedback Integrator
 - Enable for up to 3.5W Output Power Capabilities
 - Disable for up to 1.75W Output Power and Faster Load Transient Settling Time
 - FAST Pin Pretriggers Load Response and Offers Improved Load Transient
- Flexible Control Options
 - I²C Interface with Status Interrupts
 - EN and Status Pins, Single-Resistor V_{OUT} Selection (RSEL)
 - See [Table 3](#) for specific device defaults.
- Extended Operating Temperature from -40°C to +85°C (MAX20343), -40°C to +125°C (MAX20344)
- Optimally Sized for Small Applications
 - 16-bump, 1.77mm x 2.01mm, 0.4mm Pitch WLP
 - 12-pin, 2.50mm x 2.50mm, 0.5mm Pitch Flip-Chip QFN
 - Inductor/Capacitor Available in 0603/0402 Case Sizes

[Ordering Information](#) appears at end of data sheet.

Simplified Block Diagram

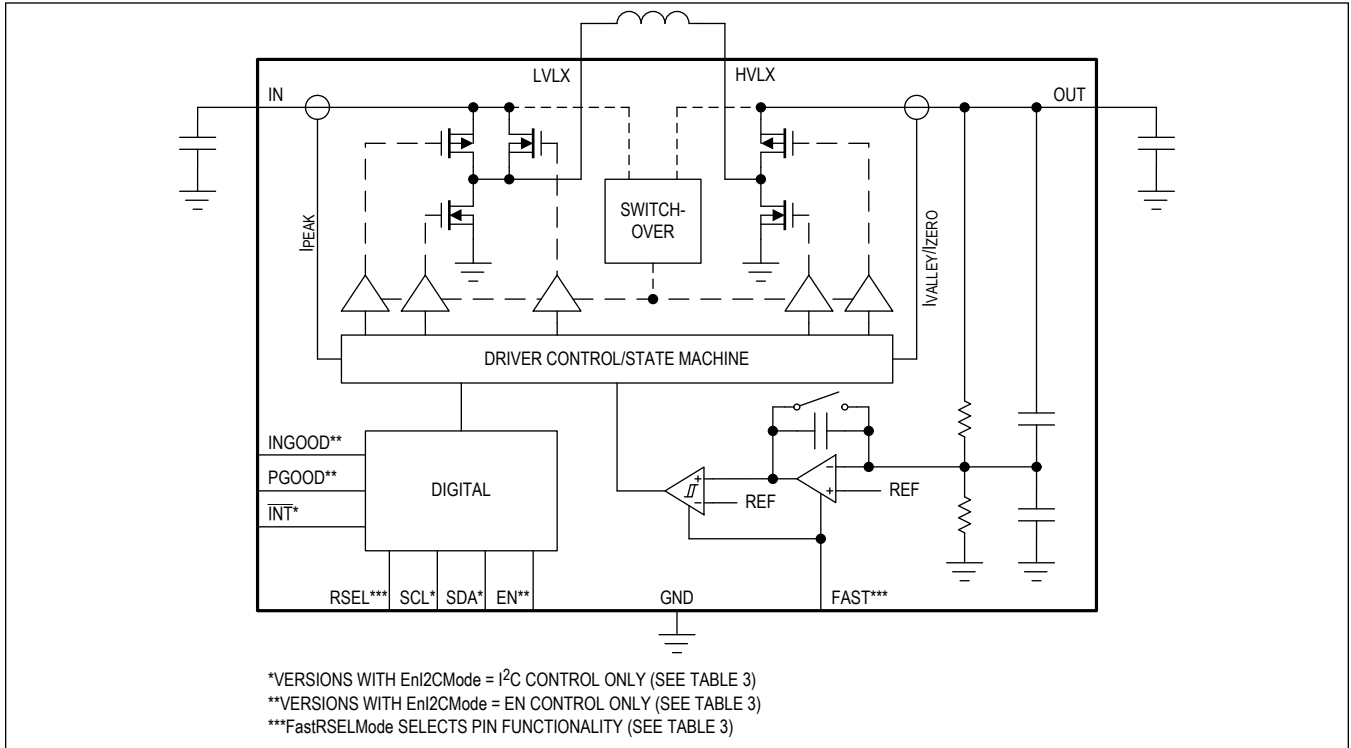

TABLE OF CONTENTS

General Description	1
Applications	1
Benefits and Features	1
Simplified Block Diagram	2
Absolute Maximum Ratings	7
Package Information	7
16-BUMP WLP	7
12-Pin FC2QFN	7
Electrical Characteristics	8
Typical Operating Characteristics	11
Pin Configurations	16
I ² C-Controlled WLP	16
Single-Pin-Enabled WLP	16
I ² C-Controlled FC2QFN	17
Single-Pin-Enabled FC2QFN	17
Pin Description	18
Functional Diagram	20
Functional Diagram	20
Detailed Description	21
Startup Voltage	21
Architectural Description	21
Switching Phases	21
Buck-Boost Mode	21
Buck-Only Mode	22
Inductor Peak and Valley Current Limits	22
Integrator Control Loop Disable	23
Input Operating Voltage	23
Output Operating Power and Other Optimizations	24
Device Control	24
I ² C-Controlled	24
Single-Pin-Enabled	25
Dynamic Voltage Scaling (DVS)	25
RSEL Voltage Setting	25
Register Map	28
MAX20343/MAX20344	28
Register Details	28
Applications Information	34
Input and Output Capacitance	34
Inductor Selection	35

TABLE OF CONTENTS (CONTINUED)

Soft-Start	35
I ² C Interface	35
Slave Address	35
Start, Stop, and Repeated Start Conditions	35
Bit Transfer	36
Single-Byte Write	36
Burst Write	36
Single Byte Read	37
Burst Read	37
Acknowledge Bits	38
Register Values	39
Typical Application Circuits	41
Optical Heart Rate LED Supply	41
LPWAN Radio Supply	41
Ordering Information	42
Revision History	43

LIST OF FIGURES

Figure 1. The Buck-Boost Regulator and Switching Phases	21
Figure 2. Buck-Boost Inductor Current in Buck-Boost Mode	21
Figure 3. Buck-Boost Inductor Current in Buck-Only Mode	22
Figure 4. Minimum BBstIPSet2 Limit for Given BBstIPSet1 Setting	23
Figure 5. Recommended BBstIPSet1 and BBstIPSet2 Settings	23
Figure 6. MAX20343/MAX20344 RSEL Startup Sequence	26
Figure 7. Buck-Boost Required Minimum Input/Output Capacitance	34
Figure 8. I ² C START, STOP, and REPEATED START Conditions	36
Figure 9. Write Byte Sequence	36
Figure 10. Burst Write Sequence	37
Figure 11. Read Byte Sequence	37
Figure 12. Burst Read Sequence	38
Figure 13. Acknowledge Bits	38

LIST OF TABLES

Table 1. RSEL SELECTION TABLE	26
Table 2. Characteristics and Device Settings	27
Table 3. Register Bit Default Values	39
Table 4. Register Default Values	40

Absolute Maximum Ratings

IN, OUT, SDA, SCL, EN, FAST, RSEL, PGOOD, INGOOD, INT, CAP.....	-0.3V to +6.0V	FC2QFN) (derate 17.04mW/°C above +70°C).....	1363.20mW
LVLX.....	-0.3V to V _{IN} + 0.3V	Operating Temperature Range	
HVLX.....	-0.3 to min(V _{OUT} + 0.3V, +6.0V)	MAX20343.....	-40°C to +85°C
Continuous Power Dissipation (Multilayer Board, T _A = +70°C) (4 x 4 Array 16-Ball, 1.77mm x 2.01mm, 0.4mm..		MAX20344.....	-40°C to +125°C
Pitch WLP) (derate 17.26mW/°C above +70°C)....	1380.80mW	Junction Temperature	+150°C
Continuous Power Dissipation (Multilayer Board, T _A = +70°C) (12-Pin, 2.50mm x 2.50mm, 0.5mm Pitch		Storage Temperature Range	-40°C to +150°C
		Soldering Temperature (reflow)	+260°C

Stresses beyond those listed under "Absolute Maximum Ratings" may cause permanent damage to the device. These are stress ratings only, and functional operation of the device at these or any other conditions beyond those indicated in the operational sections of the specifications is not implied. Exposure to absolute maximum rating conditions for extended periods may affect device reliability.

Package Information

16-BUMP WLP

Package Code	W161C2+1
Outline Number	21-100328
Land Pattern Number	Refer to Application Note 1891
THERMAL RESISTANCE, SINGLE-LAYER BOARD	
Junction-to-Ambient (θ _{JA})	
Junction-to-Case Thermal Resistance (θ _{JC})	
THERMAL RESISTANCE, FOUR-LAYER BOARD	
Junction-to-Ambient (θ _{JA})	57.93°C/W

12-Pin FC2QFN

Package Code	F122B2F+1
Outline Number	21-100331
Land Pattern Number	90-100130
THERMAL RESISTANCE, SINGLE-LAYER BOARD	
Junction-to-Ambient (θ _{JA})	
Junction-to-Case Thermal Resistance (θ _{JC})	
THERMAL RESISTANCE, FOUR-LAYER BOARD	
Junction-to-Ambient (θ _{JA})	58.70°C/W
Junction-to-Case Thermal Resistance (θ _{JC})	23.10°C/W

For the latest package outline information and land patterns (footprints), go to www.maximintegrated.com/packages. Note that a "+", "#", or "-" in the package code indicates RoHS status only. Package drawings may show a different suffix character, but the drawing pertains to the package regardless of RoHS status.

Package thermal resistances were obtained using the method described in JEDEC specification JESD51-7, using a four-layer board. For detailed information on package thermal considerations, refer to www.maximintegrated.com/thermal-tutorial.

Electrical Characteristics

($V_{IN} = +1.8V$ to $+5.5V$, $C_{IN} = 5\mu F$, $C_{OUT} = 8\mu F$, $T_J = -40^\circ C$ to $+125^\circ C$, unless otherwise noted. Typical values are at $T_A = +25^\circ C$, $V_{IN} = +3.7V$, $L = 1\mu H$, Limits are 100% tested at $T_A = +25^\circ C$.) (Note 1)

PARAMETER	SYMBOL	CONDITIONS	MIN	TYP	MAX	UNITS
BUCK-BOOST						
Input Voltage Range	V_{IN_START}	Input voltage required for startup (Note 2)	1.9		5.5	V
Quiescent Supply Current	I_Q	No load, $V_{OUT} = 5V$, $V_{IN} = 3.7V$	$SwoFrcIN = 1$, $T_A = +85^\circ C$ (MAX20343)	3.51	5	μA
			$SwoFrcIN = 1$, $T_A = +125^\circ C$ (MAX20344)		12.5	
	I_{Q_FAST}		FAST = 1	35		μA
Shutdown Supply Current	I_{SHDN}	I ² C controlled		0.3		μA
Maximum Output Operative Power (Note 3)	P_{MAX}	Integrator enabled, $V_{IN} > 2.7V$, $V_{OUT} \geq 3.2V$	$BBstFETScale = 0$, $L = 1\mu H$, $C_{OUT} = 8\mu F$	3.5		W
			$BBstFETScale = 1$, $L = 2.2\mu H$, $C_{OUT} = 4\mu F$	1.75		
		Integrator disabled, $V_{IN} > 3.2V$ (Note 4), $V_{OUT} \geq 3.2V$	$BBstFETScale = 0$, $L = 1\mu H$, $C_{OUT} = 8\mu F$, $T_A = +85^\circ C$ (MAX20343)	3.2		
			$BBstFETScale = 0$, $L = 1\mu H$, $C_{OUT} = 8\mu F$, $T_A = +125^\circ C$ (MAX20344)	2.9		
			$BBstFETScale = 1$, $L = 2.2\mu H$, $C_{OUT} = 4\mu F$, $T_A = +85^\circ C$ (MAX20343)	1.75		
			$BBstFETScale = 1$, $L = 2.2\mu H$, $C_{OUT} = 4\mu F$, $T_A = +125^\circ C$ (MAX20344)	1.6		
Output-Voltage Set Range	V_{OUT}	50mV step resolution		2.5	5.5	V
			$V_{IN} < 2.1V$, $SwoFrcIN = 0$ (see the Input Operating Voltage section)	3.2	5.5	
Average Output-Voltage Accuracy	ACC_OUT	$I_{OUT} = 1mA$, $C_{OUT_EFF} = 8\mu F$	-2.4		+2.4	%
Line Regulation Error	V_{LINE_REG}		-1		+1	%/V
Load Regulation Error	V_{LOAD_REG}	Integrator enabled, $V_{IN} = 2.7V$, $V_{OUT} = 3.3V$, $BBstFETScale = 0$, $P_{OUT} = 3.5W$		-1		%
		Integrator disabled, $V_{IN} = 3.7V$, $V_{OUT} = 5V$, $P_{OUT} = 1.5W$, $BBstFETScale = 1$, $C_{OUT} = 4\mu F$, $L = 2.2\mu H$		-3.2		

Electrical Characteristics (continued)

($V_{IN} = +1.8V$ to $+5.5V$, $C_{IN} = 5\mu F$, $C_{OUT} = 8\mu F$, $T_J = -40^\circ C$ to $+125^\circ C$, unless otherwise noted. Typical values are at $T_A = +25^\circ C$, $V_{IN} = +3.7V$, $L = 1\mu H$, Limits are 100% tested at $T_A = +25^\circ C$.) (Note 1)

PARAMETER	SYMBOL	CONDITIONS		MIN	TYP	MAX	UNITS
Line Transient Response	V_{LINE_TRAN}	$V_{OUT} = 3.4V$, V_{IN} from 3.4V to 2.9V, 1 μs fall time, $I_{LOAD} = 750mA$, $BBstIntegEn = 1$, $SwoFrcIN = 0$			0		mV
Load Transient Response	V_{LOAD_TRAN}	$V_{OUT} = 5V$, $V_{IN} = 3.7V$, $I_{LOAD} = 10\mu A$ to 700mA, $BBstIntegEn = 1$			-150		mV
Input Supply Current During Startup	I_{IN_STUP}	$V_{IN} = 3.6V$, $V_{OUT} = 5V$, $I_{LOAD} = 0$			1		mA/ $C_{OUT}(\mu F)$
Maximum Output Power During Startup (Note 3)	$I_{PWR_MAX_STUP}$	$BBstFETScale = 0$		400	600		mW
		$BBstFETScale = 1$		200	300		
Startup Time	$t_{STARTUP}$	Time from $V_{OUT} = 0V$ to final value	I^2C controlled		9.6		ms
			RSEL, $BBstRampEn = 0$		32		
PGOOD Threshold	V_{PGOOD}				84.7		% V_{OUT}
PGOOD Threshold Hysteresis	V_{PGOOD_HYS}				2.25		% V_{OUT}
Active Discharge Current	I_{ACTD}				20		mA
Passive Discharge Resistance	R_{PSVD}				1.2		k Ω
Input UVLO Rising Threshold	$V_{IN_UVLO_R}$	V_{IN} rising	Soft-start active, $SwoFrcIN = 1$, or V_{OUT} set below 3.3V		1.836		V
			V_{OUT} set higher than 3.3V, $SwoFrcIN = 0$, soft-start period complete		2.185		
Input UVLO Falling Threshold	$V_{IN_UVLO_F}$	V_{IN} falling	Soft-start active, $SwoFrcIN = 1$, or V_{OUT} set below 3.3V		1.782		V
			V_{OUT} set higher than 3.3V, $SwoFrcIN = 0$, soft-start period complete		2.101		
Output UVLO Falling Threshold	$V_{OUT_UVLO_F}$	V_{OUT} falling			1.873		V
Output UVLO Rising Threshold	$V_{OUT_UVLO_R}$	V_{OUT} rising			1.963		V
DIGITAL							
SDA, EN, SCL, \overline{INT} , PGOOD, INGOOD FAST, RSEL Input Leakage Current	I_{LK_IO}	$T_J = +25^\circ C$		-1		+1	μA

Electrical Characteristics (continued)

($V_{IN} = +1.8V$ to $+5.5V$, $C_{IN} = 5\mu F$, $C_{OUT} = 8\mu F$, $T_J = -40^\circ C$ to $+125^\circ C$, unless otherwise noted. Typical values are at $T_A = +25^\circ C$, $V_{IN} = +3.7V$, $L = 1\mu H$, Limits are 100% tested at $T_A = +25^\circ C$.) (Note 1)

PARAMETER	SYMBOL	CONDITIONS	MIN	TYP	MAX	UNITS
SDA, EN, SCL, FAST Input Logic High	V_{IO_IH}		1.4			V
SDA, EN, SCL, FAST Input Logic Low	V_{IO_IL}				0.4	V
SDA, \overline{INT} , PGOOD, INGOOD Output Logic Low	V_{IO_OL}	$I_{OL} = 4mA$			0.4	V
SCL Clock Frequency	f_{SCL}	MAX20343B/E/F/G/I, MAX20344E	400		680	kHz
		All other versions			680	
Bus Free Time Between STOP and START Condition	t_{BUF}		0.75			μs
START Condition (Repeated) Hold Time	t_{HD_STA}	(Note 5)	0.35			μs
Low Period of SCL Clock	t_{LOW}		0.75			μs
High Period of SCL Clock	t_{HIGH}		0.35			μs
Setup Time for a Repeated START Condition	t_{SU_STA}		0.35			μs
Data Hold Time	t_{HD_DAT}	(Note 6)	0		0.53	μs
Data Setup Time	t_{SU_DAT}		100			ns
Setup Time for STOP Condition	t_{SU_STO}		0.35			μs
Spike Pulse Widths Suppressed by Input Filter	t_{SP}		50			ns

Note 1: All devices are 100% production tested at $T_A = +25^\circ C$. Limits over the operating temperature range are guaranteed by design.

Note 2: Output power across the input operating voltage range is limited by input current. Refer to TOC03 for details on how the power limit changes with V_{IN} .

Note 3: The parameter is not production tested and values are generated through characterization only.

Note 4: Operation down to 2.7V is supported with the integrator disabled, but stability is only guaranteed up to 1.75W output power. Beyond 1.75W, oscillations could occur unless output capacitance is increased.

Note 5: f_{SCL} must meet the minimum clock low time plus the rise/fall times.

Note 6: The maximum t_{HD_DAT} has to be met only if the device does not stretch the low period (t_{LOW}) of the SCL signal.

Typical Operating Characteristics

($V_{IN} = +3.7V$, $C_{IN} = GRM155R60J226ME11$, refer to [Figure 7](#) single capacitor derating, $C_{OUT} = 2x GRM155R60J226ME11$, $L = 1\mu H$, $BBstZCCmpDis = 0$, $BBstLowEMI = 0$, $BBstMode = 0$, $SwoFrcIN = 1$, $BBstIPAdptDis = 0$, $BBstFETScale = 0$, $T_A = +25^\circ C$, unless otherwise noted.)

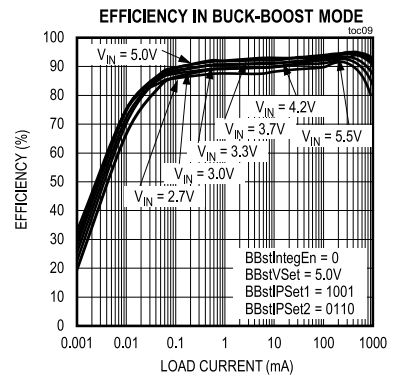
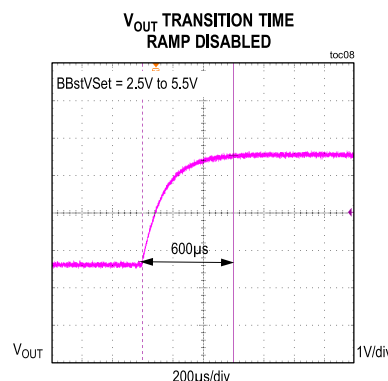
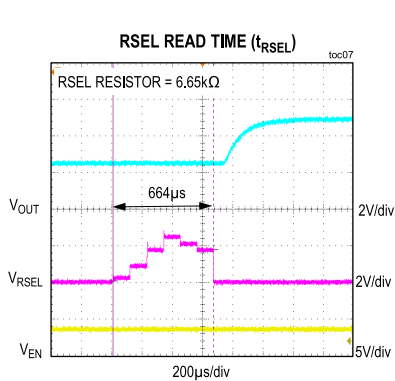
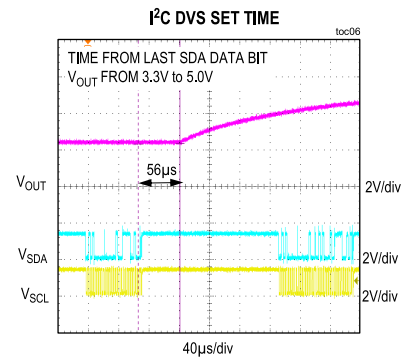
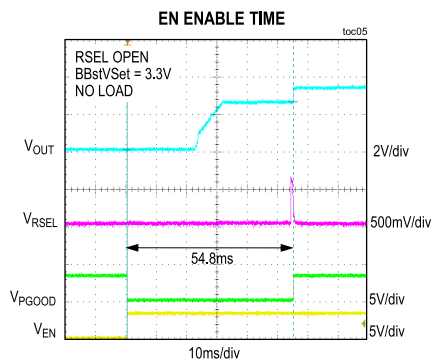
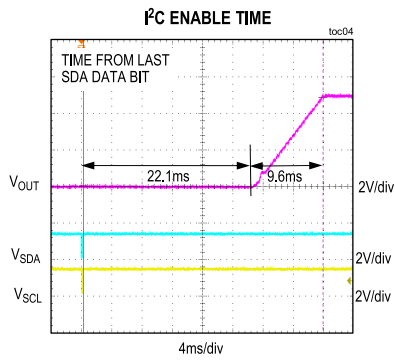
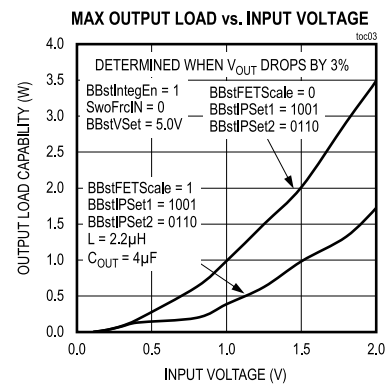
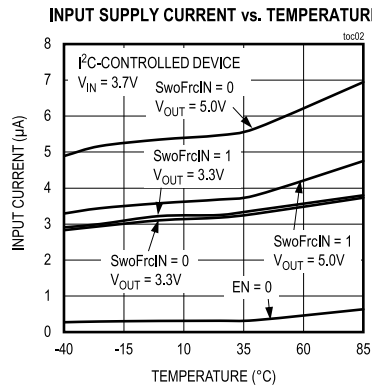
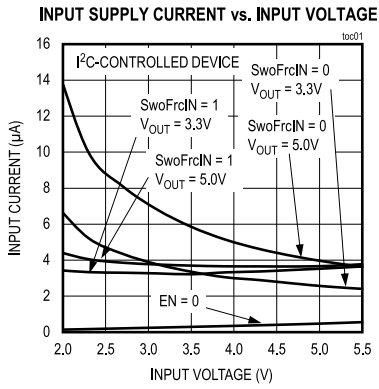

Typical Operating Characteristics (continued)

($V_{IN} = +3.7V$, $C_{IN} = GRM155R60J226ME11$, refer to [Figure 7](#) single capacitor derating, $C_{OUT} = 2x GRM155R60J226ME11$, $L = 1\mu H$, $BBstZCCmpDis = 0$, $BBstLowEMI = 0$, $BBstMode = 0$, $SwoFrcIN = 1$, $BBstIPAdptDis = 0$, $BBstFETScale = 0$, $T_A = +25^\circ C$, unless otherwise noted.)

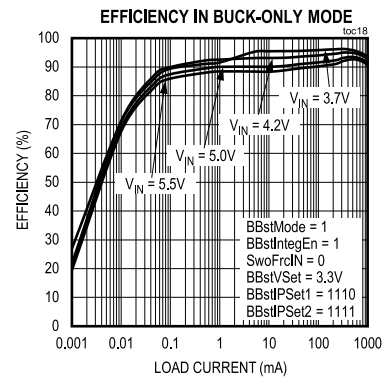
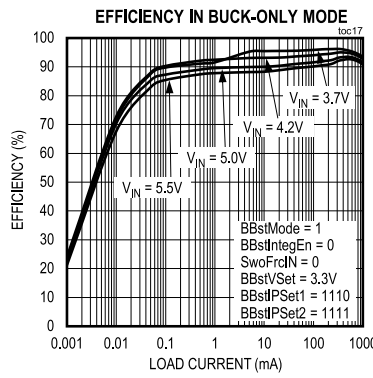
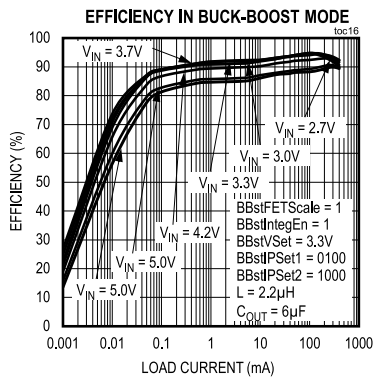
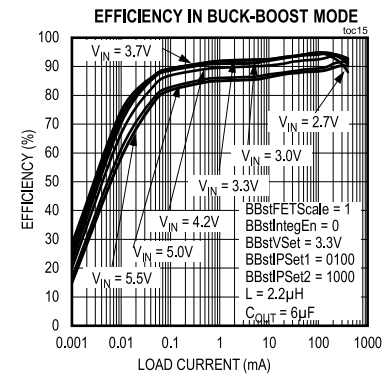
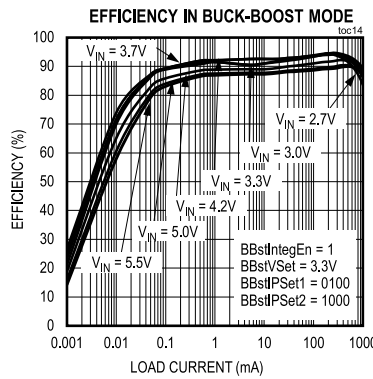
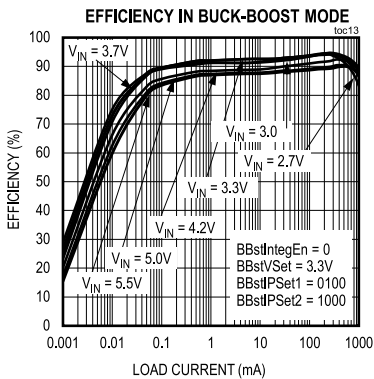
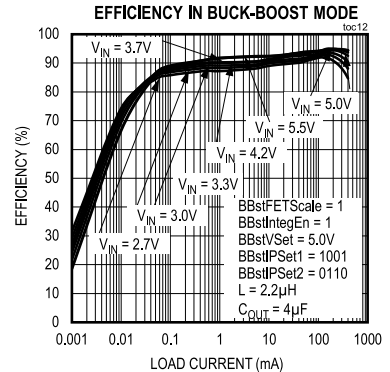
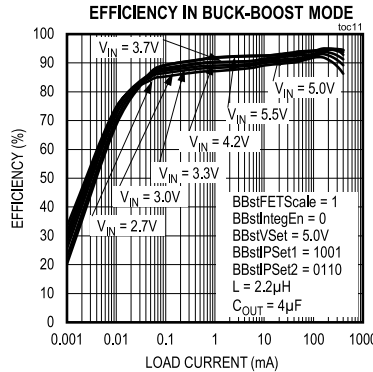
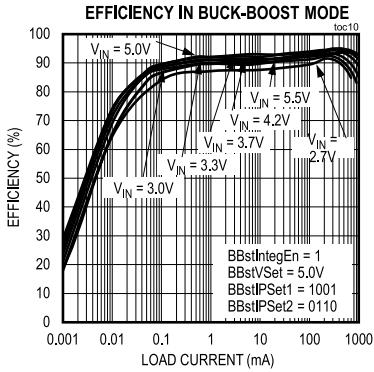

Typical Operating Characteristics (continued)

($V_{IN} = +3.7V$, $C_{IN} = GRM155R60J226ME11$, refer to [Figure 7](#) single capacitor derating, $C_{OUT} = 2x GRM155R60J226ME11$, $L = 1\mu H$, $BBstZCCmpDis = 0$, $BBstLowEMI = 0$, $BBstMode = 0$, $SwoFrcIN = 1$, $BBstIPAdptDis = 0$, $BBstFETScale = 0$, $T_A = +25^\circ C$, unless otherwise noted.)

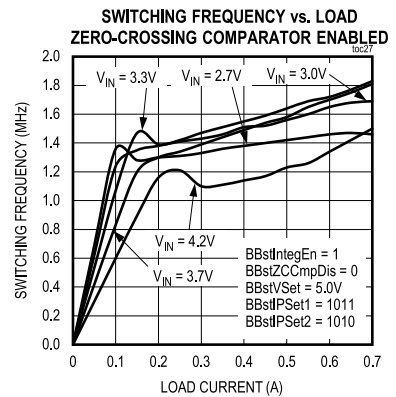
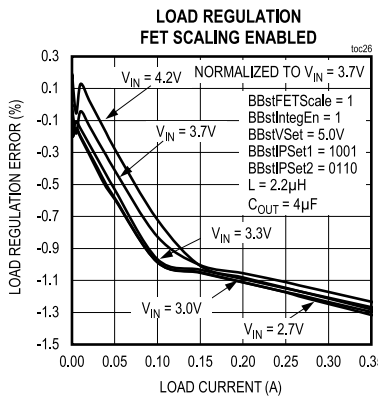
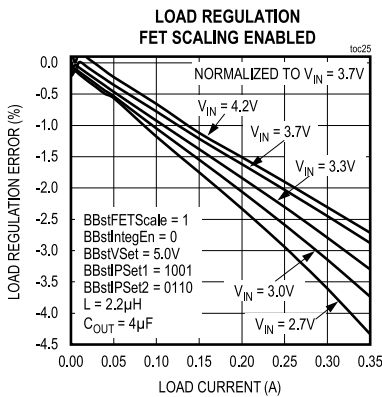
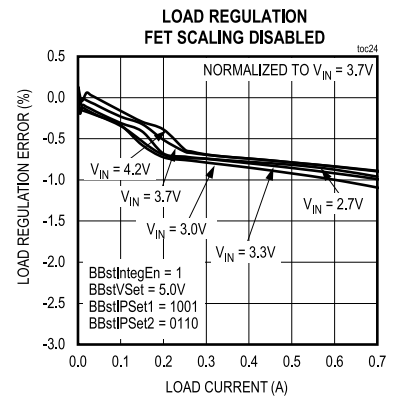
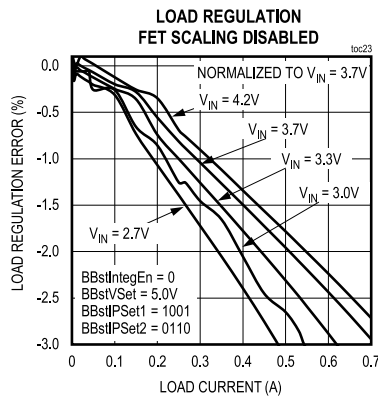
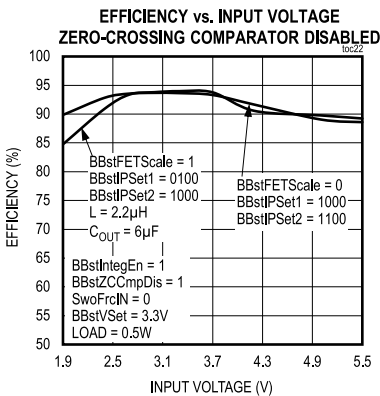
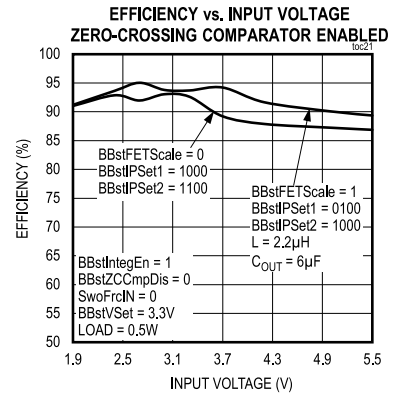
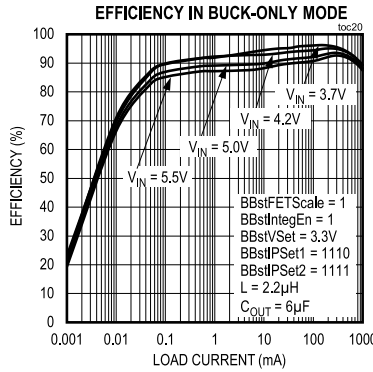
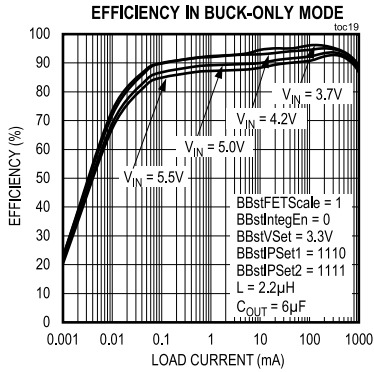

Typical Operating Characteristics (continued)

($V_{IN} = +3.7V$, $C_{IN} = GRM155R60J226ME11$, refer to [Figure 7](#) single capacitor derating, $C_{OUT} = 2x GRM155R60J226ME11$, $L = 1\mu H$, $BBstZCCmpDis = 0$, $BBstLowEMI = 0$, $BBstMode = 0$, $SwoFrcIN = 1$, $BBstIPAdptDis = 0$, $BBstFETScale = 0$, $T_A = +25^{\circ}C$, unless otherwise noted.)

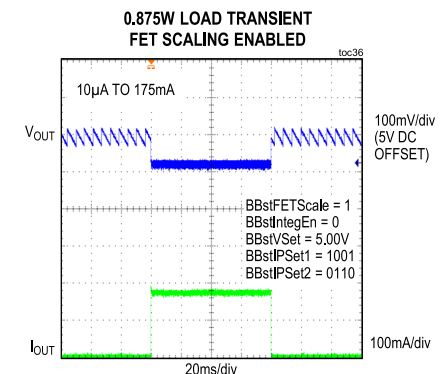
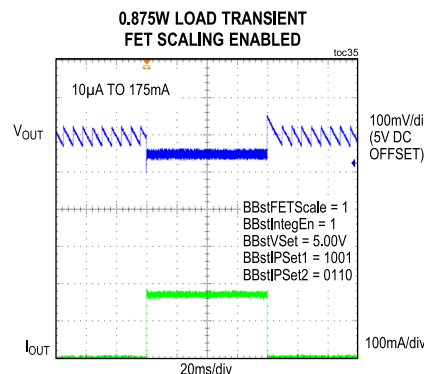
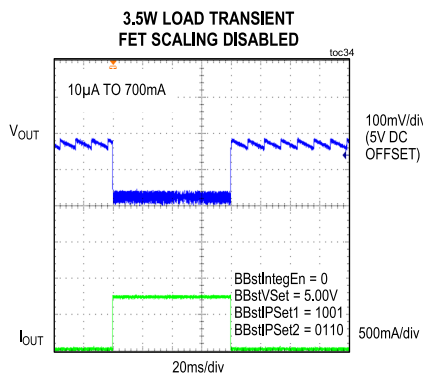
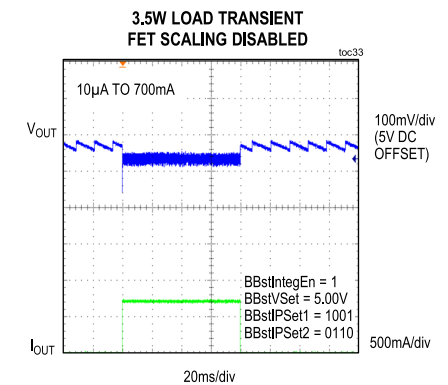
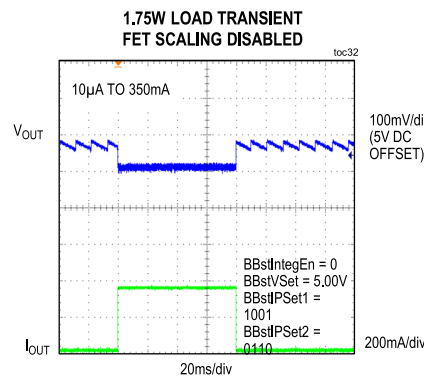
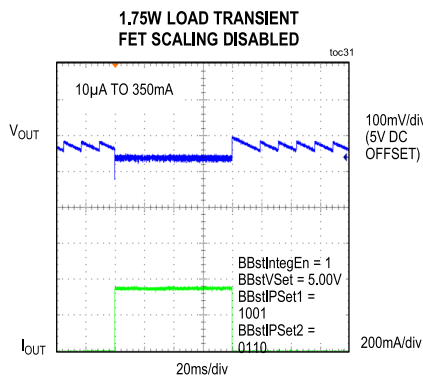
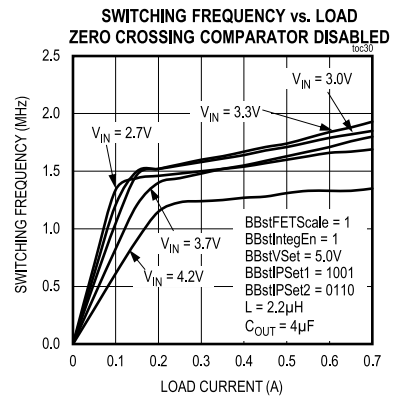
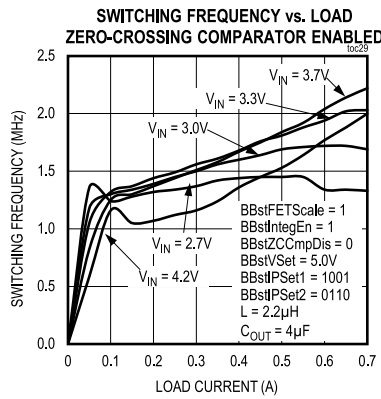
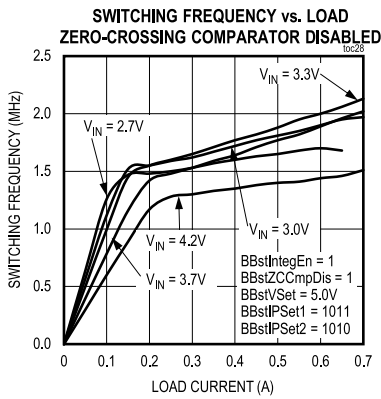

Typical Operating Characteristics (continued)

($V_{IN} = +3.7V$, $C_{IN} = GRM155R60J226ME11$, refer to [Figure 7](#) single capacitor derating, $C_{OUT} = 2x GRM155R60J226ME11$, $L = 1\mu H$, $BBstZCCmpDis = 0$, $BBstLowEMI = 0$, $BBstMode = 0$, $SwoFrcIN = 1$, $BBstIPAdptDis = 0$, $BBstFETScale = 0$, $T_A = +25^\circ C$, unless otherwise noted.)

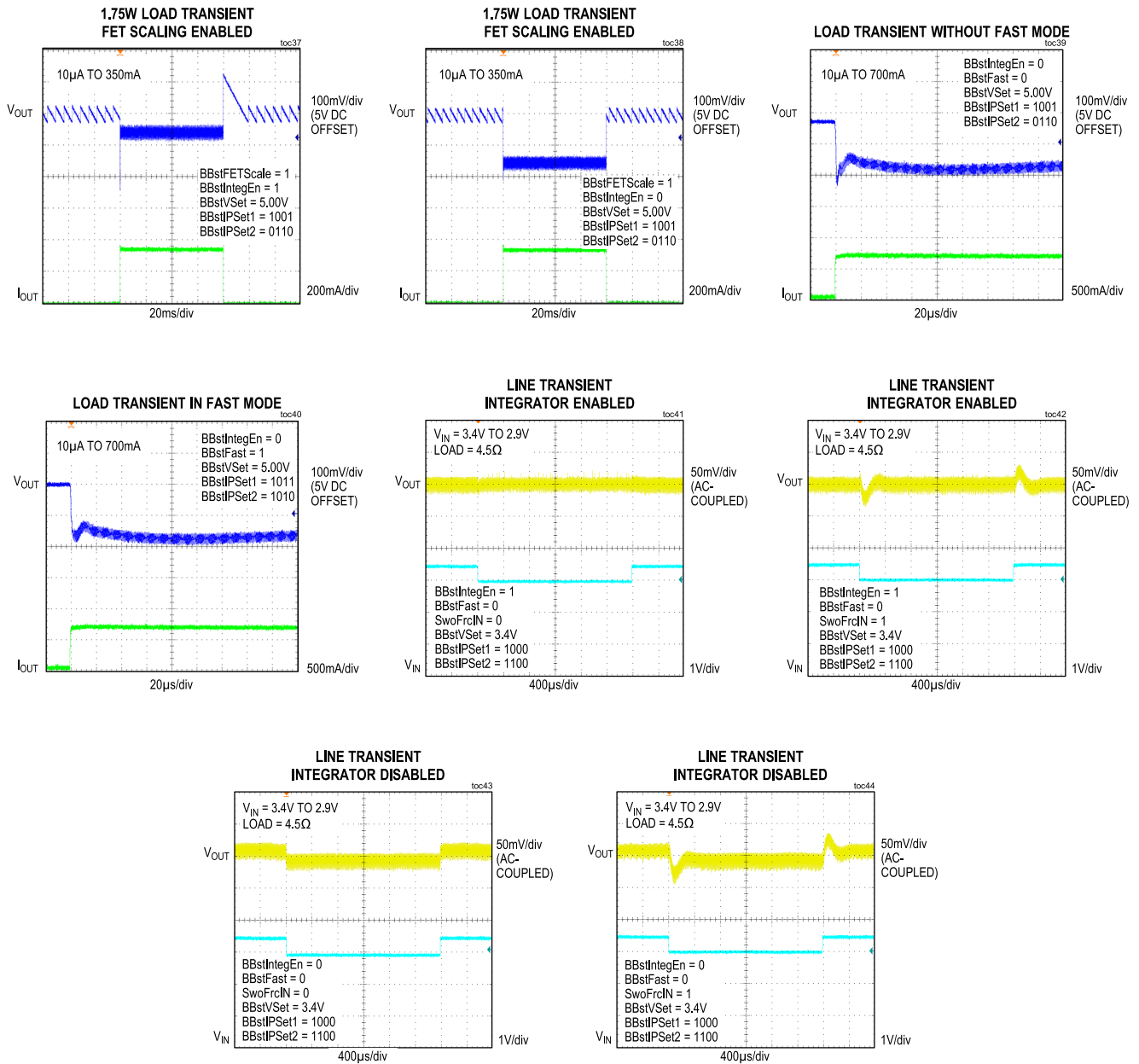

Pin Configurations

I²C-Controlled WLP

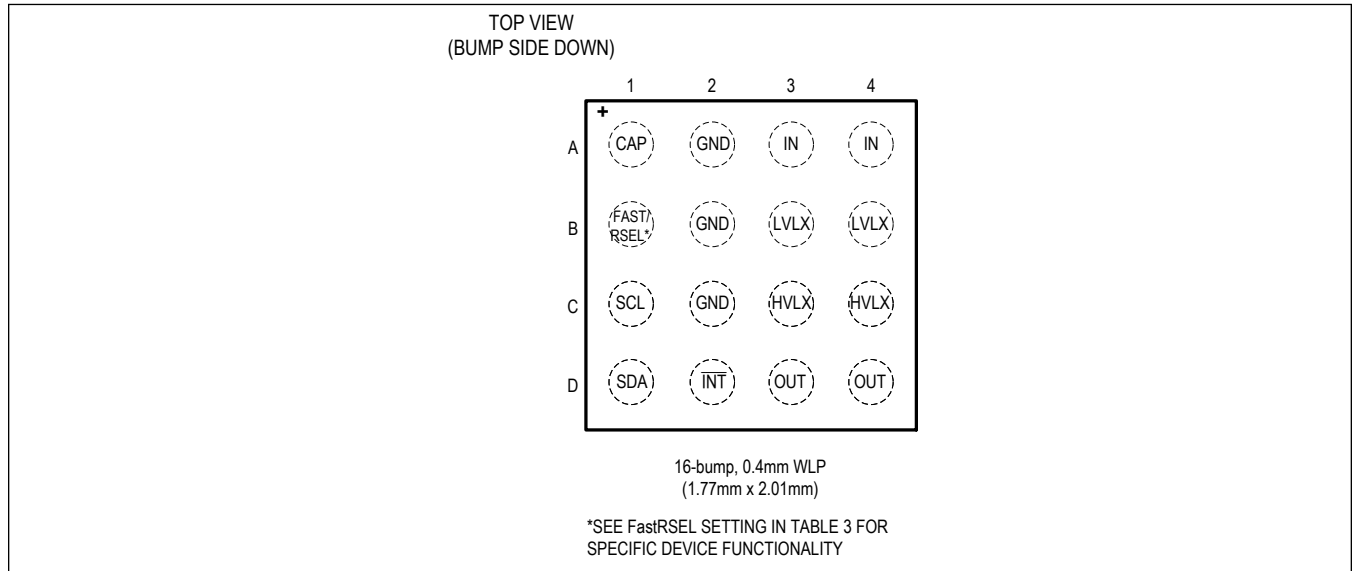

Single-Pin-Enabled WLP

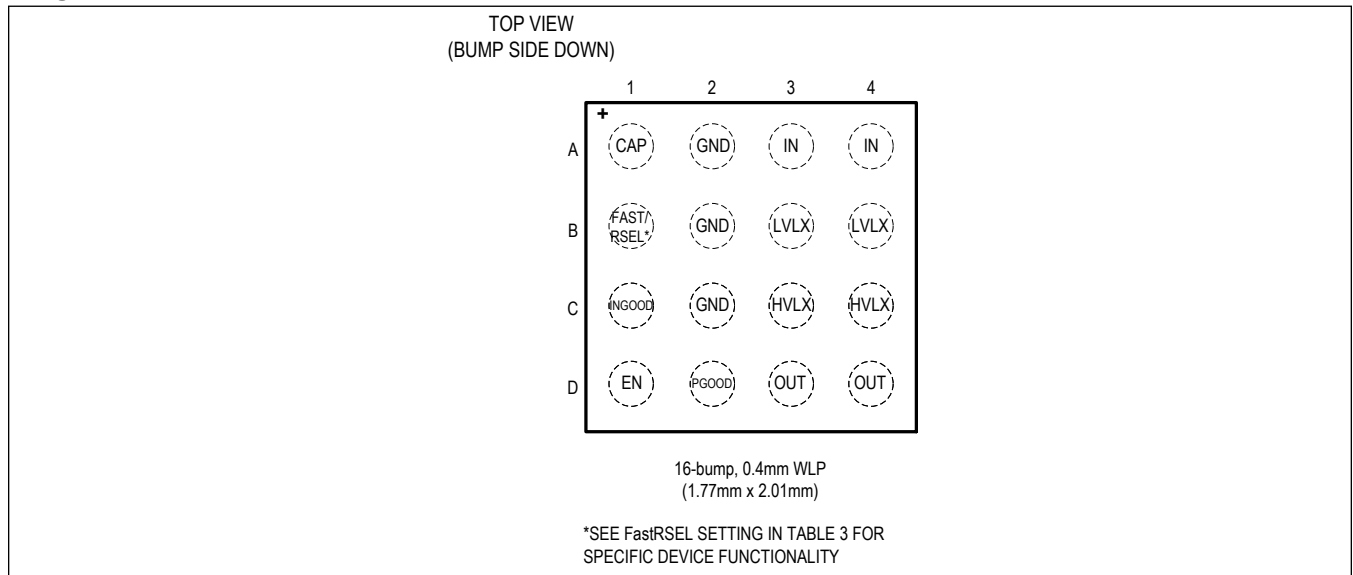

I²C-Controlled FC2QFN

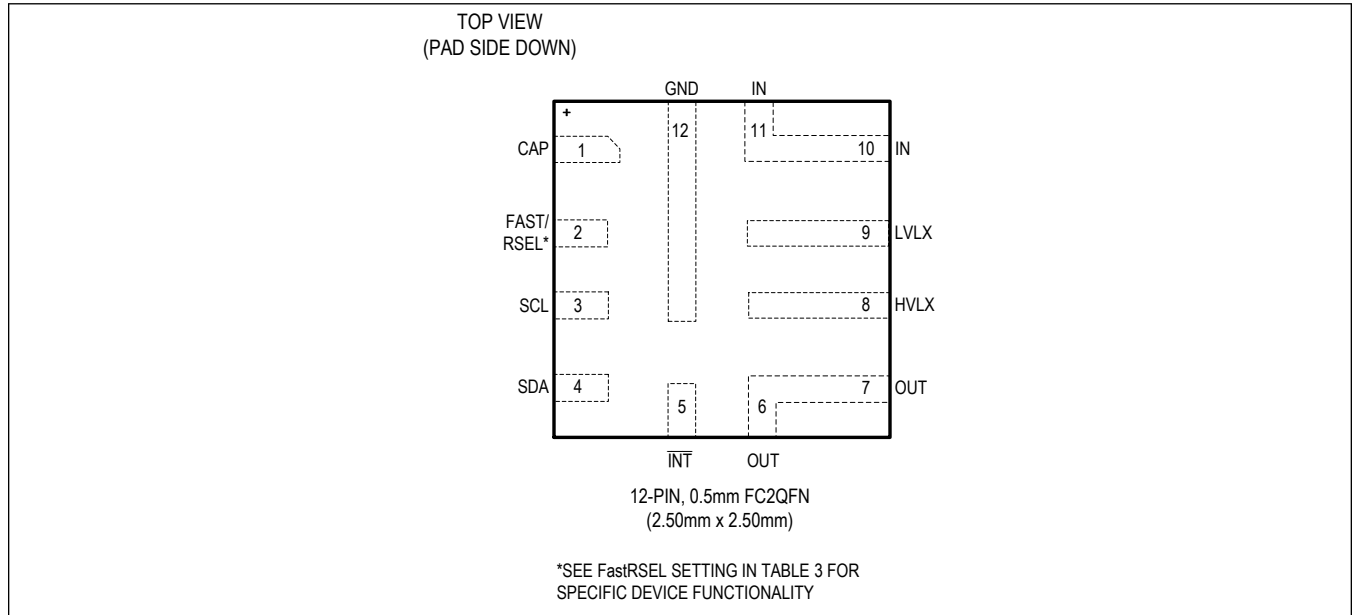

Single-Pin-Enabled FC2QFN

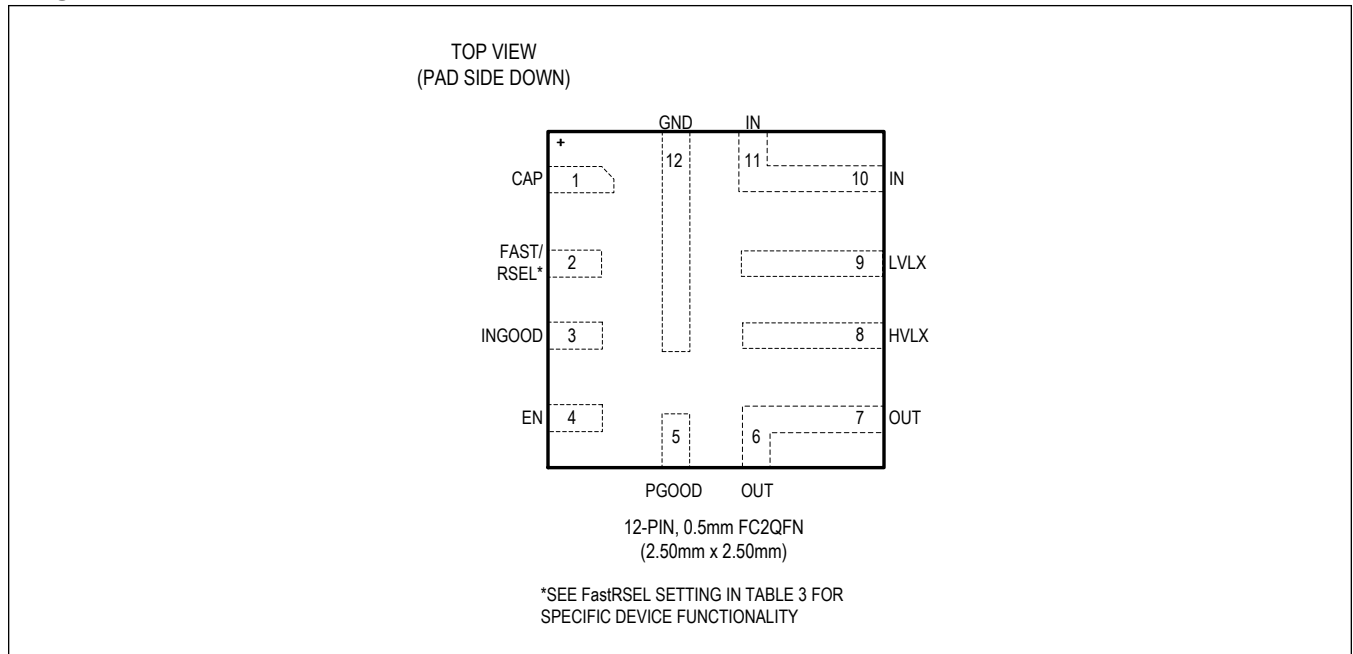

Pin Description

PIN				NAME	FUNCTION
I ² C- Controlled WLP	Single-Pin- Enabled WLP	I ² C- Controlled FC2QFN	Single-Pin- Enabled FC2QFN		
A1	A1	1	1	CAP	Bypass Capacitor Connection for Internal Supply. Connect through 470nF of capacitance to GND.
A2, B2, C2	A2, B2, C2	12	12	GND	Ground
A3, A4	A3, A4	10, 11	10, 11	IN	Input Supply. Bypass to GND with effective capacitance equal to the minimum of 5 μ F and the value of the derating curve (Figure 7) for a bias voltage V_{IN} placed as close to the device as possible.
B1	B1	2	2	FAST	Fast Transient Response. When FAST is high, the quiescent current of MAX20343/MAX20344 increases in order to improve response time to a load step. When FAST is low, the quiescent current is decreased to save power. The function of B1 is determined by the factory configuration of the device. See FastRSEL in Table 3 for the specific configuration of each device.
B1	B1	2	2	RSEL	Output Voltage Select. Connect a resistor from RSEL to GND based on the desired output voltage. See Figure 6. The function of B1 is determined by the factory configuration of the device. See FastRSEL in Table 3 for the specific configuration of each device.
B3, B4	B3, B4	9	9	LVLX	Switching Node. Connect to HVLX through a 1 μ H inductor if BBstFETScale = 0 or a 2.2 μ H inductor if BBstFETScale = 1.
C1	—	3	—	SCL	I ² C Serial Clock Input. For I ² C versions, note the BBstEn setting. If a version is disabled by default an externally supplied source must be used for the I ² C interface to enable the output by I ² C command.
—	C1	—	3	INGOOD	Input Power Good. LOW indicates that the CAP pin voltage is forced to V_{OUT} and the input voltage is below $V_{IN_UVLO_F}$ when $V_{OUT} \geq 3.3V$ and the soft-start period is complete. Power capabilities might be limited. If CAP is forced to V_{IN} , INGOOD does not function when $V_{IN} < V_{IN_UVLO_F}$. It is an open drain output and should be connected to an external logic supply using a pullup resistor.
C3, C4	C3, C4	8	8	HVLX	Switching Node. Connect to LVLX through a 1 μ H inductor if BBstFETScale = 0 or a 2.2 μ H inductor if BBstFETScale = 1.
D1	—	4	—	SDA	I ² C Serial Data Input/Open-Drain Output. For I ² C versions, note the BBstEn setting. If a version is disabled by default an externally supplied source must be used for the I ² C interface to enable the output by I ² C command.
—	D1	—	4	EN	Enable. Active-high.

Pin Description (continued)

PIN				NAME	FUNCTION
I ² C- Controlled WLP	Single-Pin- Enabled WLP	I ² C- Controlled FC2QFN	Single-Pin- Enabled FC2QFN		
D2	—	5	—	$\overline{\text{INT}}$	Interrupt Output. Open-drain, connect through pullup resistor to system logic supply.
—	D2	—	5	PGOOD	Power Good Output. Indicates when output is ready for use. It is an open drain output and should be connected to an external logic supply using a pullup resistor.
D3, D4	D3, D4	6, 7	6, 7	OUT	Buck-Boost Output. If BBstFETScale = 0, bypass to GND with effective capacitance equal to twice the value of the derating curve (Figure 7) for a bias voltage V_{OUT} , placed as close to the device as possible. If BBstFETScale = 1, bypass to GND with effective capacitance equal to the value of the derating curve (Figure 7) for a bias voltage V_{OUT} , placed as close to the device as possible.

Functional Diagram

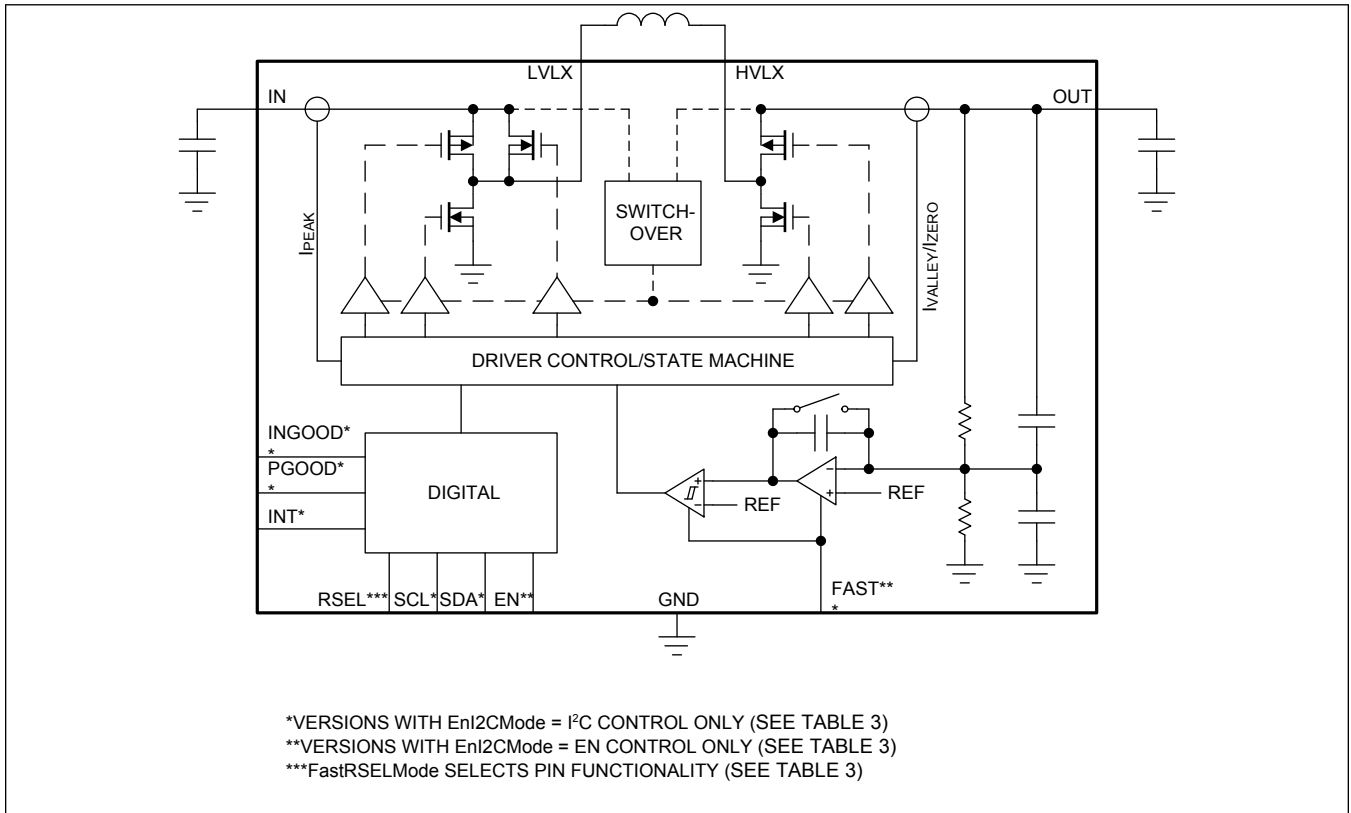

Detailed Description

The MAX20343/MAX20344 is an ultra-low quiescent current, non-inverting buck-boost converter with 1A current capability at 3.5V intended for applications that require long run times while also demanding bursts of high current. A peak/valley current-controlled hysteretic architecture yields a fast transient response time with minimal settling time that allows the device to handle large load transients in high peak-power applications. The device has a unique control algorithm that seamlessly transitions between buck, buck-boost, and boost operation to minimize discontinuities and sub-harmonic noise in the output ripple.

The low, 1.9V startup voltage is compatible with a variety of power sources, and the near-zero minimum operating voltage extracts as much energy as possible from the source. Low inductance and capacitance requirements allow for a small total-solution size and make the MAX20343/MAX20344 well-suited for space-constrained applications. The device has a high efficiency and low noise that also makes it suitable for wireless and noise-sensitive applications such as LPWAN and optical sensor systems. It has an ultra-low, 3.5 μ A (typ) quiescent current and discontinuous conduction mode (DCM) to operate at low loads and extend run time in low average-power, battery-powered applications.

Startup Voltage

The MAX20343/MAX20344 is guaranteed to start up with a minimum input voltage of 1.9V. After device startup, an internal bootstrapping function allows the device to operate down to a 0.5V input. See the [Input Operating Voltage](#) section for more details.

Architectural Description

The MAX20343/MAX20344 buck-boost comprises a typical non-inverting buck-boost topology. [Figure 1](#) illustrates the basic structure of the regulator with arrows depicting the inductor current flow in each switching phase.

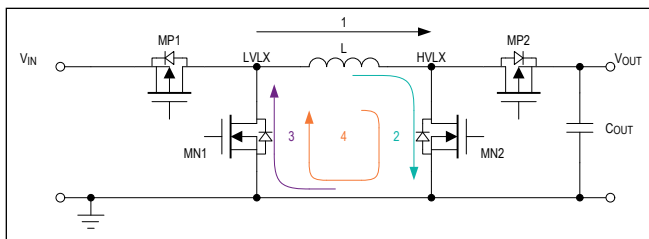

Figure 1. The Buck-Boost Regulator and Switching Phases

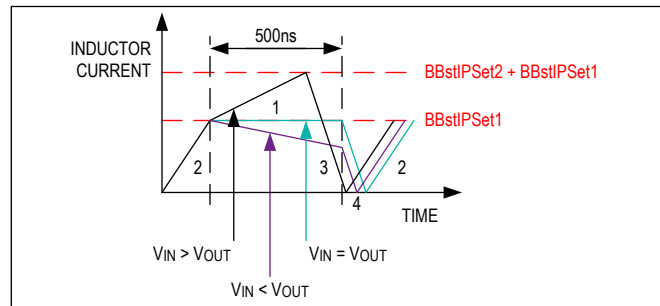

Figure 2. Buck-Boost Inductor Current in Buck-Boost Mode

Switching Phases

Depending on the buck-boost configurations, the topology enters different sequences of phases to generate the desired output voltage. Only two switches are on in each phase.

- Phase 1: MP1 on, MP2 on. Inductor charges.
- Phase 2: MP1 on, MN2 on. Inductor charges.
- Phase 3: MN1 on, MP2 on. Inductor discharges.
- Phase 4: MN1 on, MN2 on. Freewheeling.

Buck-Boost Mode

When `BBstMode = 0` (register 0x01[2]), the regulator operates in buck-boost mode. The inductor charges in Phase 2 up to `BBstIPSet1` (register 0x03[3:0]). The buck-boost then transitions to Phase 1. If $V_{IN} > V_{OUT}$, the inductor continues charging until either the current reaches `BBstIPSet1 + BBstIPSet2` (register 0x03[7:4]) or after a 500ns delay. If $V_{IN} \leq V_{OUT}$, the buck-boost waits for the 500ns timeout to elapse or until the current drops to the valley limit. Next, the regulator enters Phase 3 to discharge the inductor current to the valley limit. When the inductor current reaches the valley-current

crossing threshold or falls below 0, the regulator freewheels in Phase 4 until the next charge phase. When operating in continuous conduction mode (CCM), the buck-boost enters Phase 4 for approximately 30ns if $BBstZCCmpDis = 1$ (register 0x01[4]). The buck-boost skips Phase 4 when operating in CCM and $BBstZCCmpDis = 0$. The valley behavior is determined by $BBstZCCmpDis$. [Figure 2](#) shows the inductor current in buck-boost mode.

Buck-Only Mode

To maximize efficiency when $V_{IN} > V_{OUT}$, the buck-boost regulator has a buck-only mode. When $BBstMode = 1$, the regulator behaves as a synchronously rectified buck regulator. If the device is set to buck-only mode, the regulator never enters Phase 2. Instead, the inductor is always charged in Phase 1. The inductor charges until its current reaches $BBstIPSet1$ or the 500ns timeout elapses. The regulator then transitions to Phase 3 to provide a path to deliver the inductor current to the output. [Figure 3](#) shows the inductor current in buck-only mode.

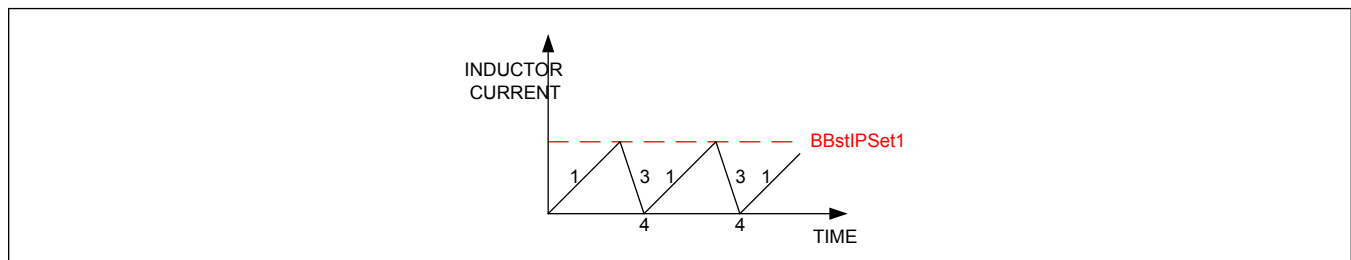

Figure 3. Buck-Boost Inductor Current in Buck-Only Mode

Buck-only mode reduces switching losses present in buck-boost mode. Buck-only mode should be used when V_{OUT} is always less than V_{IN} to maximize efficiency.

Inductor Peak and Valley Current Limits

The buck-boost regulator monitors the maximum and minimum values of the inductor current. If $BBstIPAdptDis = 1$ (register 0x04[1]), the peak currents are fixed to the values in $BBstIPSet$ (register 0x03) and the valley current is fixed to 0mA. If $BBstAdptDis = 0$, the peak and valley currents are allowed to change based on load requirements.

Peak currents are set in the $BBstIPSet$ register. $BBstIPSet1$ controls the peak current when $V_{IN} < V_{OUT}$ and begins the timeout period for Phase 1. $BBstIPSet2$ sets a secondary current limit in buck-boost mode when $V_{IN} > V_{OUT}$. The total inductor current limit when $V_{IN} > V_{OUT}$ is $BBstIPSet1 + BBstIPSet2$. The buck-boost regulator transitions from Phase 1 to Phase 3 if the inductor current reaches $BBstIPSet1 + BBstIPSet2$ or if the 500ns timeout has elapsed. Minimizing the difference between $BBstIPSet1$ and $BBstIPSet2$ reduces the output ripple, but decreases efficiency. Care must be taken to optimize the peak current settings to keep a low output ripple while maximizing efficiency. [Figure 4](#) presents the safe operating area of $BBstIPSet2$ with respect to $BBstIPSet1$. Selecting values outside of the limits shown in [Figure 4](#) can cause unwanted behavior. [Figure 5](#) is a graphical guide to selecting combinations of $BBstIPSet1$ and $BBstIPSet2$ to balance efficiency for specific $BBstVSet$ values.

In order to control inrush current during startup, the MAX20343/MAX20344 forces discontinuous conduction mode during startup (valley current is always 0) and overrides the peak current settings with $BBstIP1SS$ and $BBstIP2SS$. Once the output reaches its final voltage, continuous conduction mode is allowed and the $BBstIPSet1$ and $BBstIPSet2$ settings are restored. See $BBstIP1SS$ and $BBstIP2SS$ ([Table 3](#)) for device-specific values.

The MAX20343/MAX20344 behavior when $BBstIPAdptDis = 0$ can be further defined with a zero current comparator. The device transitions to Phase 4 when its control loop detects a zero current crossing.

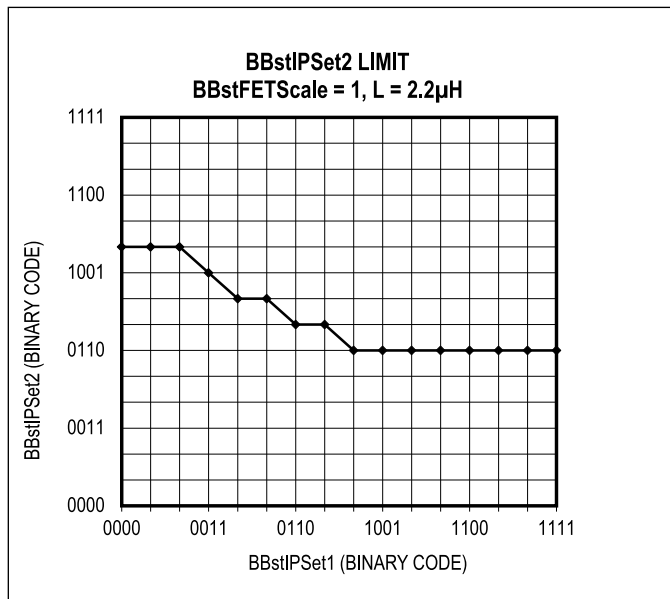

Figure 4. Minimum BBstIPSet2 Limit for Given BBstIPSet1 Setting

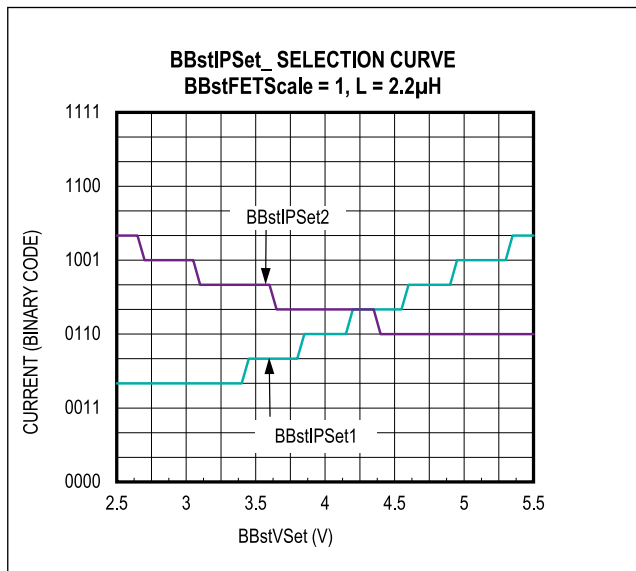

Figure 5. Recommended BBstIPSet1 and BBstIPSet2 Settings

When BBstZCCmpDis = 1 (register 0x01[4]), the zero crossing comparator is disabled and the buck-boost operates with only peak and valley current limits. In this configuration, the valley current limit acts as the zero crossing limit. In DCM, the valley limit is 0mA and is a true zero current crossing. In CCM, the peak and valley limits are automatically adjusted by the adaptive current control, so the effective zero current point might be larger than 0mA. This causes the MAX20343/MAX20344 to briefly enter Phase 4 each time the inductor current reaches the valley current threshold before transitioning to an inductor-charging phase. Setting BBstZCCmpDis = 0 enables the zero current comparator and the buck-boost operates with peak, valley, and zero crossing current limits. While the adaptive current loop adjusts the peak and valley currents, the zero crossing limit is fixed at 0mA. In DCM, the regulator functions similarly to when BBstZCCmpDis = 1. However, in CCM, the valley current is greater than the zero crossing current, so the regulator bypasses Phase 4 and directly enters an inductor-charging phase when the inductor current reaches the valley current threshold.

Disabling the zero current crossing comparator reduces the buck-boost output ripple. Enabling the comparator improves efficiency in CCM by removing the Phase 4 stage in CCM that is otherwise present when BBstZCCmpDis = 1.

Integrator Control Loop Disable

The MAX20343/MAX20344 contains an integrator in its control loop for normal operation. This integrator improves the load regulation for larger loads, but increases the transient response time. For applications where the output must quickly settle to a final regulation value to prevent noise injection during sensitive measurements (such as in PPG measurements), the integrator can be disabled so the regulator operates with a proportional-only control loop. The BBstIntegEn bit (register 0x04[2]) enables and disables the integrator to speed response time on load transients (integrator off) or to increase the load capacity (integrator on). Note that when the integrator is disabled output stability is only guaranteed up to the maximum output power for input voltages down to 2.5V. To operate at lower input voltages, the output capacitance must be increased.

Input Operating Voltage

Operating at low input voltages enables a system to extract as much energy as possible from its energy source before shutting down. After startup and with SwoFrIn = 0, and $V_{OUT} \geq 3.2V$, the MAX20343/MAX20344 can operate to very low input voltages limited only by the amount of current that can be drawn effectively from the input. This allows a system to run the MAX20343/MAX20344 well below the minimum startup voltage, albeit at a reduced power capability.

When the input voltage is low, the R_{ON} of the input p-channel MOSFET increases. To offset the inherent increase in resistance, an n-channel MOSFET is present in parallel with the input MOSFET. The n-channel MOSFET is only enabled when the input voltage falls below $V_{IN_UVLO_F}$ to reduce switching losses at higher input voltages. In order to provide sufficient overdrive for the n-channel device, it is necessary to keep $V_{OUT} \geq 3.2V$. Therefore, high power operation below $V_{IN_UVLO_F}$ is only guaranteed if the output voltage is set to 3.2V or above.

Output Operating Power and Other Optimizations

The MAX20343/MAX20344 is a highly flexible device with many operating modes that allows the user to optimize the performance for their application. For applications like driving an LED for on the wrist PPG, settling time to a steady-state voltage during a load transient is critical. In such cases, the user benefits from a proportional-only output response ($BBstIntegEn = 0$, disabled), which trades an increased steady-state load regulation error for speed of settling. On the other hand, some applications are not as sensitive to response time, but benefit from the lower steady-state load regulation error provided when the integrator is enabled ($BBstIntegEn = 1$, enabled).

The efficiency can also be optimized by selecting the $BBstFETScale$ setting according to which load region should be the focus for efficiency. If the application should primarily be optimized for light-load efficiency, the $BBstFETScale = 1$ (enabled) setting is preferable and vice-versa. Note that the improvement in efficiency at light loads with $BBstFETScale = 1$ comes with the tradeoff of lower maximum output power, which should be a consideration when configuring the setting. A comparison of performances for each setting can be found in the [Typical Operating Characteristics](#) section.

Finally, the MAX20343/MAX20344 features an internal switchover circuit (configured by $SwoFrcIN$), which manages the supply from which the internal circuitry of the buck-boost is driven. For applications where quiescent current is important and the primary operating mode is to boost the output, the switchover should be forced to the input ($SwoFrcIN = 1$). This is because the quiescent current when $SwoFrcIN = 0$ is drawn from the output, meaning that the input current is increased by the boost ratio and the efficiency of the conversion. However, in cases where a low input operating voltage must be supported, the $SwoFrcIN = 0$ setting allows the input voltage to drop much lower since the output voltage can be used to enhance the switching FETs of the buck-boost, keeping the on-resistance low. Note that when $SwoFrcIN = 1$, the buck-boost output automatically shuts down when V_{IN} falls below $V_{IN_UVLO_F}$ (1.782V typ). Instead when $SwoFrcIN = 0$ and $V_{OUT} \geq 3.2V$, the output continues to run even when V_{IN} falls very low and is only disabled when the output voltage falls below $V_{OUT_UVLO_F}$ or when the user disables the device. In this operating mode, the output power capabilities begin to decrease as the input voltage falls. To indicate that the input voltage has fallen to a critical level, the device generates an IN_UVLO status and interrupt for the system, which means that V_{IN} has dropped below $V_{IN_UVLO_F}$ and the source might be in a critical state. A comparison of performances for each setting can be found in the [Typical Operating Characteristics](#) section. For each combination of the above settings, there are tradeoffs to consider. [Table 2](#) below gives a general outline of the basic characteristics to expect with a given configuration.

Device Control

I²C-Controlled

The I²C-controlled versions of MAX20343/MAX20344 enable system flexibility by providing an interface between the device and a host microcontroller. Different parameters of the regulator, such as output voltage the inductor peak current levels, FET scaling, etc., can be optimized in real time for any application. While default values are programmed by the factory, new values can be set in the I²C registers. For device versions with I²C control take special care to observe the default setting of $BBstEn$ in [Table 3](#). Versions with $BBstEn =$ disabled by default need to have another power supply present that allows the system to wake the buck-boost by I²C command. In versions of the MAX20343/MAX20344 with an I²C interface and an RSEL voltage selection pin, the default voltage selected by the RSEL resistor can be overwritten over I²C after the OutGood (register 0x05[1]) status goes high.

The full configuration settings and status information provided through this interface are detailed in the register descriptions. The slave address information for I²C-controlled versions of MAX20343/MAX20344 can be found in the [Applications Information](#) section.

Single-Pin-Enabled

In the single-pin-enabled, fixed-programming versions of MAX20343/MAX20344, all configuration settings excluding the output voltage are programmed by the factory and cannot be modified in an application. Setting EN high turns on the buck-boost output and setting EN low turns off the buck-boost output. The BBstEn bit is ineffective in the Single-Pin-Enabled version. Two status pins, INGOOD and PGOOD, signal that the input and output voltages are ready to support the full system power requirements, respectively.

When the FAST/RSEL pin of a single-pin-enabled MAX20343/MAX20344 is configured to RSEL, the output voltage is set by the the RSEL resistor at startup. When the FAST/RSEL pin is configured to FAST, the output voltage is set by the factory.

Dynamic Voltage Scaling (DVS)

The output voltage of I²C-controlled MAX20343/MAX20344 devices can be changed at any point while the device is enabled without restarting the device. This feature is known as dynamic voltage scaling. DVS enables systems to operate at different voltage rails when the voltage or power requirements of the system change in different operating modes. By decreasing the voltage to the minimum value required by an operating mode, the overall system efficiency increases. The output voltage is set in BBstVSet[5:0] (register 0x02[5:0]).

RSEL Voltage Setting

RSEL is a unique, single-resistor output voltage selection method that minimizes quiescent current. Once power is applied at V_{IN} and the enable pin is brought high, the MAX20343/MAX20344 starts up and regulates to the minimum programmable voltage (2.5V). Once an internal PGOOD signal indicates that the voltage has reached an acceptable level, the device begins drawing up to 200 μ A from V_{IN} in order to read the resistor value on RSEL. This current is only present during the RSEL resistor detection time, typically 750 μ s. After the detection and output voltage programming period, the output increases to the set value. The output rise time is determined by the BBstRampEn setting. [Figure 6](#) illustrates this startup sequence.

RSEL has many benefits, including lower cost and smaller size. Only one resistor is needed versus the two resistors required in typical feedback connections. Another benefit of RSEL is that one regulator can be used in multiple projects with different output voltages just by changing a single standard 1% resistor. Lastly, RSEL eliminates wasting current continuously through feedback resistors for ultra-low power, battery-operated products. Select the RSEL resistor value by choosing the desired output voltage in [Table 1](#). Leaving RSEL open sets the output to the default voltage of the device (see [Table 3](#) for device configurations).

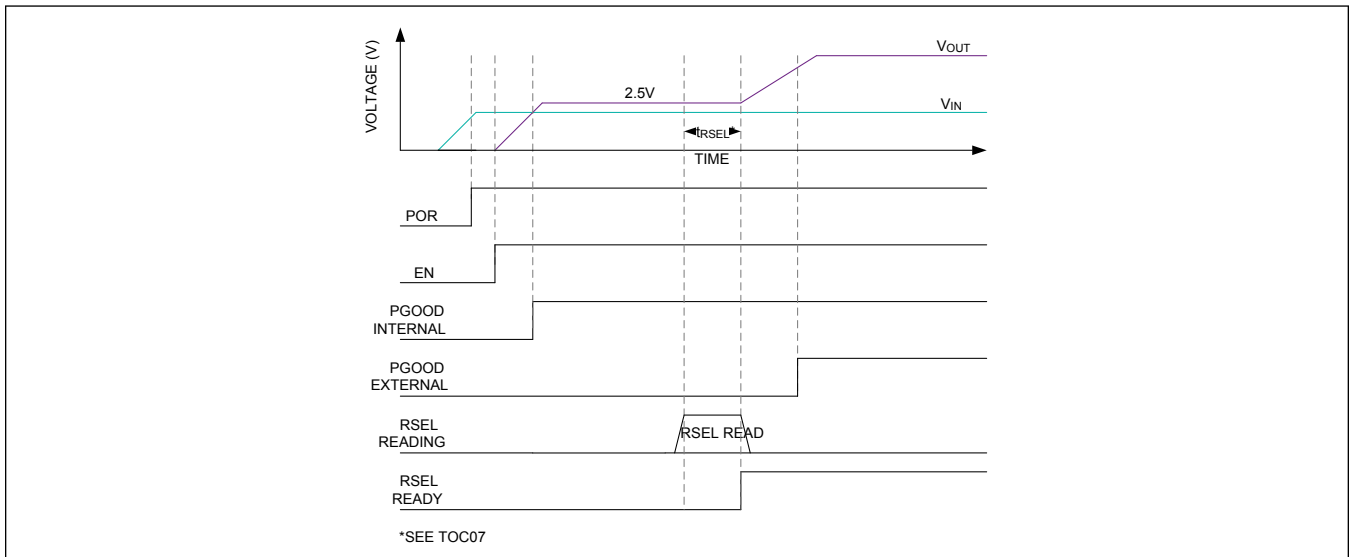

Figure 6. MAX20343/MAX20344 RSEL Startup Sequence

Table 1. RSEL SELECTION TABLE

OUTPUT VOLTAGE (V)	STD RES 1% (kΩ)
Default	OPEN
2.5	590
2.7	422
3.0	301
3.2	210
3.3	150
3.4	105
3.5	75
3.6	53.6
3.7	37.4
3.8	26.7
4.0	18.7
4.2	13.3
4.5	9.31
5.0	6.65
5.5	SHORT

Table 2. Characteristics and Device Settings

CHARACTERISTICS					DEVICE SETTINGS		
MAX OUTPUT POWER ($V_{IN} = V_{OUT} \geq 3.2V$) (W)	QUIESCENT CURRENT	OPTIMIZED FOR: STEADY- STATE LOAD REGULATION ERROR OR LOAD-TRANSIENT SETTLING TIME	EFFICIENCY OPTIMIZED CURRENT RANGE	INPUT OPERATING VOLTAGE < $V_{IN_UVLO_F}$	BBSTFETSCALE	BBSTINTEGEN	SWOFRGIN
≥ 3.2	INCREASED IN BOOST MODE	SETTLING TIME	HIGH	YES ($V_{OUT} \geq 3.2V$)	0	0	0
≥ 3.2	LOWEST	SETTLING TIME	HIGH	NO	0	0	1
≥ 3.5	INCREASED IN BOOST MODE	LOAD REGULATION	HIGH	YES ($V_{OUT} \geq 3.2V$)	0	1	0
≥ 3.5	LOWEST	LOAD REGULATION	HIGH	NO	0	1	1
≥ 1.75	INCREASED IN BOOST MODE	SETTLING TIME	LOW/ MEDIUM	YES ($V_{OUT} \geq 3.2V$)	1	0	0
≥ 1.75	LOWEST	SETTLING TIME	LOW/ MEDIUM	NO	1	0	1
≥ 1.75	INCREASED IN BOOST MODE	LOAD REGULATION	LOW/ MEDIUM	YES ($V_{OUT} \geq 3.2V$)	1	1	0
≥ 1.75	LOWEST	LOAD REGULATION	LOW/ MEDIUM	NO	1	1	1

Register Map

MAX20343/MAX20344

ADDRESS	NAME	MSB							LSB
USER									
0x00	ChipID[7:0]	ChipID[7:0]							
0x01	BBstCfg0[7:0]	BBstEn	BBstRampEn	BBstFast	BBstZCCmpDis	BBstLowEMI	BBstMode	BBstActDsc	BBstPsvDsc
0x02	BBstVSet[7:0]	BBFHighSh[1:0]		BBstVSet[5:0]					
0x03	BBstISet[7:0]	BBstIPSet2[3:0]				BBstIPSet1[3:0]			
0x04	BBstCfg1[7:0]	FstCmpEn	PasThrMode	SwoFrclN	–	–	BBstIntegEn	BBstIPAdptDis	BBstFETScale
0x05	Status[7:0]	–	–	–	–	–	–	OutGood	InUVLO
0x06	Int[7:0]	–	–	–	–	–	–	OutGoodInt	InUVLOInt
0x07	Mask[7:0]	–	–	–	–	–	–	OutGoodIntM	InUVLOIntM
0x50	LockMsk[7:0]	–	–	–	–	–	–	–	BBLck
0x51	LockUnlock[7:0]	PASSWD[7:0]							

Register Details

[ChipID \(0x00\)](#)

BIT	7	6	5	4	3	2	1	0
Field	ChipID[7:0]							
Reset								
Access Type	Read Only							

BITFIELD	BITS	DESCRIPTION
ChipID	7:0	ChipID[7:0] indicates the version of the device in use.

[BBstCfg0 \(0x01\)](#)

BIT	7	6	5	4	3	2	1	0
Field	BBstEn	BBstRampEn	BBstFast	BBstZCCmpDis	BBstLowEMI	BBstMode	BBstActDsc	BBstPsvDsc
Reset								
Access Type	Write, Read	Write, Read	Write, Read	Write, Read	Write, Read	Write, Read	Write, Read	Write, Read

BITFIELD	BITS	DESCRIPTION
BBstEn	7	Buck-Boost Enable 0 = Buck-boost disabled 1 = Buck-boost enabled

BITFIELD	BITS	DESCRIPTION
BBstRampEn	6	Buck-Boost Ramp Enable 0 = Output voltage setting transition is performed without intermediate steps 1 = Output voltage setting increases are performed with a digital ramp of 50mV every 50µs
BBstFast	5	Buck-Boost Pretrigger Mode Setting Increases the quiescent current of the buck-boost to improve output regulation during load transients. 0 = Normal, low quiescent current operation 1 = Fast response mode enabled. Quiescent current increased to 35µA (typ).
BBstZCCmpDis	4	Buck-Boost Zero-Crossing Comparator Disable. Latched internally, it can only be changed when BBstEn = 0 0 = Enabled 1 = Disabled
BBstLowEMI	3	Buck-Boost Low EMI Mode Increases the rise/fall time of HVLX/LVLX to reduce EMI, at the cost of efficiency. 0 = Normal operation 1 = Increase rise/fall time on HVLX/LVLX by 3x
BBstMode	2	Buck-Boost Operating Mode Configures the regulator to operate in buck-boost or buck-only mode. Latched internally, can only be changed while BBstEn = 0. 0 = Buck-boost mode 1 = Buck-only mode
BBstActDsc	1	Buck-Boost Active Discharge Control 0 = Buck-boost not actively discharged 1 = Buck-boost actively discharged on shutdown
BBstPsvDsc	0	Buck-Boost Passive Discharge Control 0 = Buck-boost not passively discharged 1 = Buck-boost passively discharged on shutdown

BBstVSet (0x02)

BIT	7	6	5	4	3	2	1	0
Field	BBFHighSh[1:0]		BBstVSet[5:0]					
Reset								
Access Type	Write, Read		Write, Read					

BITFIELD	BITS	DESCRIPTION
BBFHighSh	7:6	Buck-Boost f_{HIGH} Thresholds Selects the switching frequency threshold f_{HIGH} . If the buck-boost switching frequency exceeds the f_{HIGH} rising threshold, all the blocks are kept ON (I_Q is higher) until the frequency reaches the f_{HIGH} falling threshold. A small glitch on V_{OUT} can be present at the f_{HIGH} crossover. 00 = 25kHz rising / 6.125kHz falling 01 = 35kHz rising / 8.25kHz falling 10 = 50kHz rising / 12.5kHz falling 11 = 100kHz rising / 25kHz falling
BBstVSet	5:0	Buck-Boost Output Voltage Setting 2.5V to 5.5V, Linear Scale, 50mV increments 000000 = 2.5V 000001 = 2.55V ... ≥111100 = 5.5V

BBstIPSet (0x03)

BIT	7	6	5	4	3	2	1	0
Field	BBstIPSet2[3:0]				BBstIPSet1[3:0]			
Reset								
Access Type	Write, Read				Write, Read			

BITFIELD	BITS	DESCRIPTION
BBstIPSet2	7:4	<p>Buck-Boost Nominal Maximum Peak Current Setting See buck-boost operation section for a description of the peak current settings. 0mA (minimum t_{ON}) to 618.75mA, linear scale, 41.25mA increments for BBstFETScale = 0. 0mA (minimum t_{ON}) to 375mA, linear scale, 25mA increments for BBstFETScale = 1.</p> <p>BBstFETScale = 0: 0000 = 0mA (minimum t_{ON}) 0001 = 50mA ... 1111 = 750mA</p> <p>Recommended settings $V_{OUT} \leq 2.65V$: 500mA(1010) $2.65V < V_{OUT} \leq 3.05V$: 450mA(1001) $3.05V < V_{OUT} \leq 3.60V$: 400mA(1000) $3.60V < V_{OUT} \leq 4.35V$: 350mA(0111) $V_{OUT} > 4.35V$: 300mA(0110)</p> <p>BBstFETScale = 1: 0000 = 0mA (minimum t_{ON}) 0001 = 25mA ... 1111 = 375mA</p> <p>Recommended settings $V_{OUT} \leq 2.65V$: 250mA(1010) $2.65V < V_{OUT} \leq 3.05V$: 225mA(1001) $3.05V < V_{OUT} \leq 3.60V$: 200mA(1000) $3.60V < V_{OUT} \leq 4.35V$: 175mA(0111) $V_{OUT} > 4.35V$: 150mA(0110)</p>

BITFIELD	BITS	DESCRIPTION
BBstIPSet1	3:0	<p>Buck-boost nominal peak current setting 1 Nominal peak current when charging inductor between V_{IN} and GND. See buck-boost operation section for a description of the peak current settings. 0mA (minimum t_{ON}) to 618.75mA, linear scale, 41.25mA increments for BBstFETScale = 0. 0mA (minimum t_{ON}) to 375mA, linear scale, 25mA increments for BBstFETScale = 1.</p> <p>BBstFETScale = 0: 0000 = 0mA (minimum t_{ON}) 0001 = 50mA ... 1111 = 750mA Recommended settings $V_{OUT} \leq 3.40V$: 200mA $3.40V < V_{OUT} \leq 3.80V$: 250mA(0101) $3.80V < V_{OUT} \leq 4.15V$: 300mA(0110) $4.15V < V_{OUT} \leq 4.55V$: 350mA(0111) $4.55V < V_{OUT} \leq 4.90V$: 400mA(1000) $4.90V < V_{OUT} \leq 5.30V$: 450mA(1001) $V_{OUT} > 5.30V$: 500mA(1010) BBstFETScale = 1: 0000 = 0mA (minimum t_{ON}) 0001 = 25mA ... 1111 = 375mA Recommended settings $V_{OUT} \leq 3.40V$: 100mA(0100) $3.40V < V_{OUT} \leq 3.80V$: 125mA(0101) $3.80V < V_{OUT} \leq 4.15V$: 150mA(0110) $4.20V < V_{OUT} \leq 4.55V$: 175mA(0111) $4.60V < V_{OUT} \leq 4.90V$: 200mA(1000) $4.95V < V_{OUT} \leq 5.30V$: 225mA(1001) $V_{OUT} > 5.30V$: 250mA(1010)</p>

BBstCfg1 (0x04)

BIT	7	6	5	4	3	2	1	0
Field	FstCmpEn	PasThrMode	SwoFrcIN	-	-	BBstIntegEn	BBstIPAdptDis	BBstFETScale
Reset				-	-			
Access Type	Write, Read	Write, Read	Write, Read	-	-	Write, Read	Write, Read	Write, Read

BITFIELD	BITS	DESCRIPTION
FstCmpEn	7	<p>FAST Comparator Enable The FAST mode comparator is enabled by the logical AND of the FAST pin and FstCmpEn. 0 = FAST pin does not control FAST mode 1 = FAST pin can set the device into FAST mode</p>
PasThrMode	6	<p>Pass Through Mode Bypasses the regulator to connect V_{OUT} to V_{IN}. This can only be enabled when BBstEn = 0 (register 0x01). 0 = Pass Through Mode disabled 1 = Pass Through Mode enabled. Enable only when BBstEn = 0.</p>

BITFIELD	BITS	DESCRIPTION
SwoFrcIN	5	Force Switch-Over Controls how the device powers the internal circuitry. 0 = Switch-over supply forced to V_{OUT} when $V_{OUT} > V_{OUT_UVLO_R}$. 1 = Switch-over supply forced to V_{IN} .
BBstIntegEn	2	Buck-Boost Integrator Enable The Integrator can be disabled to improve settling time on load transients at the cost of load regulation error. Latched internally, it can only be changed when BBstEn = 0. 0 = Integrator disabled 1 = Integrator enabled
BBstIPAdptDis	1	Adaptive Peak/Valley Current Adjustment Disable 0 = Enabled 1 = Disabled, peak current fixed to the values set by BBstIPSet1 and BBstIPSet2. Valley current is fixed to 0mA. This setting is equivalent to forcing discontinuous conduction mode and greatly diminishes the output power capability of the part. Generally this is not a recommended setting.
BBstFETScale	0	FET Scale Reduces FET sizes by a factor of 2. This setting can be used to optimize efficiency for lighter loads if it is acceptable to support lower maximum output power. If BBstFETScale = 0, the part requires a 1 μ H inductor and at least twice the derated capacitance in Figure 9. If BBstFETScale = 1, the part requires a 2.2 μ H inductor and at least the derated capacitance in Figure 9. Latched internally, it can only be changed when BBstEn = 0. 0 = FET scaling disabled 1 = FET scaling enabled

Status (0x05)

BIT	7	6	5	4	3	2	1	0
Field	–	–	–	–	–	–	OutGood	InUVLO
Reset	–	–	–	–	–	–		
Access Type	–	–	–	–	–	–	Read Only	Read Only

BITFIELD	BITS	DESCRIPTION
OutGood	1	Status of Output Voltage 0 = Output has not reached full power capability 1 = Output voltage is high enough to support full power capability
InUVLO	0	Status register showing whether input voltage is low enough to enable parallel input NMOS. 0 = V_{IN} high enough for full power operation 1 = Power may be limited due to low V_{IN}

Int (0x06)

BIT	7	6	5	4	3	2	1	0
Field	–	–	–	–	–	–	OutGoodInt	InUVLOInt
Reset	–	–	–	–	–	–		
Access Type	–	–	–	–	–	–	Read Only	Read Only

BITFIELD	BITS	DESCRIPTION
OutGoodInt	1	Change in OutGood caused an interrupt
InUVLOInt	0	Change in InUVLO caused an interrupt

Mask (0x07)

BIT	7	6	5	4	3	2	1	0
Field	–	–	–	–	–	–	OutGoodInt M	InUVLOIntM
Reset	–	–	–	–	–	–		
Access Type	–	–	–	–	–	–	Write, Read	Write, Read

BITFIELD	BITS	DESCRIPTION
OutGoodIntM	1	OutGoodIntM masks the OutGoodInt interrupt. 0 = Not masked 1 = Masked
InUVLOIntM	0	InUVLOIntM masks the InUVLOInt interrupt. 0 = Not masked 1 = Masked

LockMsk (0x50)

BIT	7	6	5	4	3	2	1	0
Field	–	–	–	–	–	–	–	BBLck
Reset	–	–	–	–	–	–	–	0x1
Access Type	–	–	–	–	–	–	–	Write, Read

BITFIELD	BITS	DESCRIPTION
BBLck	0	Lock Mask for Buck-Boost Registers 0 = Buck-Boost Registers not masked from locking/unlocking 1 = Buck-Boost Registers masked from locking/unlocking

LockUnlock (0x51)

BIT	7	6	5	4	3	2	1	0
Field	PASSWD[7:0]							
Reset	0xFF							
Access Type	Write, Read							

BITFIELD	BITS	DESCRIPTION
PASSWD	7:0	Lock/Unlock Password Write 0xAA with BBLck unmasked to lock the BBstVSet[5:0] field Write 0x55 with BBLck unmasked to unlock the BBstVSet[5:0] field

Applications Information

Input and Output Capacitance

The MAX20343/MAX20344 is designed to be compatible with small case-size ceramic capacitors. As such, the device has low-input and low-output capacitance requirements to accommodate the steep voltage derating of 0603 and 0402 (imperial) capacitors. The sample derating curve for a 22 μ F nominal value capacitor in [Figure 7](#) presents the minimum capacitance required at IN and OUT. To ensure stability and low noise, the capacitance value under bias on IN should be the minimum of 5 μ F and the value of [Figure 7](#) at the lowest expected V_{IN} . The minimum capacitance value under bias on OUT should be equal to the value of [Figure 7](#) at the lowest expected V_{OUT} for BBstFETScale = 1 and twice that value for BBstFETScale = 0. Note that the derating curve in [Figure 7](#) is a sample only, refer to the manufacturer's derating curve of the actual capacitor selected to ensure that the minimum capacitance values under bias are met.

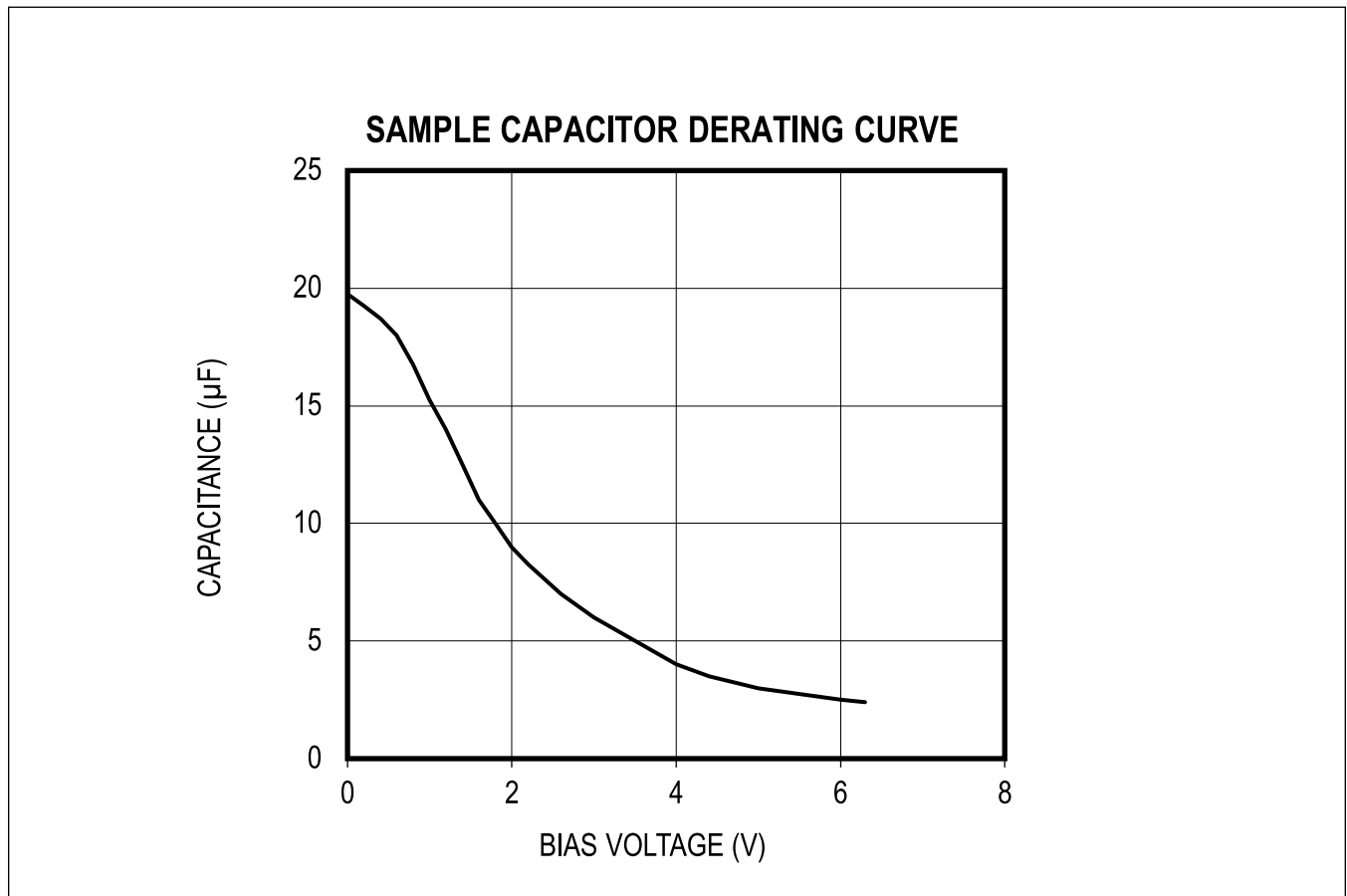

Figure 7. Buck-Boost Required Minimum Input/Output Capacitance

Inductor Selection

Inductor selection for the MAX20343/MAX20344 should be optimized for the intended application. A 2.2µH inductor value is required when FET scaling is enabled (BBstFETScale = 1) while 1µH is required when FET scaling is disabled (BBstFETScale = 0). Aside from the inductor value physical size, DC resistance (DCR), maximum average current, and saturation current are the primary factors to consider. The maximum average inductor current is obtained using the following equation:

$$I_{L_MAX} = \frac{V_{OUT_MAX} \times I_{OUT_MAX}}{\eta \times V_{IN_MIN}}$$

Where,

V_{OUT_MAX} is the maximum expected operating voltage,

I_{OUT_MAX} is the maximum expected output current,

V_{IN_MIN} is the minimum expected operating input voltage,

η is the expected worst case efficiency in the minimum input voltage and maximum output power case (see the [Typical Operating Characteristics](#) for help in estimating efficiency).

The average inductor current calculated above dictates the required maximum average current for temperature rise on the inductor. In order to determine the required inductor saturation current, the peak current must be calculated. The peak current for this converter can be calculated as:

$$I_{L_PEAK} = I_{L_MAX} + (1.1 \times \text{BBstIPSet1})$$

Where BBstIPSet1 is the peak current setting described in register 0x03. When selecting an inductor, one primary factor in achieving high efficiency is the DCR of the inductor. For maximum efficiency, select an inductor with the lowest DCR possible in the required package size. Another factor to consider is magnetic losses. Generally magnetic losses are lower in inductors with larger physical size and/or higher saturation current ratings. In most cases ferrite inductors should be avoided as they tend to exhibit poor AC characteristics especially in discontinuous conduction mode (DCM).

Soft-Start

Current at startup is limited by forcing DCM. This allows startup of the system with input voltages down to 1.9V.

I²C Interface

The MAX20343/MAX20344 contains an I²C-compatible interface for data communication with a host controller (SCL and SDA). The MAX20343/MAX20344 can support I²C frequencies from 0kHz to 680kHz. SCL and SDA require pullup resistors that are connected to a positive supply.

Slave Address

In the MAX20343/MAX20344, the slave address is configured at the factory by the SlaveAddr bit to be either 0b1101000 (0x68) plus the Read/Write bit or 0b1101100 (0x6C) plus the Read/Write bit. For versions with the 7-bit slave address 0x68 Set the Read/Write bit high to configure the MAX20343 to read mode (0xD1) or set the Read/Write bit low to configure the MAX20343/MAX20344 to write mode (0xD0). For versions with the 7-bit slave address 0x6C Set the Read/Write bit high to configure the MAX20343/MAX20344 to read mode (0xD8) or set the Read/Write bit low to configure the MAX20343/MAX20344 to write mode (0xD9). See SlaveAddr in [Table 3](#) for the slave address for a given part number. The address is the first byte of information sent to the MAX20343/MAX20344 after the START condition.

Start, Stop, and Repeated Start Conditions

When writing to the MAX20343/MAX20344 using I²C, the master sends a START condition (S) followed by the MAX20343/MAX20344 I²C write address. After the address, the master sends the register address of the register that is to be programmed. The master then ends communication by issuing a STOP condition (P) to relinquish control of the bus, or a REPEATED START condition (Sr) to communicate to another I²C slave. See [Figure 8](#).

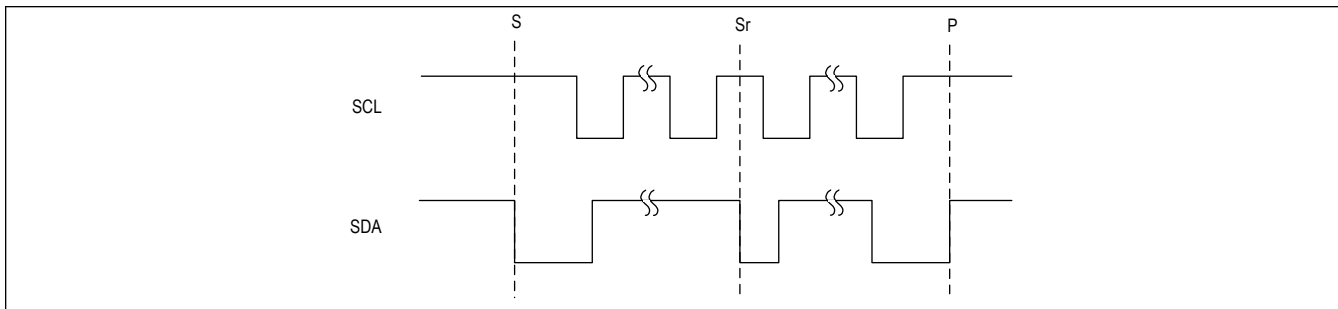

Figure 8. I²C START, STOP, and REPEATED START Conditions

Bit Transfer

One data bit is transferred on the rising edge of each SCL clock cycle. The data on SDA must remain stable during the high period of the SCL clock pulse. Changes in SDA while SCL is high and stable are considered control signals (see the [Start, Stop, and Repeated Start Conditions](#) section). Both SDA and SCL remain high when the bus is not active.

Single-Byte Write

In this operation, the master sends an address and two data bytes to the slave device (Figure 9). The following procedure describes the single byte write operation:

- The master sends a START condition.
- The master sends the 7-bit slave address plus a write bit (low).
- The addressed slave asserts an ACK on the data line.
- The master sends the 8-bit register address.
- The slave asserts an ACK on the data line only if the address is valid (NACK if not).
- The master sends 8 data bits.
- The slave asserts an ACK on the data line.
- The master generates a STOP condition.

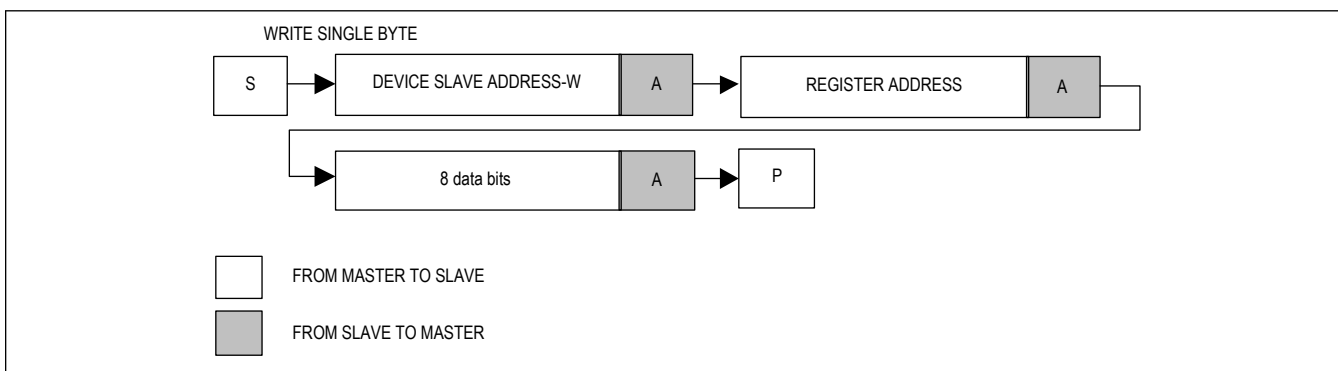

Figure 9. Write Byte Sequence

Burst Write

In this operation, the master sends an address and multiple data bytes to the slave device (Figure 10). The slave device automatically increments the register address after each data byte is sent, unless the register being accessed is 0x00, in which case the register address remains the same. The following procedure describes the burst write operation:

- The master sends a START condition.
- The master sends the 7-bit slave address plus a write bit (low).
- The addressed slave asserts an ACK on the data line.
- The master sends the 8-bit register address.
- The slave asserts an ACK on the data line only if the address is valid (NACK if not).

- The master sends 8 data bits.
- The slave asserts an ACK on the data line.
- Repeat 6 and 7 N-1 times.
- The master generates a STOP condition.

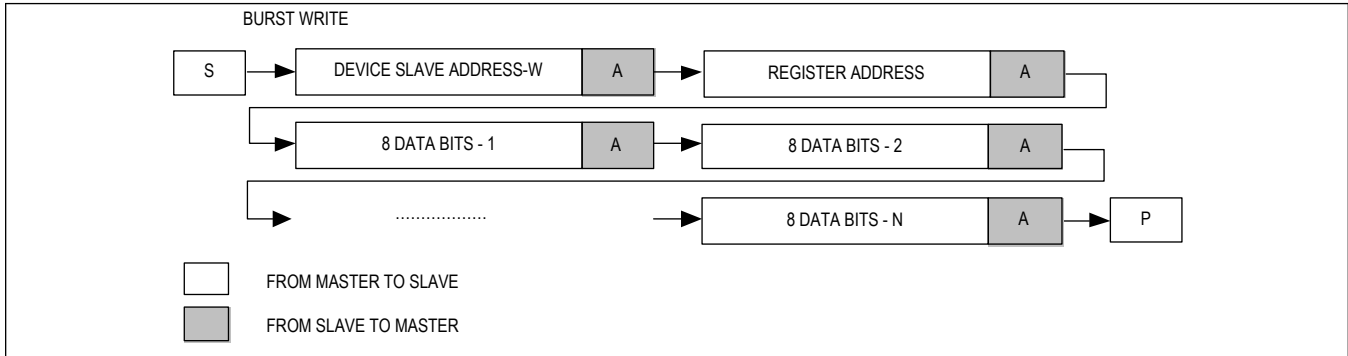

Figure 10. Burst Write Sequence

Single Byte Read

In this operation, the master sends an address plus two data bytes and receives one data byte from the slave device (Figure 11). The following procedure describes the single byte read operation:

- The master sends a START condition.
- The master sends the 7-bit slave address plus a write bit (low).
- The addressed slave asserts an ACK on the data line.
- The master sends the 8-bit register address.
- The slave asserts an ACK on the data line only if the address is valid (NACK if not).
- The master sends a REPEATED START condition.
- The master sends the 7-bit slave address plus a read bit (high).
- The addressed slave asserts an ACK on the data line.
- The slave sends 8 data bits.
- The master asserts a NACK on the data line.
- The master generates a STOP condition.

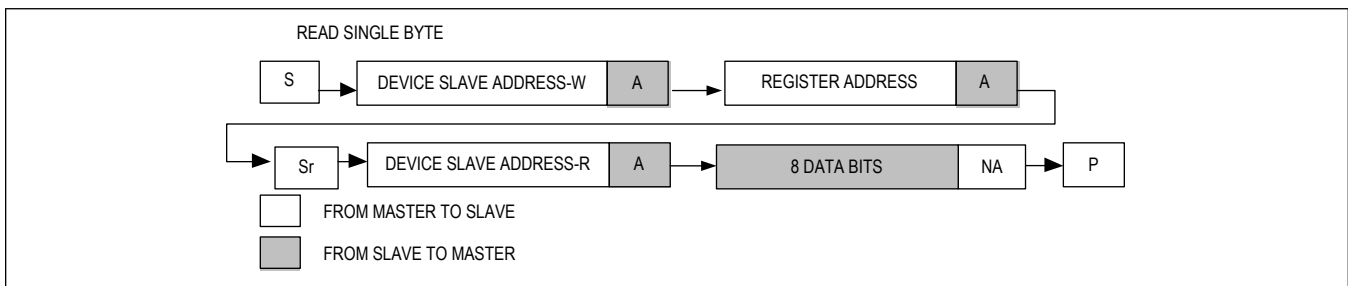

Figure 11. Read Byte Sequence

Burst Read

In this operation, the master sends an address plus two data bytes and receives multiple data bytes from the slave device (Figure 12). The following procedure describes the burst byte read operation:

- The master sends a START condition.
- The master sends the 7-bit slave address plus a write bit (low).
- The addressed slave asserts an ACK on the data line.
- The master sends the 8-bit register address.

- The slave asserts an ACK on the data line only if the address is valid (NACK if not).
- The master sends a REPEATED START condition.
- The master sends the 7-bit slave address plus a read bit (high).
- The slave asserts an ACK on the data line.
- The slave sends 8 data bits.
- The master asserts an ACK on the data line.
- Repeat 9 and 10 N-2 times.
- The slave sends the last 8 data bits.
- The master asserts a NACK on the data line.
- The master generates a STOP condition.

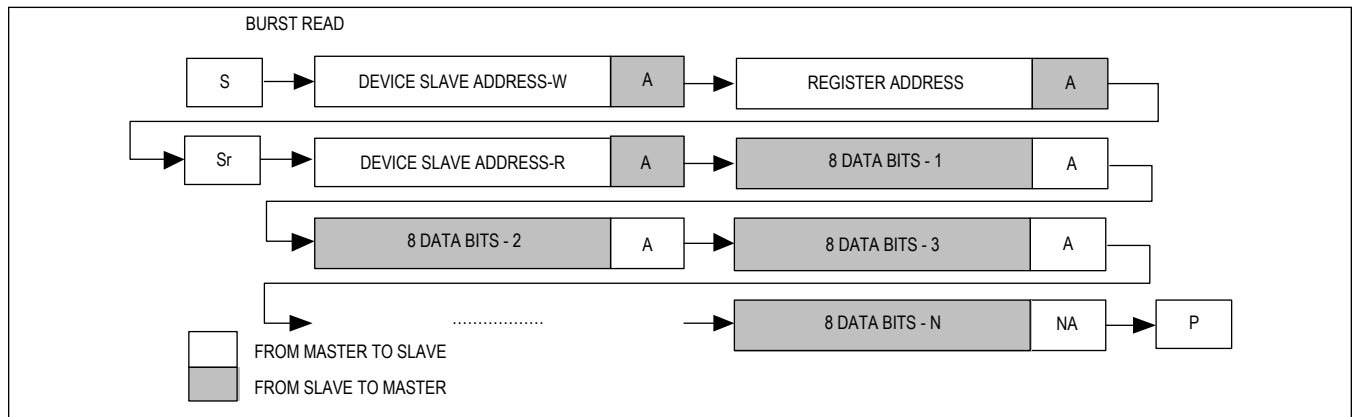

Figure 12. Burst Read Sequence

Acknowledge Bits

Data transfers are acknowledged with an acknowledge bit (ACK) or a not-acknowledge bit (NACK). Both the master and the MAX20343/MAX20344 generate ACK bits. To generate an ACK, pull SDA low before the rising edge of the ninth clock pulse and hold it low during the high period of the ninth clock pulse (Figure 13). To generate a NACK, leave SDA high before the rising edge of the ninth clock pulse and leave it high for the duration of the ninth clock pulse. Monitoring for NACK bits allows for detection of unsuccessful data transfers.

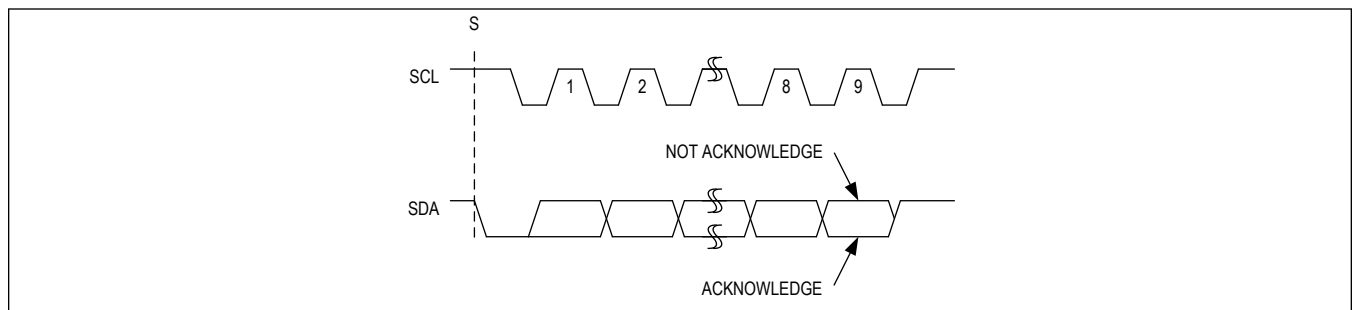

Figure 13. Acknowledge Bits

Register Values

The following tables provide the device and register bit default values for the various available parts.

Table 3. Register Bit Default Values

REGISTER BITS	DEVICE							
	MAX20343B	MAX20343E/ MAX20344E	MAX20343F	MAX20343G/ MAX20343K	MAX20343H	MAX20343I	MAX20343J	MAX20343N
BBstEn	Disabled	Disabled	Enabled	Disabled	Disabled	Disabled	Disabled	Enabled
BBstRampEn	Single Step	Single Step	Single Step	Single Step	Single Step	Single Step	Single Step	Single Step
BBstFast	Low I _Q Mode	Low I _Q Mode	Low I _Q Mode	Low I _Q Mode	Low I _Q Mode	Low I _Q Mode	Low I _Q Mode	Low I _Q Mode
BBstZCCmpDis	ZCC Disabled	ZCC Disabled	ZCC Disabled	ZCC Disabled	ZCC Disabled	ZCC Disabled	ZCC Disabled	ZCC Disabled
BBstLowEMI	High Efficiency	High Efficiency	High Efficiency	High Efficiency	High Efficiency	High Efficiency	High Efficiency	High Efficiency
BBstMode	Buck-Boost	Buck-Boost	Buck-Boost	Buck-Boost	Buck-Boost	Buck-Boost	Buck-Boost	Buck-Boost
BBstActDsc	Active Discharge on Shutdown (50ms)	Active Discharge on Shutdown (50ms)	Active Discharge on Shutdown (50ms)	Active Discharge on Shutdown (50ms)	Active Discharge on Shutdown (50ms)	Active Discharge on Shutdown (50ms)	Active Discharge on Shutdown (50ms)	Active Discharge on Shutdown (50ms)
BBstPsvDsc	Passive Discharge in Shutdown	Passive Discharge in Shutdown	Passive Discharge in Shutdown	Passive Discharge in Shutdown	Passive Discharge in Shutdown	No Passive Discharge	Passive Discharge in Shutdown	Passive Discharge in Shutdown
BBstFHighSh	100kHz/ 25kHz	100kHz/ 25kHz	100kHz/ 25kHz	100kHz/ 25kHz	100kHz/ 25kHz	100kHz/ 25kHz	100kHz/ 25kHz	100kHz/ 25kHz
SwoFrcIn	Switch-Over Forced to V _{OUT} when OutGood = 1	Switch-Over Forced to V _{IN}	Switch-Over Forced to V _{OUT} when OutGood = 1	Switch-Over Forced to V _{OUT} when OutGood = 1	Switch-Over Forced to V _{OUT} when OutGood = 1	Switch-Over Forced to V _{OUT} when OutGood = 1	Switch-Over Forced to V _{IN}	Switch-Over Forced to V _{IN}
BBstVSet[5:0]	3.20V	5.00V	3.30V	3.20V	3.30V	4V	2.85V	5.00V
BBstIntegEn	Disable Integrator	Disable Integrator	Enable Integrator	Disable Integrator	Enable Integrator	Enable Integrator	Disable Integrator	Disable Integrator
BBstIPAdptDis	Adaptive Peak Current Enabled	Adaptive Peak Current Enabled	Adaptive Peak Current Enabled	Adaptive Peak Current Enabled	Adaptive Peak Current Enabled	Adaptive Peak Current Enabled	Adaptive Peak Current Enabled	Adaptive Peak Current Enabled
BBstFETScale	FET Scaling Enabled	FET Scaling Enabled	FET Scaling Disabled	FET Scaling Enabled	FET Scaling Disabled	FET Scaling Disabled	FET Scaling Enabled	FET Scaling Disabled
FastRSELMode	FAST	FAST	FAST	FAST	RSEL	RSEL	RSEL	RSEL
EnI2CMode	I ² C Control	I ² C Control	I ² C Control	I ² C Control	EN Mode	EN Mode	EN Mode	EN Mode
BBstIPSet1[3:0]	100mA	225mA	400mA	100mA	400mA	300mA	100mA	450mA
BBstIPSet2[3:0]	BBstIPSet1 + 200mA	BBstIPSet1 + 150mA	BBstIPSet1 + 600mA	BBstIPSet1 + 200mA	BBstIPSet1 + 600mA	BBstIPSet1 + 350mA	BBstIPSet1 + 225mA	BBstIPSet1 + 300mA
BBstIP1SS[3:0]	375mA	375mA	750mA	375mA	750mA	350mA	375mA	375mA
BBstIP2SS[3:0]	BBstIPSet1 + 75mA	BBstIPSet1 + 75mA	BBstIPSet1 + 150mA	BBstIPSet1 + 75mA	BBstIPSet1 + 150mA	BBstIPSet1 + 100mA	BBstIPSet1 + 75mA	BBstIPSet1 + 75mA
Slave_Addr	0xD0/0xD1	0xD0/0xD1	0xD0/0xD1	0xD0/0xD1	0xD0/0xD1	0xD0/0xD1	0xD0/0xD1	0xD0/0xD1

Table 4. Register Default Values

REGISTER	NAME	DEVICE								
		MAX20343B	MAX20343E/ MAX20344E	MAX20343F	MAX20343G	MAX20343H	MAX20343I	MAX20343K	MAX20343J	MAX20343N
0x00	ChipID	0x02	0x02	0x02	0x02	0x02	0x02	0x03	0x03	0x03
0x01	BBstCfg0	0x13	0x13	0x93	0x13	0x13	0x12	0x13	0x13	0x93
0x02	BBstVSet	0xCE	0xF2	0xD0	0xCE	0xD0	0xDE	0xCE	0xC7	0xF2
0x03	BBstISet	0x84	0x69	0xC8	0x84	0xC8	0x76	0x84	0x94	0x69
0x04	BBstCfg1	0x81	0xA1	0x84	0x81	0x84	0x84	0x81	0xA1	0xA0
0x05	Status	0x00	0x00	0x02	0x00	0x00	0x00	0x00	0x00	0x00
0x06	Int	0x00	0x00	0x00	0x00	0x00	0x00	0x00	0x00	0x00
0x07	Mask	0x03	0x03	0x03	0x03	0x03	0x03	0x03	0x03	0x03
0x50	LockMsk	0x01	0x01	0x01	0x01	0x01	0x01	0x01	0x01	0x01
0x51	LockUnlock	0xFF	0xFF	0xFF	0xFF	0xFF	0xFF	0xFF	0xFF	0xFF

Typical Application Circuits

Optical Heart Rate LED Supply

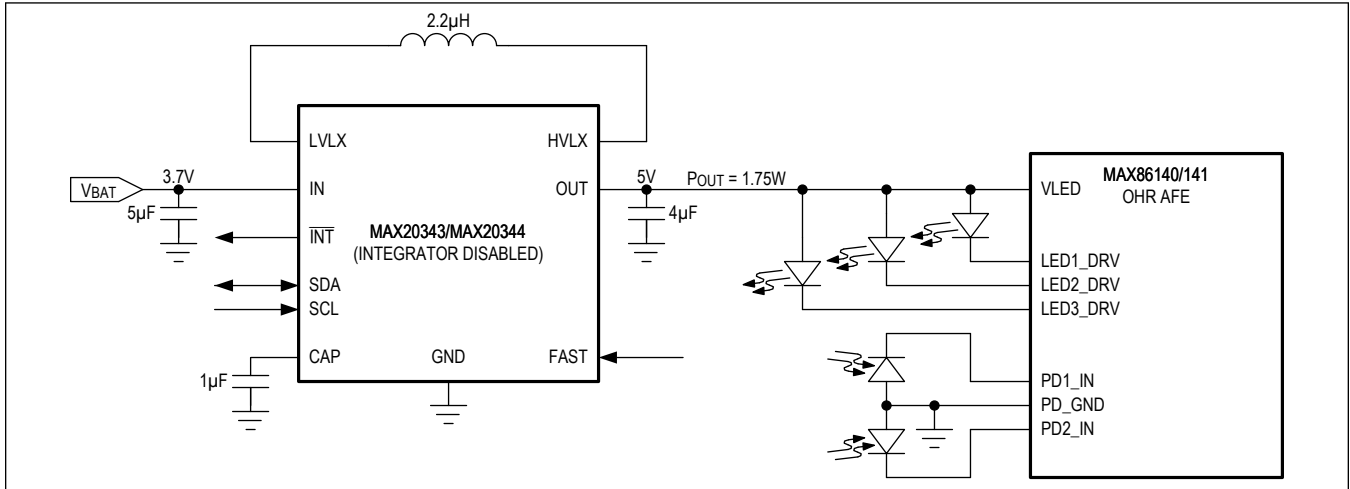

LPWAN Radio Supply

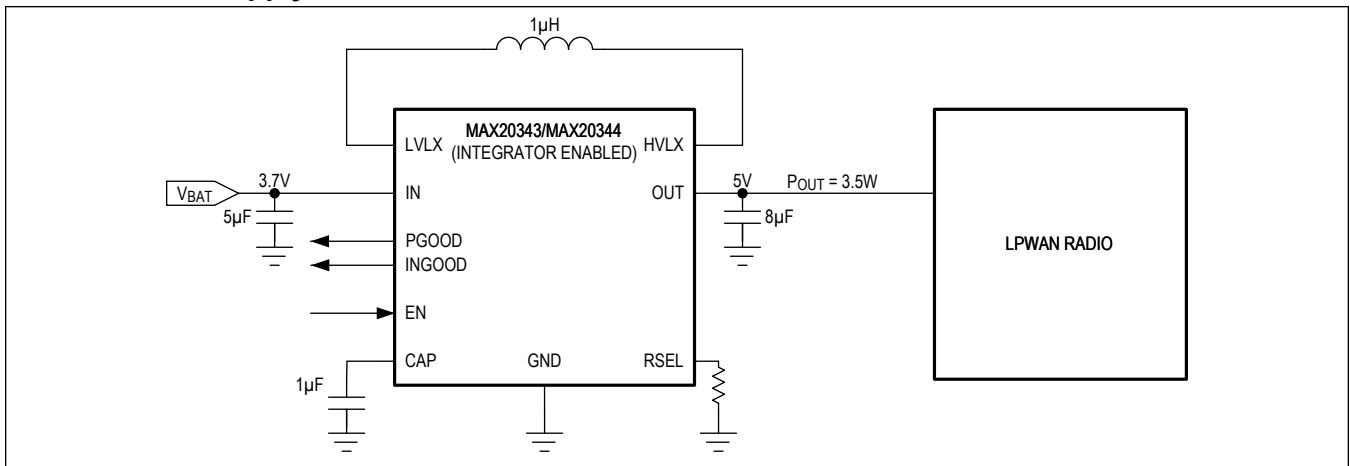

Ordering Information

PART NUMBER	TEMP RANGE	PIN-PACKAGE
MAX20343BEFC+*	-40°C to +85°C	12 FC2QFN
MAX20343BEFC+T*	-40°C to +85°C	12 FC2QFN
MAX20343EEFC+*	-40°C to +85°C	12 FC2QFN
MAX20343EEFC+T*	-40°C to +85°C	12 FC2QFN
MAX20343GEFC+*	-40°C to +85°C	12 FC2QFN
MAX20343GEFC+T*	-40°C to +85°C	12 FC2QFN
MAX20343HEFC+	-40°C to +85°C	12 FC2QFN
MAX20343HEFC+T	-40°C to +85°C	12 FC2QFN
MAX20344EAFC+	-40°C to +125°C	12 FC2QFN
MAX20344EAFC+T	-40°C to +125°C	12 FC2QFN
MAX20343BEWE+	-40°C to +85°C	16 WLP
MAX20343BEWE+T	-40°C to +85°C	16 WLP
MAX20343EEWE+	-40°C to +85°C	16 WLP
MAX20343EEWE+T	-40°C to +85°C	16 WLP
MAX20343FEWE+	-40°C to +85°C	16 WLP
MAX20343FEWE+T	-40°C to +85°C	16 WLP
MAX20343GEWE+	-40°C to +85°C	16 WLP
MAX20343GEWE+T	-40°C to +85°C	16 WLP
MAX20343IEWE+	-40°C to +85°C	16 WLP
MAX20343IEWE+T	-40°C to +85°C	16 WLP
MAX20343JEWE+	-40°C to +85°C	16 WLP
MAX20343JEWE+T	-40°C to +85°C	16 WLP
MAX20343KEWE+*	-40°C to +85°C	16 WLP
MAX20343KEWE+T*	-40°C to +85°C	16 WLP
MAX20343NEWE+*	-40°C to +85°C	16 WLP
MAX20343NEWE+T*	-40°C to +85°C	16 WLP

+Denotes a lead(Pb)-free/RoHS-compliant package.

T = Tape and reel.

*Future product—contact factory for availability.

See [Table 3](#) for specific device settings and defaults to select a part.

Revision History

REVISION NUMBER	REVISION DATE	DESCRIPTION	PAGES CHANGED
0	3/19	Initial release	—
1	3/19	Corrected typos; updated BBstFETScale Bit Description (and corrected typo), and added future product designation to MAX20343EEWE+ and MAX20343EEWE+T in the <i>Ordering Information</i>	19, 21, 25, 34
2	4/19	Updated the <i>General Description, Benefits and Features, Absolute Maximum Ratings, Package Information, Pin Configuration, Pin Description, Buck-Boost Mode, and Inductor Peak and Valley Current Limits</i> sections, and <i>Register Map</i> and BBstCfg0 (0x01) tables; added MAX20343BEFC+ and MAX20343BEFC+T as future parts to the <i>Ordering Information</i>	1, 3, 12–13, 16, 18, 20–21, 34
3	6/19	Removed future part designation from MAX20343EEWE+ and MAX20343EEWE+T in the <i>Ordering Information</i>	34
4	1/20	Updated the <i>General Description, Benefits and Features, Electrical Characteristics, Typical Operating Characteristics, Pin Description, Startup Voltage, Architectural Design, Switching Phases, Buck-Boost Mode, Buck-Only Mode, Inductor Peak and Valley Current Limits, Integrator Control Loop Disable, Input Operating Voltage, I²C-Controlled, Input and Output Capacitance, I²C Interface, Slave Address, and Ordering Information</i> sections; updated the <i>Simplified Block Diagram, Pin Configurations, Functional Diagrams</i> , Figures 4–Figure 7, Table 1, BBstlSet (0x03), BBstCfg1 (0x04), and Table 4; replaced Table 3; added the <i>Inductor Selection and Output Operating Power and Other Optimization</i> sections	1–2, 4–20, 23–25, 28, 32, 34
4.1		Corrected typo	1
5	6/20	Updated <i>Benefits and Features, Electrical Characteristics</i> , and <i>Ordering Information</i> section; removed mention of MAX20343E; replaced the <i>Input and Output Capacitance</i> section, Figure 9, Table 3, and Table 4; added the <i>Soft-Start</i> section	1, 4–6, 18–20, 22, 26–27, 31–32, 35–37
6	9/20	Added MAX20344 to the title, <i>General Description, Benefits and Features, Absolute Maximum Ratings, Electrical Characteristics, Inductor Peak and Valley Current Limits, Input Operating Voltage, Output Operating Power and Other Optimizations, I²C Interface, Slave Address, Optical Heart Rate LED Supply (Typical Application Circuit), LPWAN Radio Supply (Typical Application Circuit)</i> , and <i>Ordering Information</i> sections; updated Tables 2–4 and register 0x03; removed Figures 4 and 6, and renumbered remaining figures	1, 3, 4–6, 17, 19–20, 22, 26–27, 31, 35–37
7	1/21	Updated Single-Pin-Enabled FC2QFN figure in the <i>Pin Configurations</i> section, added details in the <i>Single-Pin-Enabled</i> section, added MAX20343I to Tables 3 and 4, and updated the <i>Ordering Information</i> by adding MAX20343I and removed future part designation from MAX20344EAFC+ and MAX20344EAFC+T	17, 25, 39–40, 42
8	6/21	Corrected Continuous Power Dissipation in the <i>Absolute Maximum Ratings</i> , updated Table 3 and Table 4, and updated <i>Ordering Information</i> by adding MAX20343KEWE+ and MAX20343KEWE+T as future products	7, 10, 39–40, 42
9	8/21	Updated Figure 7 caption, updated Table 3 and Table 4, and updated <i>Ordering Information</i> by adding MAX20343JEWE+, MAX20343JEWE+T, and MAX20343NEWE+, MAX20343NEWE+T as future products	34, 39–40, 42

For pricing, delivery, and ordering information, please visit Maxim Integrated's online storefront at <https://www.maximintegrated.com/en/storefront/storefront.html>.

Maxim Integrated cannot assume responsibility for use of any circuitry other than circuitry entirely embodied in a Maxim Integrated product. No circuit patent licenses are implied. Maxim Integrated reserves the right to change the circuitry and specifications without notice at any time. The parametric values (min and max limits) shown in the Electrical Characteristics table are guaranteed. Other parametric values quoted in this data sheet are provided for guidance.

X-ON Electronics

Largest Supplier of Electrical and Electronic Components

Click to view similar products for [Switching Voltage Regulators](#) category:

Click to view products by [Maxim](#) manufacturer:

Other Similar products are found below :

[FAN53610AUC33X](#) [FAN53611AUC123X](#) [FAN48610BUC33X](#) [FAN48610BUC45X](#) [FAN48617UC50X](#) [R3](#) [430464BB](#) [KE177614](#)
[MAX809TTR](#) [NCV891234MW50R2G](#) [NCP81103MNTXG](#) [NCP81203PMNTXG](#) [NCP81208MNTXG](#) [NCP81109GMNTXG](#)
[SCY1751FCCT1G](#) [NCP81109JMNTXG](#) [AP3409ADNTR-G1](#) [LTM8064IY](#) [LT8315EFE#TRPBF](#) [NCV1077CSTBT3G](#) [XCL207A123CR-G](#)
[MPM54304GMN-0002](#) [MPM54304GMN-0003](#) [XDPE132G5CG000XUMA1](#) [DA9121-B0V76](#) [LTC3644IY#PBF](#) [MP8757GL-P](#)
[MIC23356YFT-TR](#) [LD8116CGL](#) [HG2269M/TR](#) [OB2269](#) [XD3526](#) [U6215A](#) [U6215B](#) [U6620S](#) [LTC3803ES6#TR](#) [LTC3803ES6#TRM](#)
[LTC3412IFE](#) [LT1425IS](#) [MAX25203BATJA/VY+](#) [MAX77874CEWM+](#) [XC9236D08CER-G](#) [ISL95338IRTZ](#) [MP3416GJ-P](#) [BD9S201NUX-](#)
[CE2](#) [MP5461GC-Z](#) [MPQ4415AGQB-Z](#) [MPQ4590GS-Z](#) [MCP1642B-18IMC](#) [MCP1642D-ADJIMC](#)