

MAX20353 Evaluation Kit

Evaluates: MAX20353

General Description

The MAX20353 evaluation kit (EV kit) is a fully assembled and tested circuit for evaluating the MAX20353 wearable charge-management solution with I²C compatibility for feature-rich, low-power wearable applications. The device includes a linear battery charger, smart power selector, two ultra-low quiescent current buck regulators, a buck-boost regulator, a boost regulator, a charge pump, two low-dropout (LDO) linear regulators, three LED current sinks, five GPIO pins, and an LRA/ERM compatible haptic driver with internal pattern storage.

Refer to the MAX20353 IC data sheet for detailed information regarding the operation and features of the device.

Features

- RoHS Compliant
- Proven PCB Layout
- Fully Assembled and Tested
- I²C Serial Interface

Quick Start

Required Equipment

- GPIO controller device
- Adjustable power supply with 0V to 5V capability
- Digital multimeter (DMM)
- I²C controller device
- Cables with grabber connections

Optional Equipment

- Second power supply for LDOs and load switches
- Electronic load
- 10k Ω resistor

Procedure

The EV kit is fully assembled and tested. Follow the steps below to verify basic board operation:

Caution: Do not enable the power supply or external devices until all connections are made.

Ordering Information appears at end of data sheet.

- 1) Connect the GPIO controller device PFN1 (J2 pin 11). Set the output to low.
Optional: If a GPIO controller is unavailable, connect a 10k Ω pullup resistor from PFN1 to BAT (J1 pin 4).
- 2) Connect the I²C controller device to GND (J1 pins 1 and 12, J2 pins 1 and 12), SDA (J2 pin 6) and SCL (J2 pin 7).
- 3) Set the power supply voltage to 3.7V and turn off the supply.
- 4) Connect the positive terminal of the 3.7V to V_{BAT} and the negative terminal to GND.
- 5) Turn on the 3.7V power supply.
- 6) Turn on the GPIO controller device and the I²C controller device.
- 7) Set the GPIO controller output high to enable the MAX20353.
- 8) Measure the voltage on SYS (J1 pin 3 and J5 pin 1) and confirm it equals V_{BAT}. If the SYS voltage is less than 2.7V, set the GPIO controller low for three seconds, then set it back to high.
Optional: If using a 10k Ω pullup from PFN1 to BAT, short PFN1 to GND for three seconds, then release the short.
- 9) To enable Buck1, use the I²C controller to set Buck1En[1:0] = 01.
- 10) Write the values 0x04 to register 0x0F, 0x90 to register 0x10, 0x16 to register 0x11, and 0x01 to register 0x12.
- 11) Write the value 0x35 to register 0x17.
- 12) Measure BK1OUT (J3 pin 6) and confirm it is 1.2V.
- 13) To enable Buck2, use the I²C controller to set Buck1En[1:0] = 01.
- 14) Write the values 0x00 to register 0x0F, 0x94 to register 0x10, 0x26 to register 0x11, and 0x01 to register 0x12.
- 15) Write the value 0x3A to register 0x17.
- 16) Measure BK2OUT (J3 pin 5) and confirm it is 1.8V.
- 17) To configure the other switching regulators and LDOs, refer to the MAX20353 IC data sheet for information regarding the AP interface. Use the optional second power supply as the input to LDOs and switches.
- 18) The EV kit is ready for additional evaluation.

Detailed Description of Hardware

The MAX20353 EV kit evaluates the MAX20353 wearable charge-management solution. The default settings of the EV kit differ from other versions of the IC to allow for flexible evaluation. Refer to Tables 1 through Table 3 for descriptions of the default settings and the readback values of the direct registers and AP registers on reset.

Table 1. Register Bit Default Values

REGISTER BITS	DEFAULT VALUE
	MAX20353A
PFN2PUD_CFG*	Hi-Z
PFN1PUD_CFG*	PU/PD Connected
WriteProtect	Disabled
ILimBlank	Disabled
ILimCntl	500mA
MtChgTmr	0min
FChgTmr	600min
PChgTmr	30min
TShdnTmo	10s
ChgAutoRe	Auto-Restart
VPChg	3.15V
IPChg	10% IFCHG
ChgDone	10% IFCHG
ChgEn	Disabled
ChgAutoStp	Enabled
BatReChg	200mV
BatReg	4.35V
ColdLim	1397.65mV
HotLim	529.41mV
BstISet	425mA
BstIAdptEn	Enabled
BstFastStrt	50ms
BstFetScale	Disabled
BstVSet	20V
Buck1FetScale	Disabled
Buck2FetScale	Disabled
BstSeq	BstEn After 100%
BstEn	Disabled
Buck1VSet	1.8V
Buck1IZCSet	30mA
Buck2VSet	0.9V
Buck2IZCSet	10mA
Buck2ISet	150mA
Buck1ISet	150mA
BootDly**	120ms
Buck2SftStrt	50ms Soft-Start
Buck1SftStrt	50ms Soft-Start

REGISTER BITS	DEFAULT VALUE
	MAX20353A
Buck2En	Disabled
Buck1En	Enabled
LDO1Md	LDO
LDO1En	Disabled
LDO2Md	LDO
LDO2En	Disabled
PassDiscEna***	Enabled
LDO2VSet	3.2V
StayOn	Enabled
SFOUVSet	3.3V
LDO1VSet	1.2V
SysMinVlt	3.6V
SFOUEN	CHGIN
CPVSet	6.6V
CPEn	Disabled
CPSeq	CPEn After 100%
PwrRstCfg	0b0110
Buck2Seq	Buck2En After 100%
Buck1Seq	Buck1En After 100%
BBstEn	Disabled
LDO2Seq	LDO2En After 100%
LDO1Seq	LDO1En After 100%
ThmEn	Disabled
BBstVset	5V
BBstISet	100mA
BatOcThr	1000mA
BBstRipRed	Lower Ripple
BBstInd	4.7μH
BBstSeq	BBstEn After 100%
EmfEn	Disabled
HptSel	ERM
AlcMod	Enabled
HptSysUVLO	3V
HptDrvTmo	10s
ILimMax****	1000mA
T _{CHGIN_SHDN}	100°C

Table 2. I²C Direct Register Default Values

REGISTER	NAME	DEFAULT VALUE
0x00	HardwareID	0x02
0x01	FirmwareID	0x02
0x0B	SystemError	0x00
0x0C	IntMask0	0x00
0x0D	IntMask1	0x00
0x0E	IntMask2	0x40
0x0F	APDataOut0	0x00
0x10	APDataOut1	0x00
0x11	APDataOut2	0x00
0x12	APDataOut3	0x00
0x13	APDataOut4	0x00
0x14	APDataOut5	0x00
0x15	APDataOut6	0x00
0x17	APCmdOut	0x00
0x18	APResponse	0x00
0x19	APDataIn0	0x00
0x1A	APDataIn1	0x00
0x1B	APDataIn2	0x00

REGISTER	NAME	DEFAULT VALUE
0x1C	APDataIn3	0x00
0x1D	APDataIn4	0x00
0x1E	APDataIn5	0x00
0x20	LDODirect	0x00
0x21	MPCDirectWrite	0x00
0x28	HptRAMAddr	0x00
0x29	HptRAMDataH	0x4A
0x2A	HptRAMDataM	0x74
0x2B	HptRAMDataL	0x63
0x2C	LEDStepDirect	0x00
0x2D	LED0Direct	0x00
0x2E	LED1Direct	0x00
0x2F	LED2Direct	0x00
0x30	HptDirect0	0x04
0x31	HptDirect1	0x00
0x32	HptRTI2Camp	0x00
0x33	HptPatRAMAddr	0x00

See Table 3 through Table 7 for pin descriptions of the three connectors J1-J5.

Table 3. Read Opcode Default Values

OPCODE	REGISTER	DEFAULT VALUE
		MAX20353A
GPIO_Config_Read (0x02)	APDataIn0	0x00
	APDataIn1	0x00
	APDataIn2	0x00
	APDataIn3	0x00
	APDataIn4	0x00
GPIO_Control_Read (0x04)	APDataIn0	0x00
MPC_Config_Read (0x07)	APDataIn0	0x00
	APDataIn1	0x00
	APDataIn2	0x00
	APDataIn3	0x00
	APDataIn4	0x00

OPCODE	REGISTER	DEFAULT VALUE
		MAX20353A
InputCurrent_Config_Read (0x11)	APDataIn0	0x06
ThermalShutdown_Config_Read (0x12)	APDataIn0	0x03
Charger_Config_Read (0x15)	APDataIn0	0x0C
	APDataIn1	0x75
	APDataIn2	0xF6
ChargerThermalLimits_Config_Read (0x17)	APDataIn3	0x00
	APDataIn0	0xC6
	APDataIn1	0x00
	APDataIn2	0x00
	APDataIn3	0x4B

Table 3. Read Opcode Default Values (continued)

OPCODE	REGISTER	DEFAULT VALUE
		MAX20353A
ChargerThermalReg_ ConfigRead (0x19)	APDataIn0	0x00
	APDataIn1	0x00
	APDataIn2	0x1F
	APDataIn3	0x00
	APDataIn4	0x00
Charger_Control_Read (0x1B)	APDataIn0	0x00
Charger_JEITAHyst_ControlRead (0x1D)	APDataIn0	0x86
Bst_Config_Read (0x31)	APDataIn0	0x00
	APDataIn1	0x06
	APDataIn2	0x0D
	APDataIn3	0x3C
	APDataIn4	0x00
Buck1_Config_Read (0x36)	APDataIn0	0x00
	APDataIn1	0xA8
	APDataIn2	0x26
	APDataIn3	0x01
	APDataIn4	0x07
Buck2_Config_Read (0x3B)	APDataIn0	0x00
	APDataIn1	0x82
	APDataIn2	0x06
	APDataIn3	0x00
	APDataIn4	0x07
LDO1_Config_Read (0x41)	APDataIn0	0x00
	APDataIn1	0x1C
	APDataIn2	0x07
LDO2_Config_Read (0x43)	APDataIn0	0x00
	APDataIn1	0x17
	APDataIn2	0x07
ChargePump_Config_Read (0x47)	APDataIn0	0x00
	APDataIn1	0x00
	APDataIn2	0x07
SFOUT_Config_Read (0x49)	APDataIn0	0x05

OPCODE	REGISTER	DEFAULT VALUE
		MAX20353A
MONMux_Config_Read (0x51)	APDataIn0	0x00
BBst_Config_Read (0x71)	APDataIn0	0x00
	APDataIn1	0x02
	APDataIn2	0x19
	APDataIn3	0x50
	APDataIn4	0x07
Hpt_Config_Read0 (0xA1)	APDataIn0	0x02
	APDataIn1	0xD0
	APDataIn2	0x97
	APDataIn3	0x00
	APDataIn4	0x05
Hpt_Config_Read1 (0xA3)	APDataIn0	0x01
	APDataIn1	0x00
	APDataIn2	0x02
	APDataIn3	0x8B
	APDataIn4	0x7F
Hpt_Config_Read2 (0xA5)	APDataIn0	0x04
	APDataIn1	0x00
	APDataIn2	0x02
	APDataIn3	0x8B
	APDataIn4	0x7F
Hpt_Config_Read3 (0xA7)	APDataIn0	0xCC
	APDataIn1	0x32
	APDataIn2	0xFF
	APDataIn3	0x04
	APDataIn4	0x24
Hpt_Config_Read4 (0xA9)	APDataIn0	0x06
	APDataIn1	0x00
	APDataIn2	0x02
	APDataIn3	0x04
	APDataIn4	0x06
Hpt_SYS_Threshold_Config_Read (0xA7)	APDataIn0	0x8B
Hpt_Lock_Config_Read (0xA9)	APDataIn0	0x00
Hpt_EMF_Threshold_Config_Read (0xAB)	APDataIn0	0x19

Table 4. Connector J1

PIN	SIGNAL	DESCRIPTION
1	GND	Ground
2	CHGIN	+28V/-5.5V Protected Charger Input
3	SYS	System Load Connection
4	BAT	Battery Connection
5	THM	Battery Thermistor Measurement Connection
6	TPU	Battery Temperature Thermistor Measurement Pullup. Do not exceed 1mA load on TPU.
7	SET	External Resistor For Battery Charge Current Level Setting
8	LED0	Current Sink Output 0
9	LED1	Current Sink Output 1
10	LED2	Current Sink Output 2
11	BSTOUT	Boost Regulator Output
12	GND	Ground

Table 5. Connector J2

PIN	SIGNAL	DESCRIPTION
1	GND	Ground
2	MON	Monitor Multiplexer Output
3	$\overline{\text{ALRT}}$	Fuel Gauge Alert Output
4	$\overline{\text{INT}}$	Interrupt Open-Drain Output
5	$\overline{\text{RST}}$	Reset Output. Active-Low, Open-Drain Output
6	SDA	I ² C Serial Data Input/Open-Drain Output
7	SCL	I ² C Serial Clock Input
8	MPC1	Multipurpose Control I/O 1
9	MPC0	Multipurpose Control I/O 0
10	PFN2	Configurable Power Mode Control Pin ($\overline{\text{KOUT}}$)
11	PFN1	Configurable Power Mode Control PIN ($\overline{\text{KIN}}$)
12	GND	Ground

Table 6. Connector J3

PIN	SIGNAL	DESCRIPTION
1	CELL	Fuel Gauge Voltage
2	N.C.	Not Connected
3	CPOUT	Charge Pump Output
4	SFOUT	Safe Out LDO
5	BK2OUT	Buck2 Regulator Output
6	BK1OUT	Buck1 Regulator Output
7	N.C.	Not Connected
8	BBOUT	Buck-Boost Regulator Output

Table 7. Connector J4

PIN	MAX20353	DESCRIPTION
1	DRP	ERM/LRA Haptic Driver Positive Output
2	DRN	ERM/LRA Haptic Driver Negative Output
3	L1IN	LDO1 Input
4	L1OUT	LDO1 Output
5	L2IN	LDO2 Input
6	L2OUT	LDO2 Output
7	VDIG	Internal Reference Supply
8	CAP	Internal Reference Supply

Table 8. Connector J5

PIN	MAX20353	DESCRIPTION
1	SYS	System Load Connection
2	N.C.	Not Connected
3	N.C.	Not Connected
4	N.C.	Not Connected
5	N.C.	Not Connected
6	MPC4	Multipurpose Configuration I/O 4
7	MPC3	Multipurpose Configuration I/O 3
8	MPC2	Multipurpose Configuration I/O 2

Component Suppliers

SUPPLIER	WEBSITE
Murata Americas	www.murata.com/en-us

Note: Indicate that you are using the MAX20353 when contacting these component suppliers.

MAX20353 EV Kit Bill of Materials

ITEM	REF_DES	QTY	MFG PART #	MANUFACTURER	VALUE	DESCRIPTION	COMMENTS
1	C1, C2, C5, C10, C11	5	C1005X5R1V225M050BC	TDK	2.2UF	CAPACITOR; SMT (0402); CERAMIC CHIP; 2.2UF; 35V; TOL=20%; MODEL=C SERIES; TG=-55 DEGC TO +85 DEGC; TC=X5R	
2	C3, C4, C6, C8, C15	5	C1005X5R0J475K050BC	TDK	4.7UF	CAPACITOR; SMT (0402); CERAMIC CHIP; 4.7UF; 6.3V; TOL=10%; TG=-55 DEGC TO +85 DEGC; TC=X5R	
3	C7	1	C0402C273K4RAC	KEMET	0.027UF	CAPACITOR; SMT; 0402; CERAMIC; 0.027uF; 16V; 10%; X7R; -55degC to +125degC; 0 +/-15% degC MAX.	
4	C9, C13, C14, C16, C18, C19	6	GRM155R60J226ME11	MURATA	22UF	CAPACITOR; SMT (0402); CERAMIC CHIP; 22UF; 6.3V; TOL=20%; TC=X5R ;	
5	C12, C20	2	C1608X5R1E106M080AC; CL10A106MA8NRNC; GRM188R61E106MA73; ZRB18AR61E106ME01; GRT188R61E106ME13	TDK;SAMSUNG ELECTRONICS; MURATA;;MURATA	10UF	CAPACITOR; SMT (0603); CERAMIC CHIP; 10UF; 25V; TOL=20%; TG=-55 DEGC TO +85 DEGC; TC=X5R	
6	C17	1	GRM155R71A104KA01; C1005X7R1A104K050BB; C0402C104K8RAC	MURATA;TDK;KEMET	0.1UF	CAPACITOR; SMT (0402); CERAMIC CHIP; 0.1UF; 10V; TOL=10%; MODEL=GRM SERIES; TG=-55 DEGC TO +125 DEGC; TC=X7R;	
7	J1, J2	2	TS-112-T-A	SAMTEC	TS-112-T-A	CONNECTOR; MALE; THROUGH HOLE; PRECISION MACHINED TERMINAL STRIP; STRAIGHT; 12PINS	
8	J3-J5	3	TS-108-T-A	SAMTEC	TS-108-T-A	CONNECTOR; MALE; THROUGH HOLE; PRECISION MACHINED TERMINAL STRIP; STRAIGHT; 8PINS	
9	L1, L4	2	DFE201610E-4R7M=P2	MURATA	4.7UH	INDUCTOR; SMT (2016); METAL ALLOY CHIP; 4.7UH; TOL=+/-20%; 1.3A	
10	L2, L3	2	DFE201612E-2R2M	MURATA	2.2UH	INDUCTOR; SMT (0806); WIREWOUND CHIP; 2.2UH; TOL=+/-20%; 1.8A	
11	R1	1	RCC-0402PW1001F	INTERNATIONAL MANUFACTURING SERVICE	1K	RESISTOR; 0402; 1K OHM; 1%; 100PPM; 0.080W; THICK FILM	
12	R3	1	ERJ-2RKF3902X; CRCW040239K0FK	PANASONIC;VISHAY DALE	39K	RESISTOR, 0402, 39K OHM, 1%, 100PPM, 0.0625W, THICK FILM	
13	U1	1	MAX20353	MAXIM	MAX20353	EVKIT PART- IC; WEARABLE POWER NAMAGEMENT SOLUTION; PACKAGE OUTLINE; WLP 56 PINS; 0.5MM PITCH; PKG. CODE: W563A4+1; PKG. OUTLINE: 21-100104	
14	PCB	1	MAX20353	MAXIM	PCB	PCB:MAX20353	-
TOTAL		33					

MAX20353 EV Kit Schematic

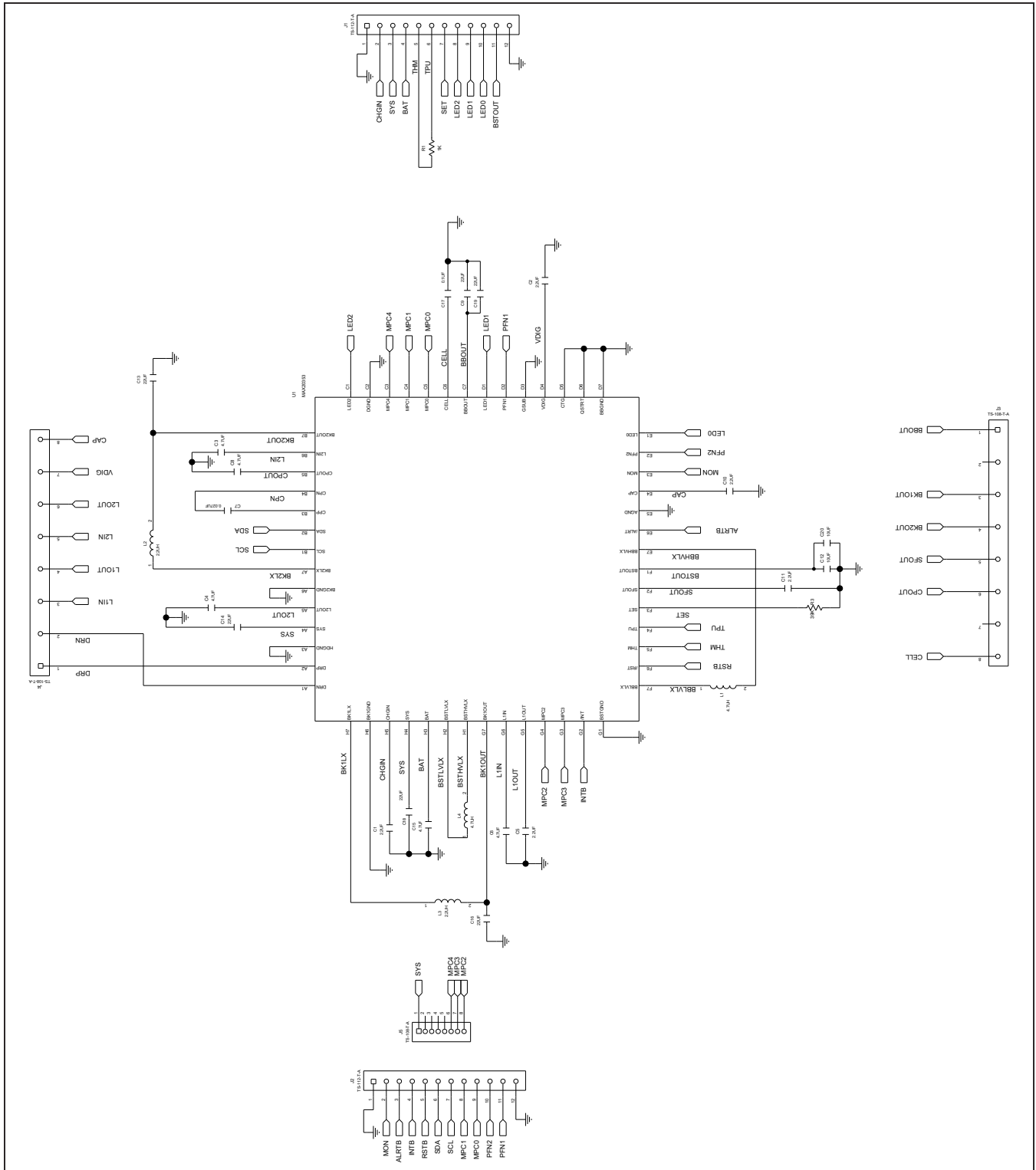

MAX20353 EV Kit PCB Layout

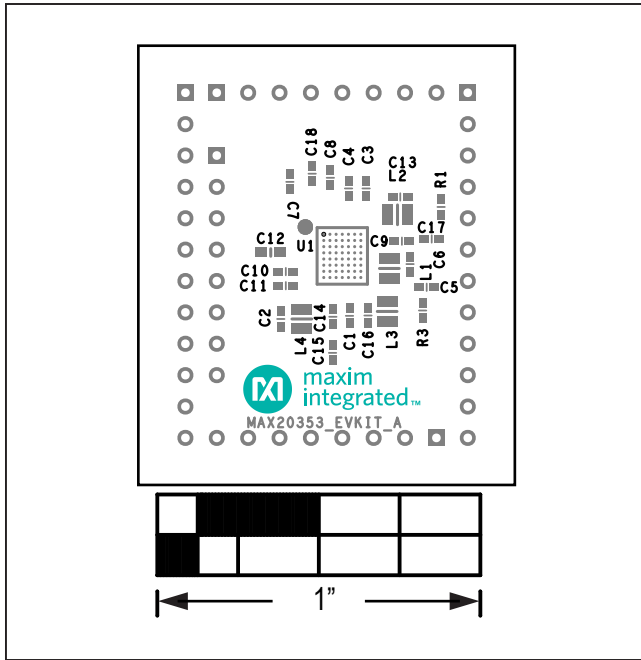

MAX20353 EV Kit—Top Silkscreen

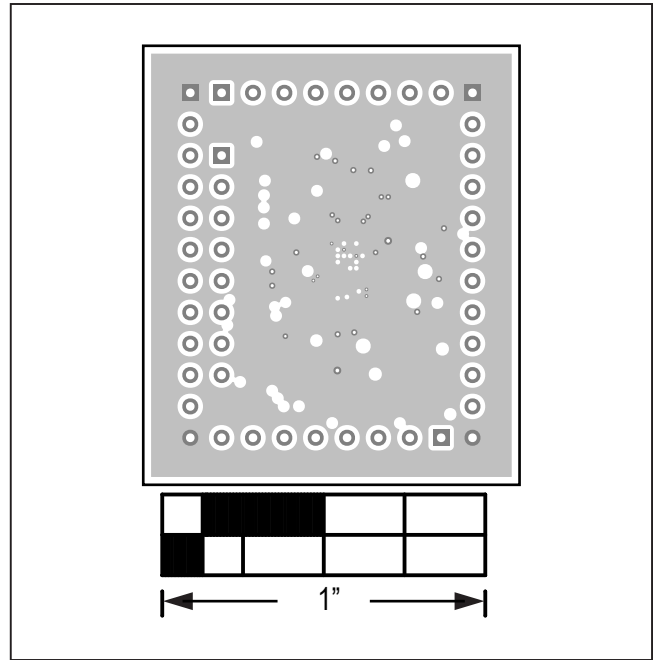

MAX20353 EV Kit—GND Plane

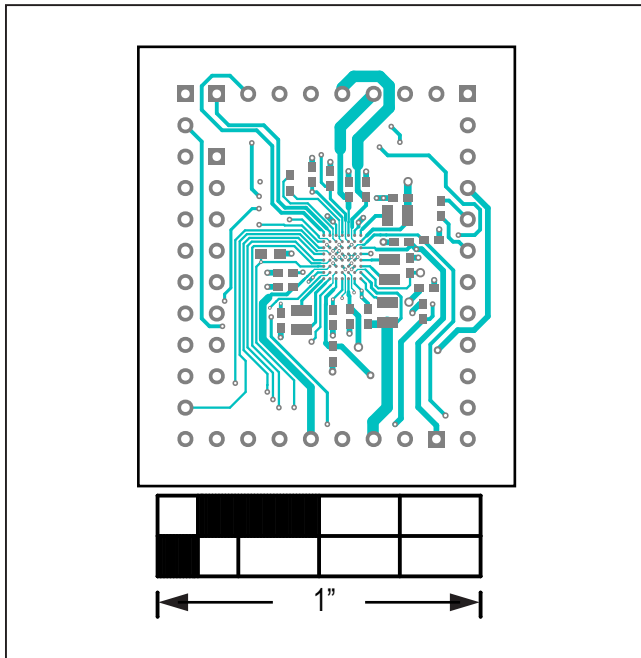

MAX20353 EV Kit—Top Copper

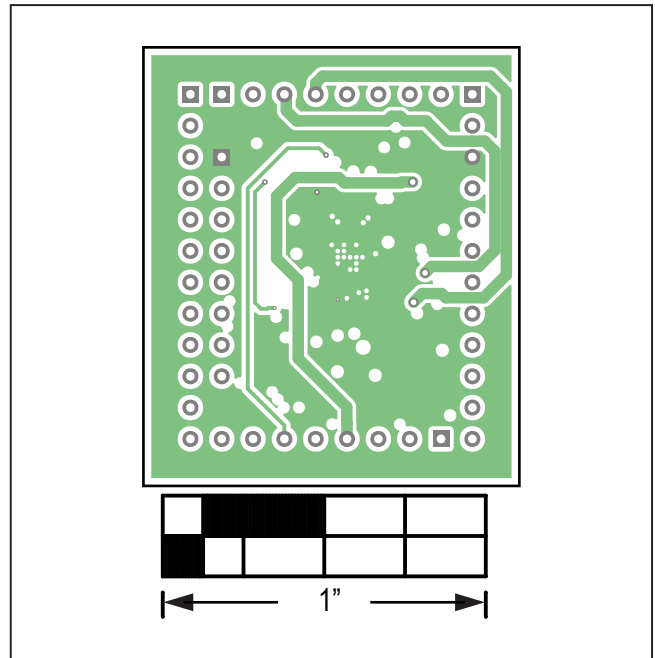

MAX20353 EV Kit—System Plane

MAX20353 EV Kit PCB Layout (continued)

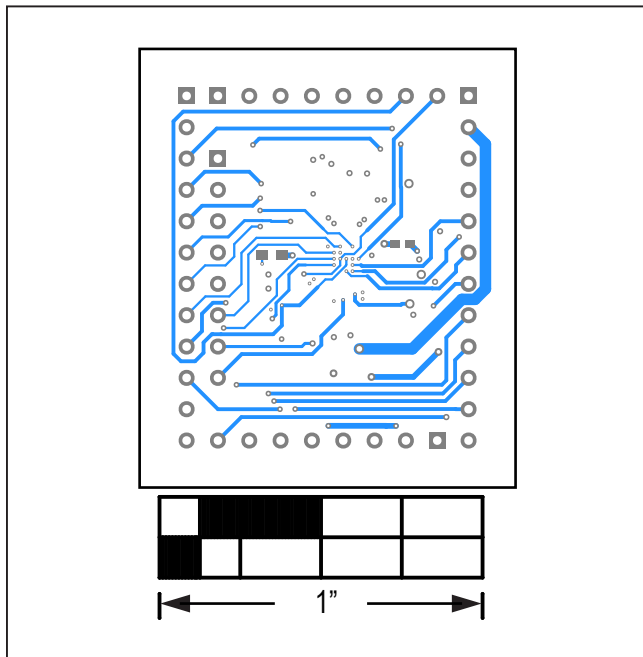

MAX20353 EV Kit—Bottom Copper

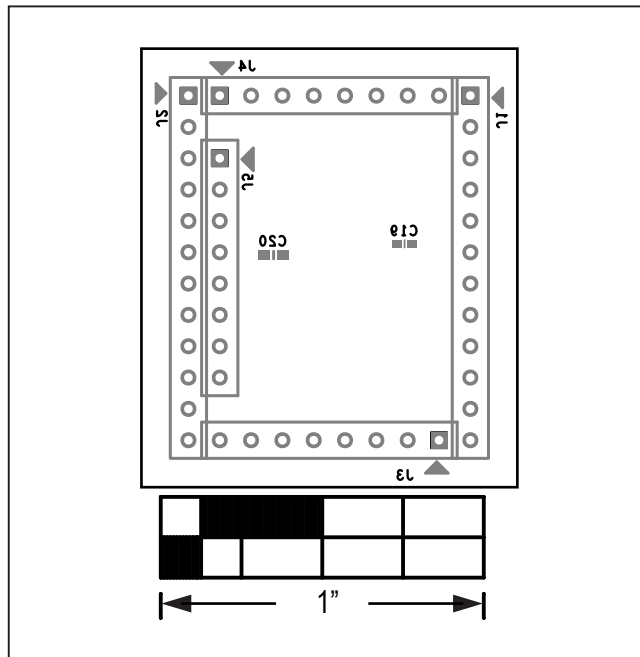

MAX20353 EV Kit—Bottom Silkscreen

Ordering Information

PART	TYPE
MAX20353EVKIT#	EV Kit

#Denotes RoHS Compliant

Revision History

REVISION NUMBER	REVISION DATE	DESCRIPTION	PAGES CHANGED
0	2/20	Initial release	—

For pricing, delivery, and ordering information, please visit Maxim Integrated's online storefront at <https://www.maximintegrated.com/en/storefront/storefront.html>.

Maxim Integrated cannot assume responsibility for use of any circuitry other than circuitry entirely embodied in a Maxim Integrated product. No circuit patent licenses are implied. Maxim Integrated reserves the right to change the circuitry and specifications without notice at any time.

X-ON Electronics

Largest Supplier of Electrical and Electronic Components

Click to view similar products for [Power Management IC Development Tools](#) category:

Click to view products by [Maxim](#) manufacturer:

Other Similar products are found below :

[EVAL-ADM1168LQEBZ](#) [EVB-EP5348UI](#) [MIC23451-AAAYFL EV](#) [MIC5281YMME EV](#) [DA9063-EVAL](#) [ADP122-3.3-EVALZ](#) [ADP130-0.8-EVALZ](#) [ADP130-1.2-EVALZ](#) [ADP130-1.5-EVALZ](#) [ADP130-1.8-EVALZ](#) [ADP1712-3.3-EVALZ](#) [ADP1714-3.3-EVALZ](#) [ADP1715-3.3-EVALZ](#) [ADP1716-2.5-EVALZ](#) [ADP1740-1.5-EVALZ](#) [ADP1752-1.5-EVALZ](#) [ADP1828LC-EVALZ](#) [ADP1870-0.3-EVALZ](#) [ADP1871-0.6-EVALZ](#) [ADP1873-0.6-EVALZ](#) [ADP1874-0.3-EVALZ](#) [ADP1882-1.0-EVALZ](#) [ADP199CB-EVALZ](#) [ADP2102-1.25-EVALZ](#) [ADP2102-1.875EVALZ](#) [ADP2102-1.8-EVALZ](#) [ADP2102-2-EVALZ](#) [ADP2102-3-EVALZ](#) [ADP2102-4-EVALZ](#) [ADP2106-1.8-EVALZ](#) [ADP2147CB-110EVALZ](#) [AS3606-DB](#) [BQ24010EVM](#) [BQ24075TEVM](#) [BQ24155EVM](#) [BQ24157EVM-697](#) [BQ24160EVM-742](#) [BQ24296MEVM-655](#) [BQ25010EVM](#) [BQ3055EVM](#) [NCV891330PD50GEVB](#) [ISLUSBI2CKIT1Z](#) [LM2744EVAL](#) [LM2854EVAL](#) [LM3658SD-AEV/NOPB](#) [LM3658SDEV/NOPB](#) [LM3691TL-1.8EV/NOPB](#) [LM4510SDEV/NOPB](#) [LM5033SD-EVAL](#) [LP38512TS-1.8EV](#)