

Click [here](#) to ask about the production status of specific part numbers.

## MAX20361 Evaluation Kit

Evaluates: MAX20361

### General Description

The MAX20361 evaluation kit (EV kit) is a fully assembled and tested PCB that evaluates the MAX20361 single/multi-cell solar harvester with maximum power point tracking (MPPT) and harvest counter. The EV kit features a Pmod™ connector, allowing the USB2PMB2 adapter board to provide I<sup>2</sup>C interface.

The EV kit features an on-board adjustable current source and a monocrystalline solar cell to generate input current to the IC. It also features a supercapacitor and resistor load to evaluate the integrated charger of the MAX20361. The EV kit includes load current monitoring circuitry for convenient sensing of the MAX20361 output current.

The EV kit software controls the USB2PMB2 adapter board over the USB, which generates I<sup>2</sup>C commands. The EV kit ships with jumpers installed and supply voltages set to typical operating values.

### Features

- USB-Powered Operation
- Proven High-Speed USB PCB Layout
- Pmod I<sup>2</sup>C Interface
- Flexible Configuration
- On-Board Solar Cell and Current Monitoring
- Windows® 8/Windows 10-Compatible GUI Software
- Fully Assembled and Tested

### Evaluation Kit Contents

- MAX20361 EV kit
- USB2PMB2 adapter board
- USB A to micro-B cable

*[Ordering Information](#) appears at end of data sheet.*

### MAX20361 EV Kit Photo



*Windows is a registered trademark and service mark of Microsoft Corporation.*

*Pmod is a trademark of Digilent Inc.*

### MAX20361 EV Kit Files

FILE	DESCRIPTION
MAX20361EVKit.exe	PC GUI Program

### Quick Start

#### Required Equipment

- MAX20361 EV kit
- USB2PMB2 adapter board
- USB A to micro-B cable
- Windows PC with USB ports
- DC power supply

**Note:** In the following sections, software-related items are identified by **bold** text. Text in **bold** refers to items directly from the install of EV kit software. Text which is **bold and underlined** refers to items from the Windows operating system.

#### Procedure

The EV kit is fully assembled and tested. Use the following steps to verify board operations.

**Caution: Do not turn on the power supply until all connections are completed.**

- 1) Visit [www.maximintegrated.com](http://www.maximintegrated.com) to download the latest version of the EV kit software, MAX20361EVKitSetupVxxx.ZIP located on the MAX20361 EV kit web page. Download the EV kit software to a temporary folder and unzip the ZIP file.
- 2) Install the EV kit software on your computer by running the MAX20361EVKitSetupVxxx.EXE program inside the temporary folder.
- 3) Verify that all jumpers are in their default positions, as shown in [Table 1](#).
- 4) Connect the USB2PMB2 adapter board to J1 Pmod connector on the EV kit.
- 5) Connect a USB A-to-micro-B cable between the PC and the X1 port on the USB2PMB2. USB driver should be installed automatically.
- 6) Connect the USB A-to-micro-B cable between the PC and the USB1 port on the EV kit.
- 7) Start the MAX20361 EV kit tool. The EV kit software main window appears, as shown in [Figure 1](#).
- 8) Supply 3.8V to the MAX20361 by connecting power to pin 1 of jumper JU11.
- 9) If the connection is successfully established, the status bar on the bottom displays **Connected**.
- 10) The EV kit is now ready for additional evaluations.

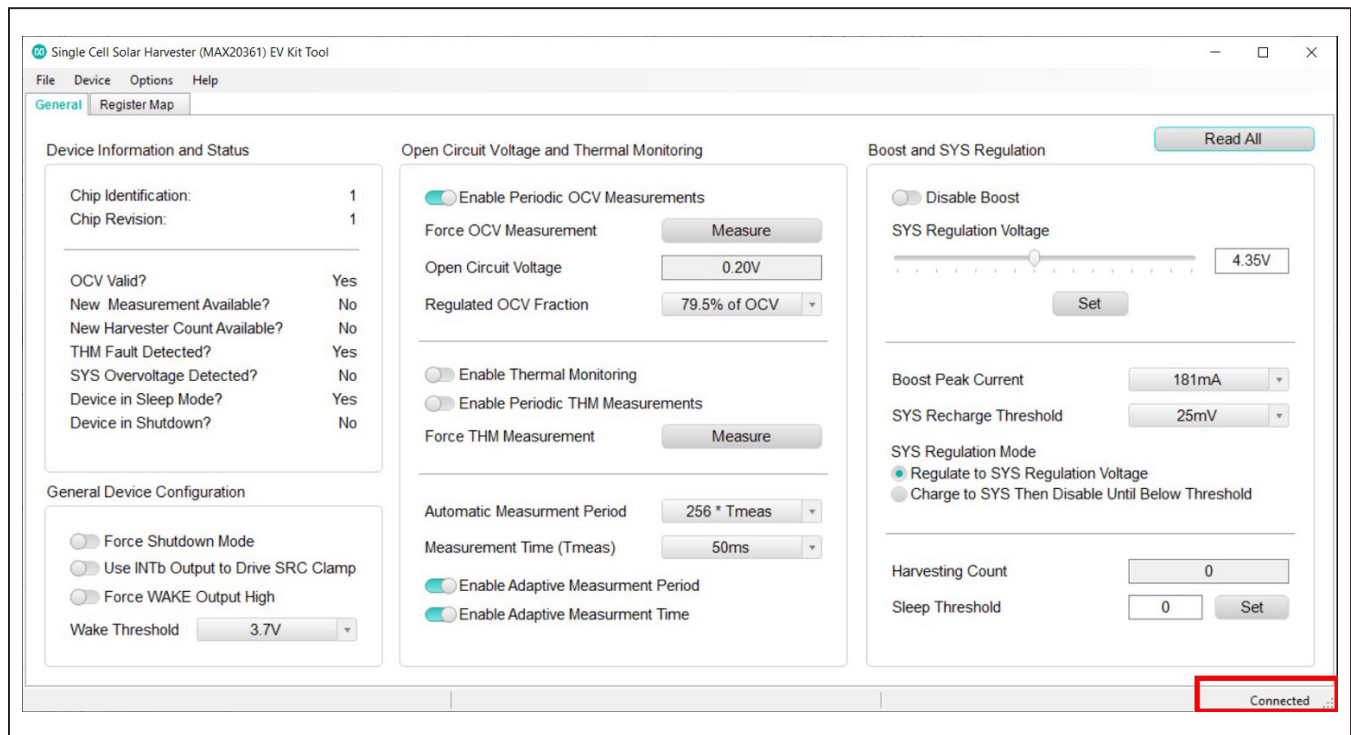

Figure 1. The Status of the GUI Shows Connected Ready for Further Evaluations

## Detailed Description of Software

### Software Startup

Upon starting the program, the EV kit software automatically searches for the USB interface circuit and then for the IC device addresses. The EV kit enters the normal operating mode when the connection is established, and addresses are found. If the USB connection is not detected, the status bar displays **Not Connected**. If the USB connection is detected but the MAX20361 is not found, the status bar displays **MAX20361 Not Found**.

The **Read All** button reads all the registers visible on the current tab page. All statuses are polled continuously. The polling feature can be disabled in the **Options** section of the menu bar by selecting **Disable Polling**.

### ToolStrip Menu Bar

The **ToolStrip** menu bar (Figure 2) is located at the top of the GUI window.

This bar comprises **File**, **Device**, **Options**, and **Help** menus; each function is detailed in the following sections.

#### File Menu

The **File** menu contains the option to exit out of the GUI program.

#### Device Menu

The **Device** menu provides the ability to connect or disconnect the EV kit to the GUI. If a board is disconnected while the GUI is open the GUI displays **Not Connected** in the lower right corner. If the device is then plugged back in, the bottom right corner of the GUI displays **Connected**. The **I2C Read/Write** in the **Device** menu allows the user to read from or write to a selected register with a specified slave address.

#### Options Menu

The **Options** menu provides additional setting to access more features offered by the GUI. The **Disable polling** option lets the user read the registers manually instead

of getting automatically frequent register updates from the IC.

#### Help Menu

The **Help** menu contains the **About** option, which displays the GUI splash screen indicative of which GUI version is being used.

#### Tab Controls

The MAX20361 EV kit software GUI provides a convenient way to test the features of the MAX20361. Each tab contains controls relevant to various blocks of the device. Changing these interactive controls triggers a write operation to the MAX20361 to update the register contents.

#### General Tab

The **General** tab (Figure 3) provides all important information and options to set up the MAX20361 general configurations. The **Device Information and Status** panel provides statuses for several conditions such as the availability of harvester count, fault detection, SYS overvoltage, etc. **Open Circuit Voltage** configuration and **Thermal Monitoring** settings can be found in the middle panel. Configuring the boost regulator and battery charging voltage can be accomplished via settings in the **Boost and SYS Regulation** panel.

#### Register Map Tab

The **Register Map** tab (Figure 4) provides all names and values of MAX20361 registers. The user can click **Read All** on the top right corner to perform a burst read of all registers.

The left table shows the register to be read from or written to. The right table contains descriptions for each register field of the selected 8-bit register. All bits, along with their field names, are displayed at the bottom of the page.

To set a bit, click the bit label. Bold text represents logic 1 and regular text represents logic 0. To configure the changes to the device, click the **Write** button at the bottom right.



Figure 2. The ToolStrip Menu Items

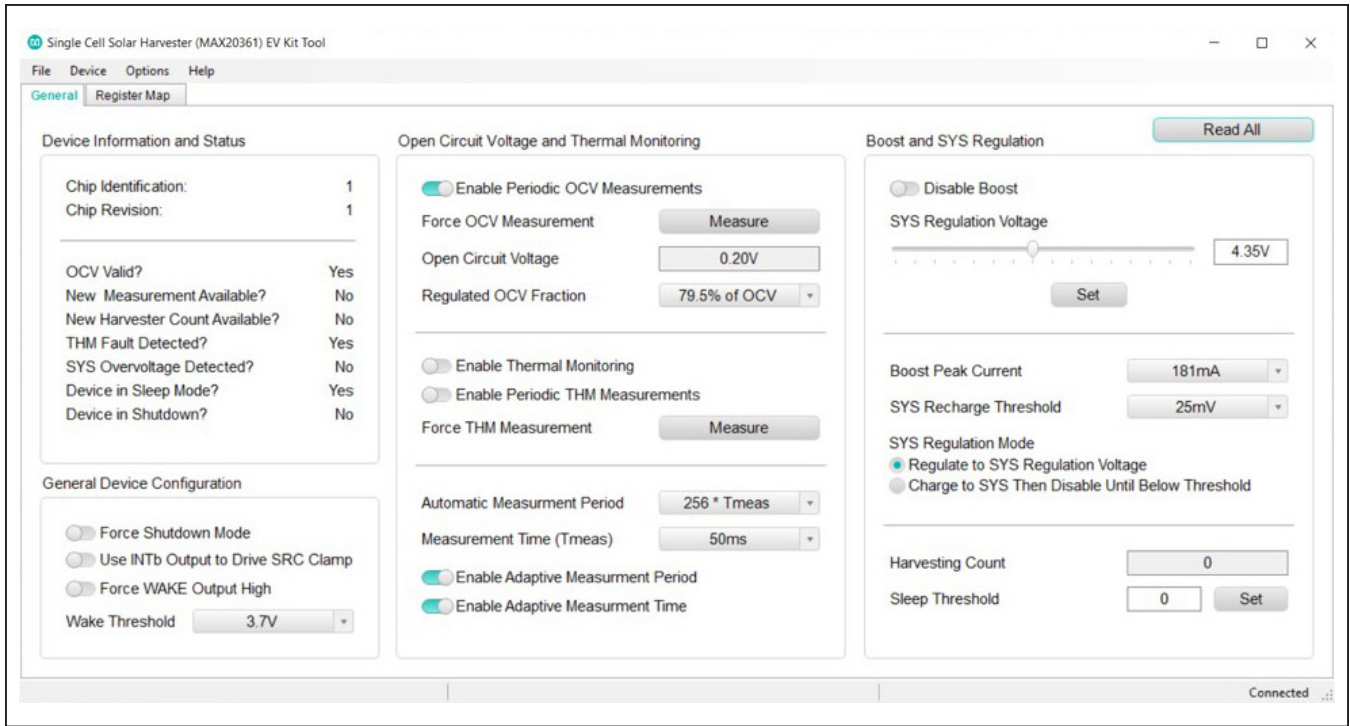

Figure 3. General Tab

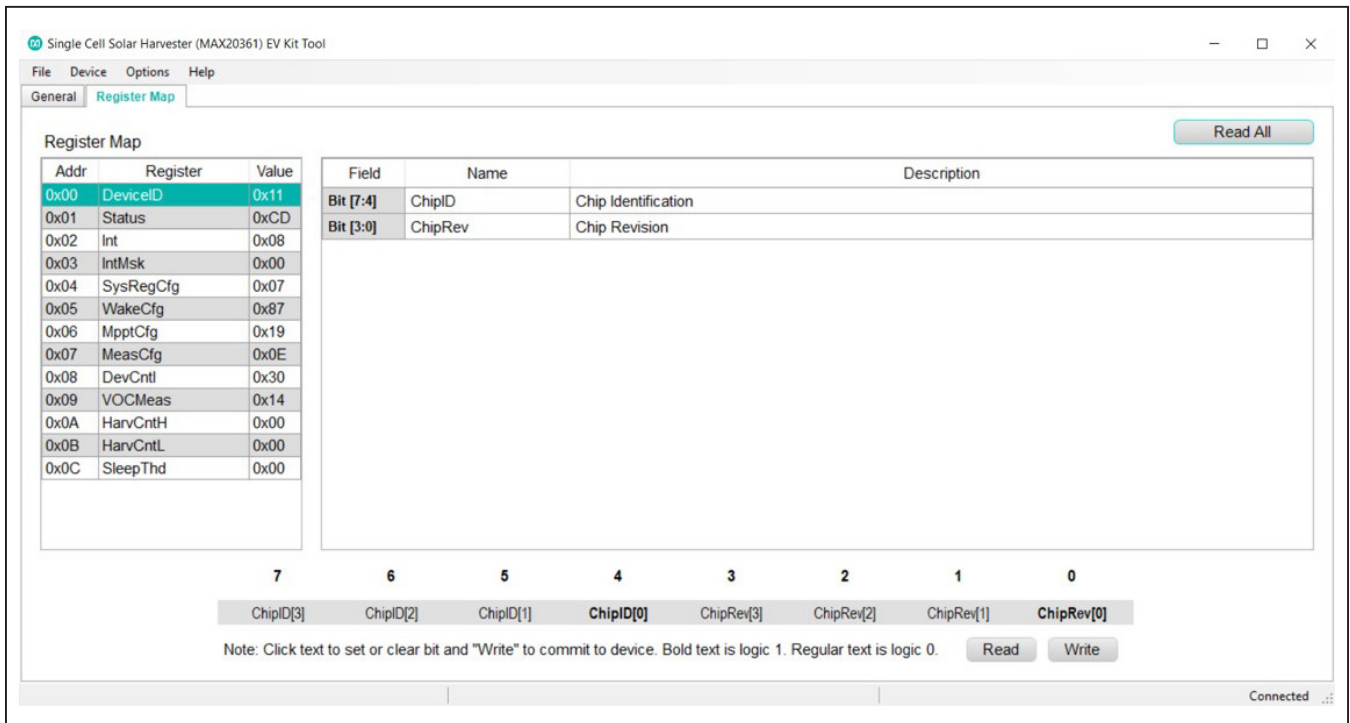

Figure 4. Register Map Tab

### Detailed Description of Hardware

The MAX20361 EV kit evaluates the MAX20361 single/multi-cell solar harvester with MPPT and harvest counter, which communicates over the I<sup>2</sup>C interface. The EV kit demonstrates the IC features such as the boost regulator, integrated charging and protection circuit, open circuit voltage measurement, MPPT, cold-startup, and thermal monitoring. The EV kit uses the IC in a 12-bump (1.63mm x 1.23mm) wafer-level package (WLP) on a proven, four-layer PCB design. The EV kit operates from the USB +5V DC and therefore does not require an external power supply. Alternatively, the EV kit can be powered with an external power supply through the SYS test point TP20.

### Supply Voltage Selection

This section covers the procedure to power the MAX20361 EV kit either from power supply at SYS or cold-startup.

#### Supply Voltage from SYS

Follow these steps to power the MAX20361 EV kit with an external power supply voltage:

- 1) Connect default jumpers according to [Table 1](#) and the setup [Procedure](#) above.
- 2) Connect a DC power supply (3.8V) to SYS through pin 1 of JU11 or pin 2 of JU9.
- 3) If connection is successfully established, the status bar on the bottom displays **Connected**.

**Table 1. Jumper Table (JU1-JU21)**

JUMPER	SHUNT POSITION	DESCRIPTION
JU1	1-2	Connect the on-board solar cell SC1 to the input of U1
	3-4	Connect the external solar cell (if installed) to the input of U1
	5-6	Connect the external source (through TP2) to the input of U1
	7-8	Connect the output of the on-board current source to the input of U1
JU2	1-2*	Connect $\overline{EN}$ of U1 to LED1
	3-4	Connect $\overline{EN}$ of U1 to connector S1
JU3	1-2*	Connect WAKE of U1 to LED2
	3-4	Connect WAKE of U1 to connector S1
JU4	1-2*	Pullup SCL of U1 to 3.3V
JU5	1-2*	Connect input circuitry selected in JU1 to SRC and LX of U1
JU6	1-2*	Pullup SDA of U1 to 3.3V
JU7	1-2*	Connect REF of U1 to the voltage divider circuitry
JU8	1-2*	Connect THM of U1 to voltage divider formed by pullup resistor R6 and pulldown thermistor R7
JU9	1-2	Connect SYS of U1 to connector S1
JU11	1-2	Connect SYS of U1 to the on-board load circuitry
JU12	1-2	Select supercapacitor SC2 as the on-board load
JU13	1-2	Select resistor R16 as the on-board load
JU14	1-2	Select resistor R15 as the on-board load
JU15	1-2	Select resistor R17 to adjust the on-board current source
	3-4	Select resistor R18 to adjust the on-board current source
	5-6	Select resistor R19 to adjust the on-board current source
	7-8	Select resistor R20 to adjust the on-board current source
JU16	1-2	Connect the output of on-board current source to ground
JU17	1-2*	Connect SRC of U1 to the drain of MOSFET Q2
JU18	1-2	Connect $\overline{INT}$ of U1 to the gate of MOSFET Q2
	2-3*	Connect $\overline{INT}$ of U1 to LED4
JU21	1-2*	Connect SYS of U1 to the on-board current monitoring circuitry

\*Default position.

### Cold-Startup

The cold start feature of the MAX20361 allows the device to start up even if VSYS is below the wake threshold or absent. Refer to the *Cold-Startup* section of the IC data-sheet for a complete description.

- 1) Connect default jumpers according to [Table 1](#) and the setup [Procedure](#) above. Do not connect any power to SYS, pin 1 of JU11 or pin 2 of JU9.
- 2) Connect pin 1 and 2 of jumper JU1 to use the on-board solar cell SC1.
- 3) Put a light source above the solar cell for a few minutes. Mobile phone's flashlight or desk lamp may be used.
- 4) If connection is successfully established, the status bar on the bottom displays **Connected**.

### On-Board Current Source

This section covers the procedure to use the on-board current source of MAX20361 EV kit.

#### Hardware setting

- 1) Follow the default jumper settings from [Table 1](#) and the setup [Procedure](#) above.

- 2) Connect pin 7 and 8 of jumper JU1 to use the on-board current source.
- 3) Connect pin 3 and 4 of jumper JU15 to select R18 301Ω.
- 4) Use the potentiometer R21 to adjust the input current to SRC. R21 is used to set the voltage at TP14. Refer to the following formula for the input current:

$$I_{SRC} = \frac{2.85V - V_{TP14}}{R_{17 \text{ or } R_{18 \text{ or } R_{19 \text{ or } R_{20}}}}$$

The input current in this example is approximately 4.13mA.

- 5) Connect pin 1 and 2 of jumper JU11 to use the on-board load circuitry.
- 6) Connect pin 1 and 2 of jumper JU13 to select load resistor R16.

#### GUI Program

Follow these steps (see [Figure 5](#)) to set up the regulated voltage at SRC (the input side):

- 1) Toggle to disable the **Periodic OCV Measurements**.
- 2) Enter 0.91V to the **Open Circuit Voltage** type box and click **Set**. The voltage at SRC should be approximately 0.7V.

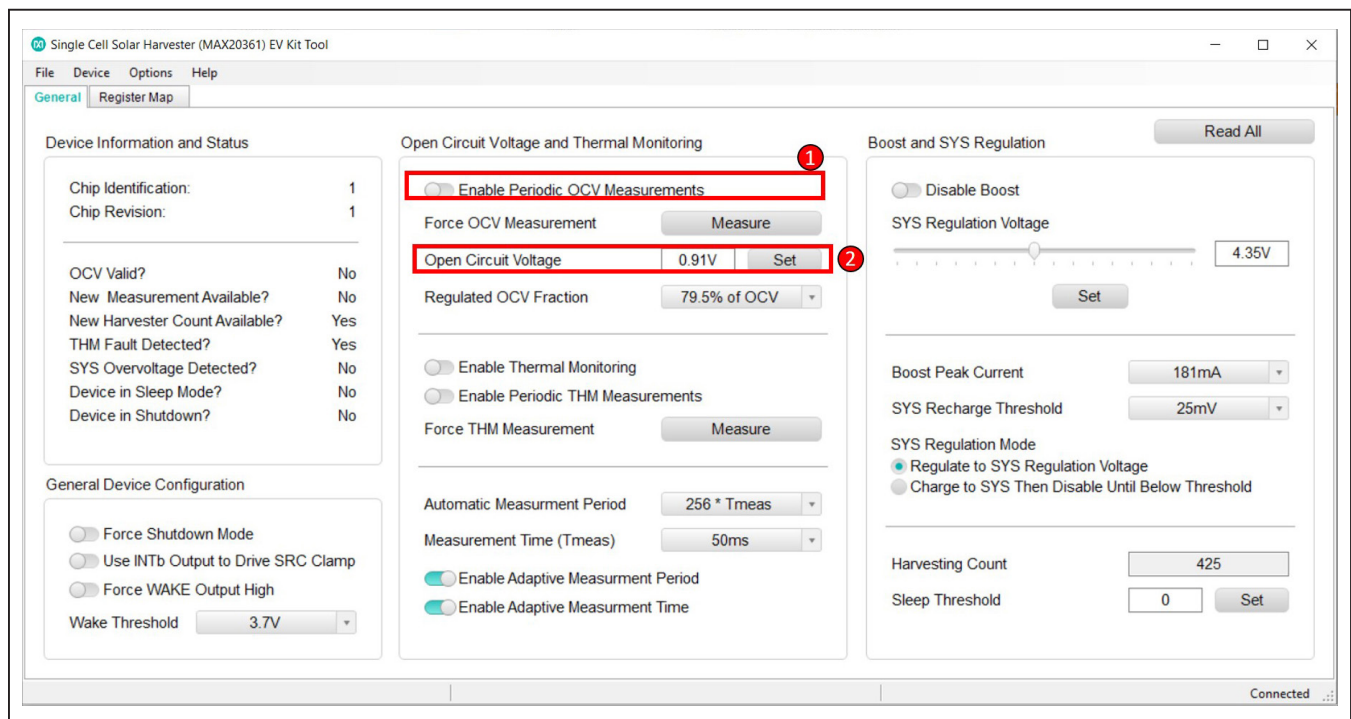

Figure 5. On-Board Current Source GUI Setup

## Charging Supercapacitor and Source Clamping

This section covers the procedure to charge the on-board supercapacitor along with source clamping feature.

### Hardware setting

- 1) Follow the default jumper settings from [Table 1](#) and the setup [Procedure](#) above.
- 2) Connect a DC power supply (3.8V) to SYS via pin 2 of JU9.
- 3) Follow hardware setting of the [On-Board Current Source](#) above with one exception: connect pin 1 and 2 of JU15.
- 4) Disconnect pin 1 and 2 of jumper JU13. Connect pin 1 and 2 of jumper JU12 to select the supercapacitor SC2.

- 5) Connect pin 1 and 2 of jumper JU18 for source clamp circuitry.

### GUI Program

Follow these steps (see [Figure 6](#)) to set up source clamp circuitry while charging the on-board supercapacitor:

- 1) Toggle the button to enable **Use INTb Output to Drive SRC Clamp**. Remove the DC power supply (3.8V) at SYS via pin 2 of JU9.
- 2) Toggle to disable the **Periodic OCV Measurements**.
- 3) Enter 0.91V to the **Open Circuit Voltage** type box and click **Set**. The voltage at SRC should be approximately 0.7V. The voltage at SYS is slowly rising to the **SYS Regulation Voltage** (default at 4.35V).

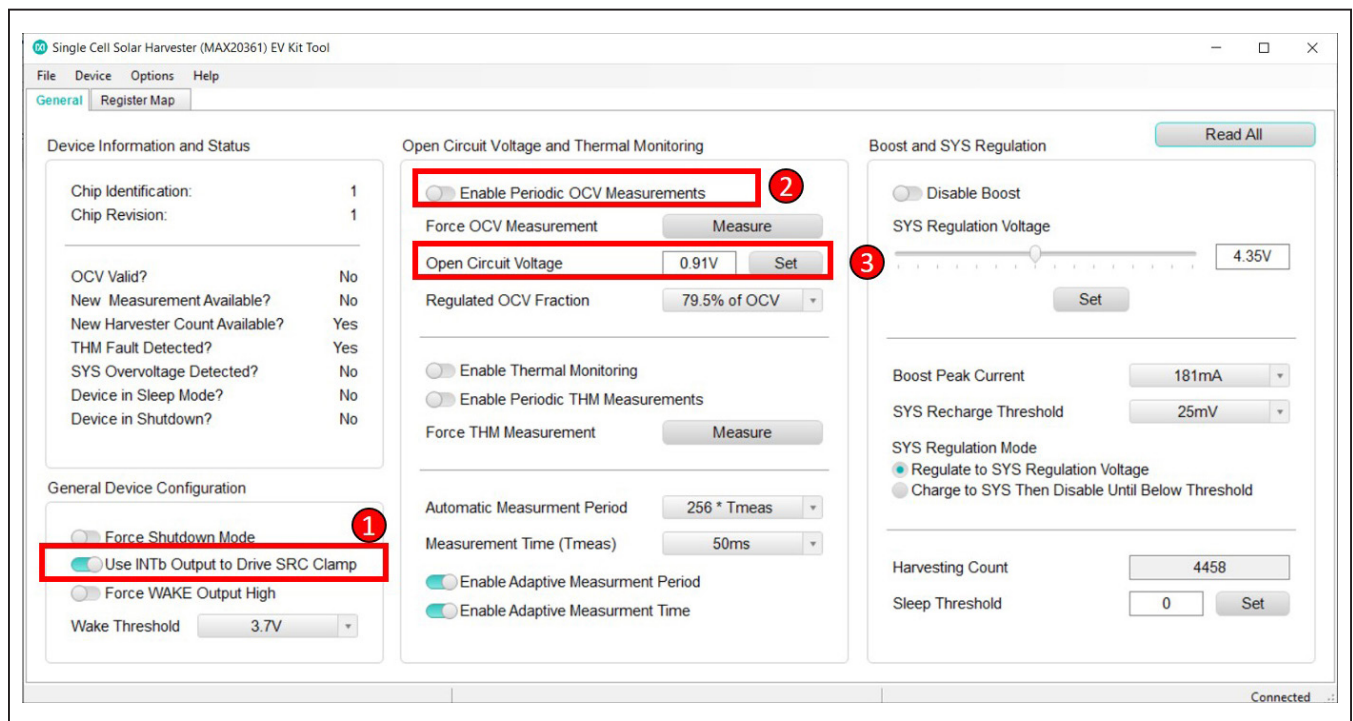

Figure 6. Charging Supercapacitor and Source Clamp GUI Setup

## Ordering Information

PART	TYPE
MAX20361EVKIT#	EV Kit

#Denotes RoHS compliance.

MAX20361 EV Kit Bill of Materials

ITEM	QTY	REF DES	MAXINV	MFG PART #	MANUFACTURER	VALUE	DESCRIPTION
1	7	C1, C3, C5-C8, C10	20-0001U-19A	CL05B105KQ5NQC; GRM155R70J105KA12	SAMSUNG ELECTRONICS; MURATA	1UF	CAPACITOR; SMT (0402); CERAMIC CHIP; 1UF; 6.3V; TOL=10%; TG=-55 DEGC TO +125 DEGC; TC=X7R
2	2	C2, C11	20-0010U-B65	GRM155R60J106ME44; GRM155R60J106ME47; C1005X5R0J106M050BC; CL05A106MQ5NUN; C0402C106M9PAC	MURATA;MURATA; TDK;SAMSUNG ELECTRONICS; KEMET	10UF	CAPACITOR; SMT (0402); CERAMIC CHIP; 10UF; 6.3V; TOL=20%; TG=-55 DEGC TO +85 DEGC; TC=X5R
3	4	C4, C13, C15, C16	20-000U1-19A	GRM155R70J104KA01	MURATA	0.1UF	CAPACITOR; SMT (0402); CERAMIC CHIP; 0.1UF; 6.3V; TOL=10%; TG=-55 DEGC TO +125 DEGC; TC=X7R
4	1	C9	20-004U7-56	GRM21BR71A475KA73; LMK212B7475KG-T; C2012X7R1A475K125AC	MURATA; TAIYO YUDEN; TDK	4.7UF	CAPACITOR; SMT (0805); CERAMIC CHIP; 4.7UF; 10V; TOL=10%; TG=-55 DEGC TO +125 DEGC; TC=X7R
5	1	C12	EC111000002734	CL21B106KPQNNN; LMK212AB7106KG; C0805X106K8RACAUTO; GRM21BR71A106KA73; C2012X7R1A106K125AC	SAMSUNG; TAIYO YUDEN; KEMET;MURATA; TDK	10UF	CAP; SMT (0805); 10UF; 10%; 10V; X7R; CERAMIC CHIP
6	1	C14	20-004U7-252	C1005X5R1A475K050	TDK	4.7UF	CAPACITOR; SMT (0402); CERAMIC CHIP; 4.7UF; 10V; TOL=10%; TG=-55 DEGC TO +85 DEGC; TC=X5R
7	1	C17	20-000U1-B8	GRM155R71A104KA01; C1005X7R1A104K050BB; C0402C104K8RAC	MURATA; TDK;KEMET	0.1UF	CAPACITOR; SMT (0402); CERAMIC CHIP; 0.1UF; 10V; TOL=10%; MODEL=GRM SERIES; TG=-55 DEGC TO +125 DEGC; TC=X7R; NOT RECOMMENDED FOR NEW DESIGN-USE 20-000u1-04A
8	4	D1-D4	30-1N4148W7F-00	1N4148W-7-F	DIODES INCORPORATED	1N4148W-7-F	DIODE; SWT; SMT (SOD-123); PIV=100V; IF=0.3A; -65 DEGC TO +150 DEGC
9	1	J1	01-PEC06DBAN12P-19	PEC06DBAN	SULLINS ELECTRONICS CORP.	PEC06DBAN	CONNECTOR; MALE; THROUGH HOLE; .1IN CONTACT CENTER; BREAKAWAY HEADER; RIGHT ANGLE; 12PINS; NOTE: ALTERNATE PIN NUMBERING
10	2	JU1, JU15	EH111000002472	TSW-104-07-F-D	SAMTEC	TSW-104-07-F-D	CONNECTOR; MALE; SMT; 0.025 IN SQ POST HEADER; STRAIGHT; 8PINS; 2X4
11	2	JU2, JU3	01-67996104HLF4P-19	67996-104HLF	FCI CONNECT	67996-104HLF	CONNECTOR; MALE; SMT; FCI BERGSTIK UNSHROUDED BREAKAWAY HEADER; STRAIGHT; 4PINS
12	13	JU4-JU9, JU11-JU14, JU16, JU17, JU21	01-PCC02SAAN2P-21	PCC02SAAN	SULLINS	PCC02SAAN	CONNECTOR; MALE; THROUGH HOLE; BREAKAWAY; STRAIGHT THROUGH; 2PINS; -65 DEGC TO +125 DEGC
13	1	JU18	01-PBC03SABN3P-21	PBC03SABN	SULLINS	PBC03SABN	CONNECTOR; MALE; THROUGH HOLE; BREAKAWAY; STRAIGHT; 3PINS
14	1	L1	EL111000002015	DFE201612E-4R7M	MURATA	4.7UH	INDUCTOR; SMT (0806); METAL; 4.7UH; 20%; 1.20A
15	1	LED1	ED111000004434	KS DELPS1.22-TIVH-68-H3Q4	OSRAM	KS DELPS1.22-TIVH-68-H3Q4	DIODE; LED; SUPER RED; SMT; VF=2.2V; IF=0.02A
16	2	LED2, LED3	ED111000004432	KP DELPS1.FP-UGVI-34-Z555	OSRAM	KP DELPS1.FP-UGVI-34-Z555	DIODE; LED; PURE GREEN; SMT; VF=2.9V; IF=0.01A
17	1	LED4	30-LSL29KG1J21Z-00	LS L29K-G1J2-1-Z	OSRAM	LS L29K-G1J2-1-Z	DIODE; LED; SMART; RED; SMT (0603); PIV=1.8V; IF=0.02A; -40 DEGC TO +100 DEGC
18	4	MH1-MH4	02-SOM35016H-00	9032	KEYSTONE	9032	MACHINE FABRICATED; ROUND-THRU HOLE SPACER; NO THREAD; M3.5; 5/8IN; NYLON
19	1	Q1	90-MMBT2907A-16	MMBT2907A	FAIRCHILD SEMICONDUCTOR	MMBT2907A	TRAN; SMALL SIGNAL TRANSISTOR; PNP; SOT-23; PD-(0.35W); IC-(-0.6A); VCEO-(-60V)
20	1	Q2	EQ111000004398	DMN2230U	DIODES INCORPORATED	DMN2230U	TRAN; NCH; ENHANCEMENT MODE MOSFET; SOT-23; PD-(0.6W); I-(2A); V-(20V)
21	3	R1, R2, R9	80-0001K-23	CRCW04021K00FK; RC0402FR-071KL; MCR01MZPF1001	VISHAY DALE; YAGEO PHICOMP; ROHM SEMI	1K	RESISTOR; 0402; 1K; 1%; 100PPM; 0.0625W; THICK FILM
22	2	R4, R5	80-004K7-23	CRCW04024K70FK; MCR01MZPF4701	VISHAY DALE; ROHM SEMICONDUCTOR	4.7K	RESISTOR; 0402; 4.7K OHM; 1%; 100PPM; 0.0625W; THICK FILM
23	1	R6	80-0022K-23	CRCW040222K0FK	VISHAY DALE	22K	RESISTOR; 0402; 22K OHM; 1%; 100PPM; 0.0625W; THICK FILM
24	1	R7	ER111000004407	64WR200KLF	TT ELECTRONICS	200K	RES; THROUGH HOLE; 200K; 10%; +/-100PPM/DEGC; 0.25W
25	1	R8	80-002K2-23	CRCW04022K20FK; RC0402FR-072K2L	VISHAY DALE; YAGEO PHICOMP	2.2K	RESISTOR; 0402; 2.2K OHM; 1%; 100PPM; 0.0625W; THICK FILM
26	3	R11, R12, R22	80-0100K-BA37	ERJ-PA2F1003	PANASONIC	100K	RESISTOR; 0402; 100K OHM; 1%; 100PPM; 0.2W; THICK FILM
27	1	R13	80-063K4-AA18	CRCW040263K4FK	VISHAY DALE	63.4K	RESISTOR; 0402; 63.4K OHM; 1%; 100PPM; 0.063W; THICK FILM
28	1	R14	80-049K9-18	CRCW040249K9FK; 9C04021A4992FLHF3	VISHAY DALE; YAGEO	49.9K	RESISTOR; 0402; 49.9K; 1%; 100PPM; 0.0625W; THICK FILM
29	2	R15, R24	80-0010K-23	CRCW040210K0FK; RC0402FR-0710KL	VISHAY DALE; YAGEO PHICOMP	10K	RESISTOR; 0402; 10K; 1%; 100PPM; 0.0625W; THICK FILM
30	1	R16	80-049R9-S3	RCL122549R9FK	VISHAY DRALORIC	49.9	RESISTOR; 1225; 49.9 OHM; 1%; 100PPM; 2.0W; THICK FILM
31	1	R17	80-030R1-24	CRCW060330R1FK	VISHAY DALE	30.1	RESISTOR; 0603; 30.1 OHM; 1%; 100PPM; 0.10W; THICK FILM



MAX20361 EV Kit Bill of Materials (continued)

ITEM	QTY	REF DES	MAXINV	MFG PART #	MANUFACTURER	VALUE	DESCRIPTION
32	1	R18	80-0301R-19	CRCW0603301RFK	VISHAY DALE	301	RESISTOR; 0603; 301 OHM; 1%; 100PPM; 0.10W; THICK FILM
33	1	R19	80-03K01-23	CRCW04023K01FK	VISHAY DALE	3.01K	RESISTOR; 0402; 3.01 K OHM; 1%; 100PPM; 0.063W; THICK FILM
34	1	R20	80-09K09-AA23	ERJ-2RKF9091	PANASONIC	9.09K	RESISTOR; 0402; 9.09K OHM; 1%; 100PPM; 0.1W; THICK FILM
35	1	R21	ER0531	64WR50KLF	TT ELECTRONICS	50K	RES; THROUGH HOLE; 50K; 10%; +/-100PPM/DEGC; 0.25W
36	1	R23	80-022R1-AA23	ERJ-2RKF22R1	PANASONIC	22.1	RES; SMT (0402); 22.1; 1%; +/-100PPM/DEGC; 0.10W
37	1	R25	80-006R8-CA55	CRCW20106R80KFHP	VISHAY DRALORIC	6.8	RESISTOR; 2010; 6.8 OHM; 1%; 100PPM; 1W; THICK FILM
38	1	R26	80-008M2-23	CR0402-16W-825JT	VENKEL LTD.	8.2M	RESISTOR; 0402, 8.2M OHM, 5%, 100PPM, 0.0625W, THICK FILM
39	1	R29	80-0001R-U27	CRT0805-CY-001RELF	BOURNS	1	RESISTOR; 0805, 10HM, 0.25%, 25PPM, 0.10W, THICK FILM
40	1	R30	ER111000004703	CRCW04024R99FN	VISHAY	4.99	RES; SMT (0402); 4.99; 1%; +/-200PPM/DEGC; 0.063W
41	1	S1	EH111000002454	PPTC041LGBN-RC	SULLINS ELECTRONICS CORP	PPTC041LGBN-RC	CONNECTOR; FEMALE; THROUGH HOLE; RIGHT ANGLE; 4PINS
42	1	SC1	EQ111000004410	KXOB25-14X1F	IXYS CORPORATION	KXOB25-14X1F	IC; SNSR; IXOLAR HIGH EFFICIENCY SOLARBIT; SMT
43	1	SC2	EC111000004409	KR-5R5V224-R	EATON POWERING BUSINESS WORLDWIDE	0.22F	CAP; THROUGH HOLE-RADIAL LEAD; 0.22F; -20% TO +80%; 5.5V; ELECTRIC DOUBLE LAYER CAPACITOR
44	20	SU1-SU20	01-929953302P-24	929953-30	3M ELECTRONIC SOLUTIONS DIVISION	929953-30	CONNECTOR; FEMALE; THROUGH HOLE; 929 SERIES; SHUNT CONNECTOR; STRAIGHT; 2PINS
45	3	TP1, TP5, TP7	02-TPMINI5001-00	5001	KEYSTONE	N/A	TEST POINT; PIN DIA=0.1IN; TOTAL LENGTH=0.3IN; BOARD HOLE=0.04IN; BLACK; PHOSPHOR BRONZE WIRE SILVER PLATE FINISH; RECOMMENDED FOR BOARD THICKNESS=0.062IN; NOT FOR COLD TEST
46	4	TP2, TP3, TP6, TP19	02-TPMINI5000-00	5000	KEYSTONE	N/A	TEST POINT; PIN DIA=0.1IN; TOTAL LENGTH=0.3IN; BOARD HOLE=0.04IN; RED; PHOSPHOR BRONZE WIRE SILVER PLATE FINISH; RECOMMENDED FOR BOARD THICKNESS=0.062IN; NOT FOR COLD TEST
47	3	TP4, TP14, TP16	02-TPMINI5003-00	5003	KEYSTONE	N/A	TEST POINT; PIN DIA=0.1IN; TOTAL LENGTH=0.3IN; BOARD HOLE=0.04IN; ORANGE; PHOSPHOR BRONZE WIRE SILVER PLATE FINISH; RECOMMENDED FOR BOARD THICKNESS=0.062IN; NOT FOR COLD TEST
48	2	TP8, TP13	02-TPMINI5116-00	5116	KEYSTONE	N/A	TEST POINT; PIN DIA=0.1IN; TOTAL LENGTH=0.3IN; BOARD HOLE=0.04IN; GREEN; PHOSPHOR BRONZE WIRE SILVER PLATE FINISH; RECOMMENDED FOR BOARD THICKNESS=0.062IN; NOT FOR COLD TEST
49	4	TP9-TP12	02-TPMINI5011-00	5011	KEYSTONE	N/A	TEST POINT; PIN DIA=0.125IN; TOTAL LENGTH=0.445IN; BOARD HOLE=0.063IN; BLACK; PHOSPHOR BRONZE WIRE SILVER PLATE FINISH; RECOMMENDED FOR BOARD THICKNESS=0.062IN; NOT FOR COLD TEST
50	1	TP15	02-TPMINI5119-00	5119	KEYSTONE	N/A	TEST POINT; PIN DIA=0.1IN; TOTAL LENGTH=0.3IN; BOARD HOLE=0.04IN; PURPLE; PHOSPHOR BRONZE WIRE SILVER PLATE FINISH; RECOMMENDED FOR BOARD THICKNESS=0.062IN; NOT FOR COLD TEST
51	3	TP18, TP20, VCC	02-TPMINI5002-00	5002	KEYSTONE	N/A	TEST POINT; PIN DIA=0.1IN; TOTAL LENGTH=0.3IN; BOARD HOLE=0.04IN; WHITE; PHOSPHOR BRONZE WIRE SILVER; NOT FOR COLD TEST
52	1	U1	00-SAMPLE-01	MAX20361AEWC+	MAXIM	MAX20361AEWC+	EVKIT PART - IC; MAX20361; SINGLE CELL SOLAR HARVESTER; WLP12
53	1	U2	10-NC7WZ16P6X-X	NC7WZ16P6X	FAIRCHILD SEMICONDUCTOR	NC7WZ16P6X	IC; BUF; TINY LOGIC; UHS DUAL BUFFER; SC70-6
54	1	U3	10-MAX8880EUT-U	MAX8880EUT+	MAXIM	MAX8880EUT+	IC; VREG; ULTRA-LOW-IQ LOW-DROPOUT LINEAR REGULATOR WITH POK; SOT23-6
55	1	U4	10-MAX4245AXT-X	MAX4245AXT+	MAXIM	MAX4245AXT+	IC; OPAMP; ULTRA-SMALL; RAIL-TO-RAIL I/O WITH DISABLE; SINGLE SUPPLY; LOW-POWER OP AMP; GAIN=110DB; SC70-6
56	1	U5	10-MAX4372HEUK-U	MAX4372HEUK+	MAXIM	MAX4372HEUK+	IC; AMP; LOW-COST; MICROPOWER; HIGH-SIDE CURRENT-SENSE AMPLIFIER WITH VOLTAGE OUTPUT; SOT23-5
57	1	U6	10-MAX11613EUA-U	MAX11613EUA+	MAXIM	MAX11613EUA+	IC; ADC; LOW-POWER; 4-CHANNEL; 12C; 12-BIT ADC; UMAX8
58	1	PCB	EPCB20361	MAX20361	MAXIM	PCB	PCB:MAX20361
TOTAL	127						
DO NOT PURCHASE(DNP)							
ITEM	QTY	REF DES	MAXINV	MFG PART #	MANUFACTURER	VALUE	DESCRIPTION
TOTAL	0						
PACKOUT (These are purchased parts but not assembled on PCB and will be shipped with PCB)							
ITEM	QTY	REF DES	MAXINV	MFG PART #	MANUFACTURER	VALUE	DESCRIPTION
TOTAL	0						

MAX20361 EV Kit Schematics

MECHANICAL

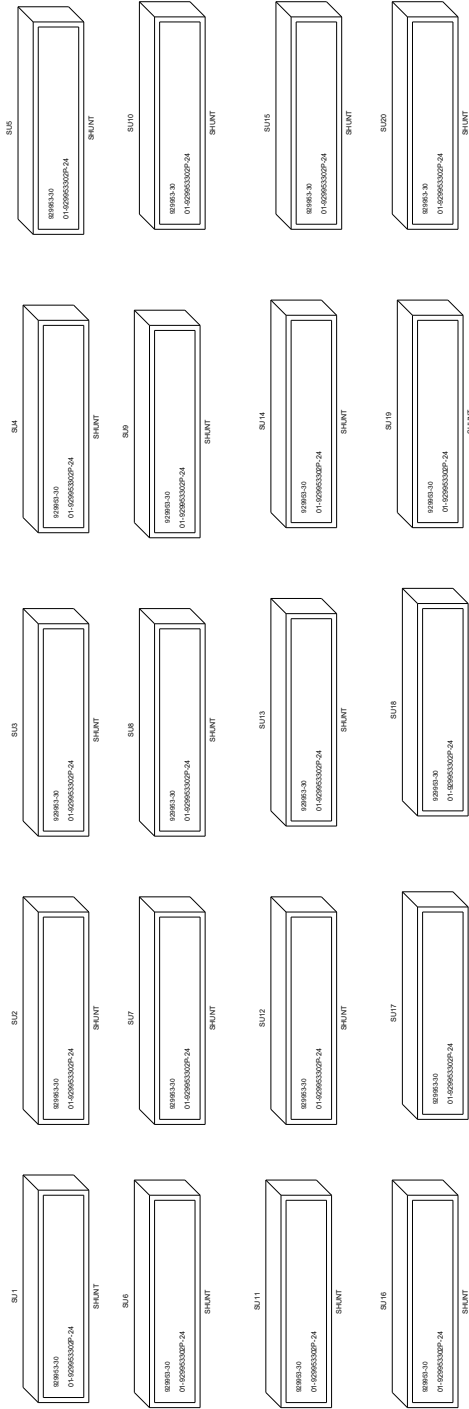

STAND OFF

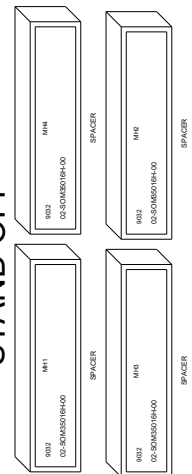

MAX20361 EV Kit Schematics (continued)

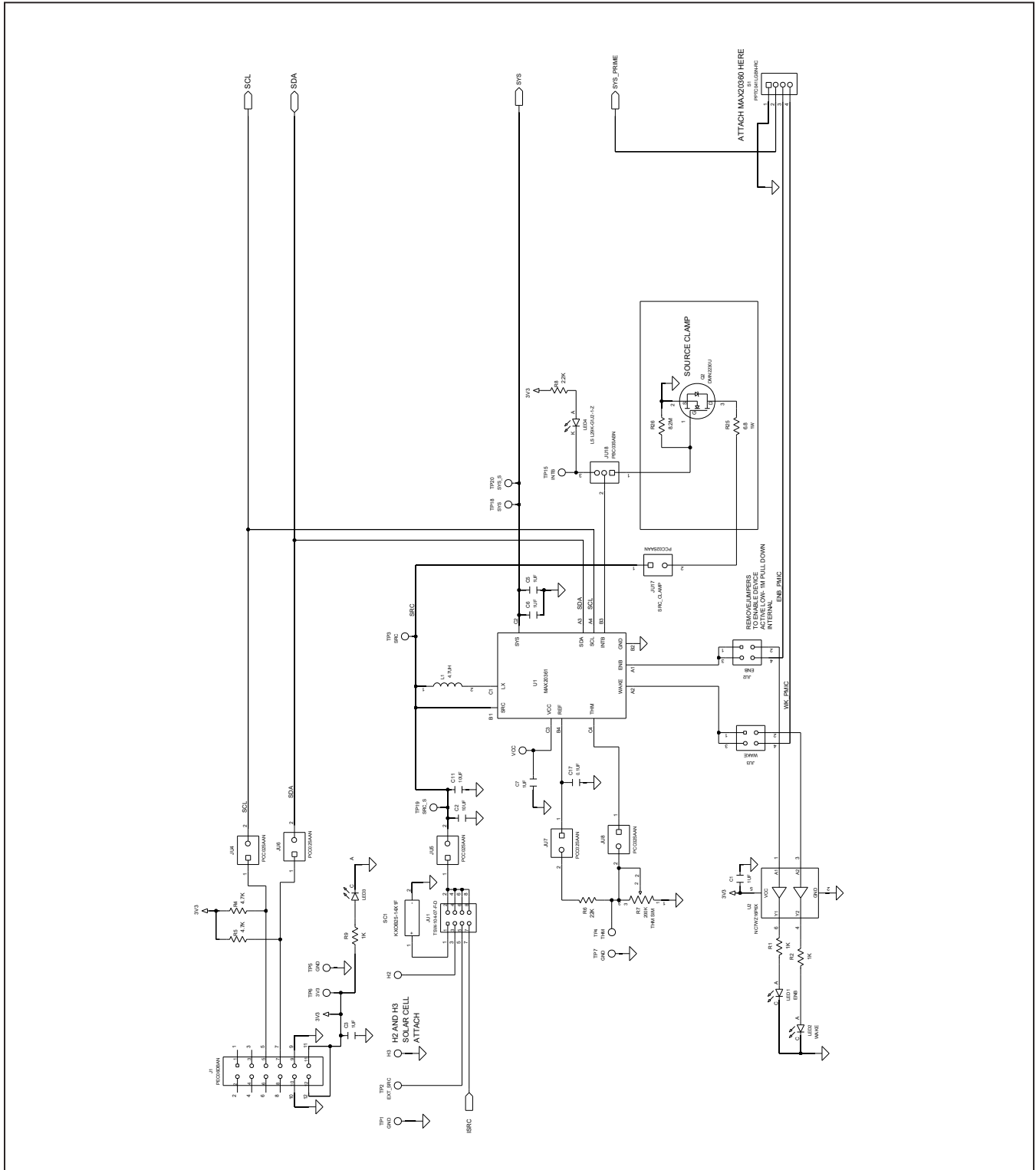

MAX20361 EV Kit Schematics (continued)

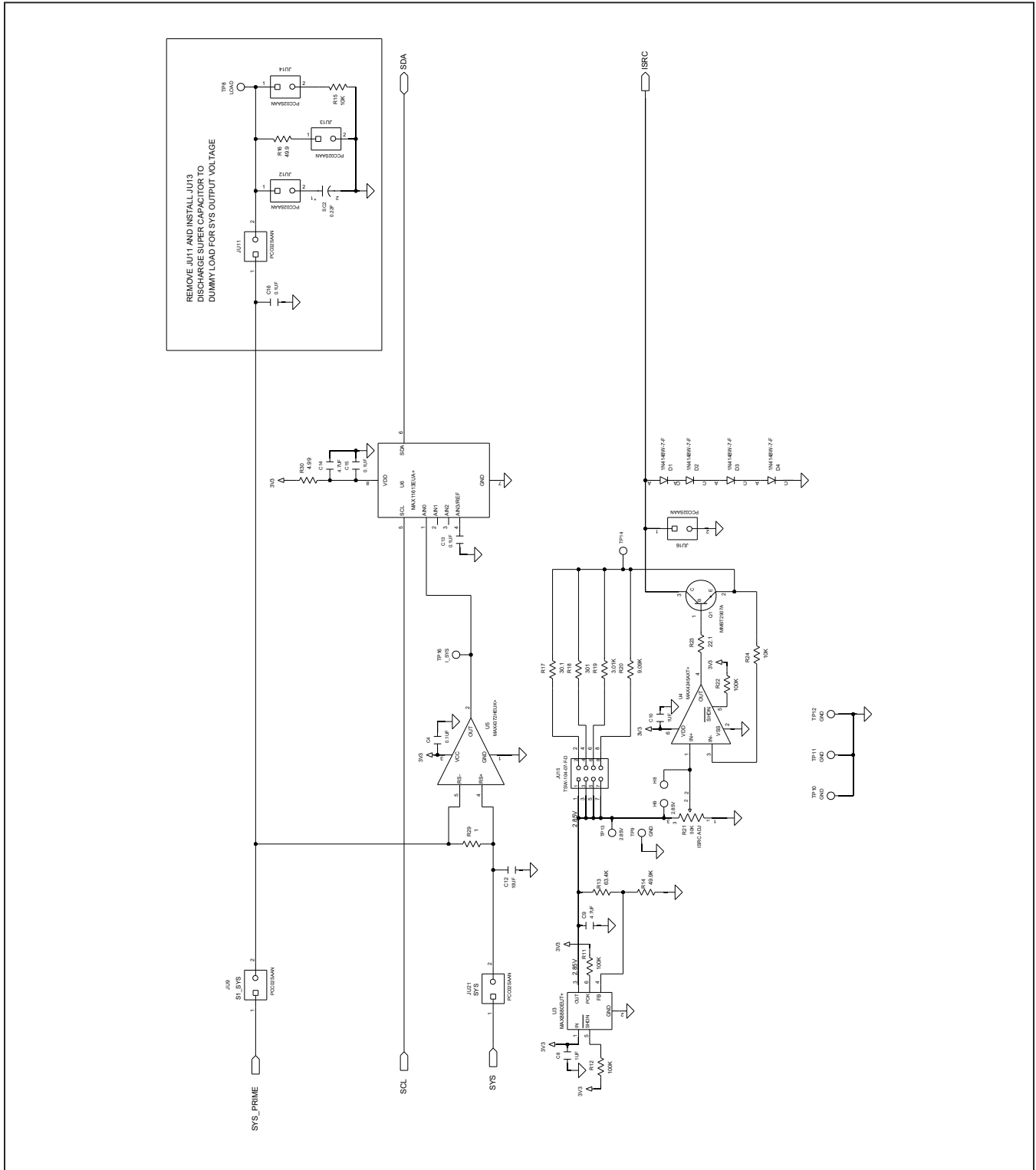

MAX20361 EV Kit PCB Layouts

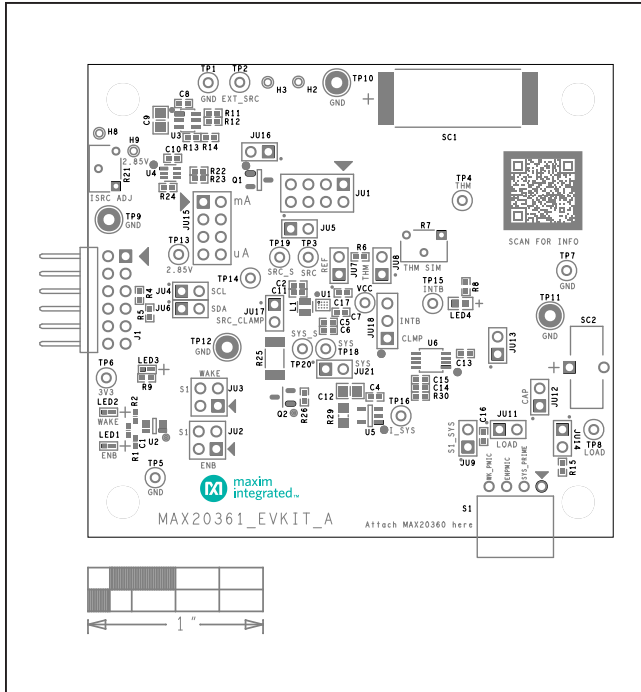

MAX20361 EV Kit Component Placement Guide—Top Silkscreen

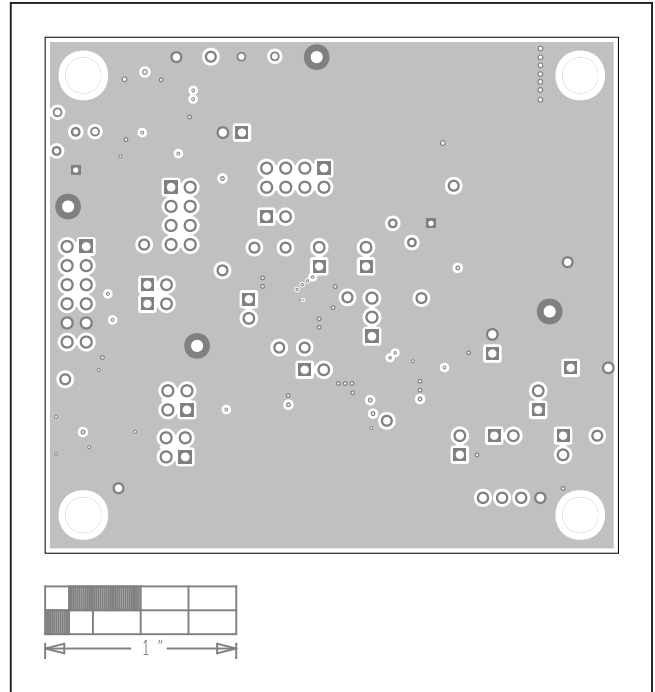

MAX20361 EV Kit PCB Layout—Internal Layer2

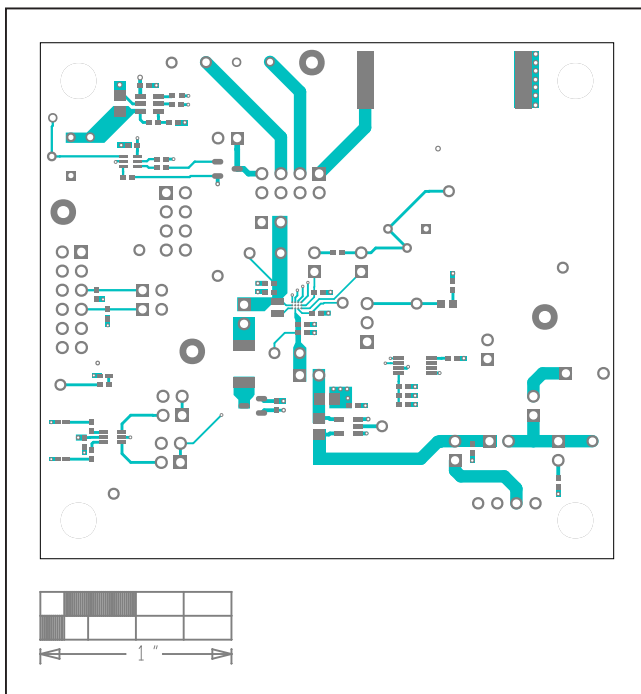

MAX20361 EV Kit PCB Layout—Top Layer

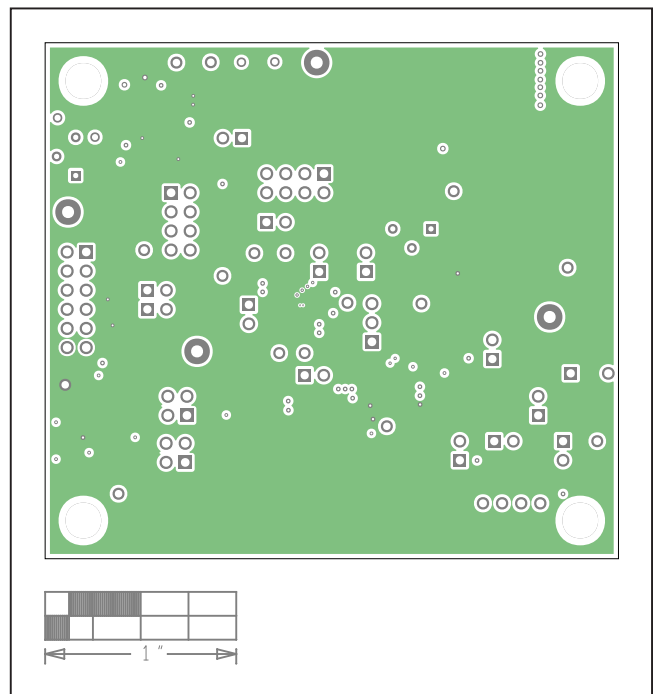

MAX20361 EV Kit PCB Layout—Internal Layer3

MAX20361 EV Kit PCB Layouts (continued)

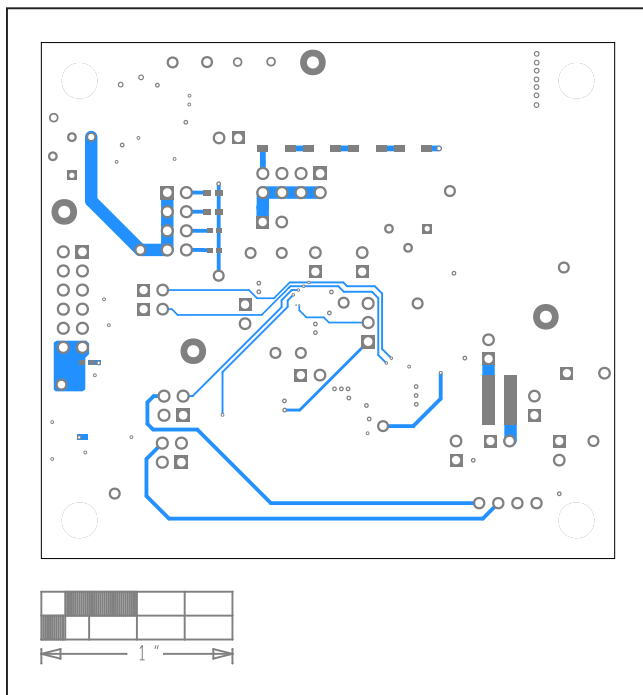

MAX20361 EV Kit PCB Layout—Bottom Layer

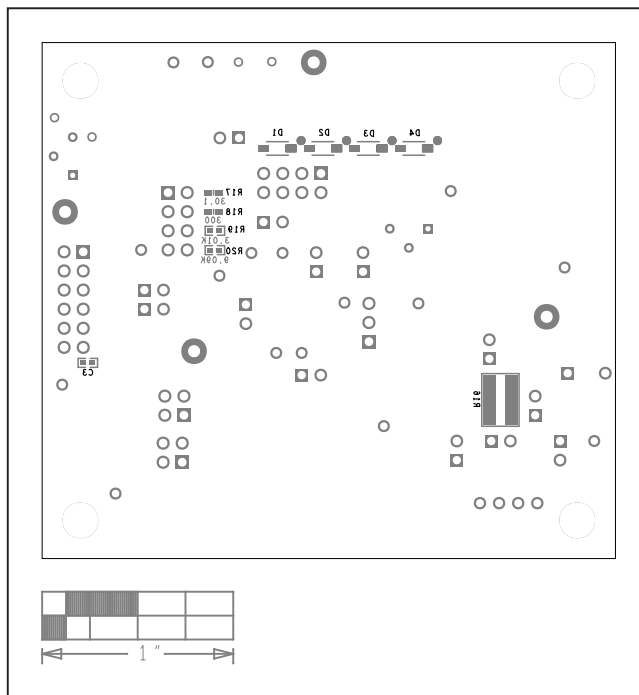

MAX20361 EV Kit PCB Layout—Bottom Components

### Revision History

REVISION NUMBER	REVISION DATE	DESCRIPTION	PAGES CHANGED
0	8/20	Initial release	—

For pricing, delivery, and ordering information, please visit Maxim Integrated's online storefront at <https://www.maximintegrated.com/en/storefront/storefront.html>.

*Maxim Integrated cannot assume responsibility for use of any circuitry other than circuitry entirely embodied in a Maxim Integrated product. No circuit patent licenses are implied. Maxim Integrated reserves the right to change the circuitry and specifications without notice at any time.*

## X-ON Electronics

Largest Supplier of Electrical and Electronic Components

*Click to view similar products for [Power Management IC Development Tools](#) category:*

*Click to view products by [Maxim](#) manufacturer:*

Other Similar products are found below :

[EVB-EP5348UI](#) [MIC23451-AAAYFL EV](#) [MIC5281YMME EV](#) [124352-HMC860LP3E](#) [DA9063-EVAL](#) [ADP122-3.3-EVALZ](#) [ADP130-0.8-EVALZ](#) [ADP130-1.8-EVALZ](#) [ADP1740-1.5-EVALZ](#) [ADP1870-0.3-EVALZ](#) [ADP1874-0.3-EVALZ](#) [ADP199CB-EVALZ](#) [ADP2102-1.25-EVALZ](#) [ADP2102-1.875EVALZ](#) [ADP2102-1.8-EVALZ](#) [ADP2102-2-EVALZ](#) [ADP2102-3-EVALZ](#) [ADP2102-4-EVALZ](#) [AS3606-DB](#) [BQ25010EVM](#) [BQ3055EVM](#) [ISLUSBI2CKIT1Z](#) [LP38512TS-1.8EV](#) [EVAL-ADM1186-1MBZ](#) [EVAL-ADM1186-2MBZ](#) [ADP122UJZ-REDYKIT](#) [ADP166Z-REDYKIT](#) [ADP170-1.8-EVALZ](#) [ADP171-EVALZ](#) [ADP1853-EVALZ](#) [ADP1873-0.3-EVALZ](#) [ADP198CP-EVALZ](#) [ADP2102-1.0-EVALZ](#) [ADP2102-1-EVALZ](#) [ADP2107-1.8-EVALZ](#) [ADP5020CP-EVALZ](#) [CC-ACC-DBMX-51](#) [ATPL230A-EK](#) [MIC23250-S4YMT EV](#) [MIC26603YJL EV](#) [MIC33050-SYHL EV](#) [TPS60100EVM-131](#) [TPS65010EVM-230](#) [TPS71933-28EVM-213](#) [TPS72728YFFEVM-407](#) [TPS79318YEQEVM](#) [UCC28810EVM-002](#) [XILINXPWR-083](#) [LMR22007YMINI-EVM](#) [LP38501ATJ-EV](#)