

General Description

The MAX20800 family of Cell-String Optimizers enables cell-string Maximum Power Point Tracking (MPPT), providing superior photovoltaic (PV) module energy harvest and reliability as compared to both standard panels and those incorporating module level MPPT technologies.

Photovoltaic cells can only deliver maximum power under specific electrical conditions that vary significantly with exposed irradiance and temperature. Series connections of PV cells creates a significant sensitivity to cell mismatch, resulting in less than optimal power and energy production under real-world conditions. The MAX20800 Cell-String Optimizer enables a string of PV cells to deliver their collective maximum power into a wide range of load conditions. This enhanced electrical flexibility eliminates power loss from mismatch in PV strings and arrays, ultimately improving energy production and system design flexibility.

Additional unique advantages provided by the Cell-String Optimizers:

- Reduction in performance degradation over the PV module operating lifetime
- Elimination of high losses associated with bypass diode conduction
- Limit the operating voltage of the PV module

Benefits and Features

- Performs MPPT on 20-24 Series Connected PV Cells
- Fast MPPT Reacts Quickly to Changing Conditions
- Integrated Voltage-Limiting Clamps Output Voltage
- Integrated Current-Limiting Clamps Output Current
- Active Bypass function eliminates diodes and hot-spots
- Supports Panel Flash and Electroluminescence (EL) Testing
- Peak 99.1%, CEC 98.7% and Euro 98.3% Efficiency

Ordering Information appears at end of data sheet.

MAX20800 Cell-String Optimizer Embedded in 60-Cell PV Panel

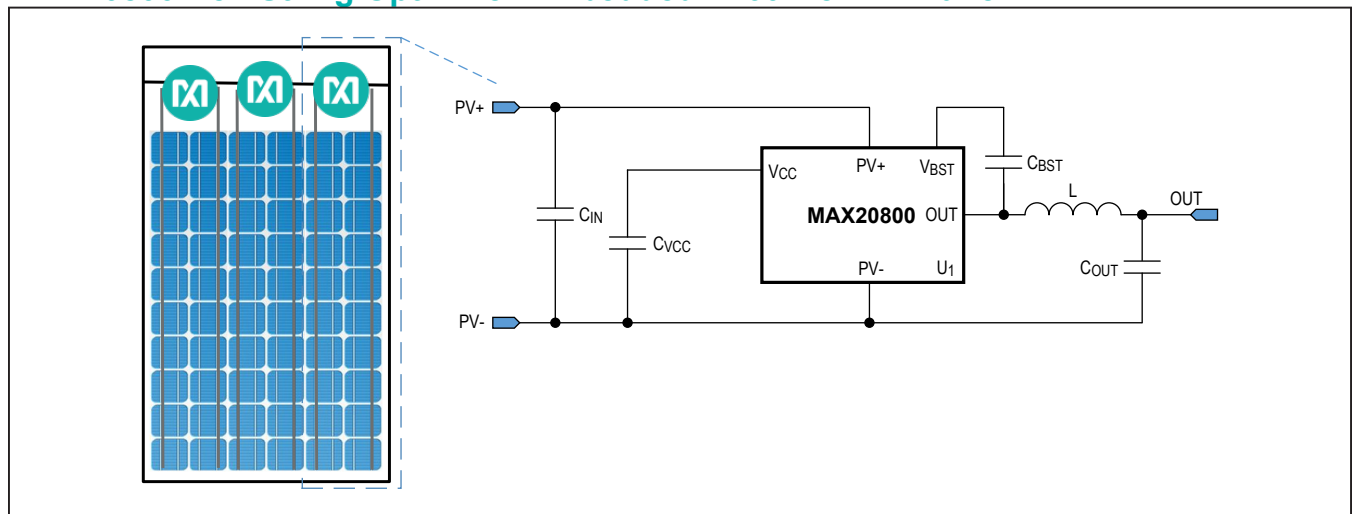

Absolute Maximum Ratings

Input Voltage (PV+).....	-0.3V ~ 21V	Junction Temperature (T _J).....	+150°C
Output Voltage (DC).....	-0.3V ~ 21V	IC Junction Temperature (2hrs) (Note 1)	+200°C
Output Voltage (25ns)	-6V ~ 25V	Storage Temperature Range	-65°C to +150°C
Peak Current (OUT).....	±25A	Peak Reflow Temperature	+260°C

Stresses beyond those listed under “Absolute Maximum Ratings” may cause permanent damage to the device. These are stress ratings only, and functional operation of the device at these or any other conditions beyond those indicated in the operational sections of the specifications is not implied. Exposure to absolute maximum rating conditions for extended periods may affect device reliability.

Operating Ratings

Input Voltage (V _{PV+})	1.5V to 18V
Output Current (I _{OUT})	-4A to 12A
Junction Temperature (T _J).....	-40°C to 150°C

Package Information

PACKAGE CODE: 10FCQFN	
Package Code	P105A3F+1
Outline Number	21-100119
Land Pattern Number	90-100039
THERMAL RESISTANCE, FOUR-LAYER BOARD	
Junction to Case (θ _{JC} MAX)	1°C/W

For the latest package outline information and land patterns (footprints), go to www.maximintegrated.com/packages. Note that a “+”, “#”, or “-” in the package code indicates RoHS status only. Package drawings may show a different suffix character, but the drawing pertains to the package regardless of RoHS status.

Package thermal resistances were obtained using the method described in JEDEC specification JESD51-7, using a four-layer board. For detailed information on package thermal considerations, refer to www.maximintegrated.com/thermal-tutorial.

Note 1: IC Junction Temperature can reach 200°C for a limited duration of two hours as in accordance with IEC61730 and UL1703 testing requirements.

Electrical Characteristics

Typical values are at $T_A = +25^\circ\text{C}$. V_{PV+} connected to 20 series-connected PV cells, unless otherwise noted. (Note 2)

PARAMETER	SYMBOL	CONDITIONS	MIN	TYP	MAX	UNITS
Input Voltage Range for MPPT	V_{PV+}		6.5		15.5	V
Input Quiescent Current	I_{PV+}	Open circuit		75		mA
		Active bypass		7		
Output-Current Limiting	$I_{OUT(MAX)_MPP}$	MAX20800T / MAX20800TA, max sourcing current for MPPT mode		10.6		A
		MAX20800TB, max sourcing current for MPPT mode		11.2		
	$I_{OUT(MAX)}$	MAX20800T / MAX20800TA, max sourcing current		11.3	12.0	
		MAX20800TB, max sourcing current		11.9	12.6	
	$I_{OUT(MAX)_SC}$	Max sourcing current with $OUT+ < 1V$		4.0		
Output-Voltage Limiting	$V_{MP(MAX)}$	MAX20800T, 10A output		10.7		V
		MAX20800TA, 10A output		12.6		
		MAX20800TB, 10A output		11.1		
	$V_{OC(MAX)}$	MAX20800T, open circuit		11.7		
		MAX20800TA, open circuit		13.6		
		MAX20800TB, open circuit		11.3		
Bypass-Voltage Drop (Note 3)	V_{BYPASS}	$PV_+ = 1.5V$, $I_{OUT} = 12A$		120		mV
Overtemperature Threshold	$T_{SHUTDOWN}$	MPPT enable		130		$^\circ\text{C}$
		MPPT disable		150		
Duty-Cycle Range	D		0		100	%
MPPT Loop Response Time	t_{MPPT}			0.4		ms
MPPT Efficiency	η_{MPPT}	$I_{OUT} = 8A$		99.9		%

Note 2: Limits are 100% tested at $T_A = 32^\circ\text{C}$. Limits over the operating temperature range and relevant supply voltage range are guaranteed by design and characterization.

Note 3: Using the standard Maxim Evaluation Kit.

Typical Operating Characteristics

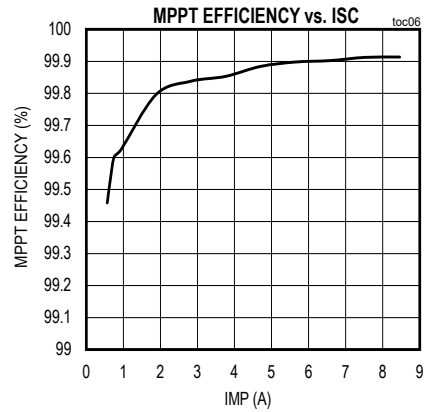
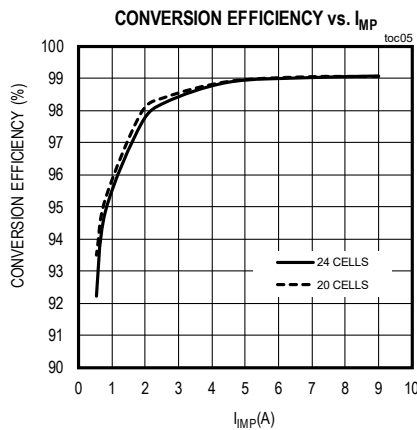
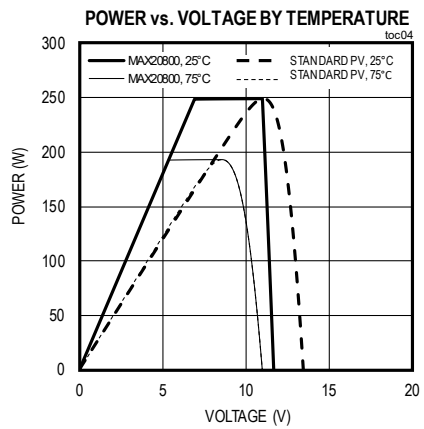
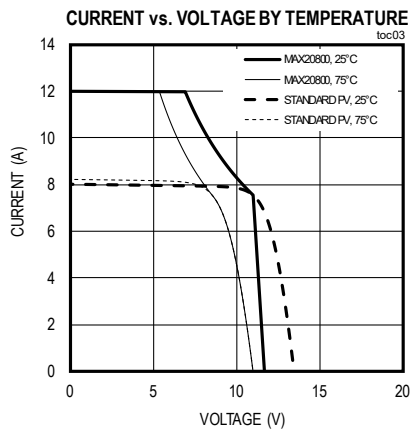
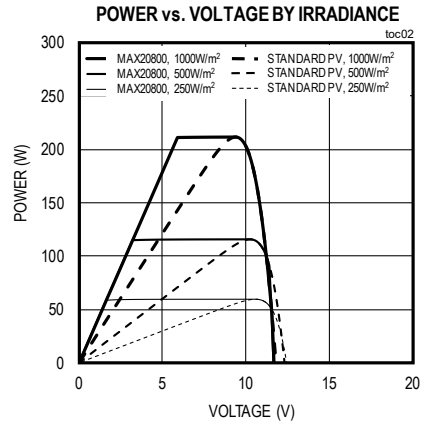
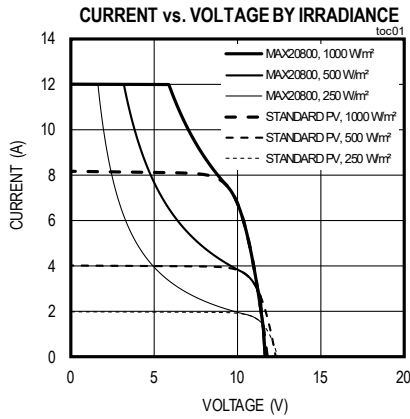

Pin Configuration

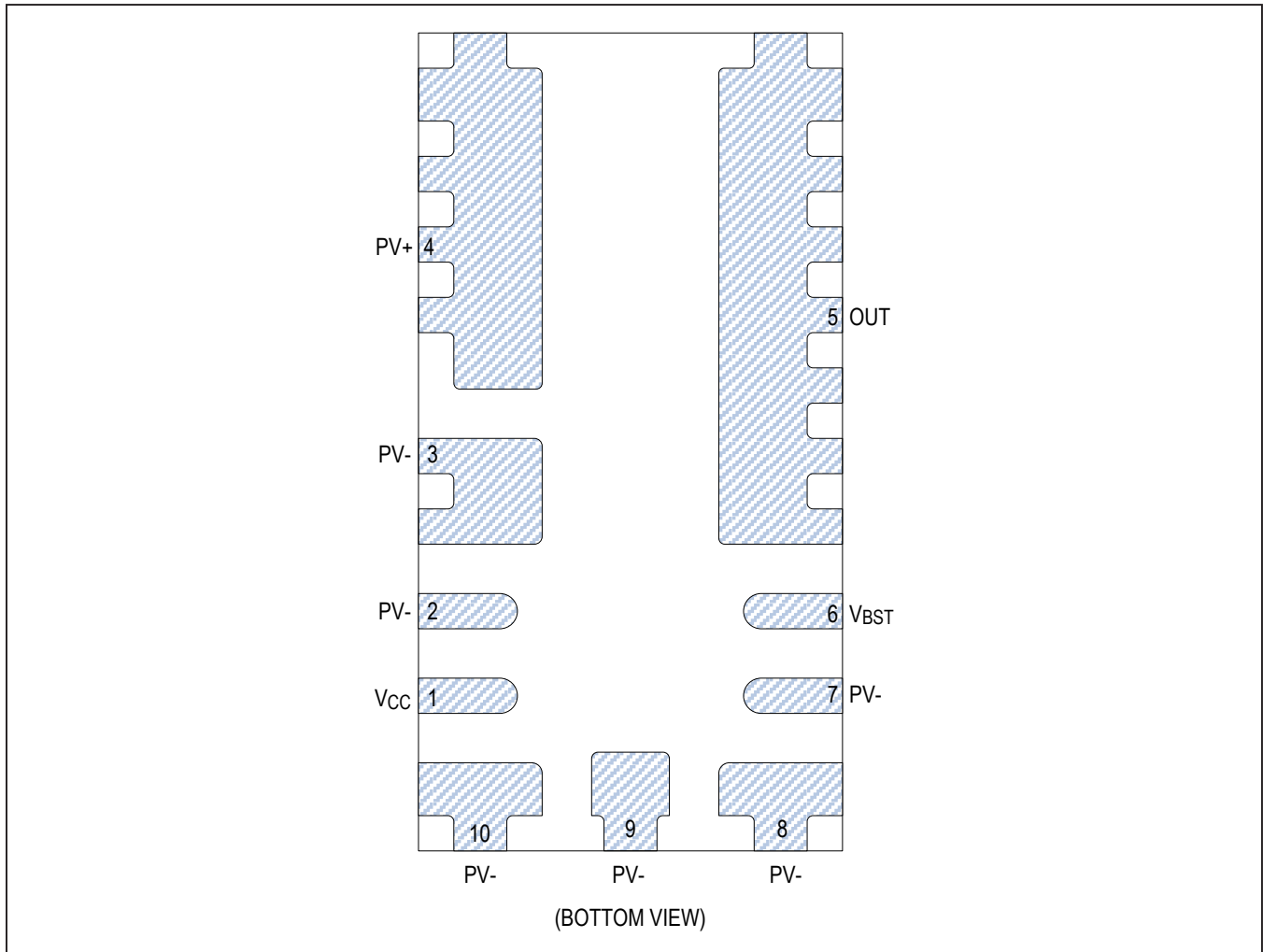

Pin Description

PIN	NAME	FUNCTION
1	V _{CC}	Internal Power Supply
2-3, 7-10	PV-	PV Negative Power Input and Control Ground
4	PV+	PV Positive Power Input
5	OUT	MPPT Output
6	V _{BST}	Internal Power Supply

Detailed Description

Maximum Power Point Tracking (MPPT)

In the Maximum Power Point Tracking (MPPT) mode of operation, the Cell-String Optimizer devices replace bypass diodes while performing the MPPT function on an isolated group of series connected PV cells (cell-string). Each cell-string operates at its own unique maximum power point regardless of the operating point of other cell-strings in the same PV module or series string of modules.

“Voltage vs. Current by Irradiance” (TOC01) depicts the electrical characteristics of a cell-string when operating both with and without the MAX20800 device, under three different irradiance conditions. Conventional cell-strings are limited by their ability to deliver maximum power at a single current and voltage (IMP and VMP, respectively) that are directly related to irradiance and temperature. Cell-strings optimized with the MAX20800 can arbitrarily scale their output current higher with a proportional reduction in output voltage. The additional degree of freedom afforded by this functionality enables maximum power delivery regardless of the string current set by the inverter. This concept is clearly depicted in “Voltage vs. Power by Irradiance,” (TOC02) where it can be seen that optimized cell-strings deliver constant power for any current equal or larger than the IMP of the cell-string.

The MAX20800 performs this isolating DC-DC converter function with monolithic Power FETs, in a synchronous buck converter topology, that are fully integrated alongside precision control circuitry. MPPT is performed with a “perturb and observe” algorithm that is both extremely fast and accurate. The maximum power point is tracked with a typical effectiveness of 99.9% and a fast sampling speed, allowing maximal energy recovery when exposed to fast moving clouds or obstruction shading.

Electronic Voltage Limiting

The MAX20800 isolates PV cells from the PV module output terminals with a synchronous DC-DC converter in a buck topology. As such, the maximum output voltage of the PV module can be independently limited in voltage while the PV cells themselves continue to operate at their natural maximum power voltage.

The output voltage of the PV module is electronically limited and independent of irradiance and temperature, guaranteeing a single output voltage that is safe for PV system maximum voltage calculations under all operating conditions. Refer to the [Electrical Characteristics](#) table for detailed voltage-limiting specifications.

Electronic Current Limiting

The MAX20800 devices are designed to work with all mainstream PV cell technologies. In order to ensure proper MPPT operation, the PV cell maximum power current should remain below the maximum value indicated in the [Electrical Characteristics](#) table. If this range is exceeded, the device no longer extracts maximum power, resulting in performance loss during these conditions.

The output current sourced by the PV module is electronically limited and independent of irradiance and temperature, guaranteeing a single output current that is safe for PV system maximum current calculations under all operating conditions. Refer to the [Electrical Characteristics](#) table for detailed current limiting specifications.

Active Bypass

Under extremely low irradiance and other atypical conditions, MPPT operation is not possible and the device reverts to Active Bypass mode of operation. In Active Bypass, the low-side power FET remains enabled so that external current can pass through a low resistance connection from the PV- to OUT pins of the device. Additionally, the high-side power FET remains disabled so that the cell-string operates in the open-circuit condition instead of in reverse breakdown (as is typical with conventional bypass schemes). The MAX20800’s active bypass mode delivers a lower-loss bypass methodology that also actively prevents PV cell hot-spots, eliminating thermal stress and possible subsequent wear-out or degradation.

Conditions under which the device reverts to Active Bypass mode:

- Undervoltage detection on PV+ input.
- String current exceeding the electronic current limit.
- IC temperature exceeding the internal temperature protection limit.

Reverse Current

When the OUT pin is exposed to reverse currents, the MAX20800 device enters the Reverse Current mode of operation. While in this operating mode, the MPPT function is disabled and the DC-DC converter operates at a maximum duty cycle to pass the reverse current directly back into the PV cells. Therefore, most of the power delivered by the reverse current power source is absorbed by the series-connected PV cells, as is the case with conventional PV modules.

The Reverse Current mode of operation is seamlessly entered and exited as external conditions demand. Consequently, electroluminescence and other reverse current tests are supported without any changes to standard testing procedures. As the output current reverts to a positive direction, MPPT operation automatically resumes.

Flash Test Mode

The current-voltage curve of an MPPT-enabled PV module differs significantly from that of a conventional module. Additionally, typical flash test sweeps are performed at a rate faster than the MAX20800 MPPT response time. For both of these reasons, the full MPPT enabled output characteristics of a MAX20800 enabled PV module would not be observable by most flash test equipment.

In order to support production QA flash testing, the MAX20800 devices have a special flash test mode of operation. While in this mode, the DC-DC converter does not perform MPPT but rather operates at the maximum duty cycle resulting in flash test curve measurements similar to those of the conventional PV modules.

In order to successfully flash test MAX20800 enabled panels, two important conditions must be met.

- 1) All ambient light must be eliminated before the flash test begins.
- 2) The flash tester must sweep the panel voltage in the direction of open circuit to short circuit.

If these two conditions are met, the MAX20800 enabled panels can undergo industry standard flash testing. In particular, the first condition is a function of the panel manufacturer's flash testing setup. The second condition is typically supported by the flash test hardware manufacturer by means of software programmable options.

Contact a Maxim representative for further details.

PV System Design Considerations

PV modules incorporating the MAX20800 family of MPPT devices operate much like conventional modules, albeit with electronically limited output currents and voltages, improved energy harvest and enhanced reliability characteristics. Photovoltaic system design is very similar to that of conventional systems.

- Maximum modules per string can be easily calculated by dividing the maximum system voltage or maximum MPPT window voltage of the inverter by the electronically limited maximum output voltage of the PV module. The electronic-voltage limiting is not impacted by irradiance or temperature, so no derating factors are needed or recommended.
- Maximum source current per module is electronically limited, so all DC conductors, fuses, and inverter inputs can be rated with a single derating factor of $1.25 \times I_{OUT_MAX}$. The selection of I_{OUT_MAX} is carefully chosen to enable a 15A series fuse ratings for the PV module (see [Electrical Characteristics](#) table).
- MAX20800 enabled PV modules are compatible with standard commercial grid-tie inverters. Some inverters offer a "Global Sweep" function that periodically takes the system off-MPP to sweep across the entire acceptable voltage range and ensure the inverter is not operating at a local (false) MPP point. It is possible to disable the Global Sweep function, maximizing operating time at MPP and, therefore, increasing the energy harvest.

Ordering Information

PART	TEMP RANGE	PIN-PACKAGE
MAX20800TPB+	-40°C to +150°C	10 FCQFN
MAX20800TPB+T	-40°C to +150°C	10 FCQFN
MAX20800TPBA+	-40°C to +150°C	10 FCQFN
MAX20800TPBA+T	-40°C to +150°C	10 FCQFN
MAX20800TPBB+	-40°C to +150°C	10 FCQFN
MAX20800TPBB+T	-40°C to +150°C	10 FCQFN

+Denotes a lead(Pb)-free/RoHS-compliant package.
T= Tape and reel.

Revision History

REVISION NUMBER	REVISION DATE	DESCRIPTION	PAGES CHANGED
0	6/16	Initial release	—
1	4/17	Updated <i>Benefits and Features</i> and <i>Absolute Maximum Ratings</i> sections; <i>Electrical Characteristics</i> table and <i>Typical Operating Characteristics</i> 1-5; <i>MAX20800 Cell-String Optimizer Embedded in 60-Cell PV Panel</i> figure, <i>Pin Configuration</i> , <i>Pin Description</i> table, <i>Electronic Current Limiting</i> section, and <i>Ordering Information</i> .	1–6, 8
2	11/17	Updated <i>Absolute Maximum Ratings</i> sections, <i>Electrical Characteristics</i> table, and <i>Ordering Information</i> .	2–3, 5, 8
3	12/17	Updated the <i>Ordering Information</i> table.	8
4	2/18	Updated the <i>Electrical Characteristics</i> table.	3

For information on other Maxim Integrated products, visit Maxim Integrated's website at www.maximintegrated.com.

Maxim Integrated cannot assume responsibility for use of any circuitry other than circuitry entirely embodied in a Maxim Integrated product. No circuit patent licenses are implied. Maxim Integrated reserves the right to change the circuitry and specifications without notice at any time. The parametric values (min and max limits) shown in the *Electrical Characteristics* table are guaranteed. Other parametric values quoted in this data sheet are provided for guidance.

X-ON Electronics

Largest Supplier of Electrical and Electronic Components

Click to view similar products for [Switching Voltage Regulators](#) category:

Click to view products by [Maxim](#) manufacturer:

Other Similar products are found below :

[FAN53610AUC33X](#) [FAN53611AUC123X](#) [FAN48610BUC33X](#) [FAN48610BUC45X](#) [FAN48617UC50X](#) [R3](#) [430464BB](#) [KE177614](#)
[MAX809TTR](#) [NCV891234MW50R2G](#) [NCP81103MNTXG](#) [NCP81203PMNTXG](#) [NCP81208MNTXG](#) [NCP81109GMNTXG](#)
[SCY1751FCCT1G](#) [NCP81109JMNTXG](#) [AP3409ADNTR-G1](#) [LTM8064IY](#) [LT8315EFE#TRPBF](#) [NCV1077CSTBT3G](#) [XCL207A123CR-G](#)
[MPM54304GMN-0002](#) [MPM54304GMN-0003](#) [XDPE132G5CG000XUMA1](#) [DA9121-B0V76](#) [LTC3644IY#PBF](#) [MP8757GL-P](#)
[MIC23356YFT-TR](#) [LD8116CGL](#) [HG2269M/TR](#) [OB2269](#) [XD3526](#) [U6215A](#) [U6215B](#) [U6620S](#) [LTC3803ES6#TR](#) [LTC3803ES6#TRM](#)
[LTC3412IFE](#) [LT1425IS](#) [MAX25203BATJA/VY+](#) [MAX77874CEWM+](#) [XC9236D08CER-G](#) [ISL95338IRTZ](#) [MP3416GJ-P](#) [BD9S201NUX-](#)
[CE2](#) [MP5461GC-Z](#) [MPQ4415AGQB-Z](#) [MPQ4590GS-Z](#) [MCP1642B-18IMC](#) [MCP1642D-ADJIMC](#)