

MAX20800 Evaluation Kit

Evaluates: MAX2080, MAX20801

General Description

The MAX2080XXEVKIT# family of evaluation kits (EV kits) serve as a reference platform for evaluating the MAX20800 and MAX20801 maximum power point tracking (MPPT) ICs. These single-chip, integrated switching regulators provide an extremely compact, low cost, highly efficient, fast, accurate and reliable power delivery solution for photovoltaic (PV) modules. Refer to the MAX20800 and MAX20801 IC data sheets for more information.

The EV kit comprises a fully-assembled and tested PCB implementation of the MAX20800. Input and output connectors for three photovoltaic cell strings are included for flexibility and ease-of-use with standard 60 or 72-cell crystalline PV modules.

Features

- Performs MPPT on three sets of 20–24 Series-Connected PV Cells
- Fast MPPT Reacts Quickly to Changing Conditions
- Small 3,800mm² Solution Size
- Integrated Voltage-Limiting Clamps Output Voltage
- Integrated Current-Limiting Clamps Output Current
- Active Bypass Function Eliminates Hot Spots
- Supports Flash and EL Testing
- Peak 99.1%, CEC 98.7%, and Euro 98.3% Efficiency
- Proven PCB Layout
- Fully Assembled and Tested

Quick Start

Required Equipment

- MAX20800 EV kit
- Six-busbar PV module
- Electronic load
- Multimeters

Procedure for One Cell String

The EV kit is fully assembled and tested. Follow the steps below to verify board operation:

- 1) Connect the positive and negative terminals of a single cell string to PV1+ and PV1- terminals of the EV kit.
- 2) Connect the positive terminal of the load to PV2- and the negative terminal of the load to OUT-.
- 3) Expose the PV module to steady state irradiance, either by an indoor light table or in outdoor conditions.
- 4) It is important to ensure the proper connection polarity of the PV Cells with respect to the physical PCB terminal connectors, see [Testing Configuration](#) diagrams.

[Ordering Information](#) appears at end of data sheet.

PRELIMINARY

Procedure for Three Cell Strings

Connecting all three cell strings from a PV Module to the EV kit requires a six-busbar module, whereby the two electrical connections between the three cell strings are intentionally left independent. If such a PV Module is not available, it is recommended to test one cell string.

To connect a six-busbar module to the EV kit, follow the same procedure as above but connect one cell string to each of the PV1+/PV1-, PV2+/PV2-, and PV3+/PV3- input terminals. Connect the output load the OUT-/OUT+ terminals.

Detailed Description of Hardware

The MAX20800 IC is a monolithic, high-frequency step-down switching regulator optimized for performing MPPT on 20-24 crystalline photovoltaic cells. In order to support the MAX20800 application, PV Modules must be designed with six-busbar connections to the junction box, as opposed to the typical four. Detailed product and application information is provided in the MAX20800 IC data sheet.

Always Enabled

The switching regulator is always enabled so long as power is available on the input pins.

MPPT Tracking

The MAX20800 switching regulator performs MPPT stepping every 0.4ms. This speed is fast enough to present a quasi-static IV curve to standard PV string and panel inverter loads, but not fast enough to operate with typical PV simulator power supplies or flash testers. For this reason, it is encouraged to test the MAX20800 EV kit with the PV module exposed to the steady state irradiance of an indoor light table or on-sun as an input, and an electronic load on the output.

Output Limiting

The output voltage and current are electronically limited by the switching regulator as described in the table below.

IC PART	OUTPUT VOLTAGE LIMIT (V)	OUTPUT CURRENT LIMIT (A)
MAX20800	11.7	11.3
MAX20800A	13.6	11.3
MAX20801A	10.6	11.9
MAX20801B	11.2	11.9
MAX20801C	12.4	11.9

The output IV characteristics are such that maximum output power is delivered into any voltage or current load so long as the output voltage and current limits are not exceeded. If the output voltage exceeds the voltage limit the switching regulator will actively sink current. If the output current exceeds the current limit the cell string will be bypassed by a low-resistance FET.

Meanwhile, the voltage and current capability of the input connected PV cell strings can exceed these output limits but should remain below the maximum input operating conditions specified in the IC data sheet.

Input Voltage and Current

Each cell string input voltage and current can be measured directly at its respective PV+/PV- input terminals. Voltage should be measured directly at the pads with kelvin connections, meanwhile a low resistance (i.e., 1mΩ) shunt should be placed in series with PV+ to measure current. The shunt should be carefully calibrated to minimize measurement errors.

Output Voltage and Current

The output voltage and current can be measured at the OUT-/PV2- terminals while operating a single cell string or OUT-/OUT+ while operating with all three cell strings. Voltage should be measured directly at the pads with kelvin connections, meanwhile a low resistance (i.e., 1mΩ) shunt should be placed in series with the output to measure current. The shunt should be carefully calibrated to minimize measurement errors.

Efficiency Testing

Both power conversion and MPPT efficiency can be tested by comparing the power output to a Reference PV module. In order to avoid the influence of dynamically changing conditions while operating on-sun, it is highly suggested to operate the DUT and Reference modules at the same time with near simultaneous data acquisitions.

MPPT Efficiency can be measured by comparing the input power to the IC to that delivered by the Reference module operating at the MPP condition. The electronic load can be programmed to operate at MPP or perform continual IV sweeps. If performing IV sweeps, it is suggested to dwell at each measurement point for a minimum of 5ms to ensure the IC settles at the new load-dependent operating point.

Carefully note the connection order and polarity of PV input terminals when connecting the cell strings to the EV kit.

PRELIMINARY

Testing Configuration

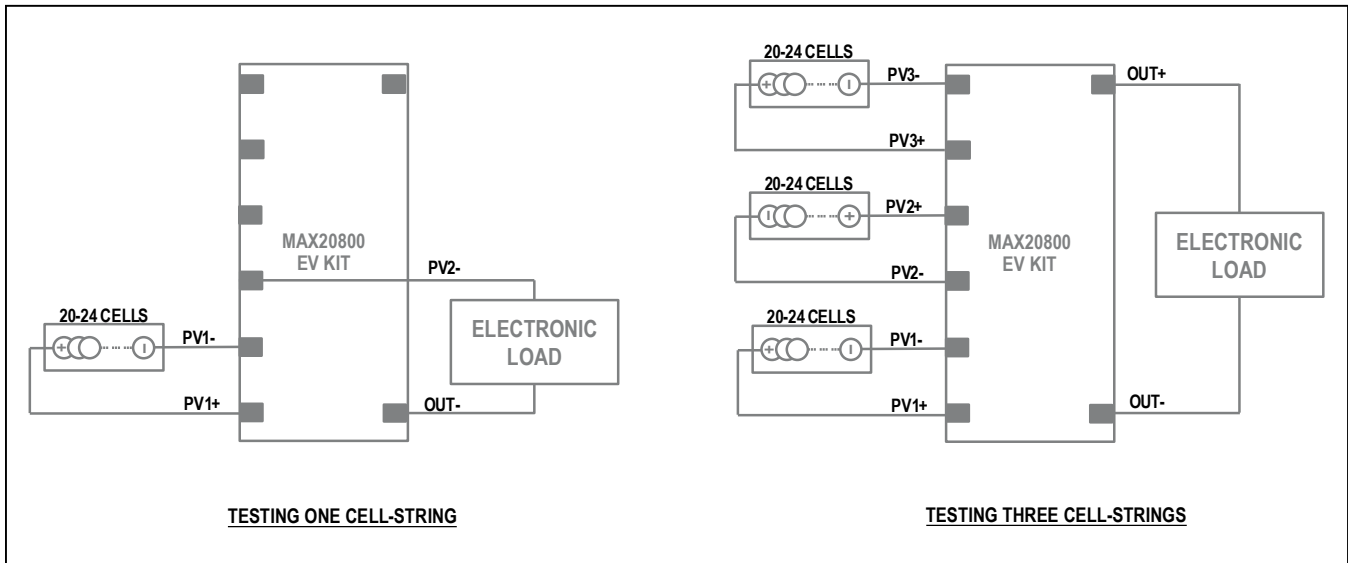

Component List

PART	QTY	DESCRIPTION
U1, U2, U3	3	MAX208000 MPPT Regulation IC
D2	1	SCHOTTKY RECTIFIER, 10A, 200V, POWERDI5
L1, L2, L3	3	POWER INDUCTOR
C21	1	Capacitor, 0.1 μ F, 100V, X7R, 0603
C19, C101, C103, C104, C106-C110, C202-C205, C207-C210, C301-C304, C307-C309, C315-C318, C320, C337	30	Capacitor, 10 μ F \pm 10%, 20%, 25V, X6S, 0805
C111, C211, C311	3	Capacitor, 1.0 μ F \pm 10%, 20%, 6.3V, X6S, 0402

PART	QTY	DESCRIPTION
C112, C212, C312	3	Capacitor, 0.22 μ F \pm 10%, 20%, 6.3V, X6S, 0402
C66-C68, C79, C80, C94, C95, C323, C326, C332, C333, C335	12	Capacitor, 0.1 μ F \pm 10%, 20%, 25V, X7R, 0402
R15	1	Resistor, 10 Ω \pm 5%, 0.1W, 0402
C21	1	Capacitor, 0.1 μ F \pm 10%, 20%, 100V, X7R, 0603
	1	PCB# 35-900368-03-00

Ordering Information

PART	TYPE
MAX20800EVKIT#	EV Kit for MAX20800
MAX20800AEVKIT#	EV Kit for MAX20800A
MAX20801AEVKIT#	EV Kit for MAX20801A
MAX20801BEVKIT#	EV Kit for MAX20801B
MAX20801CEVKIT#	EV Kit for MAX20801C

PRELIMINARY

MAX20800 EV Kit PCB Layout Diagrams

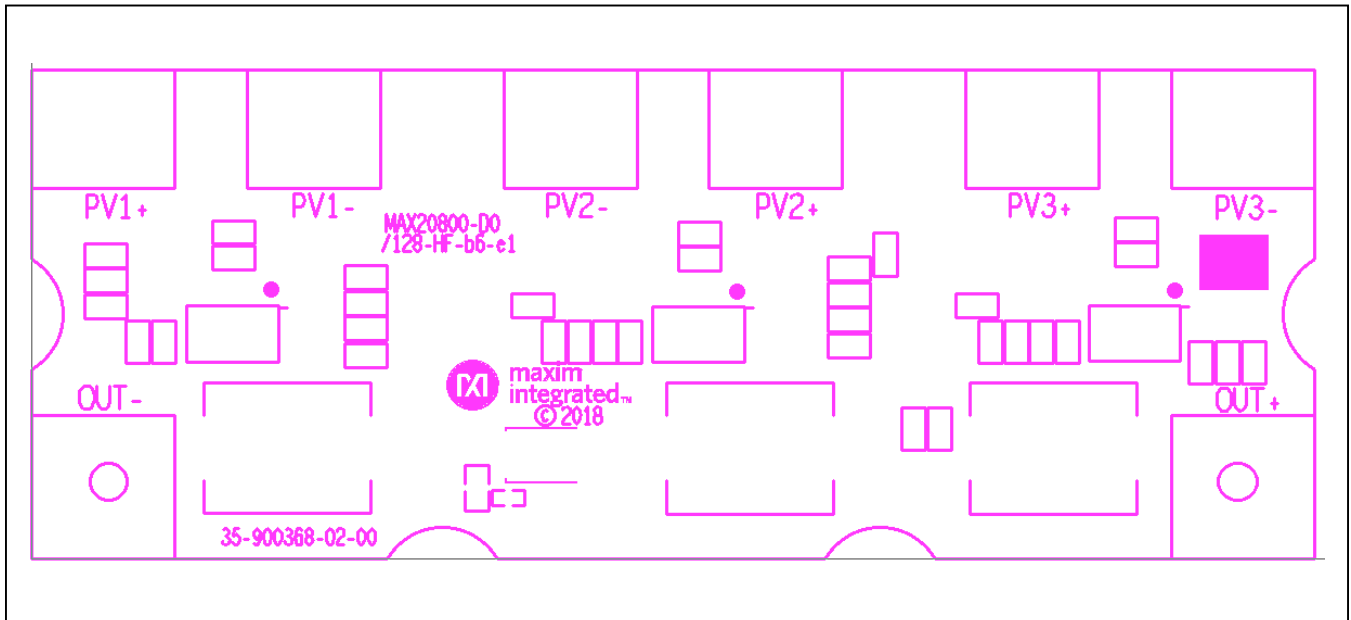

MAX20800 EV Kit—Top Silk Screen

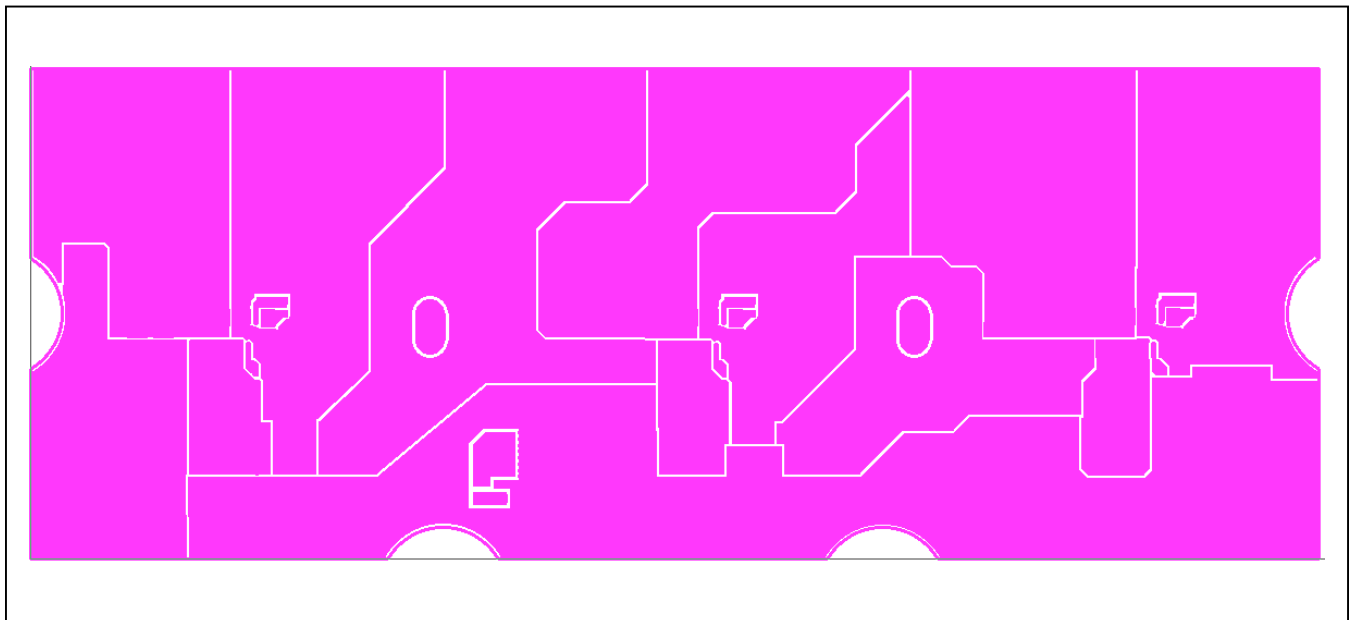

MAX20800 EV Kit—Layer 1

PRELIMINARY

MAX20800 EV Kit PCB Layout Diagrams (continued)

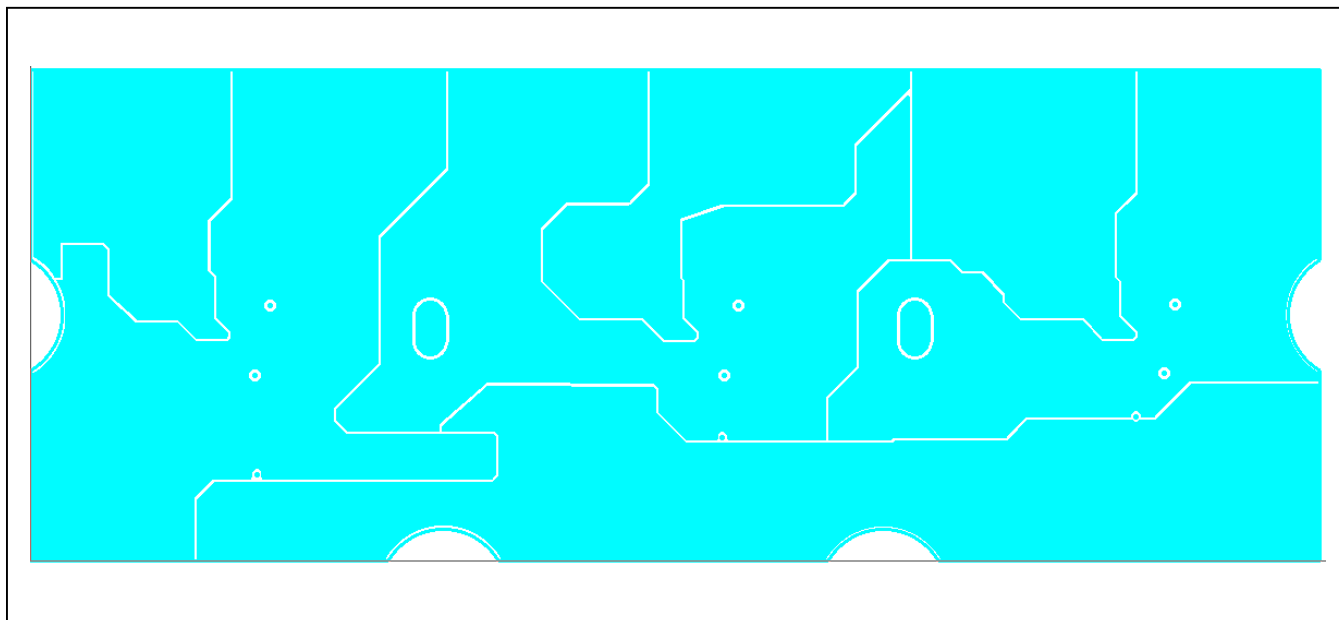

MAX20800 EV Kit—Layer 2

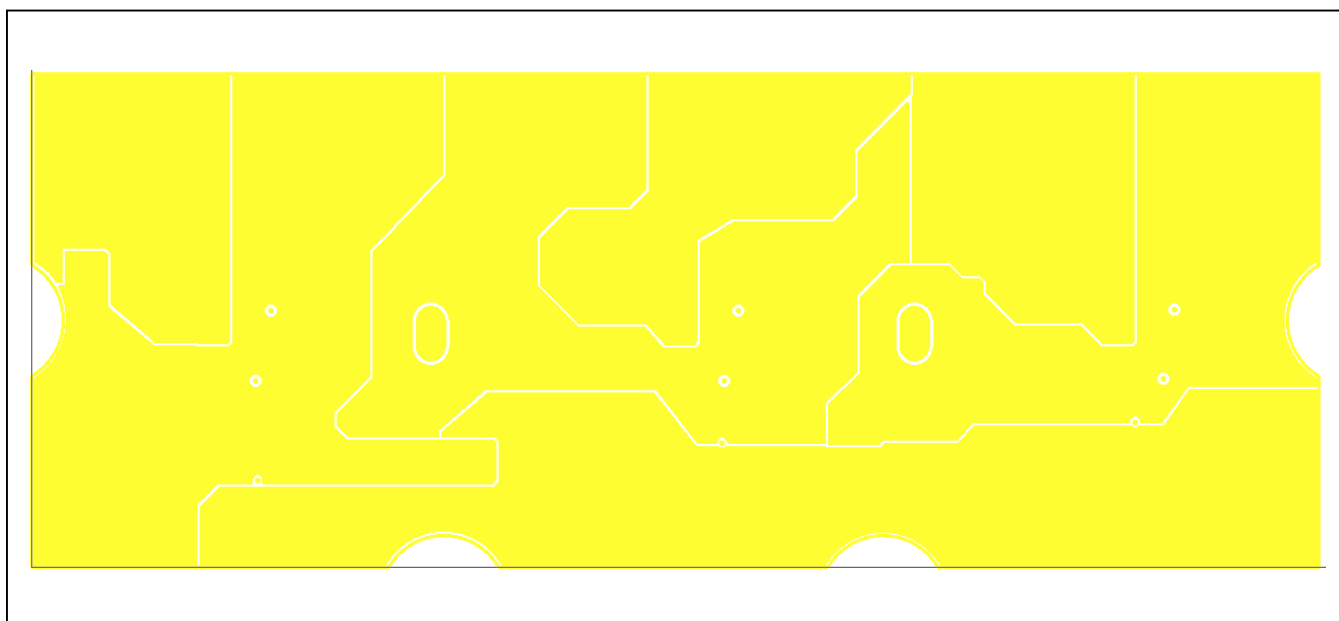

MAX20800 EV Kit—Layer 3

PRELIMINARY

MAX20800 EV Kit PCB Layout Diagrams (continued)

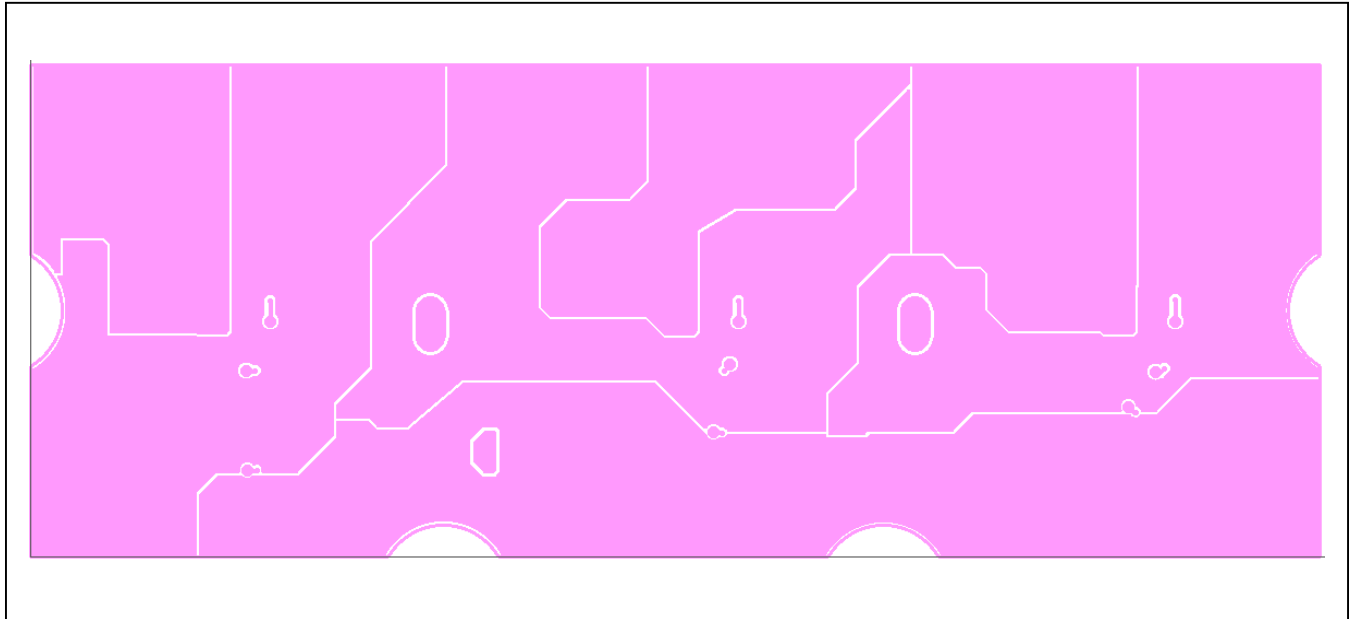

MAX20800 EV Kit—Layer 4

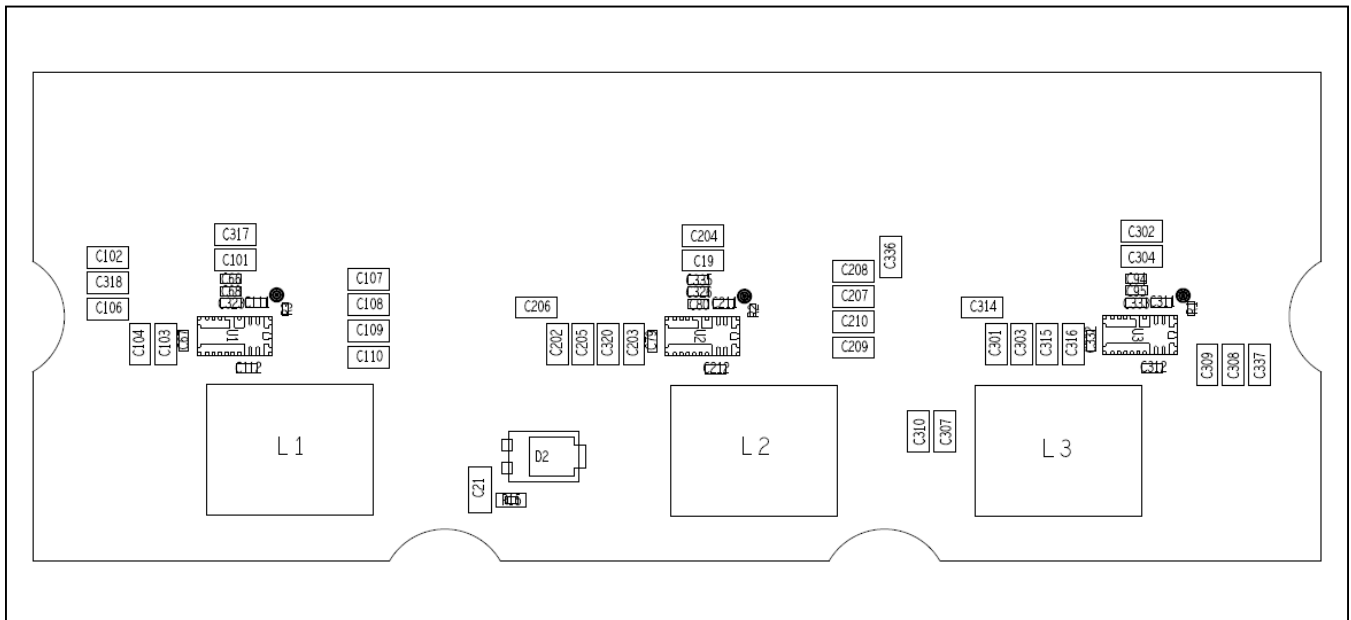

MAX20800 EV Kit—Component Placement

PRELIMINARY

Revision History

REVISION NUMBER	REVISION DATE	DESCRIPTION	PAGES CHANGED
0	2/19	Initial release	—

PRELIMINARY

For pricing, delivery, and ordering information, please visit Maxim Integrated's online storefront at <https://www.maximintegrated.com/en/storefront/storefront.html>.

Maxim Integrated cannot assume responsibility for use of any circuitry other than circuitry entirely embodied in a Maxim Integrated product. No circuit patent licenses are implied. Maxim Integrated reserves the right to change the circuitry and specifications without notice at any time.

X-ON Electronics

Largest Supplier of Electrical and Electronic Components

Click to view similar products for [Power Management IC Development Tools](#) category:

Click to view products by [Maxim](#) manufacturer:

Other Similar products are found below :

[EVB-EP5348UI](#) [MIC23451-AAAYFL EV](#) [MIC5281YMME EV](#) [124352-HMC860LP3E](#) [DA9063-EVAL](#) [ADP122-3.3-EVALZ](#) [ADP130-0.8-EVALZ](#) [ADP130-1.8-EVALZ](#) [ADP1740-1.5-EVALZ](#) [ADP1870-0.3-EVALZ](#) [ADP1874-0.3-EVALZ](#) [ADP199CB-EVALZ](#) [ADP2102-1.25-EVALZ](#) [ADP2102-1.875EVALZ](#) [ADP2102-1.8-EVALZ](#) [ADP2102-2-EVALZ](#) [ADP2102-3-EVALZ](#) [ADP2102-4-EVALZ](#) [AS3606-DB](#) [BQ25010EVM](#) [BQ3055EVM](#) [ISLUSBI2CKIT1Z](#) [LP38512TS-1.8EV](#) [EVAL-ADM1186-1MBZ](#) [EVAL-ADM1186-2MBZ](#) [ADP122UJZ-REDYKIT](#) [ADP166Z-REDYKIT](#) [ADP170-1.8-EVALZ](#) [ADP171-EVALZ](#) [ADP1853-EVALZ](#) [ADP1873-0.3-EVALZ](#) [ADP198CP-EVALZ](#) [ADP2102-1.0-EVALZ](#) [ADP2102-1-EVALZ](#) [ADP2107-1.8-EVALZ](#) [ADP5020CP-EVALZ](#) [CC-ACC-DBMX-51](#) [ATPL230A-EK](#) [MIC23250-S4YMT EV](#) [MIC26603YJL EV](#) [MIC33050-SYHL EV](#) [TPS60100EVM-131](#) [TPS65010EVM-230](#) [TPS71933-28EVM-213](#) [TPS72728YFFEVM-407](#) [TPS79318YEQEVM](#) [UCC28810EVM-002](#) [XILINXPWR-083](#) [LMR22007YMINI-EVM](#) [LP38501ATJ-EV](#)