

Click [here](#) for production status of specific part numbers.

MAX22025–MAX22028/ MAX22025F–MAX22028F

Compact, Isolated, Half-Duplex RS-485/RS-422 Transceivers with AutoDirection Control

General Description

The MAX22025–MAX22028/MAX22025F–MAX22028F compact isolated RS-485/RS-422 transceivers provide 3.5kV_{RMS} of digital galvanic isolation between the cable-side (RS-485/RS-422 driver/receiver-side) and the UART-side of the device. Isolation improves communication by breaking ground loops and reduces noise when there are large differences in ground potential between ports. These devices allow for robust communication up to 0.5Mbps or 16Mbps.

The MAX22025–MAX22028/MAX22025F–MAX22028F feature Maxim's proprietary AutoDirection control making these devices ideal for applications such as isolated RS-485 ports, where the driver input is used in conjunction with the driver-enable signal to drive the differential bus.

The MAX22025/MAX22027/MAX22025F/MAX22027F feature reduced slew rate drivers that minimize EMI and reduce reflections caused by improper termination of cable allowing error-free transmission up to 0.5Mbps. The MAX22026/MAX22028/MAX22026F/MAX22028F driver outputs are not slew-rate limited, allowing transmit speeds up to 16Mbps.

The receiver output of the MAX22025/MAX22026/MAX22025F/MAX22026F does not follow (V_A-V_B) when the device is in the driver-enabled state. The receiver output on the MAX22027/MAX22028/MAX22027F/MAX22028F always follows (V_A-V_B).

The driver outputs and receiver inputs are protected from ± 10 kV electrostatic discharge (ESD) to GNDB on the cable side, as specified by the Human Body Model (HBM). The MAX22025–MAX22028/MAX22025F–MAX22028F are available in a compact 8-pin wide body SOIC package and operate over the -40°C to $+85^{\circ}\text{C}$ temperature range.

Applications

- Utility Meters
- Industrial Automation Equipment
- Programmable Logic Controllers
- HVAC

Ordering Information appears at end of data sheet.

Benefits and Features

- High-Level Integration Reduces Overall Solution Size
 - Fully Isolated Half-Duplex RS-485/RS-422 Transceivers
 - Compact 8-Pin Wide Body SOIC Package (5.5mm Creepage)
- Integrated Protection Ensures Robust Communication
 - ± 10 kV ESD (HBM) on Driver Outputs/Receiver Inputs
 - Failsafe Receiver Prevents Fault Transition on Receiver Input Short or Open Events (MAX22025F–MAX22028F)
 - Withstands 3.5kV_{RMS} Isolation Voltage for 60 Seconds (V_{ISO})
 - Withstands 630V_{PEAK} Maximum Repetitive Peak-Isolation Voltage (V_{IORM})
 - Continuously Withstands 445V_{RMS} Maximum Working-Isolation Voltage (V_{IOWM})
- Enables Flexible System Design
 - 0.5Mbps Maximum Data Rate with Slew-Rate Limited Driver (MAX22025/MAX22027/MAX22025F/MAX22027F)
 - 16Mbps Maximum Data Rate (MAX22026/MAX22028/MAX22026F/MAX22028F)
 - AutoDirection Eliminates the Need for DE and \overline{RE} Control Signals

Safety Regulatory Approvals

- UL According to UL1577
- cUL According to CSA Bulletin 5A

Functional Diagram

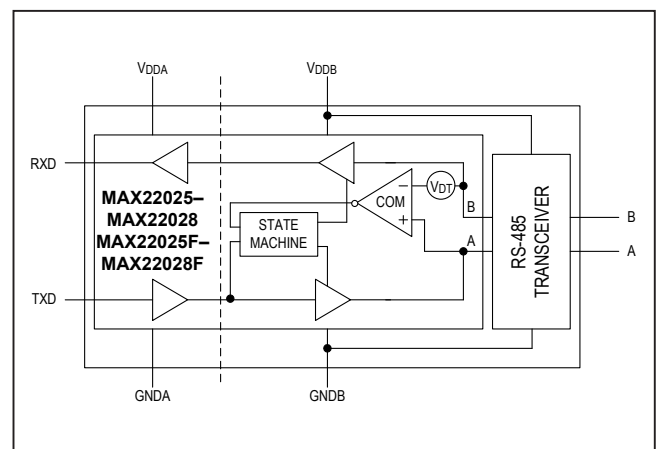

MAX22025–MAX22028/
MAX22025F–MAX22028F

Compact, Isolated, Half-Duplex RS-485/RS-422
Transceivers with AutoDirection Control

Absolute Maximum Ratings

V _{DDA} , TXD to GNDA	-0.3V to +6V
V _{DDB} to GNDB	-0.3V to +6V
RXD to GNDA	-0.3V to (V _{DDA} + 0.3V)
A, B to GNDB	-8V to +13V
Short Circuit Duration (RXD to GNDA)	Continuous
Short Circuit Duration (A, B to GNDB)	Continuous

Continuous Power Dissipation (T _A = +70°C) 8-pin Wide SOIC (derate 23mW/°C above +70°C) ...	1847mW
Operating Temperature Range	-40°C to +85°C
Junction Temperature	+150°C
Storage Temperature Range	-65°C to +150°C
Lead Temperature (soldering, 10s)	+300°C
Soldering Temperature (reflow)	+260°C

Stresses beyond those listed under "Absolute Maximum Ratings" may cause permanent damage to the device. These are stress ratings only, and functional operation of the device at these or any other conditions beyond those indicated in the operational sections of the specifications is not implied. Exposure to absolute maximum rating conditions for extended periods may affect device reliability.

Package Information

PACKAGE TYPE: 8 Wide SOIC	
Package Code	W8MS+1
Outline Number	21-0262
Land Pattern Number	90-0258
THERMAL RESISTANCE, FOUR-LAYER BOARD	
Junction to Ambient (θ _{JA})	43.3°C/W
Junction to Case (θ _{JC})	36.5°C/W

Package thermal resistances were obtained using the method described in JEDEC specification JESD51-7, using a four-layer board. For detailed information on package thermal considerations, refer to www.maximintegrated.com/thermal-tutorial.

For the latest package outline information and land patterns (footprints), go to www.maximintegrated.com/packages. Note that a "+", "#", or "-" in the package code indicates RoHS status only. Package drawings may show a different suffix character, but the drawing pertains to the package regardless of RoHS status.

DC Electrical Characteristics

(V_{DDA} – V_{GNDA} = 1.71V to 5.5V, V_{DDB} – V_{GNDB} = 4.75V to 5.25V, T_A = T_{MIN} to T_{MAX}, unless otherwise noted. Typical values are at V_{DDA} – V_{GNDA} = 3.3V, V_{DDB} – V_{GNDB} = 5V, V_{GNDA} = V_{GNDB}, and T_A = +25°C.) (Notes 1, 2)

PARAMETER	SYMBOL	CONDITIONS	MIN	TYP	MAX	UNITS
POWER						
Supply Voltage	V _{DDA}		1.71		5.5	V
	V _{DDB}		4.75		5.25	
Supply Current	I _{DDA}	V _{DDA} = 3.3V, RXD is unconnected, TXD = low, no bus load		0.39	0.7	mA
	I _{DDB}	V _{DDB} = 5V, RXD is unconnected, TXD = low, no bus load		4.0	5.5	
V _{DDA} Undervoltage Lockout Threshold	V _{UVLOA}	V _{DDA} rising	1.5	1.6	1.66	V
V _{DDA} Undervoltage Lockout Threshold Hysteresis	V _{UVHYSTA}			45		mV
LOGIC INTERFACE (TXD, RXD)						
Input High Voltage	V _{IH}	TXD to GNDA	2.25V ≤ V _{DDA} ≤ 5.5V	0.7 x V _{DDA}		V
			1.71V ≤ V _{DDA} < 2.25V	0.75 x V _{DDA}		

DC Electrical Characteristics (continued)

($V_{DDA} - V_{GNDA} = 1.71V$ to $5.5V$, $V_{DDB} - V_{GNDB} = 4.75V$ to $5.25V$, $T_A = T_{MIN}$ to T_{MAX} , unless otherwise noted. Typical values are at $V_{DDA} - V_{GNDA} = 3.3V$, $V_{DDB} - V_{GNDB} = 5V$, $V_{GNDA} = V_{GNDB}$, and $T_A = +25^{\circ}C$.) (Notes 1, 2)

PARAMETER	SYMBOL	CONDITIONS		MIN	TYP	MAX	UNITS
Input Low Voltage	V_{IL}	TXD to GNDA	$2.25V \leq V_{DDA} \leq 5.5V$			0.8	V
			$1.71V \leq V_{DDA} < 2.25V$			0.7	
Input Hysteresis	V_{HYS}	TXD to GNDA			410		mV
Input Capacitance	C_{IN}	TXD, $f = 1MHz$			2		pF
Input Pullup Current	I_{PU}	TXD		-10	-5	-1.5	μA
Output Voltage High	V_{OH}	RXD to GNDA, $I_{OUT} = -4mA$		V_{DDA}			V
Output Voltage Low	V_{OL}	RXD to GNDA, $I_{OUT} = 4mA$				0.4	V
DRIVER							
Differential Driver Output	$ V_{OD} $	$R_L = 100\Omega$, TXD = low, Figure 1a		2.0		V_{DDB}	V
		$R_L = 54\Omega$, TXD = low, Figure 1a		1.5		V_{DDB}	
		$-7V \leq V_{CM} \leq +12V$, TXD = low, Figure 1b		1.5		5	
Driver Common-Mode Output Voltage	V_{OC}	$R_L = 100\Omega$ or 54Ω , TXD = low, Figure 1a			$V_{DDB}/2$	3	V
Driver Disable Threshold	V_{DT}	TXD = low to high (Note 3)		0.6		1	V
Driver Short-Circuit Output Current	I_{OSD}	$GNDB \leq V_{OUT} \leq +12V$, output low		+50		+250	mA
		$-7V \leq V_{OUT} \leq V_{DDB}$, output high		-250		-50	
Driver Short-Circuit Foldback Output Current	I_{SH}	$(V_{DDB}-1V) \leq V_{OUT} \leq +12V$, output low		+20			mA
		$-7V \leq V_{OUT} \leq V_{DDB}$, output high				-20	
RECEIVER							
Input Current (A and B)	I_A, I_B	$V_{DDB} = GNDB$ or $5V$, receive state	$V_{IN} = +12V$			+250	μA
			$V_{IN} = -7V$		-200		
Receiver Differential Threshold Voltage	V_{TH}	$-7V \leq V_{CM} \leq +12V$	MAX22025– MAX22028	-200		+200	mV
			MAX22025F– MAX22028F	-200		-50	
Receiver Input Hysteresis	ΔV_{TH}	$V_{CM} = 0V$			25		mV
Receiver Input Resistance	R_{IN}	$-7V \leq V_{CM} \leq +12V$, Receive state			60		k Ω
THERMAL SHUTDOWN							
Thermal Shutdown Threshold	T_{SHDN}	Temperature rising			+135		$^{\circ}C$
Thermal Shutdown Hysteresis	T_{SHDN_HYS}				20		$^{\circ}C$
PROTECTION							
ESD Protection (A and B Pins to GNDB)		Human Body Model			± 10		kV
ESD Protection (A and B Pins to GNDA) with 47pF Capacitor Connected between GNDA and GNDB		Human Body Model			± 7		kV
ESD Protection (All Other Pins)		Human Body Model			± 4		kV

Switching Electrical Characteristics (MAX22025/MAX22027/MAX22025F/MAX22027F)

($V_{DDA} - V_{GNDA} = 1.71V$ to $5.5V$, $V_{DDB} - V_{GNDB} = 4.75V$ to $5.25V$, $T_A = T_{MIN}$ to T_{MAX} , unless otherwise noted. Typical values are at $V_{DDA} - V_{GNDA} = 3.3V$, $V_{DDB} - V_{GNDB} = 5V$, $V_{GNDA} = V_{GNDB}$, and $T_A = +25^\circ C$.) (Notes 1, 2)

PARAMETER	SYMBOL	CONDITIONS	MIN	TYP	MAX	UNITS
Common Mode Transient Immunity	CMTI	(Note 5)		50		kV/ μ s
DRIVER						
Driver Propagation Delay	t_{DPLH} , t_{DPHL}	$R_L = 110\Omega$, $C_L = 50pF$, Figure 2 and Figure 3 (Note 4)	200		1000	ns
Driver Differential Output Rise or Fall Time	t_{LH} , t_{HL}	$R_L = 110\Omega$, $C_L = 50pF$, Figure 2 and Figure 3 (Note 4)	200		900	ns
Maximum Data Rate	DR_{MAX}		0.5			Mbps
Driver Enable from Power Up	t_{PORD}			100	150	μ s
RECEIVER						
Receiver Propagation Delay	t_{RPLH} , t_{RPHL}	$C_L = 15pF$, Figure 4 and Figure 5 (Note 4)			80	ns
Receiver Output Skew $ t_{RPLH} - t_{RPHL} $	t_{RSKEW}	$C_L = 15pF$, Figure 5 (Note 4)			13	ns
Maximum Data Rate	DR_{MAX}		16			Mbps
Receiver Enable from Power Up	t_{PORR}			100	150	μ s

Switching Electrical Characteristics (MAX22026/MAX22028/MAX22026F/MAX22028F)

($V_{DDA} - V_{GNDA} = 1.71V$ to $5.5V$, $V_{DDB} - V_{GNDB} = 4.75V$ to $5.25V$, $T_A = T_{MIN}$ to T_{MAX} , unless otherwise noted. Typical values are at $V_{DDA} - V_{GNDA} = 3.3V$, $V_{DDB} - V_{GNDB} = 5V$, $V_{GNDA} = V_{GNDB}$, and $T_A = +25^\circ C$.) (Notes 1, 2)

PARAMETER	SYMBOL	CONDITIONS	MIN	TYP	MAX	UNITS
Common Mode Transient Immunity	CMTI	(Note 5)		50		kV/ μ s
DRIVER						
Driver Propagation Delay	t_{DPLH} , t_{DPHL}	$R_L = 110\Omega$, $C_L = 50pF$, Figure 2 and Figure 3 (Note 4)			50	ns
Driver Differential Output Rise or Fall Time	t_{LH} , t_{HL}	$R_L = 110\Omega$, $C_L = 50pF$, Figure 2 and Figure 3 (Note 4)			15	ns
Maximum Data Rate	DR_{MAX}		16			Mbps
Driver Enable from Power Up	t_{PORD}			100	150	μ s
RECEIVER						
Receiver Propagation Delay	t_{RPLH} , t_{RPHL}	$C_L = 15pF$, Figure 4 and Figure 5 (Note 4)			80	ns
Receiver Output Skew $ t_{RPLH} - t_{RPHL} $	t_{RSKEW}	$C_L = 15pF$, Figure 5 (Note 4)			13	ns
Maximum Data Rate	DR_{MAX}		16			Mbps
Receiver Enable from Power Up	t_{PORR}			100	150	μ s

Note 1: All devices are 100% production tested at $T_A = +85^\circ C$. Specifications over temperature are guaranteed by design.

Note 2: All currents into the device are positive. All currents out of the device are negative. All voltages are referenced to their respective ground (GNDA or GNDB), unless otherwise noted.

Note 3: This is the differential voltage from A to B that the driving device must see on the bus to disable its driver.

Note 4: Not production tested. Guaranteed by design.

Note 5: CMTI is the maximum sustainable common-mode voltage slew rate while maintaining the correct output states. CMTI applies to both rising and falling common-mode voltage edges. Tested with the transient generator connected between GNDA and GNDB. $V_{CM} = 1kV$

Insulation Characteristics

PARAMETER	SYMBOL	CONDITIONS	VALUE	UNITS
Maximum Repetitive Peak Withstand Voltage	V_{IORM}	(Note 6)	630	V_P
Maximum Working Isolation Voltage	V_{IOWM}	GNDA to GNDB continuous (Note 6)	445	V_{RMS}
Maximum Transient Isolation Voltage	V_{IOTM}		5000	V_P
Maximum Withstand Isolation Voltage	V_{ISO}	GNDA to GNDB for 60s (Note 7)	3500	V_{RMS}
Maximum Surge Isolation Voltage	V_{IOSM}	Basic Insulation, 1.2/50 μ s pulse per IEC61000-4-5	10	kV
Insulation Resistance	R_S	$T_A = +150^\circ\text{C}$, $V_{IO} = 500\text{V}$	$>10^9$	Ω
Barrier Capacitance Side A to Side B	CIO	GNDA to GNDB	2	pF
Minimum Creepage Distance	CPG		5.5	mm
Minimum Clearance Distance	CLR		5.5	mm
Internal Clearance		Distance through insulation	0.015	mm
Comparitive Tracking Resistance Index	CTI		>400	
Climatic Category			40/125/21	
Pollution Degree			2	

Note 6: V_{IORM} , V_{IOWM} , and V_{ISO} are defined by the IEC 60747-5-5 standard.

Note 7: Product is qualified at V_{ISO} for 60 seconds. Not production tested.

Safety Regulatory Approvals

UL
The MAX22025–MAX22028 and MAX22025F–MAX22028F are certified under UL1577. For more details, refer to File E351759.
Rated up to 3500 V_{RMS} for single protection.
cUL (Equivalent to CSA notice 5A)
The MAX22025–MAX22028 and MAX22025F–MAX22028F are certified up to 3500 V_{RMS} for single protection. For more details, refer to File E351759.

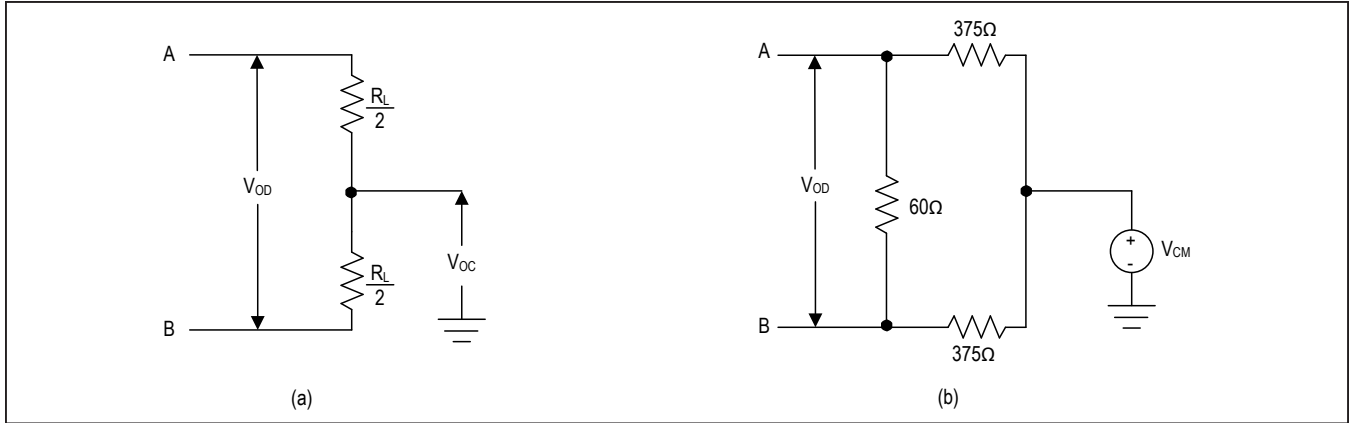

Figure 1. Driver DC Test Load

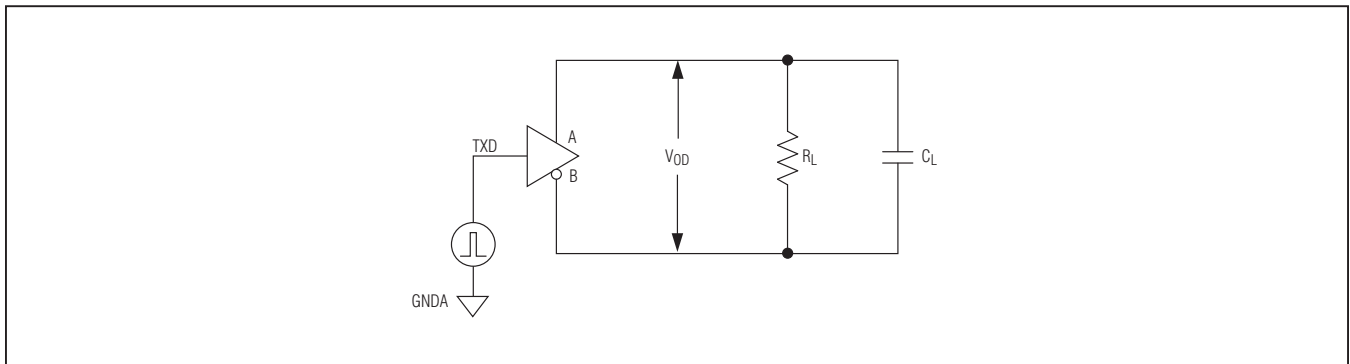

Figure 2. Driver Timing Test Circuit

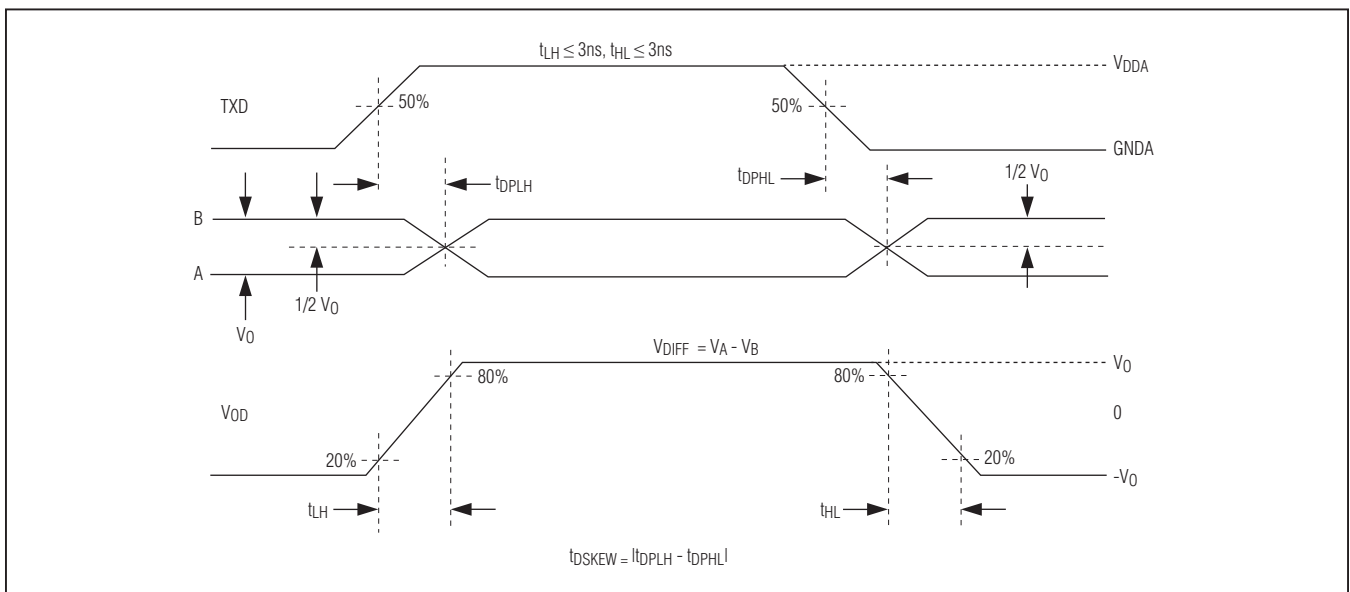

Figure 3. Driver Propagation Delays

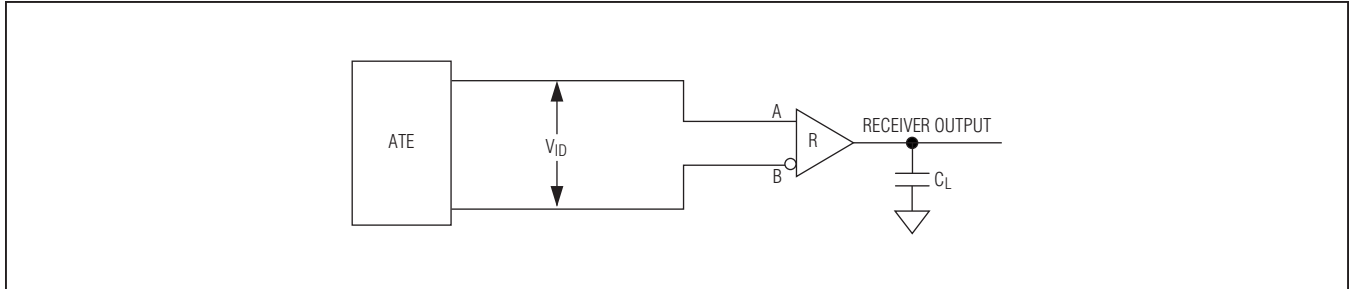

Figure 4. Receiver Propagation Delay Test Circuit

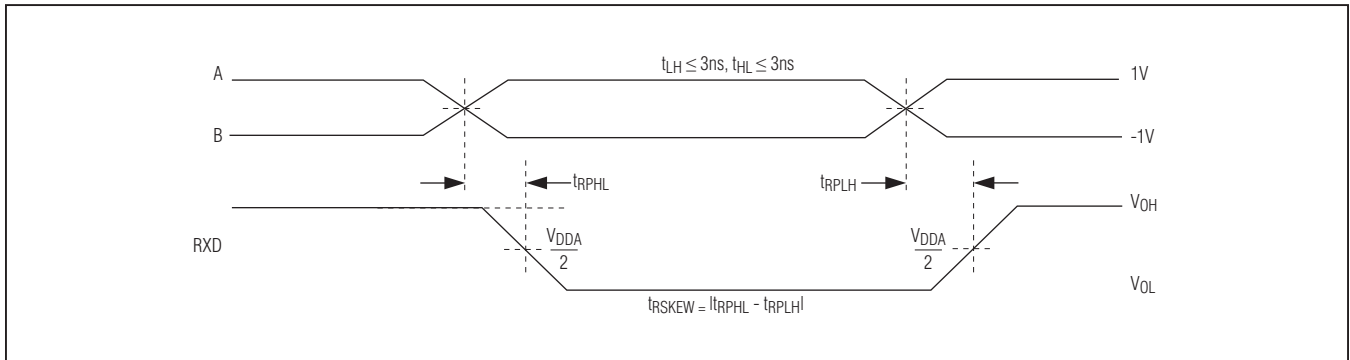
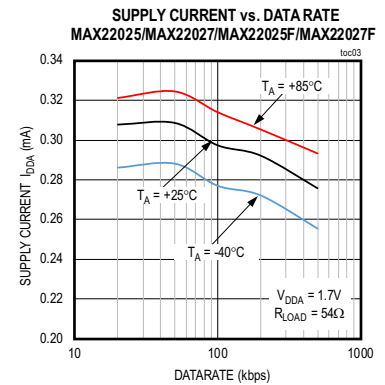
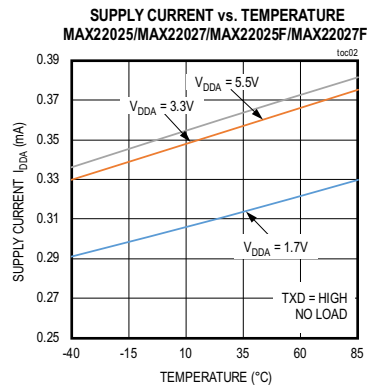
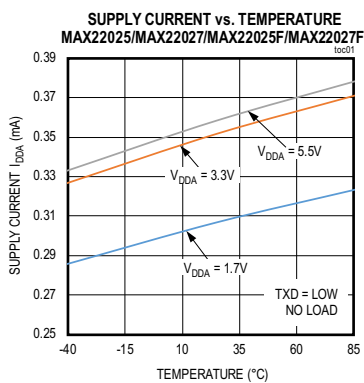

Figure 5. Receiver Propagation Delays

Typical Operating Characteristics

($V_{DDA} - V_{GNDA} = 3.3V$, $V_{DDB} - V_{GNDB} = 5V$, $V_{GNDA} = V_{GNDB}$, and $T_A = +25^\circ C$, unless otherwise noted.)



Typical Operating Characteristics (continued)

($V_{DDA} - V_{GNDA} = 3.3V$, $V_{DDB} - V_{GNDB} = 5V$, $V_{GNDA} = V_{GNDB}$, and $T_A = +25^\circ C$, unless otherwise noted.)

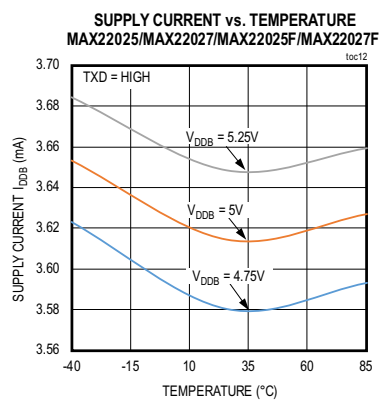
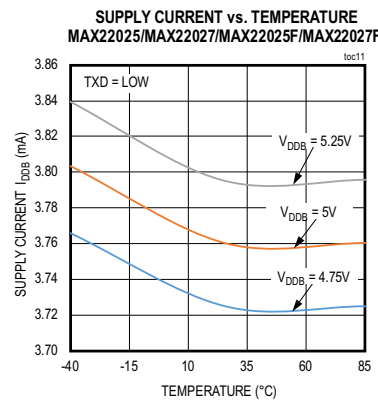
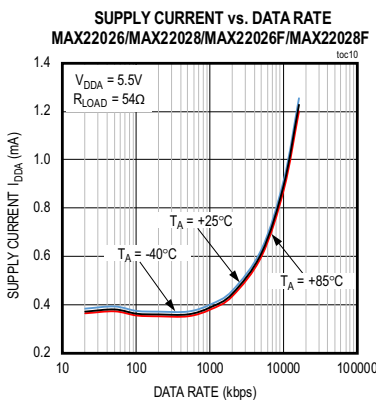
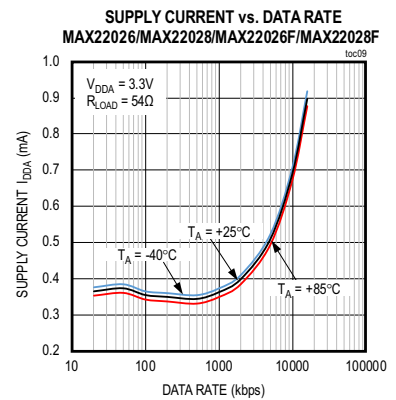
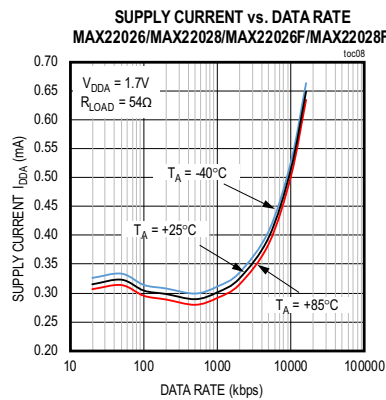
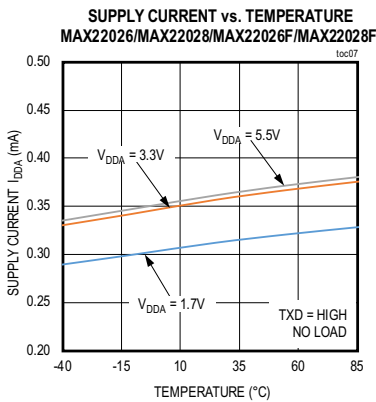
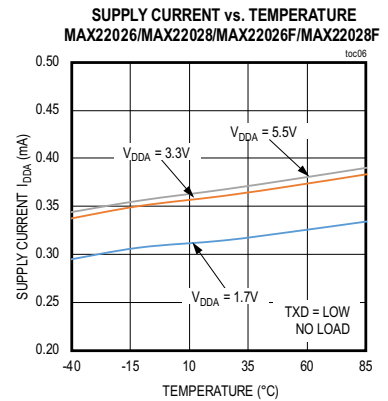
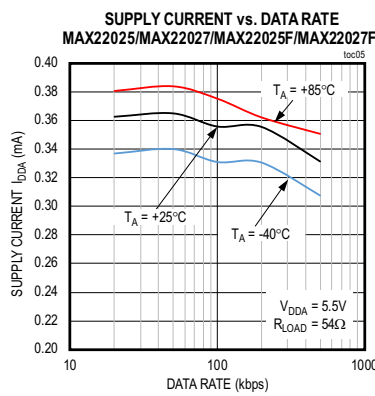
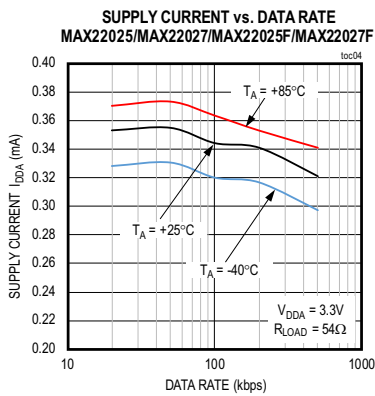

Typical Operating Characteristics (continued)

($V_{DDA} - V_{GNDA} = 3.3V$, $V_{DDB} - V_{GNDB} = 5V$, $V_{GNDA} = V_{GNDB}$, and $T_A = +25^\circ C$, unless otherwise noted.)

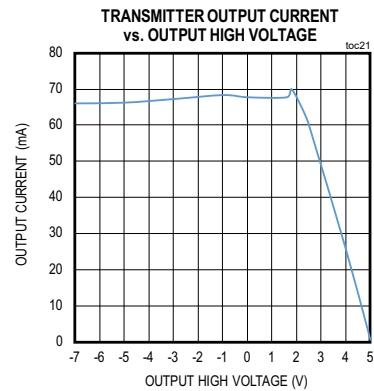
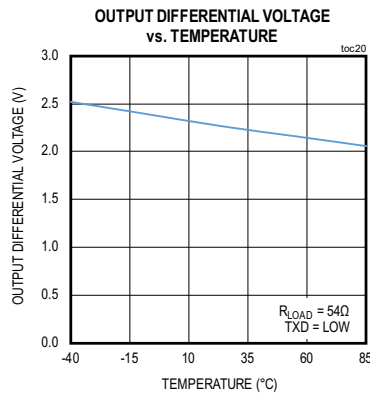
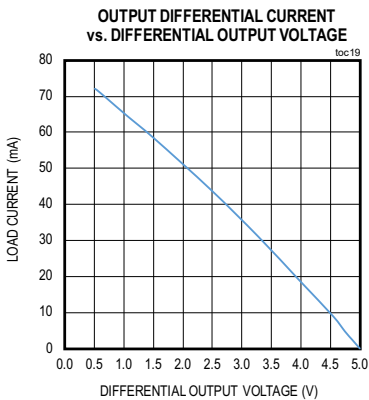
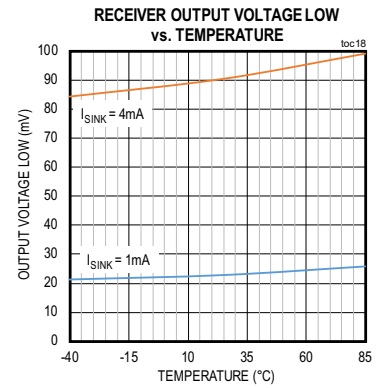
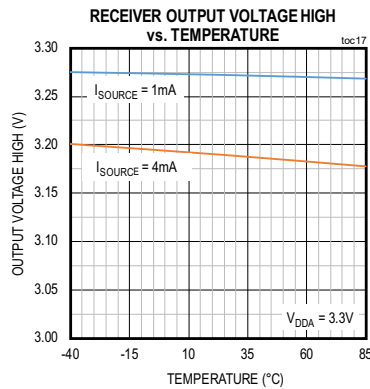
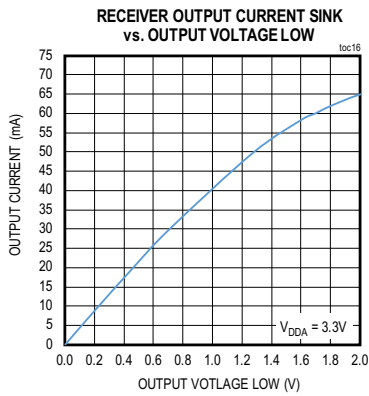
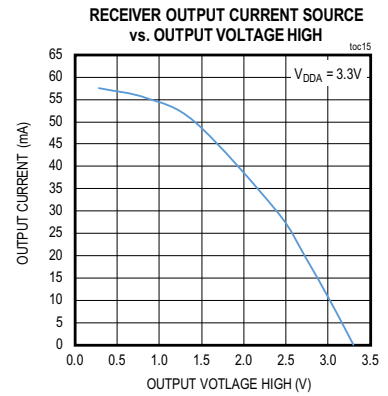
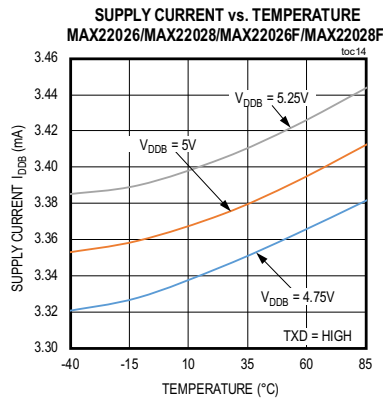
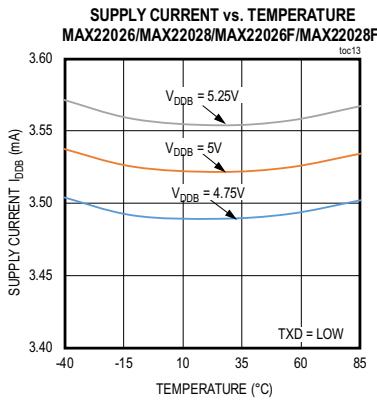

Typical Operating Characteristics (continued)

($V_{DDA} - V_{GNDA} = 3.3V$, $V_{DDB} - V_{GNDB} = 5V$, $V_{GNDA} = V_{GNDB}$, and $T_A = +25^\circ C$, unless otherwise noted.)

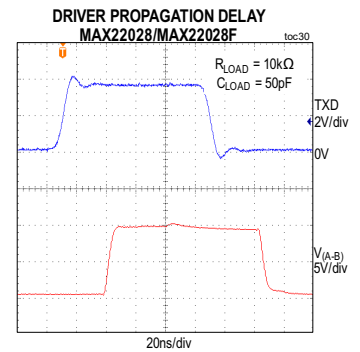
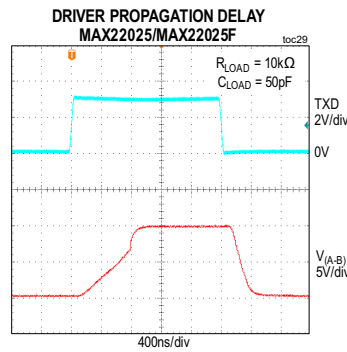
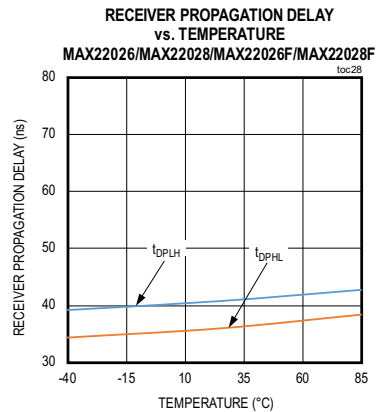
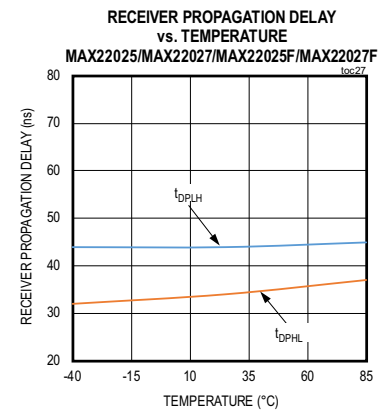
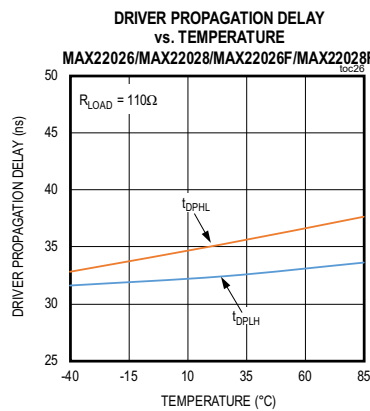
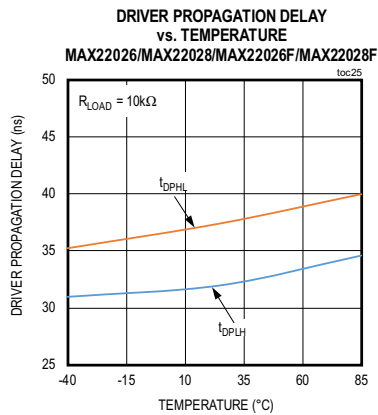
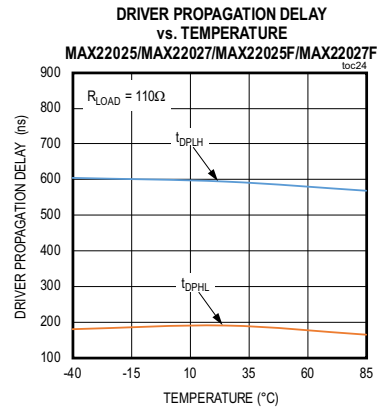
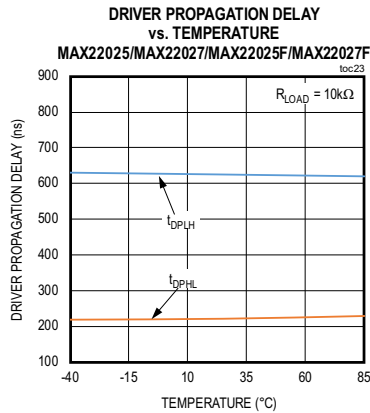
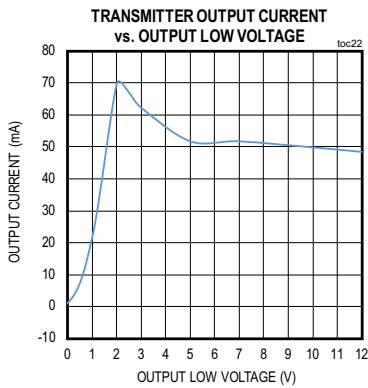

Typical Operating Characteristics (continued)

($V_{DDA} - V_{GNDA} = 3.3V$, $V_{DDB} - V_{GNDB} = 5V$, $V_{GNDA} = V_{GNDB}$, and $T_A = +25^\circ C$, unless otherwise noted.)

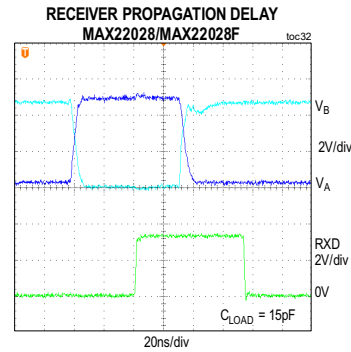
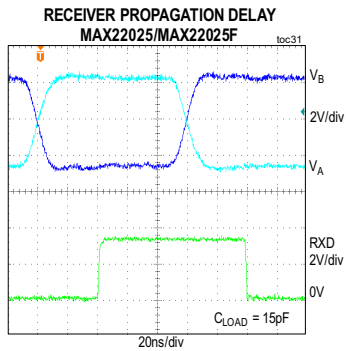

Pin Configuration

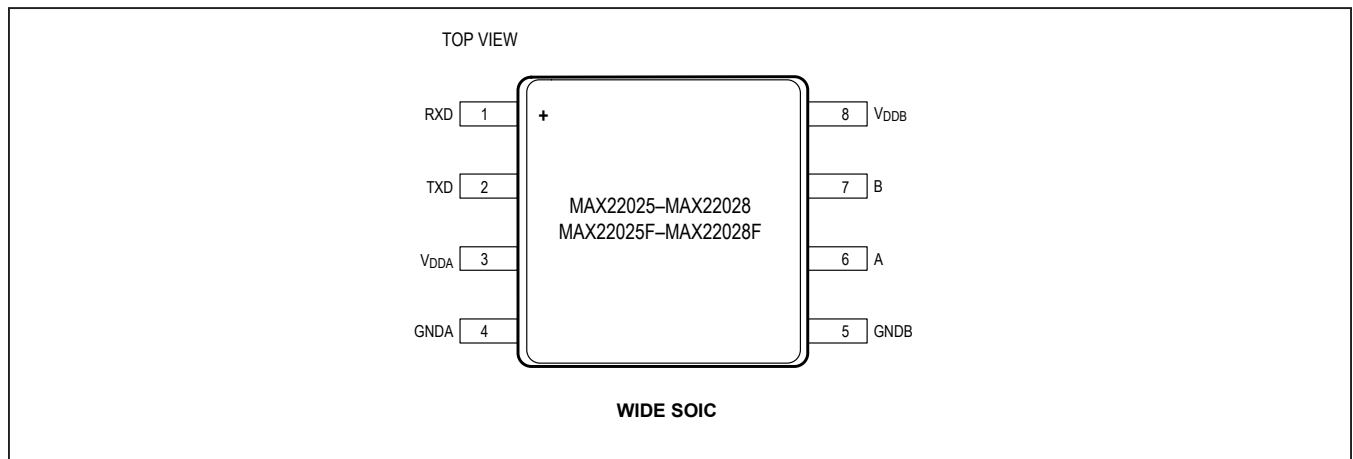

Pin Description

PIN	NAME	REFERENCE	FUNCTION
1	RXD	GNDA	Receiver Data Output. See the Function Tables for more information.
2	TXD	GNDA	Driver Input. TXD is the input to the internal state machine that automatically enables and disables the driver. See the Function Tables and AutoDirection Circuitry sections for more information. TXD has an internal 5 μ A pullup to V_{DDA} .
3	V_{DDA}	GNDA	UART/Logic-Side Power Input. Bypass V_{DDA} to GNDA with both 0.1 μ F and 1 μ F capacitors as close to the device as possible.
4	GNDA	-	UART/Logic-Side Ground. GNDA is the ground reference for digital signals.
5	GNDB	-	Cable Side Ground. GNDB is the ground reference for the RS-485/RS-422 bus signals.
6	A	GNDB	Noninverting Driver Output/Receiver Input
7	B	GNDB	Inverting Driver Output/Receiver Input
8	V_{DDB}	GNDB	Cable Side Power Input. Bypass V_{DDB} to GNDB with both 0.1 μ F and 1 μ F capacitors as close to the device as possible.

Function Tables

TRANSMIT FUNCTIONALITY					
TXD	(V _A - V _B)	PREVIOUS STATE	CURRENT STATE	A	B
0	X	X	Driver Enabled	0	1
1	(V _A - V _B) ≥ V _{DT}	X	Receiver Enabled	High-Z	High-Z
1	(V _A - V _B) < V _{DT}	Driver Enabled	Driver Enabled	1	0
		Receiver Enabled	Receiver Enabled	High-Z	High-Z

X = Don't care

RXD FUNCTIONALITY (STANDARD RECEIVER)			
CURRENT STATE	(V _A - V _B)	RXD	
		MAX22025/MAX22026	MAX22027/MAX22028
Receiver Enabled	(V _A - V _B) ≥ +200mV	1	1
	(V _A - V _B) ≤ -200mV	0	0
Driver Enabled	(V _A - V _B) ≥ +200mV	1	1
	(V _A - V _B) ≤ -200mV	1	0

RXD FUNCTIONALITY (FAILSAFE RECEIVER)			
CURRENT STATE	(V _A - V _B)	RXD	
		MAX22025F/MAX22026F	MAX22027F/MAX22028F
Receiver Enabled	(V _A - V _B) ≥ -50mV	1	1
	(V _A - V _B) ≤ -200mV	0	0
Driver Enabled	(V _A - V _B) ≥ -50mV	1	1
	(V _A - V _B) ≤ -200mV	1	0

Detailed Description

The MAX22025–MAX22028/MAX22025F–MAX22028F isolated RS-485/RS-422 transceivers provide 3500V_{RMS} (60s) of galvanic isolation between the RS-485/RS-422 cable side of the transceiver and the UART side. These devices allow up to 0.5Mbps (MAX22025/MAX22027/MAX22025F/MAX22027F) or 16Mbps (MAX22026/MAX22028/MAX22026F/MAX22028F) communication across an isolation barrier when a large potential exists between grounds on each side of the barrier.

Isolation

Data isolation is achieved using high-voltage capacitors that allow data transmission between the UART side and the RS-485/RS-422 cable side of the transceiver.

AutoDirection Circuitry

Internal circuitry in the MAX22025–MAX22028/MAX22025F–MAX22028F, in conjunction with an external pullup resistor on A and pulldown resistor on B (see Typical Application Circuit), acts to automatically disable or enable the driver and the receiver to keep the bus in

the correct state. This AutoDirection circuitry consists of a state machine and an additional receive comparator that determine whether this device is trying to drive the bus or another node on the network is driving the bus.

The internal state machine has two inputs:

- TXD
- The current state of (V_A-V_B), which is determined by a dedicated differential comparator.

The state machine also has two outputs:

- DRIVER_ENABLE—Internal signal that enables and disables the driver
- RECEIVER_ENABLE—Internal signal that is the inverse of the DRIVER_ENABLE signal.

When TXD is low, the device always drives the bus low. When TXD switches high, the device drives the bus for a short time, then disables the driver and allows the external pullup/pulldown resistors to hold the bus in the high state. During each low-to-high transition of TXD, the driver stays enabled until (V_A-V_B) ≥ V_{DT}. The driver is then disabled and the pullup/pulldown resistors hold the A and B lines in the correct state.

Pullup and Pulldown Resistors

The pullup and pulldown resistors on the A and B lines are required for proper operation of the device although their exact value is not critical. They function to hold the bus in the high state following a low-to-high transition. Sizing of these resistors is determined in the same way as when using any other RS-485 driver and depends on how the line is terminated and how many nodes are on the bus. The most important factor when sizing these resistors is to guarantee that the idle voltage on the bus ($V_A - V_B$) is greater than the receiver input threshold (+200mV for the MAX22025–MAX22028, -50mV for the MAX22025F–MAX22028F) in order to remain compatible with standard RS-485 receiver thresholds.

Receive State

When not transmitting data, the MAX22025–MAX22028/MAX22025F–MAX22028F require the TXD input be high to remain in the receive state. A conventional RS-485 transceiver has DE and \overline{RE} inputs that are used to enable and disable the driver and receiver. However, the MAX22025–MAX22028/MAX22025F–MAX22028F do not have a DE input, and instead use an internal state machine to enable and disable the drivers.

Failsafe Receiver (MAX22025F–MAX22028F only)

The MAX22025F–MAX22028F guarantee a logic high on the receiver output when the receiver inputs are shorted or open, or when they are connected to a terminated transmission line with all drivers disabled. If the differential receiver input voltage ($V_A - V_B$) is greater than or equal to -50mV, RXD is a logic-high.

Receiver Output (RXD)

The receiver output (RXD) of the MAX22025–MAX22028/MAX22025F–MAX22028F does not follow TXD when the device is in the driver-enabled state. This allows for line interference detection by verifying that RXD remains high throughout data transmission.

On the MAX22027/MAX22028/MAX22027F/MAX22028F, the receiver output (RXD) always follows ($V_A - V_B$).

ESD Protection

ESD protection structures are incorporated on all pins to protect against electrostatic discharge encountered during handling and assembly. The driver outputs and receiver inputs of the devices have extra protection against static electricity to both the UART side and cable side ground references. The ESD structures withstand high-ESD events during normal operation and when powered down. After an ESD event, the devices keep working without latch-up or damage.

Bypass V_{DDA} to $GNDA$ and bypass V_{ddb} to $GNDB$ with 0.1 μ F and 1 μ F capacitors to ensure maximum ESD protection.

ESD Test Conditions

ESD performance depends on a variety of conditions. Contact Maxim for a reliability report that documents test setup, test methodology, and test results.

Human Body Model (HBM)

Figure 6 shows the HBM test model, while Figure 7 shows the current waveform it generates when discharged in a low-impedance state. This model consists of a 100pF capacitor charged to the ESD voltage of interest, which is then discharged into the test device through a 1.5k Ω resistor.

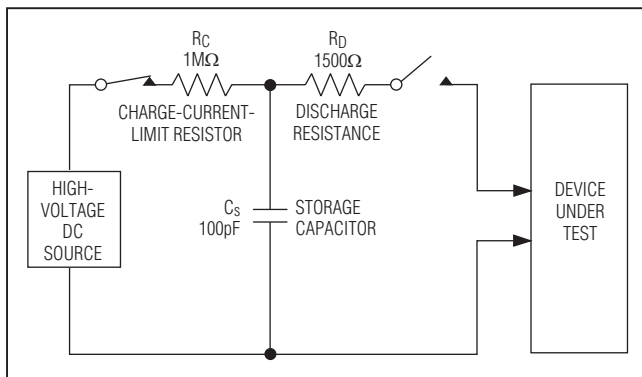

Figure 6. Human Body ESD Test Model

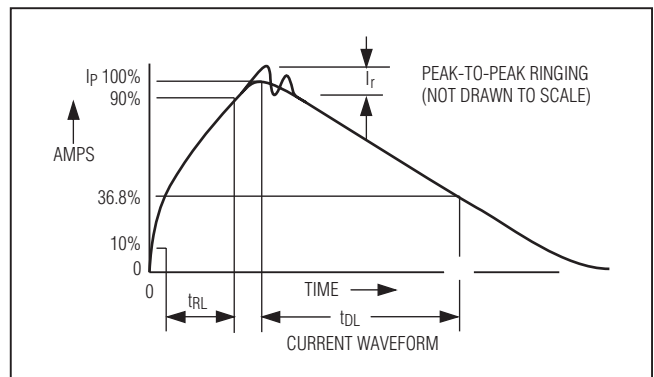
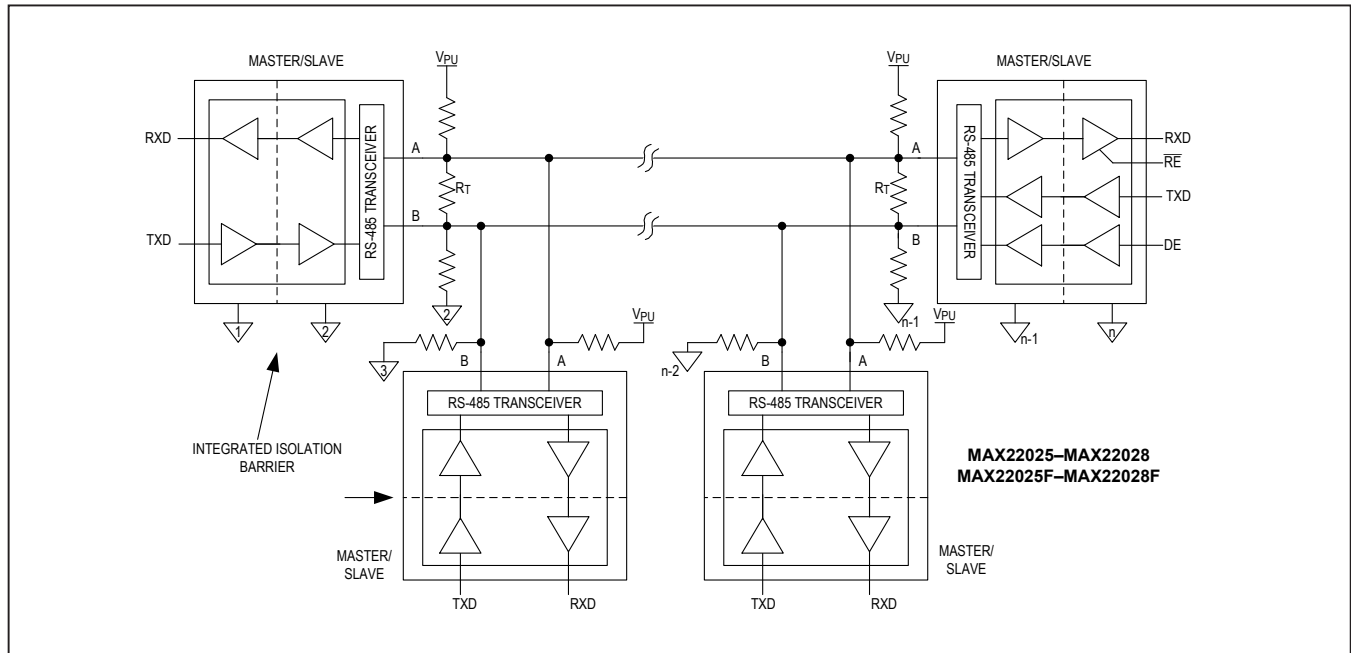
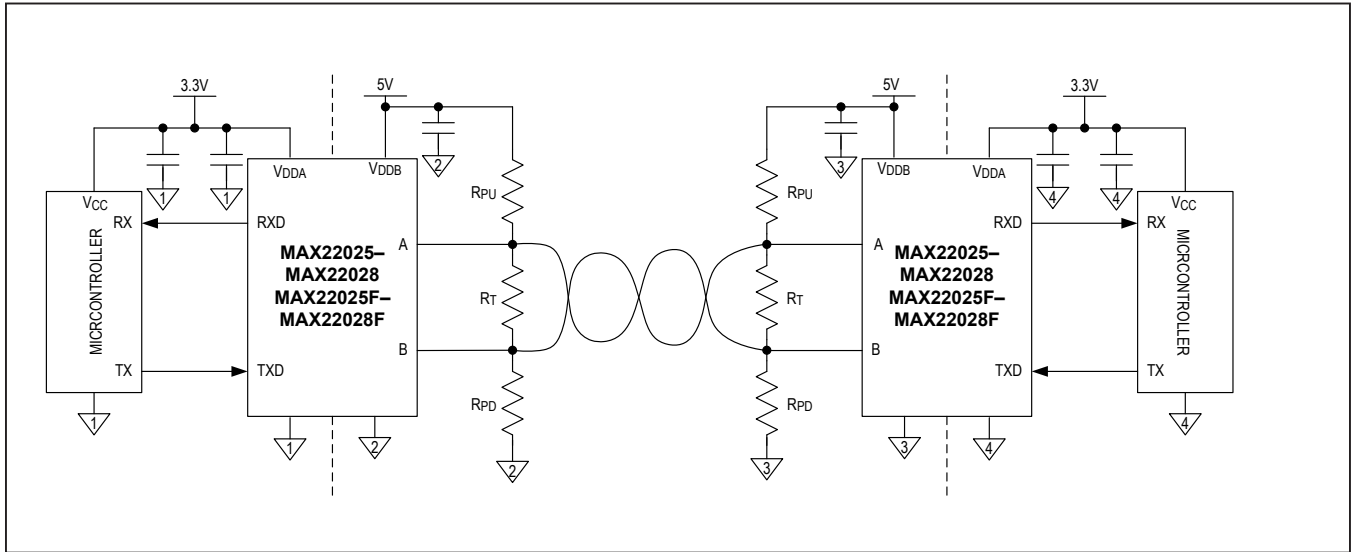

Figure 7. Human Body Current Waveform

Typical Application Circuits



MAX22025–MAX22028/
MAX22025F–MAX22028F

Compact, Isolated, Half-Duplex RS-485/RS-422
Transceivers with AutoDirection Control

Ordering Information

PART	TEMP RANGE	RXD IN DRIVER-ENABLED STATE	DRIVER SPEED (Mbps)	PIN-PACKAGE
MAX22025AWA+	-40°C to +85°C	HIGH	0.5	8 Wide SOIC
MAX22025AWA+T	-40°C to +85°C	HIGH	0.5	8 Wide SOIC
MAX22026AWA+*	-40°C to +85°C	HIGH	16	8 Wide SOIC
MAX22026AWA+T*	-40°C to +85°C	HIGH	16	8 Wide SOIC
MAX22027AWA+*	-40°C to +85°C	FOLLOWS (V _A -V _B)	0.5	8 Wide SOIC
MAX22027AWA+T*	-40°C to +85°C	FOLLOWS (V _A -V _B)	0.5	8 Wide SOIC
MAX22028AWA+	-40°C to +85°C	FOLLOWS (V _A -V _B)	16	8 Wide SOIC
MAX22028AWA+T	-40°C to +85°C	FOLLOWS (V _A -V _B)	16	8 Wide SOIC
MAX22025FAWA+	-40°C to +85°C	HIGH	0.5	8 Wide SOIC
MAX22025FAWA+T	-40°C to +85°C	HIGH	0.5	8 Wide SOIC
MAX22026FAWA+*	-40°C to +85°C	HIGH	16	8 Wide SOIC
MAX22026FAWA+T*	-40°C to +85°C	HIGH	16	8 Wide SOIC
MAX22027FAWA+*	-40°C to +85°C	FOLLOWS (V _A -V _B)	0.5	8 Wide SOIC
MAX22027FAWA+T*	-40°C to +85°C	FOLLOWS (V _A -V _B)	0.5	8 Wide SOIC
MAX22028FAWA+*	-40°C to +85°C	FOLLOWS (V _A -V _B)	16	8 Wide SOIC
MAX22028FAWA+T*	-40°C to +85°C	FOLLOWS (V _A -V _B)	16	8 Wide SOIC

+Denotes a lead(Pb)-free/RoHS-compliant package.

T = Tape and reel.

*Future product—contact factory for availability.

Chip Information

PROCESS: BiCMOS

Revision History

REVISION NUMBER	REVISION DATE	DESCRIPTION	PAGES CHANGED
0	8/19	Initial release	—
1	9/19	Updated the <i>Electrical Characteristics</i> section and added future product designation to MAX22025AWA+ and MAX22025AWA+T in the <i>Ordering Information</i> section	3, 15
2	11/19	Removed future product designation from MAX22025AWA+ and MAX22025AWA+T in the <i>Ordering Information</i> section	15
3	2/20	Updated the title, <i>General Description, Benefits and Features, Functional Diagram, DC Electrical Characteristics, Switching Electrical Characteristics, Pin Configuration, Functional Tables, Detailed Description, AutoDirection Circuitry, Pullup and Pulldown Resistors, Receive State, Receiver Output (RXD), and Typical Application Circuits</i> sections; updated TOC01–TOC14, TOC23–TOC32; added the <i>Safety Regulatory Approvals</i> table and <i>Failsafe Receiver (MAX22025F–MAX22028F)</i> section; added MAX22025FAWA+, MAX22025FAWA+T, MAX22026FAWA+, MAX22026FAWA+T, MAX22027FAWA+, MAX22027FAWA+T, MAX22028FAWA+, and MAX22028FAWA+T as future parts	1–16
3.1		Corrected typo	1
4	4/20	Removed future product designation from MAX22025FAWA+ and MAX22025FAWA+T in the <i>Ordering Information</i> table	15

For pricing, delivery, and ordering information, please visit Maxim Integrated's online storefront at <https://www.maximintegrated.com/en/storefront/storefront.html>.

Maxim Integrated cannot assume responsibility for use of any circuitry other than circuitry entirely embodied in a Maxim Integrated product. No circuit patent licenses are implied. Maxim Integrated reserves the right to change the circuitry and specifications without notice at any time. The parametric values (min and max limits) shown in the *Electrical Characteristics* table are guaranteed. Other parametric values quoted in this data sheet are provided for guidance.

X-ON Electronics

Largest Supplier of Electrical and Electronic Components

Click to view similar products for [RS-422/RS-485 Interface IC category](#):

Click to view products by [Maxim manufacturer](#):

Other Similar products are found below :

[NSI83085](#) [WS3088EESA-GEC](#) [ADM2687EBRIZ-RL7](#) [MAX489CPD+](#) [MAX485ESA+T](#) [MAX491EPD+](#) [MAX488EESA+](#) [MAX3080CPD+](#)
[MXL1535EEWI+](#) [SN65LBC173DR](#) [DS16F95J/883](#) [MAX490ESA+T](#) [LTM2881IY-3#PBF](#) [LT1791CN#PBF](#) [LTM2881CY-3#PBF](#)
[LTC2852CDD#PBF](#) [LTC2857IMS8-2#PBF](#) [LT1791ACN#PBF](#) [LTC487CS#PBF](#) [MAX1487CUA+T](#) [XR3074XID-F](#) [XR3082XID-F](#)
[SP1481EEN-L](#) [SN75ALS173NSR](#) [ADM3491ARZ-REEL](#) [ADM485JN](#) [ADM1485ANZ](#) [ADM1485JNZ](#) [ADM1490EBRMZ](#) [ADM489ABRZ](#)
[ADM1491EBRZ-REEL7](#) [ADM3070EYRZ](#) [ADM3073EARZ](#) [ADM4850ACPZ-REEL7](#) [ADM4850ARMZ-REEL7](#) [ADM485ANZ](#)
[ADM485ARMZ](#) [ADM485JNZ](#) [ADM488ANZ](#) [ADM489ANZ](#) [ADM489ARUZ](#) [ADM3488ARZ](#) [ADM3488EARZ](#) [ADM3490ARZ](#)
[ADM3493ARZ](#) [ADM4856ARZ-REEL7](#) [ADM487EARZ-REEL7](#) [ADM488ABRZ](#) [ADM1486ARZ](#) [ADM3075EWYRZ](#)