

EVALUATION KIT
AVAILABLE



RMS Power Detector

MAX2202

General Description

The MAX2202 RMS power detector is designed to operate from 800MHz to 2.0GHz. The device is ideal for wideband code-division multiple access (WCDMA), cdma2000®, and high-speed downlink/uplink packet access. The device accepts an RF signal at the input and outputs the same voltage regardless of the peak-average of the input signal. The output voltage and input power is linear in dB. The device has a -29dBm to 0dBm detection range, and every dB change in input power gives 33mV (typ) change in output voltage.

The device operates from a 2.5V to 4.2V supply and is specified over the -40°C to +85°C extended temperature range. The device is available in a 6-bump WLP package.

Applications

LTE, WCDMA, cdma2000, 1xEVDO
High-Speed Downlink Packet Access (HSDPA)
High-Speed Uplink Packet Access (HSUPA)

Features

- ◆ -29dBm to 0dBm Power-Detection Range
- ◆ 33mV/dB (typ) Log Detector
- ◆ 0.1dB (typ) RMS Accuracy from WCDMA Modulation Change
- ◆ ±0.4dB Detection Error Due to Temperature
- ◆ +2.5V to +4.2V Single-Supply Operation
- ◆ Space-Saving 6-Bump WLP Package

Ordering Information

PART	TEMP RANGE	PIN-PACKAGE	TOP MARK
MAX2202EWT+T10	-40°C to +85°C	6 WLP	AA

+ Denotes a lead (Pb)-free/RoHS-compliant package.
T = Tape and reel.

Typical Operating Circuit

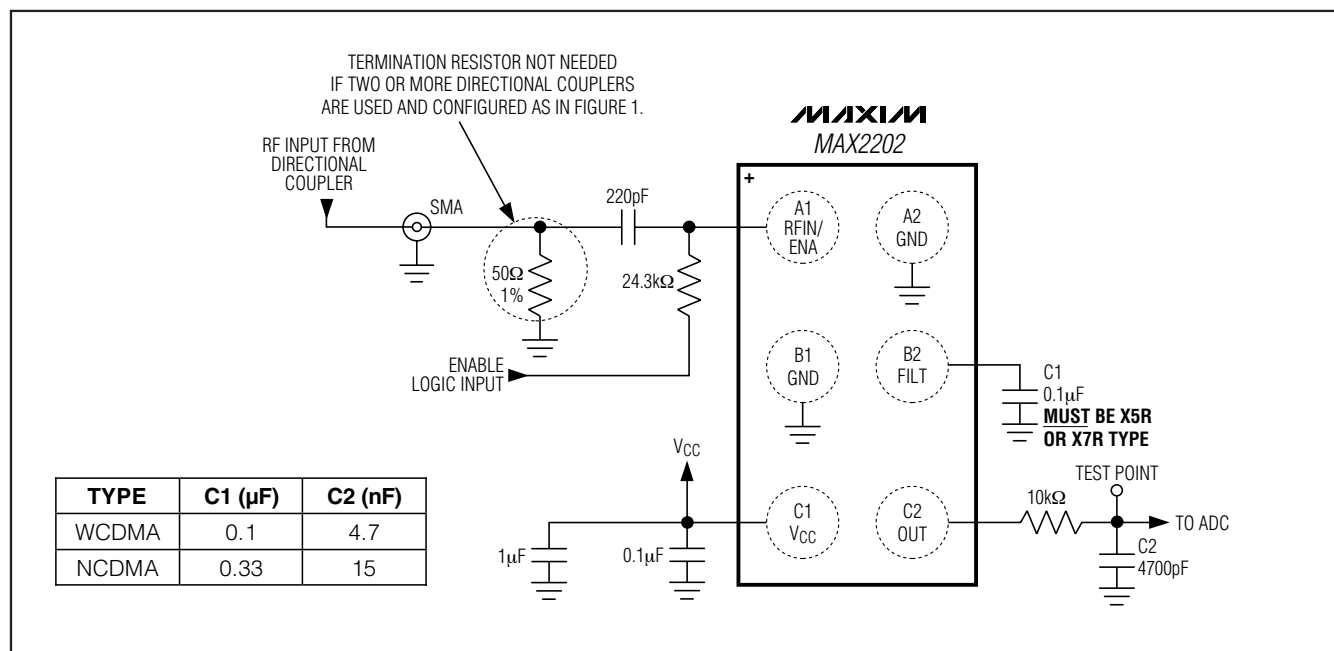

cdma2000 is a registered trademark of the Telecommunications Industry Association.



Maxim Integrated Products 1

For pricing, delivery, and ordering information, please contact Maxim Direct at 1-888-629-4642, or visit Maxim's website at www.maxim-ic.com.

RMS Power Detector

ABSOLUTE MAXIMUM RATINGS

V _{CC} to GND	-0.3V to +4.5V	Operating Temperature Range	-40°C to +85°C
ENA, OUT, FILT to GND	-0.3V to +3.0V	Storage Temperature Range	-65°C to +160°C
RFIN Input Power	+10dBm	Junction Temperature	+150°C
Continuous Power Dissipation (T _A = +70°C)		Soldering Temperature (reflow, Note 1).....	+260°C
6-Bump WLP (derate 2.9mW/°C above +70°C).....	232mW		

Note 1: Refer to Application Note 1891: *Wafer-level packaging (WLP) and its applications*.

Stresses beyond those listed under "Absolute Maximum Ratings" may cause permanent damage to the device. These are stress ratings only, and functional operation of the device at these or any other conditions beyond those indicated in the operational sections of the specifications is not implied. Exposure to absolute maximum rating conditions for extended periods may affect device reliability.



CAUTION! ESD SENSITIVE DEVICE

PACKAGE THERMAL CHARACTERISTICS (NOTES 2)

6 WLP

Junction-to-Ambient Thermal Resistance (θ_{JA})95°C/W

Note 2: Package thermal resistances were obtained using the method described in JEDEC specification JESD51-7, using a four-layer board. For detailed information on package thermal considerations, refer to www.maxim-ic.com/thermal-tutorial.

DC ELECTRICAL CHARACTERISTICS

(V_{CC} = 2.5V to 4.2V, T_A = -40°C to +85°C, V_{ENA} = 2.7V, no RF signal applied. Typical values are at V_{CC} = 2.8V, T_A = +25°C, unless otherwise noted.) (Note 3)

PARAMETER	SYMBOL	CONDITIONS	MIN	TYP	MAX	UNITS
Supply Voltage	V _{CC}		2.5	2.8	4.2	V
Supply Current	I _{CC}	V _{CC} = 2.8V, RF input = -29dBm to 0dBm		5.5	8.5	mA
Shutdown Supply Current		V _{ENA} = 0V		0.5	10	μA
ENA Logic-High Threshold	V _{IH}		1.1		2.7	V
ENA Logic-Low Threshold	V _{IL}		0		0.6	V
ENA Input Current		V _{ENA} = 1.1V or 0.6V		25		μA

AC ELECTRICAL CHARACTERISTICS

(V_{CC} = 2.8V, T_A = -40°C to +85°C, V_{ENA} = 2.7V, f_{RF} = 800MHz to 2GHz, unless otherwise noted. Typical values are at T_A = +25°C.) (Note 3)

PARAMETER	SYMBOL	CONDITIONS	MIN	TYP	MAX	UNITS
RF Input Frequency			800		2000	MHz
Maximum Output Voltage		RFIN at 0dBm	1.05	1.3	1.5	V
Minimum Output Voltage		No RF input power, V _{ENA} = 2.7V		250	450	mV
Minimum Input Power Level		+1dB input power step results in V _{OUT} increase > 23mV/dB (Note 4)			-29	dBm
Log Slope		[(V _{OUT} at -1dBm) - (V _{OUT} at -29dBm)]/28	23	33	43	mV/dB
Log Conformance Error with 10dB Step		(Notes 4, 5)	-1.0		+1.0	dB
Power-Detector Accuracy Due to Temperature		RF input at -4dBm to -1dBm, T _A = -20°C to +25°C, and T _A = +25°C to +85°C		±0.4		dB

Note 3: Guaranteed by production test at T_A = +85°C and 800MHz. Guaranteed by design and characterization at T_A = -40°C and T_A = +25°C, and over frequency limits.

Note 4: Guaranteed by design and characterization.

Note 5: Log conformance is defined with respect to 4 calibration points, -1dBm, -7dBm, -19dBm, and -29dBm, at T_A = +25°C.

RMS Power Detector

Typical Operating Characteristics

($V_{CC} = 2.7V$, $T_A = +25^\circ C$, WCDMA uplink DPCCH + 1DPDCH, log conformance calculation is referenced to a straight line that is calibrated at -20dBm and 0dBm, unless otherwise noted.)

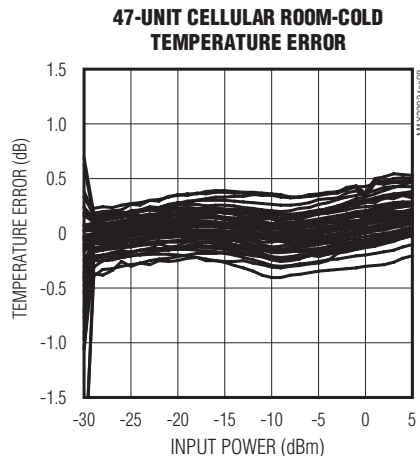
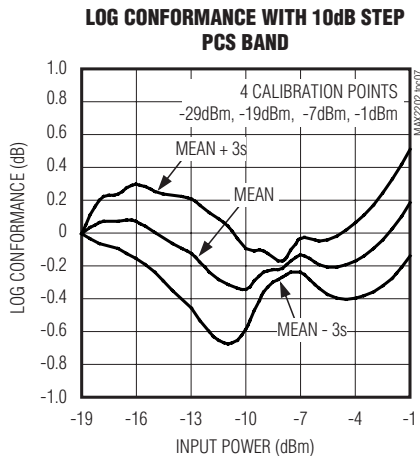
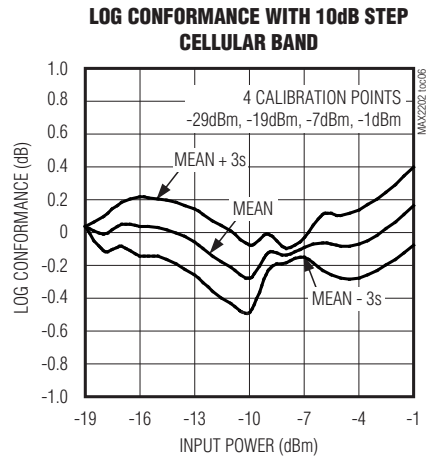
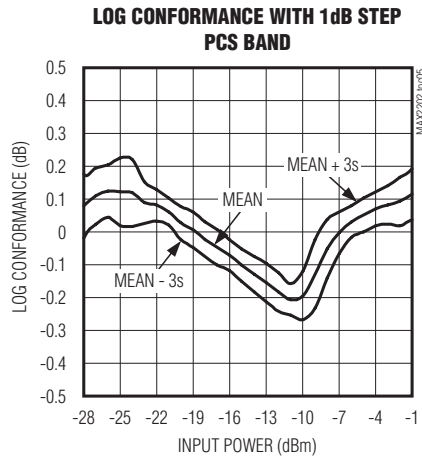
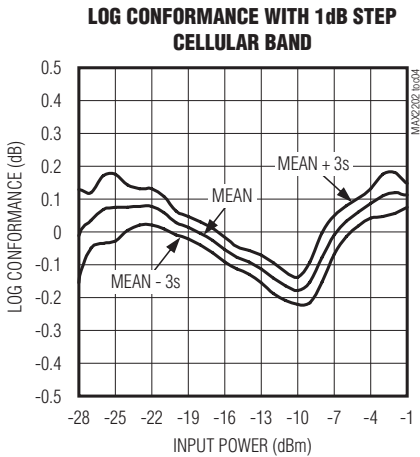
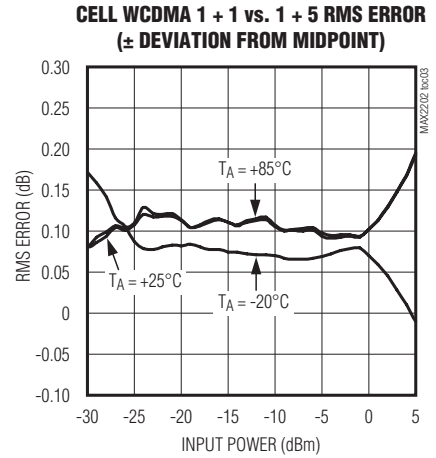
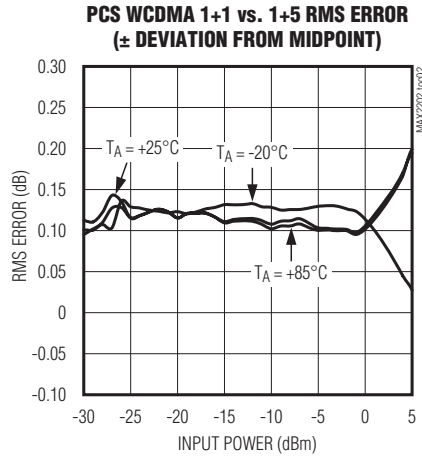
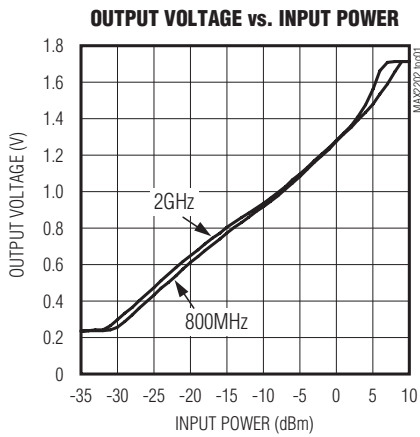

RMS Power Detector

Typical Operating Characteristics (continued)

($V_{CC} = 2.7V$, $T_A = +25^\circ C$, WCDMA uplink DPCCH + 1DPDCH, log conformance calculation is referenced to a straight line that is calibrated at -20dBm and 0dBm, unless otherwise noted.)

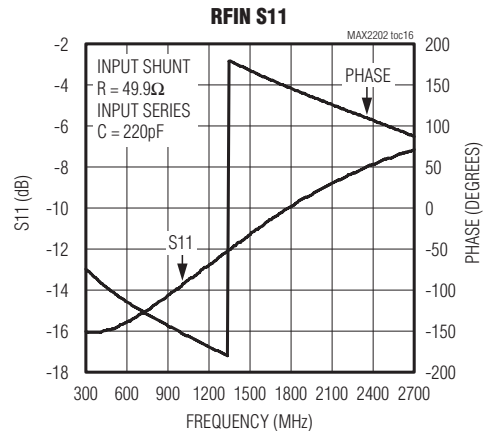
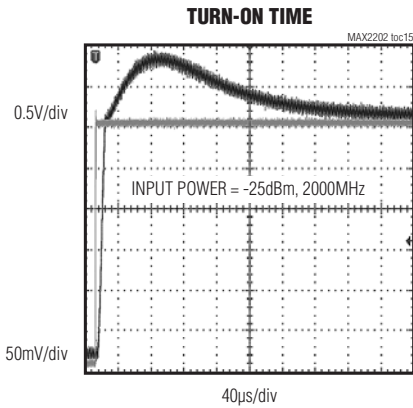
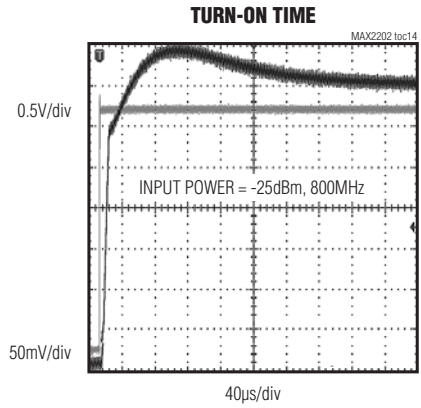
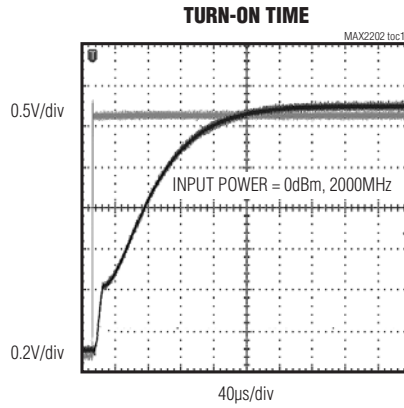
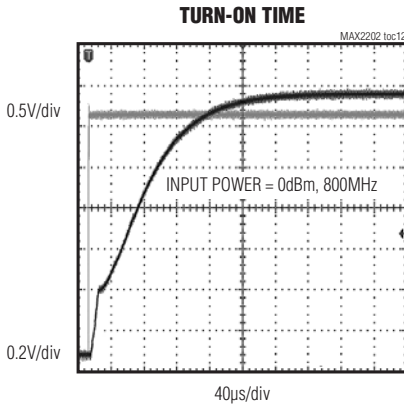
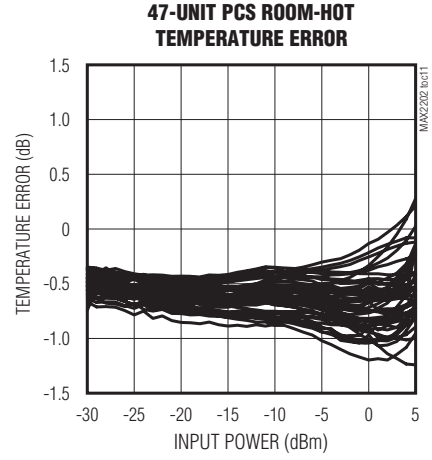
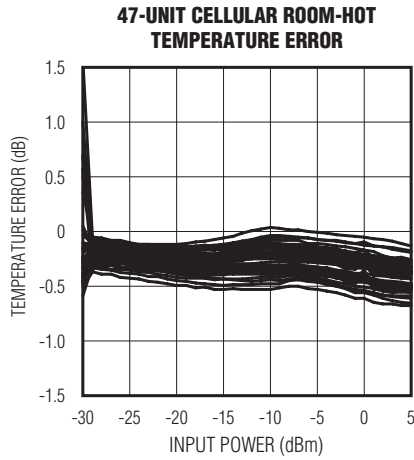
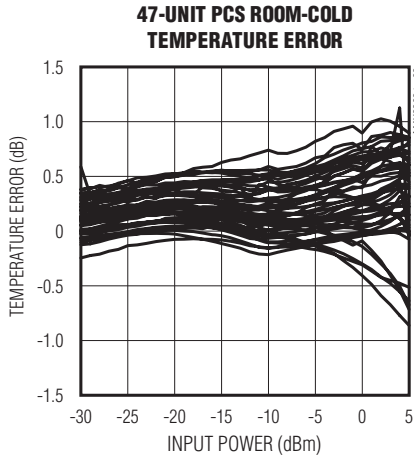

RMS Power Detector

Bump Configuration

MAX2202

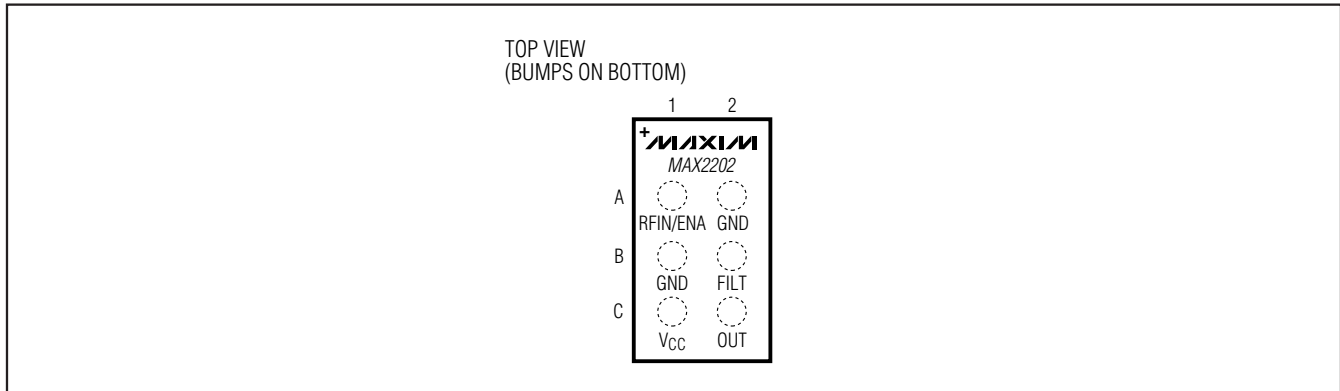

Bump Description

BUMP	NAME	FUNCTION
A1	RFIN/ENA	RF Input and Enable Logic Input. See the <i>Typical Operating Circuit</i> . Drive ENA high to turn on the device. Drive ENA low to place it in shutdown mode.
A2, B1	GND	Ground. Connect to PCB ground plane.
B2	FILT	Intermediate Filtering Node. Bypass FILT with a capacitor as close as possible to the device.
C1	VCC	Power Supply. Connect to either a regulated supply or battery. Bypass VCC with a capacitor as close as possible to the device.
C2	OUT	Detector Output. Connect an external lowpass RC filter for filtering.

Detailed Description

The MAX2202 RMS power detector is designed to operate from 800MHz to 2.0GHz. The device is ideal for LTE, WCDMA, cdma2000, and high-speed downlink/uplink packet access. The device accepts an RF signal at the input and outputs the same voltage regardless of

the peak-average of the input signal. The output voltage and input power is linear in dB. The device has a -29dBm to 0dBm detection range, and every dB change in input power gives 33mV (typ) change in output voltage. Table 1 shows the peak to average of the signals used to test the device.

Table 1. Peak-to-Average Ratio (PAR*) of Test Signals

MODULATION	PAR AT DIFFERENT PROBABILITY OF COMPLEMENTARY CUMULATIVE DISTRIBUTION (dB)			
	10%	1%	0.1%	0.01%
DPCCH + 1DPDCH	4.8	5.8	6.2	6.5
DPCCH + 5DPDCH	6.5	8.4	9.2	9.8
IS95 Reverse	5.5	6.9	7.6	8.1
IS95 Forward Pilot	5.6	7.6	8.8	9.5
9-Channel Forward	7	10.3	12	12.7
cdma2000 Pilot + DCCH	6.8	8.3	9.2	9.7

*PAR of CW is 3dB.

RMS Power Detector

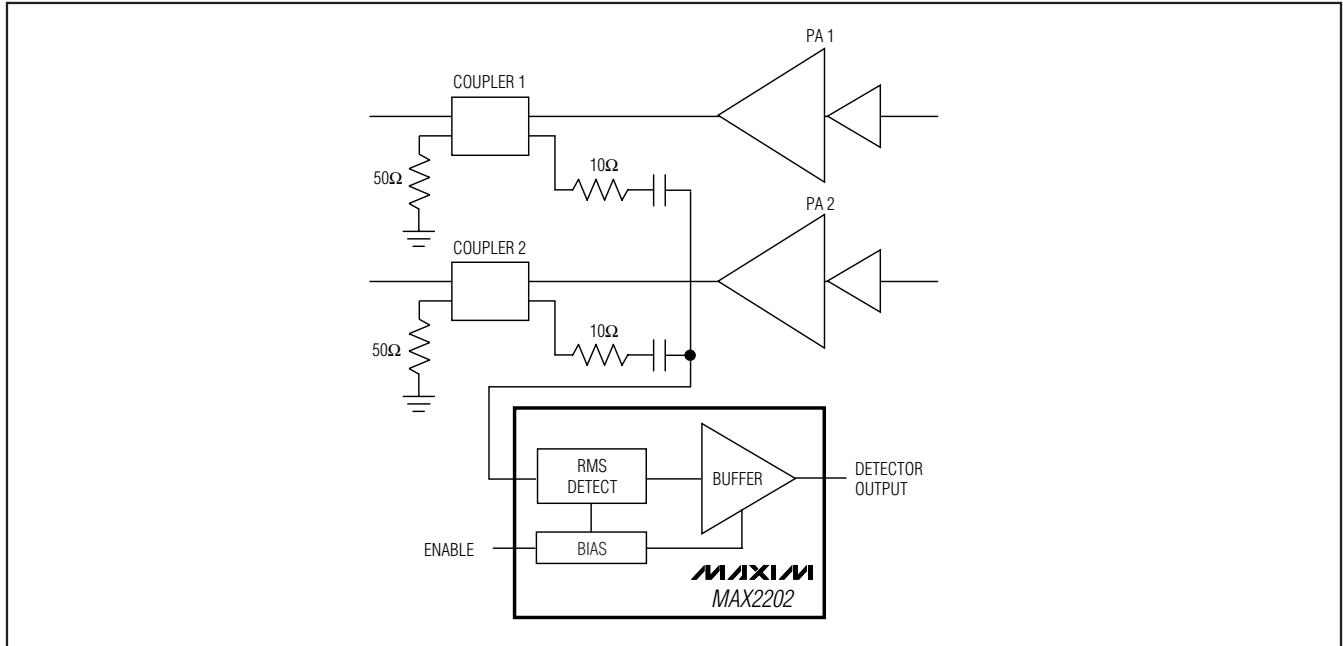

Figure 1. System Level Connection

Applications Information

Detector RF Input

The MAX2202 generally requires a terminating resistor and series capacitor between the directional coupler's output and detector RF input. As shown in the *Typical Operating Characteristics*, an S11 of less than -9dB is possible when a terminating resistor of 50Ω and series capacitor of 220pF are used at the input. S11 of the MAX2202 RFIN port without input matching is shown in Table 2 and can be downloaded from Maxim's website.

In cases where the detector is connected to two or more directional couplers, as shown in Figure 1, the 50Ω terminating resistor can be eliminated.

Detector Voltage Output

The output of the MAX2202 goes to an ADC for further processing by the baseband system. Connect a series 10kΩ resistor and a shunt capacitor to the detector output to reduce residual amplitude ripple. The shunt capacitor should be 4.7nF for WCDMA and 15nF for NCDMA.

Enable Logic Level

The device features an enable input (ENA) that allows the device to be put into shutdown. For normal operation, drive ENA high. For device shutdown, drive ENA low. The ENA pin is DC biased through a resistor. The value of the resistor is recommended to be greater than

Table 2. RF Input S11

FREQ (MHz)	S11 (dB)	S11 (PHASE)	FREQ (MHz)	S11 (dB)	S11 (PHASE)
300	-1.63	-34.1	1560	-1.37	-156.4
360	-1.69	-39.6	1620	-1.35	-162.4
420	-1.75	-44.9	1680	-1.35	-168.0
480	-1.77	-50.2	1740	-1.35	-173.7
540	-1.77	-55.9	1800	-1.36	-179.2
600	-1.75	-61.4	1860	-1.36	175.3
660	-1.74	-66.9	1920	-1.41	170.0
720	-1.72	-72.6	1980	-1.35	164.8
780	-1.70	-78.6	2040	-1.37	159.6
840	-1.62	-84.2	2100	-1.34	154.5
900	-1.59	-90.2	2160	-1.36	149.2
960	-1.53	-96.2	2220	-1.37	144.2
1020	-1.52	-102.2	2280	-1.37	139.2
1080	-1.45	-108.4	2340	-1.39	134.5
1140	-1.46	-114.5	2400	-1.37	129.5
1200	-1.40	-120.5	2460	-1.39	124.7
1260	-1.40	-126.5	2520	-1.38	119.9
1320	-1.39	-132.6	2580	-1.40	115.2
1380	-1.37	-138.9	2640	-1.39	110.4
1440	-1.35	-144.6	2700	-1.40	105.7
1500	-1.37	-150.6	—	—	—

Note: VCC = 2.8V, S11 measured at RFIN bump.

RMS Power Detector

1k Ω to avoid loading the RF input signal. There is an internal resistor to GND of approximately 50k Ω . If the control source high voltage is greater than 2.8V, calculate and use a resistor value that ensures the ENA pin only sees a maximum of 2.7V, which is within specification. In this manner, the device can be driven from a control device with a logic-high greater than 2.8V.

Evaluation Kit Information

MAX2202 EV kit gerber files, schematic, BOM, and other updates are available on the MAX2202 product page at Maxim's website (www.maxim-ic.com).

Layout

The device is not particularly sensitive to the layout since it only needs 3dBm for maximum output voltage. However, there are two areas that need attention: the GND pins and the supply bypassing. Connect the GND pins to the PCB ground with a ground via as close as possible, and bypass VCC to ground with a capacitor as close as possible to the part.

Chip Information

PROCESS: BiCMOS

Package Information

For the latest package outline information and land patterns (footprints), go to www.maxim-ic.com/packages. Note that a "+", "#", or "-" in the package code indicates RoHS status only. Package drawings may show a different suffix character, but the drawing pertains to the package regardless of RoHS status.

PACKAGE TYPE	PACKAGE CODE	OUTLINE NO.	LAND PATTERN NO.
6 WLP	W61B1+1	21-0217	Refer to Application Note 1891

RMS Power Detector

Revision History

REVISION NUMBER	REVISION DATE	DESCRIPTION	PAGES CHANGED
0	9/10	Initial release	—
1	2/11	Updated Log Conformance Error with 10dB Step specifications in <i>AC Electrical Characteristics</i> ; updated TOC 6 and 7 in <i>Typical Operating Characteristics</i>	2, 3

Maxim cannot assume responsibility for use of any circuitry other than circuitry entirely embodied in a Maxim product. No circuit patent licenses are implied. Maxim reserves the right to change the circuitry and specifications without notice at any time.

8 _____ **Maxim Integrated Products, 120 San Gabriel Drive, Sunnyvale, CA 94086 408-737-7600**

X-ON Electronics

Largest Supplier of Electrical and Electronic Components

Click to view similar products for [RF Detector](#) category:

Click to view products by [Maxim](#) manufacturer:

Other Similar products are found below :

[Maxim](#)