

Click [here](#) to ask about production status of specific part numbers.

## MAX22191

## Ultra-Low-Power, Parasitically Powered Digital Input

### General Description

The MAX22191 is an IEC 61131-2 compliant, industrial digital input (DI) device. The MAX22191 translates a 24V industrial switching signal to a 3.3V/5V CMOS-level output, or to a 2.3mA (typ) current output for driving an optocoupler and/or LED. Voltage thresholds and current levels in the MAX22191 are compliant with Type 1 and Type 3 inputs, while minimizing power dissipation. The MAX22191 is also compliant with 48V inputs, with the addition of external resistors.

Operating power is derived from the input signal, eliminating the need for an external field-side power supply. A 250ns (max) fast response time is ideal for high-speed inputs. Additionally, a CMOS-compatible test input is available for safety diagnostics.

The MAX22191 features robust functionality for harsh industrial systems and is capable of normal operation with input signals ranging from -60V to +60V. Integrated thermal shutdown further protects the device when  $V_{CC}$  is present.

The MAX22191 is available in a small, 6-lead SOT23 package and operates over the -40°C to +125°C ambient temperature range.

### Applications

- Process Automation
- Industrial Automation
- Motor Controls
- Individually Isolated Inputs
- Current Sourcing Inputs

### Simplified Block Diagram

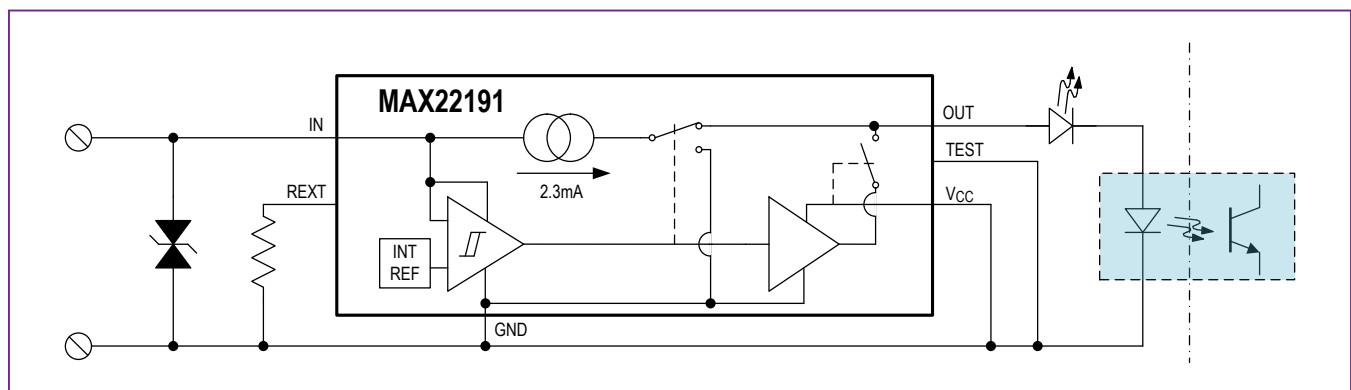

### Benefits and Features

- High Integration for Flexible Circuit Designs
  - Interfaces to Optocouplers or Digital Isolators
  - Capable of Driving an Optocoupler and Status LED
  - Operational as Sink or Source Digital Input
  - Ultra-High Speed: 250ns (max) Propagation Delay
  - Test Pulse Diagnostic
  - Allows for Small Footprint TVS Surge Protection
- Reduced Power and Heat Dissipation
  - Parasitically Powered from the Field Input
  - Accurate  $\pm 15\%$  Input-Current Limiting
  - 100 $\mu$ A (typ) Quiescent Current with Optocoupler
  - 96% (typ) Current-Transfer Efficiency to Optocoupler
- Robust Design
  - Operates from -60V to +60V Input Voltage
  - -40°C to +125°C Ambient Operating Temperature

Ordering Information appears at end of data sheet.

### Absolute Maximum Ratings

(All voltages referenced to GND, unless otherwise stated)

V <sub>CC</sub> .....	-0.3V to +6V
IN .....	-70V to +60V
TEST .....	-0.3V to +6V
OUT (3.0V ≤ V <sub>CC</sub> ≤ 5.5V) .....	-0.3V to (V <sub>CC</sub> + 0.3V)
OUT (V <sub>CC</sub> = 0V).....	-0.3V to min [(V <sub>IN</sub> + 0.3V), +6V]
REXT (3.0V ≤ V <sub>CC</sub> ≤ 5.5V) .....	-0.3V to (V <sub>CC</sub> + 0.3V)
REXT (V <sub>CC</sub> = 0V).....	-0.3V to min [(V <sub>IN</sub> + 0.3V), +6V]
Short-Circuit Duration	
OUT to GND .....	Continuous

Continuous Power Dissipation (T <sub>A</sub> = +70°C)	
6L SOT23 (derate at 8.7mW/°C above +70°C) .....	696mW
Operating Temperature Range	
Ambient Temperature .....	-40°C to +125°C
Junction Temperature .....	+150°C
Storage Temperature Range .....	-65°C to +150°C
Lead Temperature (soldering, 10s) .....	+300°C
Soldering (reflow) .....	+260°C

Stresses beyond those listed under "Absolute Maximum Ratings" may cause permanent damage to the device. These are stress ratings only, and functional operation of the device at these or any other conditions beyond those indicated in the operational sections of the specifications is not implied. Exposure to absolute maximum rating conditions for extended periods may affect device reliability.

### Package Information

<b>PACKAGE TYPE: 6 SOT23</b>	
Package Code	U6-1
Outline Number	<a href="#">21-0058</a>
Land Pattern Number	<a href="#">90-0175</a>
<b>THERMAL RESISTANCE, FOUR-LAYER BOARD</b>	
Junction to Ambient (θ <sub>JA</sub> )	115°C/W
Junction to Case (θ <sub>JC</sub> )	80°C/W

Package thermal resistances were obtained using the method described in JEDEC specification JESD51-7, using a four-layer board. For detailed information on package thermal considerations, refer to [www.maximintegrated.com/thermal-tutorial](http://www.maximintegrated.com/thermal-tutorial).

For the latest package outline information and land patterns (footprints), go to [www.maximintegrated.com/packages](http://www.maximintegrated.com/packages). Note that a "+", "#", or "-" in the package code indicates RoHS status only. Package drawings may show a different suffix character, but the drawing pertains to the package regardless of RoHS status.

## DC Electrical Characteristics

$V_{IN} = 0V$  to  $60V$ ,  $V_{CC} = 0V$ ,  $T_A = -40^{\circ}C$  to  $+125^{\circ}C$ , unless otherwise noted. Typical values are at  $V_{IN} = 24V$ ,  $R_{EXT} = 40.2k\Omega$  ( $\pm 1\%$ ), and  $T_A = +25^{\circ}C$ . (Notes 1, 2)

PARAMETER	SYMBOL	CONDITIONS		MIN	TYP	MAX	UNITS
<b>DIGITAL INPUT (IN)</b>							
IN Functional Operating Range	$V_{IN\_F}$			-60		+60	V
IN Voltage Upper Threshold	$V_{INTHU}$	OUT is high	$V_{CC} = 0V$			10	V
			$3.0V \leq V_{CC} \leq 5.5V$ (Note 3)			10	
IN Voltage Lower Threshold	$V_{INTHL}$	OUT is low	$V_{CC} = 0V$	7			V
			$3.0V \leq V_{CC} \leq 5.5V$ (Note 3)	7			
IN Current Low	$I_{INL}$	$V_{IN} = 7V$ , steady state, $R_{EXT} = 40.2k\Omega$ , $V_{OUT} = 3V$	$V_{CC} = 0V$	1.5			mA
			$3.0V \leq V_{CC} \leq 5.5V$ (Note 3)	1.5			
IN Boost Current	$I_{INB}$	$V_{IN} < V_{INTHU}$ (Note 4)			4	5.5	mA
IN Current High	$I_{INH}$	$V_{IN} = 10V$ to $36V$ , steady state, $R_{EXT} = 40.2k\Omega$	$V_{CC} = 0V$ $V_{OUT} = 0V$ to $5.5V$	2.1	2.4	2.7	mA
			$3.0V \leq V_{CC} \leq 5.5V$ (Note 3)	2.1		2.75	
<b>OUTPUT (OUT)</b>							
OUT High Current	$I_{OUTH}$	$V_{OUT} = 0.5V$ to $5.5V$ , $V_{IN} = 10V$ , $V_{CC} = 0V$		2	2.3		mA
OUT Low Current	$I_{OUTL}$	$V_{IN} < V_{INTHL}$ , $V_{OUT} = 0V$		-1		+1	$\mu A$
OUT Voltage High	$V_{OH}$	$3.0V \leq V_{CC} \leq 5.5V$ , $I_{LOAD} = 1mA$ (Note 3)		$V_{CC} - 0.4$			V
OUT Voltage Low	$V_{OL}$	$3.0V \leq V_{CC} \leq 5.5V$ , $I_{SINK} = 1mA$ (Note 3)				0.4	V
<b>AUXILIARY POWER SUPPLY (<math>V_{CC}</math>)</b>							
Auxiliary Power Supply Range	$V_{CC}$	(Note 5)		3.0		5.5	V
Auxiliary Power Supply Current	$I_{CC}$	$V_{CC} = 3.0V$			270	400	$\mu A$
		$V_{CC} = 5.5V$			380	600	
<b>TEST INPUT</b>							
TEST Input High Threshold	$V_{TESTH}$	$3.0V \leq V_{CC} \leq 5.5V$				$(2/3)V_{CC}$	V
		$V_{CC} = 0V$				2.8	
TEST Input Low Threshold	$V_{TESTL}$	$3.0V \leq V_{CC} \leq 5.5V$		$V_{CC}/3$			V
		$V_{CC} = 0V$		1.3			
TEST Input Pulldown Resistance	$R_{PD}$				250		k $\Omega$
<b>PROTECTION</b>							
Thermal Shutdown Threshold	$T_{SHDN}$	(Note 6)			160		$^{\circ}C$
Thermal Shutdown Hysteresis	$T_{SHDN\_HYS}$				23		$^{\circ}C$
ESD (All Pins)		Human Body Model			$\pm 2$		kV

AC Electrical Characteristics

$V_{IN} = 0V$  to  $60V$ ,  $V_{CC} = 0V$ ,  $T_A = -40^{\circ}C$  to  $+125^{\circ}C$ , unless otherwise noted. Typical values are at  $V_{IN} = 24V$ ,  $R_{EXT} = 40.2k\Omega$  ( $\pm 1\%$ ), and  $T_A = +25^{\circ}C$ . (Note 1)

PARAMETER	SYMBOL	CONDITIONS		MIN	TYP	MAX	UNITS
IN to OUT Low-to-High Propagation Delay	$t_{PDLH}$	$C_L = 15pF$ , Figure 1	$V_{CC} = 0V$ , $R_L = 1.5k\Omega$			250	ns
			$V_{CC} = 3.0V$ , $R_L$ is open			200	
IN to OUT High-to-Low Propagation Delay	$t_{PDHL}$	$C_L = 15pF$ , Figure 1	$V_{CC} = 0V$ , $R_L = 1.5k\Omega$			250	ns
			$V_{CC} = 3.0V$ , $R_L$ is open			200	
IN to OUT Propagation Delay Jitter		$C_L = 15pF$ , RMS jitter, Figure 1			250		ps
IN to OUT Propagation Delay Skew, Part-to-Part	$t_{SKEWP2P}$	$C_L = 15pF$ , Figure 1 (Note 5)	$V_{CC} = 0V$ , $R_L = 1.5k\Omega$ ,			195	ns
			$3.0V \leq V_{CC} \leq 5.5V$ , $R_L$ is open			75	
TEST Propagation Delay		$V_{CC} = 0V$ or $3V$ , $V_{IN} = 11V$	TEST low to high, OUT high to low		1.5		$\mu s$
			TEST high to low, OUT low to high		1.8		

- Note 1:** All units are production tested at  $T_A = +25^{\circ}C$ . Specifications over temperature are guaranteed by design and characterization.
- Note 2:** All voltages are referenced to ground, unless otherwise noted.
- Note 3:**  $V_{CC}$  is an auxiliary supply input. When  $V_{CC}$  is powered from an external 3V to 5.5V supply, the propagation delay is reduced and the output changes from a current source to a CMOS output. When using power from IN to power the device, connect  $V_{CC}$  to GND ( $V_{CC} = 0V$ ).
- Note 4:** See the [Boost Current](#) section for more information.
- Note 5:** Not production tested. Guaranteed by design
- Note 6:** Thermal shutdown protection is only enabled when  $V_{CC}$  is present. Thermal shutdown does not occur when  $V_{CC} = 0V$ .

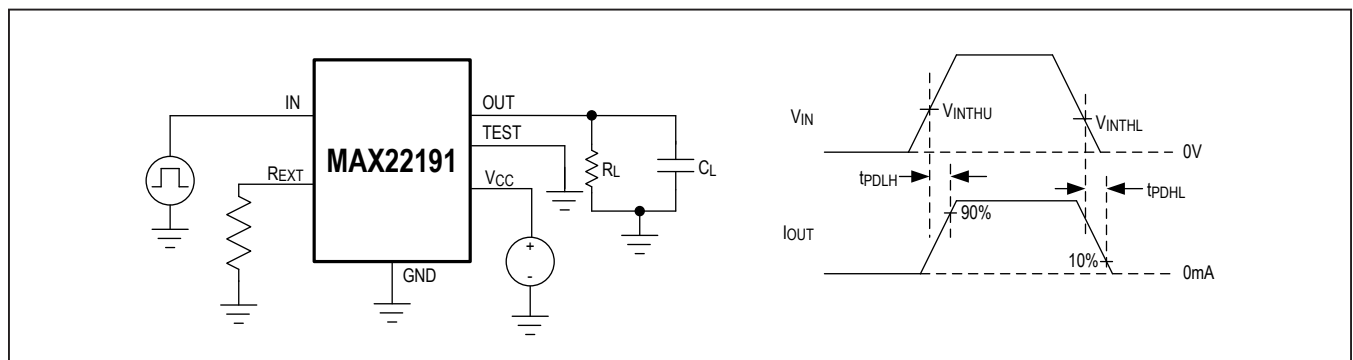
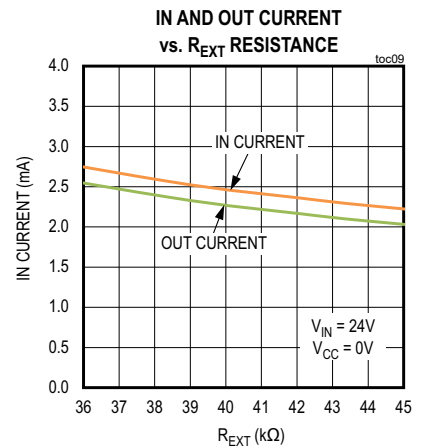
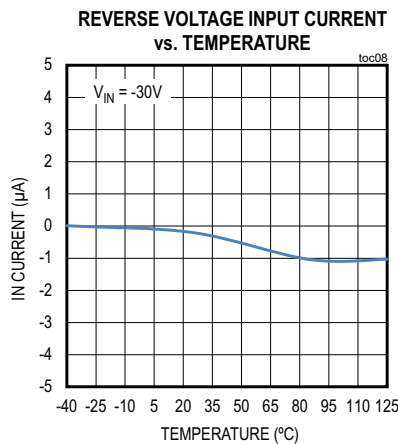
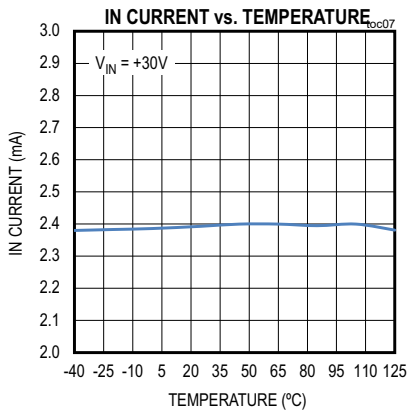
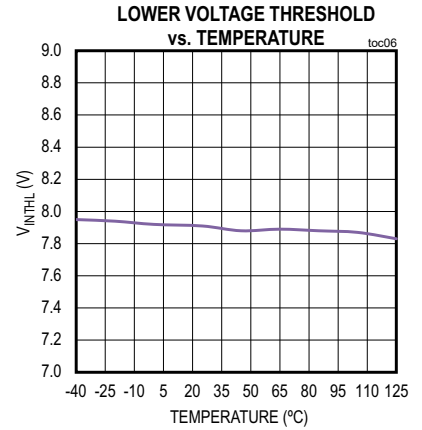
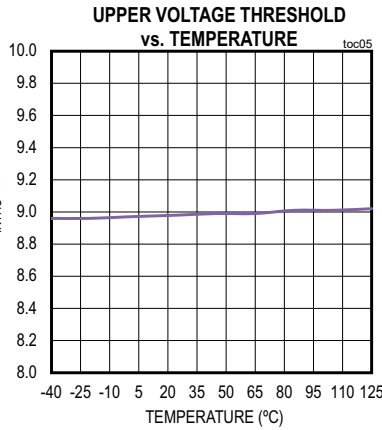
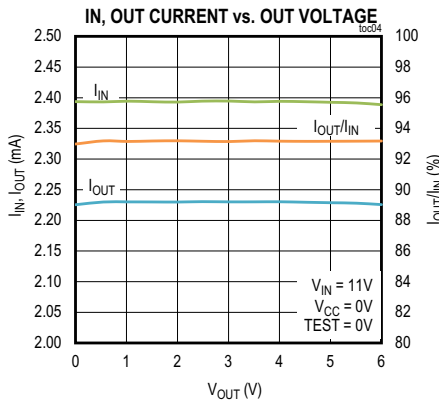
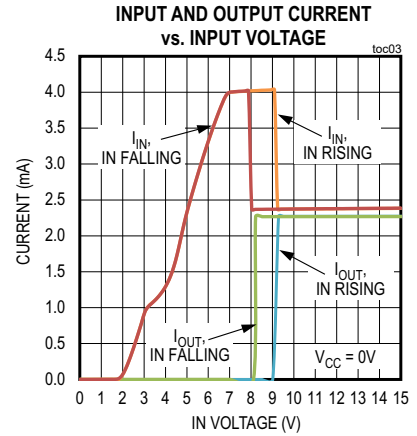
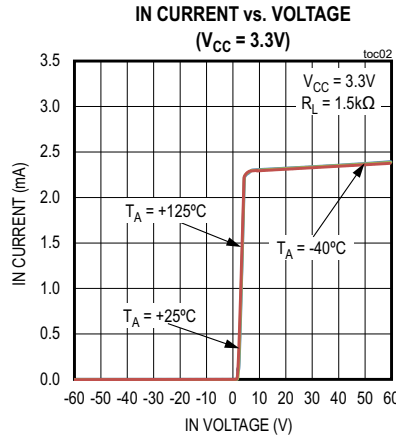
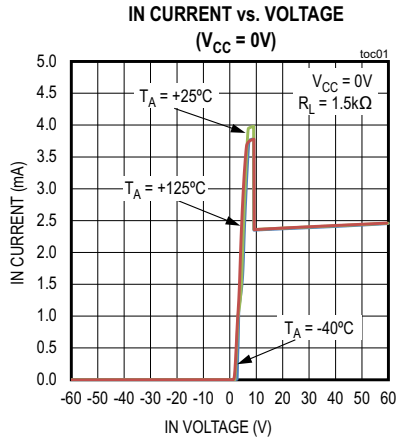

Figure 1. Propagation Delay Test Circuit and Timing Diagram

Typical Operating Characteristics

( $V_{IN} = 24V$ ,  $R_{EXT} = 40.2k\Omega (\pm 1\%)$ ,  $R_L = 1.5k\Omega$  on OUT,  $T_A = +25^\circ C$ , unless otherwise noted.)



Typical Operating Characteristics (continued)

( $V_{IN} = 24V$ ,  $R_{EXT} = 40.2k\Omega$  ( $\pm 1\%$ ),  $R_L = 1.5k\Omega$  on OUT,  $T_A = +25^\circ C$ , unless otherwise noted.)

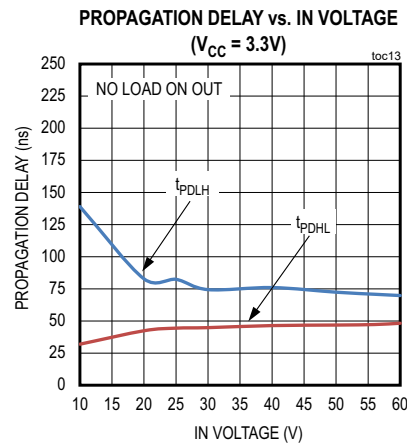
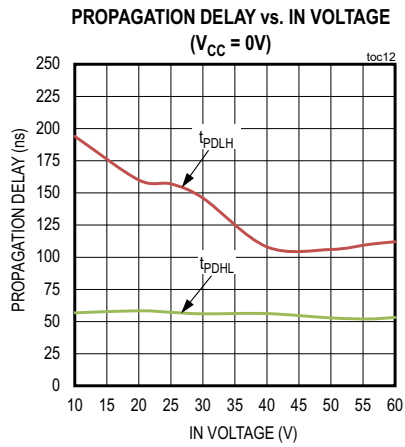
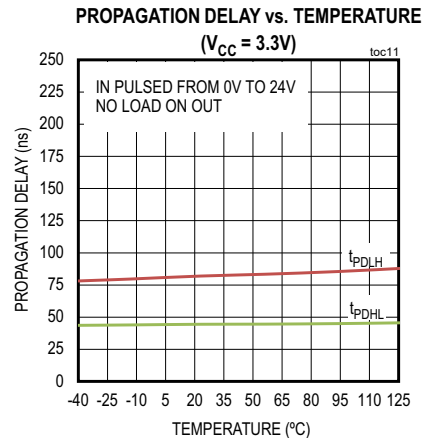
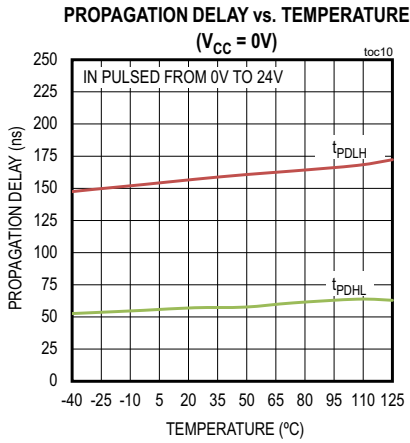

Pin Configurations

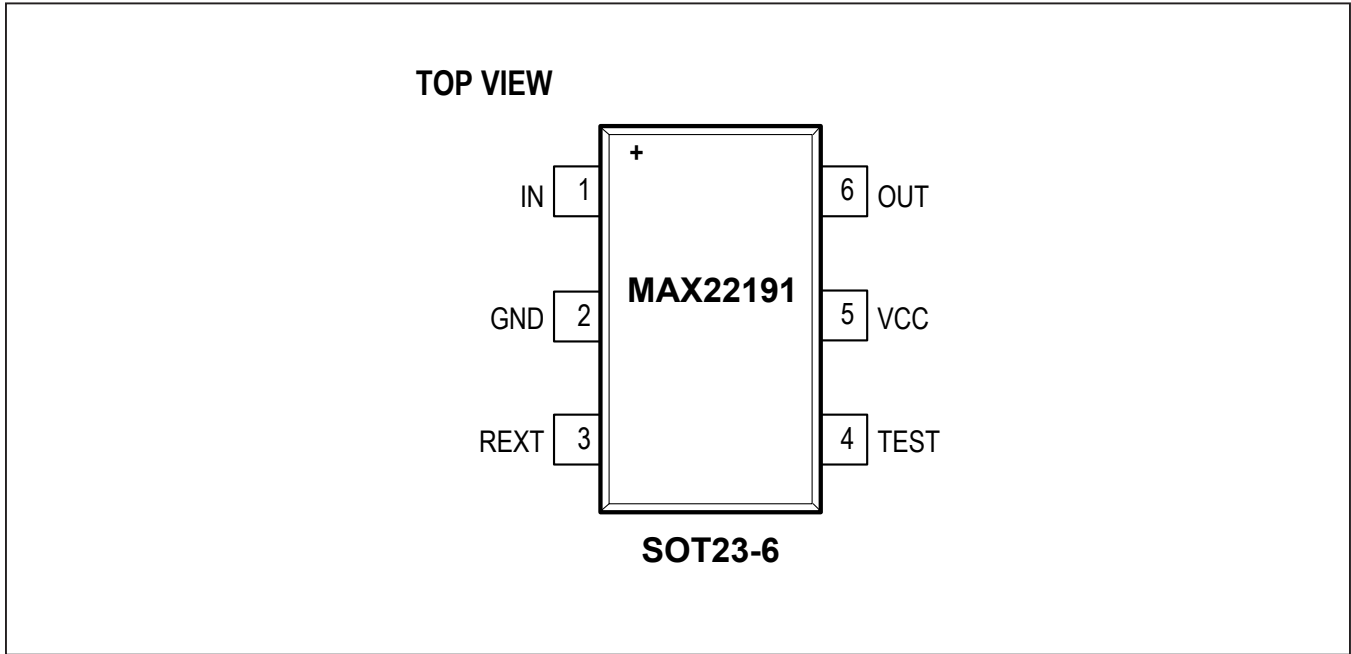

Pin Description

PIN	NAME	FUNCTION
1	IN	Digital Input. Connect IN directly to the input signal. Connect suitable TVS between IN and GND for surge protection.
2	GND	Ground
3	REXT	Reference Current Resistor Connection. Connect an external 40.2kΩ (±1%) resistor between REXT and GND.
4	TEST	Test Pulse Input. When IN is high, toggle TEST from low-to-high to verify that OUT toggles from high-to-low.
5	VCC	Auxiliary Supply Input. For a parasitically powered circuit, connect VCC to GND. To power the device from a local power supply, connect VCC to a 3.0V to 5.5V source. Bypass VCC to GND with a 1µF capacitor when powered from a local supply.
6	OUT	Output Signal. Connect OUT to the anode of an optical LED, or to the input of a digital circuit.

## Detailed Description

The MAX22191 features an integrated current source, voltage comparator, and current steering network to create an input load compliant with IEC 61131-2 Type 1 and Type 3 24V<sub>DC</sub> inputs, while generating a drive current for optoisolators that turn-on/off in compliance with the voltage thresholds of the standard. The addition of external voltage-dropping resistors also allows the MAX22191 to operate with 48V<sub>DC</sub> inputs (see the [Typical Operating Circuits](#)).

### Power-Up/Power-Down

As the input voltage ( $V_{IN}$ ) rises, the MAX22191 transitions through three phases of operation:

**Phase 1:**  $V_{IN}$  is rising but is inadequate to fully power the current source or voltage comparator. Any current that does flow into the MAX22191 is diverted to GND through the internal current steering switches, bypassing the optical isolator.

**Phase 2:**  $V_{IN}$  continues to increase to a level that is adequate to power the comparator and the current source, but the input voltage threshold has not been reached. The output of the internal current source continues to be diverted to GND.

**Phase 3:**  $V_{IN}$  exceeds the comparator threshold ( $V_{INTHU}$ ), and the current is switched to the OUT pin. If connected to an external optical isolator, the current passes through the LED and returns to the negative field input.

As  $V_{IN}$  drops, the phases are reversed. The internal current source is switched from OUT to GND when  $V_{IN}$  falls below the lower voltage threshold ( $V_{INTHL}$ ).

### Boost Current

To allow for a faster response time, the MAX22191 includes a boost current,  $I_{INB}$ , during IN power up. The boost current is used to set and stabilize the output current while the voltage on IN is rising ( $V_{IN} < V_{INTHU}$ ). When  $V_{IN} > V_{INTHU}$ , and the output current is enabled, the input current is the sum of both the output current and boost current ( $I_{INB} + I_{INH}$ ) for a short period before the output current is steady at 2.3mA (typ).

### Integrated Diagnostic (TEST) Input

The MAX22191 features an integrated TEST input for easy diagnostic checks. When IN is high, toggle TEST from low-to-high to verify that OUT toggles high-to-low. See [Table 1](#). The current on IN is not affected during this diagnostic test.

When IN is low, TEST has no effect on OUT, it remains low.

**Table 1. TEST Mode Functionality**

IN	TEST	OUT
$< V_{INTHL}$	Low	Low
$< V_{INTHL}$	High	Low
$\geq V_{INTHU}$	Low	High
$\geq V_{INTHU}$	High	Low



**Applications Information**

**Powering the MAX22191 With the V<sub>CC</sub> Pin**

The MAX22191 can be powered parasitically from a digital input or from an external power supply.

To power the device parasitically, connect V<sub>CC</sub> to GND. In this configuration, power is derived from the signal on the IN pin.

To power the device from a local power supply, connect V<sub>CC</sub> to a source between 3.0V and 5.5V. When V<sub>CC</sub> is powered, the output (OUT) changes from a current source to a CMOS output and the propagation delay from IN to OUT is reduced.

**Connecting a Status/Indicator LED**

The MAX22191 output (OUT) is capable of driving an external status/indicator LED, as required in the IEC

61131-2 standard, when the device is powered. Figure 2 is an example of a current sinking configuration with a status/indicator LED in the output line. When the input voltage is above the voltage upper threshold ( $V_{IN} > V_{INTHU}$ ), the status LED is ON. When the input voltage is below the input lower threshold ( $V_{IN} < V_{INTHL}$ ), the status LED is OFF.

**Layout Considerations**

Place the 40.2kΩ (±1%) REXT resistor as close to the pin as possible. Too much distance between the resistor and the IC can create unwanted input current overshoots/undershoots.

**EMI Protection**

The MAX22191 must be protected against surge and ESD. Connect a bidirectional TVS between IN and GND that limits the the peak absolute input voltage to under 60V. Example TVS' are SMAJ33A, SPT02-236, PDFN3-32.

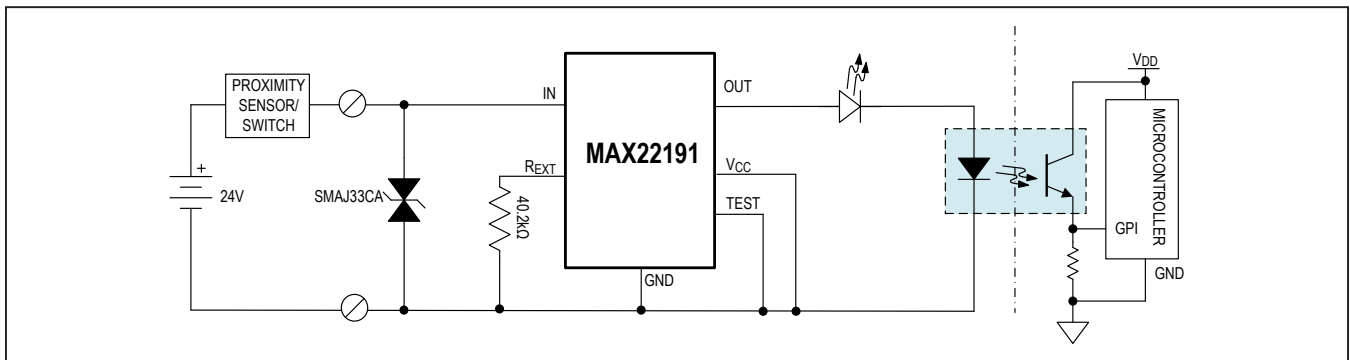
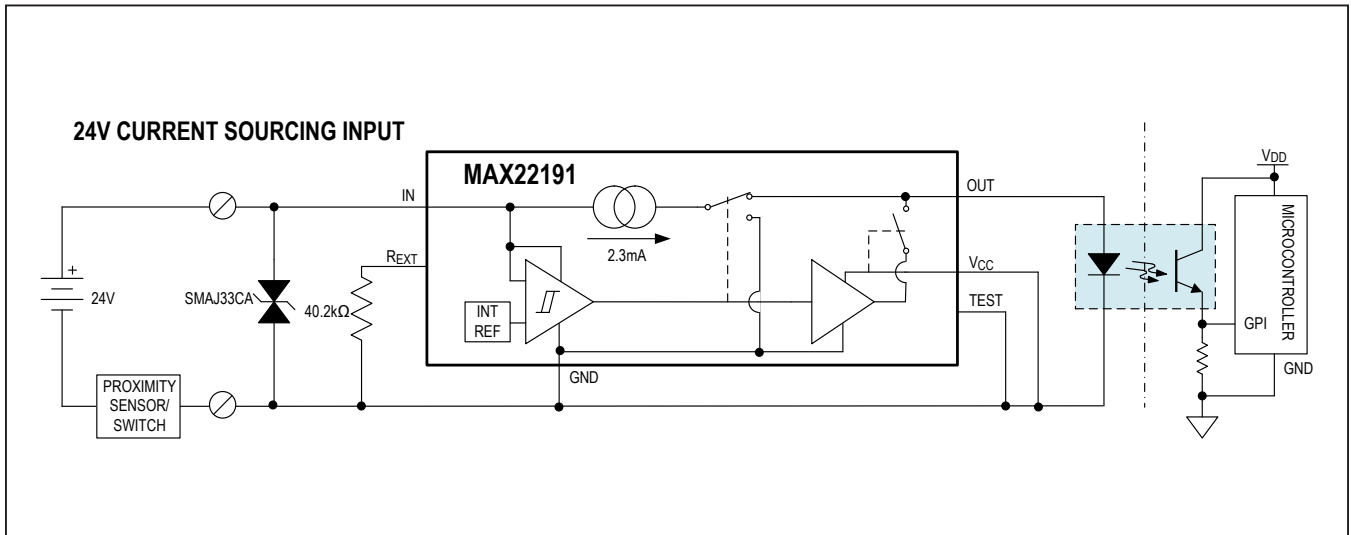
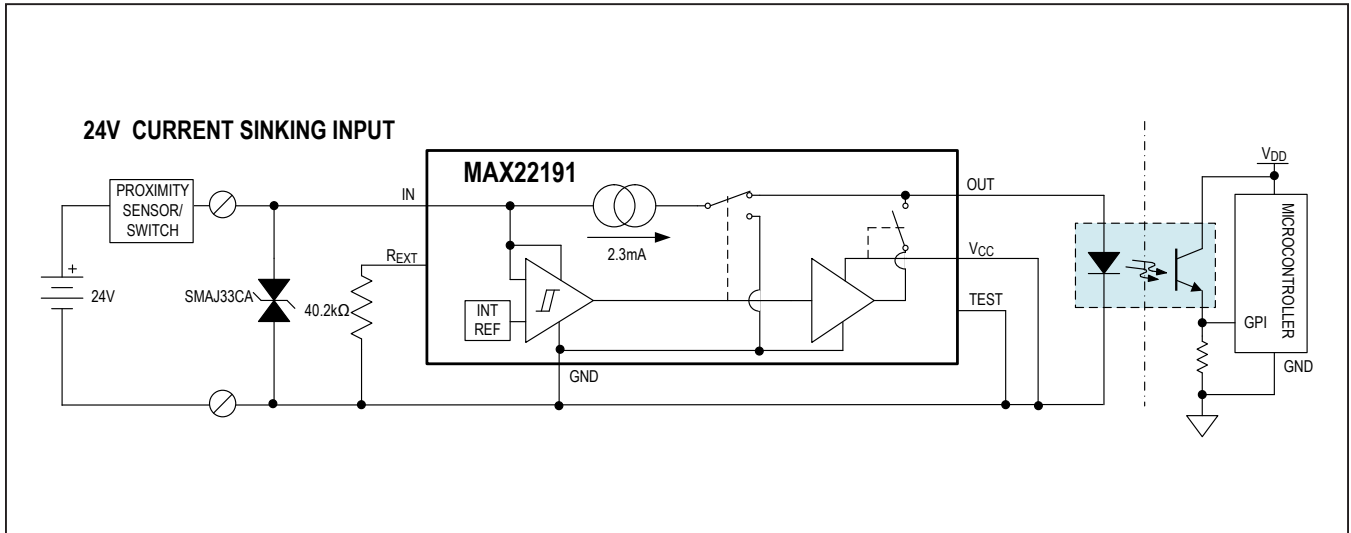
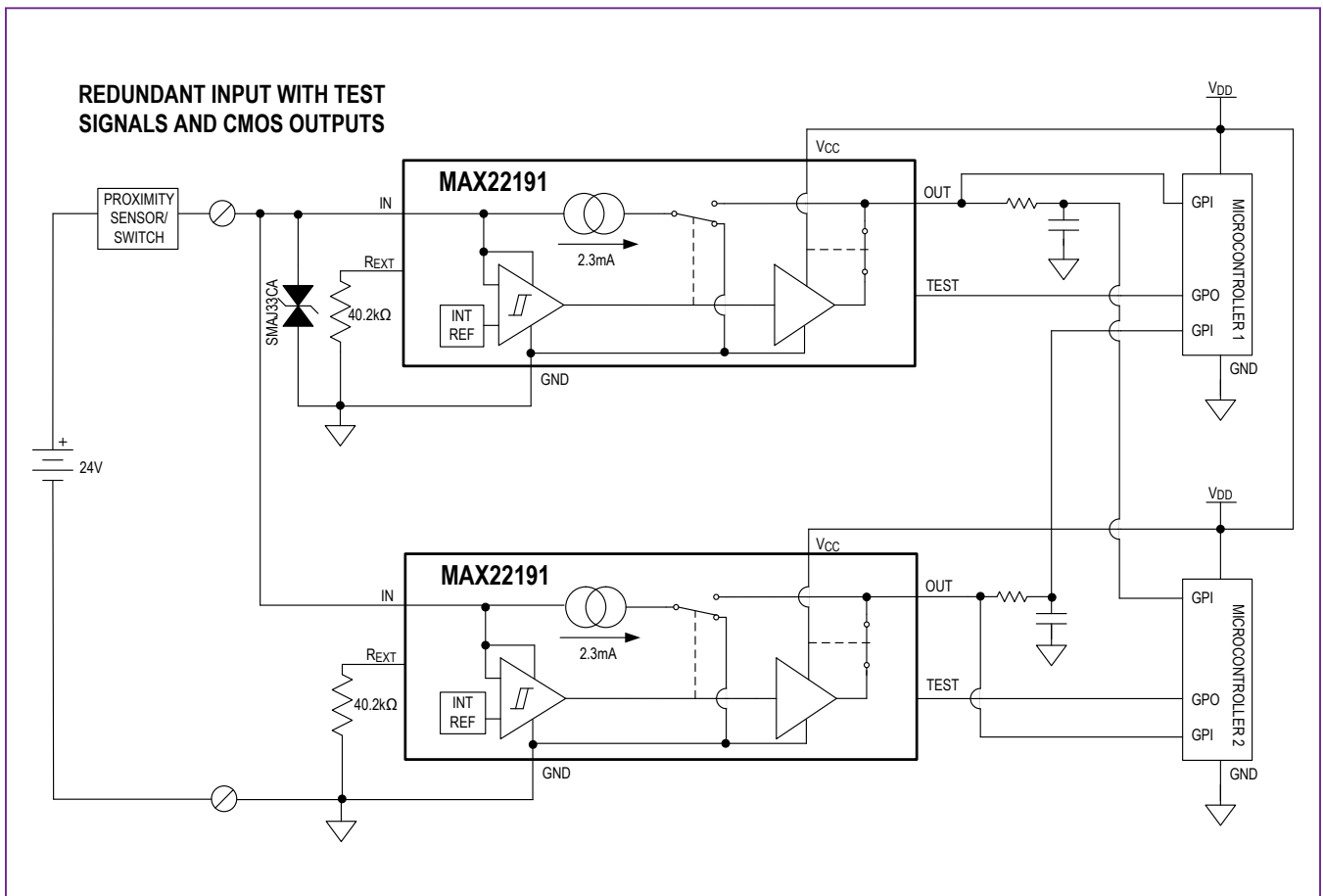
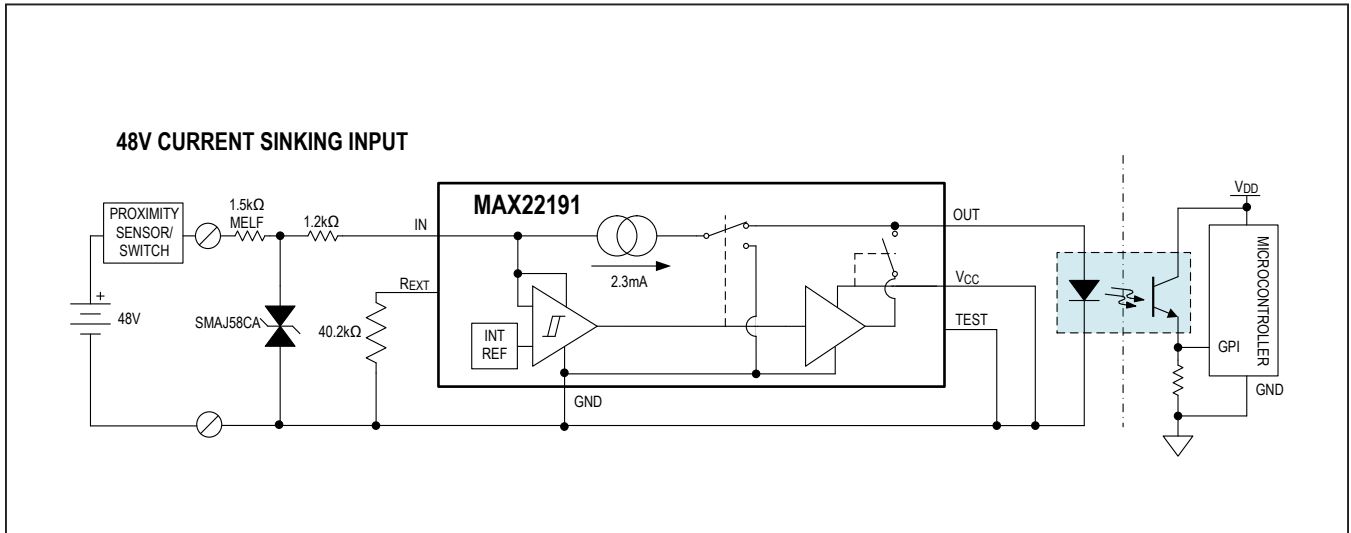

Figure 2. Current Sinking Configuration with Status Indicator LED

Typical Operating Circuits



Typical Operating Circuits (continued)



### Ordering Information

PART	TEMP RANGE	PIN-PACKAGE
MAX22191AUT+	-40°C to +125°C	6 SOT23

+Denotes a lead(Pb)-free/RoHS-compliant package.

T = Tape and reel.

### Chip Information

PROCESS: BICMOS

## Revision History

REVISION NUMBER	REVISION DATE	DESCRIPTION	PAGES CHANGED
0	12/17	Initial release	—
1	10/20	Updated the <i>General Description, Benefits and Features, Simplified Block Diagram, DC Electrical Characteristics, and Typical Operating Circuits</i> sections, and TOC03, TOC07 and TOC08; added new TOC04 and renumbered subsequent TOCs in the Typical Operating Characteristics; added the <i>Connecting a Status/Indicator LED</i> and <i>EMI Protection</i> sections, and new Figure 2	1–2, 5–6 8–9

For pricing, delivery, and ordering information, please visit Maxim Integrated's online storefront at <https://www.maximintegrated.com/en/storefront/storefront.html>.

Maxim Integrated cannot assume responsibility for use of any circuitry other than circuitry entirely embodied in a Maxim Integrated product. No circuit patent licenses are implied. Maxim Integrated reserves the right to change the circuitry and specifications without notice at any time. The parametric values (min and max limits) shown in the Electrical Characteristics table are guaranteed. Other parametric values quoted in this data sheet are provided for guidance.

## X-ON Electronics

Largest Supplier of Electrical and Electronic Components

*Click to view similar products for [Digital Isolators](#) category:*

*Click to view products by [Maxim](#) manufacturer:*

Other Similar products are found below :

[NSI8120N1](#) [NSI8021N1-DSPR](#) [IL3485-3E](#) [IL514E](#) [IL515E](#) [IL611-1E](#) [IL612A-3E](#) [IL710S-1E](#) [IL711-1E](#) [IL711-2E](#) [IL721VE](#) [IL814TE](#)  
[ADN4652BRSZ-RL7](#) [ADUM1441ARSZ](#) [ADUM1447ARSZ](#) [ADUM1447ARSZ-RL7](#) [ADUM230D0BRIZ-RL](#) [ADUM230E1BRIZ-RL](#)  
[ADUM230E0BRIZ-RL](#) [ISO7820DW](#) [ISO7330FCQDWRQ1](#) [ADUM1440ARSZ](#) [ADUM1445ARSZ](#) [ADUM1246ARSZ-RL7](#)  
[ADUM4150ARIZ-RL](#) [ADUM4150BRIZ-RL](#) [LTC4310IMS-1#PBF](#) [IL3522E](#) [IL260E](#) [IL261E](#) [IL3085E](#) [IL3422-3E](#) [IL3585-3E](#) [IL510-1E](#)  
[IL610-1E](#) [IL611-2E](#) [IL613-3E](#) [IL710V-1E](#) [IL712-1E](#) [IL716-1E](#) [ISO7310FCQDRQ1](#) [ISO7342CDWR](#) [ISO7810FDW](#) [ISO7820FDW](#) [IL611-](#)  
[3E](#) [ADN4655BRWZ](#) [ADUM2211SRIZ-RL](#) [ADUM1440ARSZ-RL7](#) [ADUM3473ARSZ](#) [ADUM6210ARSZ](#)