



Click [here](#) to ask an associate for production status of specific part numbers.

Evaluate: MAX22245/MAX22246/ MAX22290/MAX22291

MAX22245/MAX22246/MAX22290/ MAX22291 Evaluation Kits

General Description

The MAX22245/MAX22246/MAX22290/MAX22291 evaluation kits (EV kits) provide a proven design to evaluate the MAX22245, MAX22246, MAX22290 and MAX22291, reinforced, two-channel, galvanic digital isolators. Three types of evaluation boards are available to support this family of isolators. The MAX22246CWEVKIT# is fully assembled and tested and comes populated with the MAX22246CAWA+ ([Figure 1](#)). The MAX2224XWEVKIT# is a generic board which has unpopulated wide SOIC footprint as U1, allowing the user to install any MAX22245/MAX22246 variant ([Figure 2](#)). The MAX2229XSEVKIT# is a generic board which has unpopulated narrow SOIC footprint as U1, allowing the user to install any MAX22290/MAX22291 variant ([Figure 3](#)). Among the three evaluation boards, devices with either wide-body 8-pin SOIC package or narrow-body 8-pin SOIC package are supported. See [Table 1](#) for EV kit options.

The EV kits should be powered from two independent isolated power supplies with nominal output voltage in range from 1.71V to 5.5V. For evaluating the electrical parameters of the device without any isolation between the two sides, a single power supply can also be used.

The MAX2224XWEVKIT# comes with U1 unpopulated and supports the following digital isolators: MAX22245BAWA+, MAX22245CAWA+, MAX22245EAWA+, MAX22245FAWA+, MAX22246BAWA+, MAX22246CAWA+, MAX22246EAWA+, MAX22246FAWA+, MAX22245BAWA/V+, MAX22245CAWA/V+, MAX22245EAWA/V+, MAX22245FAWA/V+, MAX22246BAWA/V+, MAX22246CAWA/V+, MAX22246EAWA/V+, MAX22246FAWA/V+.

The MAX2229XSEVKIT# comes with U1 unpopulated and supports the following digital isolators: MAX22290BASA+, MAX22290CASA+, MAX22290EASA+, MAX22290FASA+.

MAX22291BASA+, MAX22291CASA+, MAX22291EASA+, MAX22291FASA+, MAX22290BASA/V+, MAX22290CASA/V+, MAX22290EASA/V+, MAX22290FASA/V+, MAX22291BASA/V+, MAX22291CASA/V+, MAX22291EASA/V+, MAX22291FASA/V+.

Note: When ordering the MAX2224XW EV kit, request a sample of the desired MAX22245 or MAX22246 isolator IC that can be soldered to the PCB. When ordering the MAX2229XS EV kit, request a sample of the desired MAX22290 or MAX22291 isolator IC that can be soldered to the PCB.

Features

- Broad Range of Data Transfer Rates (from DC to 200Mbps)
- MAX22245 and MAX22290 with 2:0 Channel Configuration, MAX22246 and MAX22291 with 1:1 Channel Configuration
- Support Both Narrow SOIC Package and Wide SOIC Package
- SMA Connectors for Easy Connection to External Equipment
- Wide Power Supply Voltage Range from 1.71V to 5.5V
- Guaranteed up to 5kV_{RMS} Isolation for 60s (MAX2224XW)
- Guaranteed up to 3kV_{RMS} Isolation for 60s (MAX2229XS)
- -40°C to +125°C Temperature Range
- Proven PCB Layout

[Ordering Information](#) appears at end of data sheet.

Table 1. EV Kit Options

EV KIT PART NUMBER	TARGET DEVICE	PACKAGE TYPE	COMMENT
MAX22246CWEVKIT#	MAX22246CAWA+	8-SOIC Wide Body	200Mbps IC Populated
MAX2224XWEVKIT#	Not populated	8-SOIC Wide Body	Request Samples of Target Device from Maxim
MAX2229XSEVKIT#	Not populated	8-SOIC Narrow Body	Request Samples of Target Device from Maxim

319-100536; Rev 1; 8/21

**MAX22245/MAX22246/
MAX22290/MAX22291
Evaluation Kits**

Evaluate: MAX22245/MAX22246/
MAX22290/MAX22291

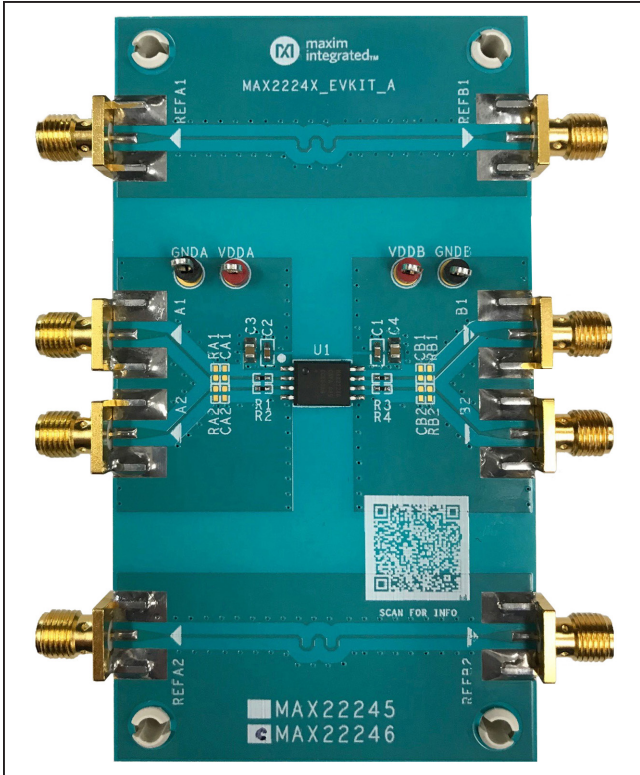

Figure 1. MAX22246CW EV Kit



Figure 2. MAX2224XW EV Kit

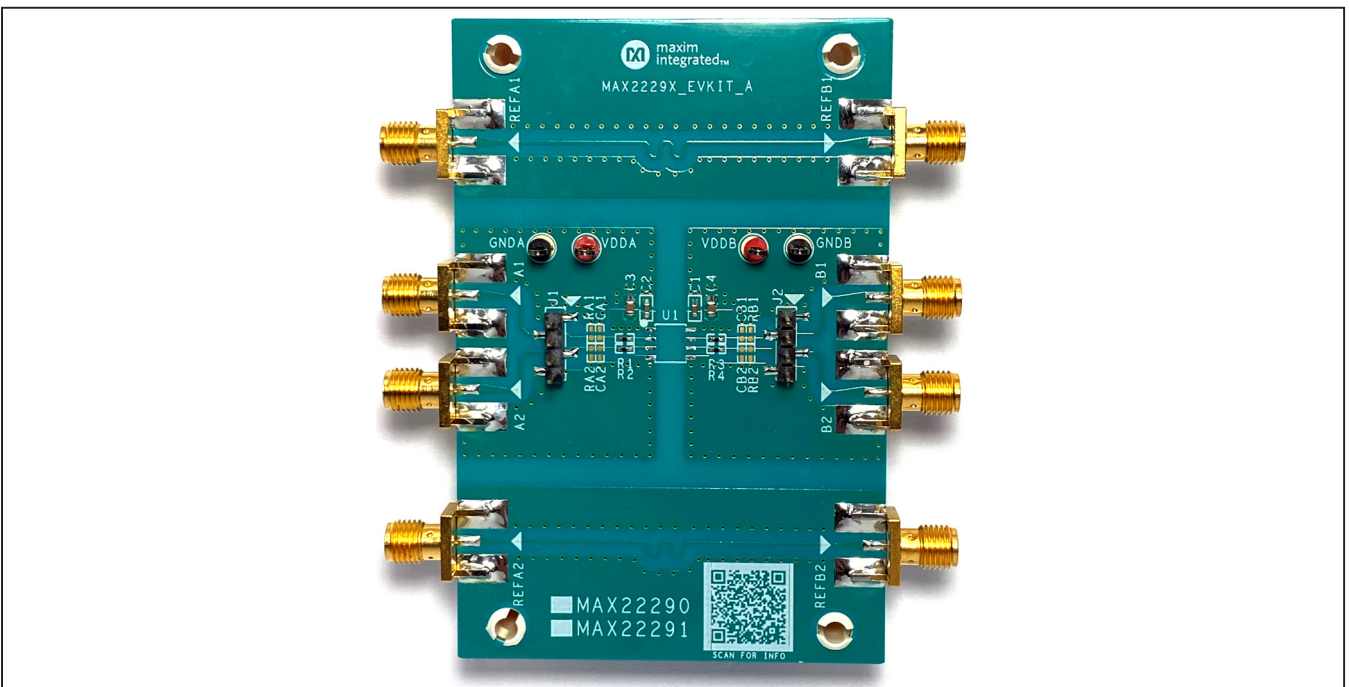

Figure 3. MAX2229XS EV Kit

MAX22245/MAX22246/ MAX22290/MAX22291 Evaluation Kits

Evaluate: MAX22245/MAX22246/ MAX22290/MAX22291

Quick Start

Required Equipment

- MAX22246CW, MAX2224XW or MAX2229XS EV kit
- MAX22245 or MAX22246 device, if using MAX222XW EV kit
- MAX22290 or MAX22291 device, if using MAX2229XS EV kit
- Two DC power supplies with output range of 1.71V to 5.5V
- Signal/function generator
- Oscilloscope

Procedure

The MAX22246CW EV kit is fully assembled and ready for evaluation. The MAX2224XW and MAX2229XS EV kits have everything except the DUT (U1) installed. The user can install the desired version of the MAX22245/MAX22246/MAX22290/MAX22291 family of reinforced,

two-channel, unidirectional digital isolators. Once installed, use the following steps to verify board functionality:

- 1) Connect one DC power supply between the EV kit's VDDA and GNDA test points; connect the other DC power supply between VDDDB and GNDB test points.
- 2) Set both DC power supply outputs between 1.71V and 5.5V, and then enable the power supply output.

Note: It is also possible to power the EV kit from a single power supply to test electrical parameters but this invalidates the digital isolation of the IC.

- 3) Connect the signal/function generator to an input SMA connector of side A and observe the isolated signal on the corresponding side B output, using an oscilloscope. On the MAX22246CW EV kit, SMA connectors A2 and B1 are inputs, and SMA connectors A1 and B2 are outputs. See [Table 2](#) for the SMA connector I/O configurations when either a MAX22245 or a MAX22246 device is installed as U1 on the MAX2224XW EV kit, or either a MAX22290 or a MAX22291 device is installed as U1 on the MAX2229XS EV kit.

Table 2. MAX2224XW and MAX2229XS EV Kit Connector Configurations

CONNECTOR	U1 DEVICE	
	MAX22245, MAX22290	MAX22246, MAX22291
SIDE A		
VDDA	VDDA test point	VDDA test point
GNDA	GNDA test point	GNDA test point
A1	SMA connector for IN1	SMA connector for OUT1
A2	SMA connector for IN2	SMA connector for IN2
REFA1	I/O on side A	I/O on side A
REFA2	I/O on side A	I/O on side A
SIDE B		
VDDDB	VDDDB test point	VDDDB test point
GNDB	GNDB test point	GNDB test point
B1	SMA connector for OUT1	SMA connector for IN1
B2	SMA connector for OUT2	SMA connector for OUT2
REFB1	I/O on side B	I/O on side B
REFB2	I/O on side B	I/O on side B

MAX22245/MAX22246/ MAX22290/MAX22291 Evaluation Kits

Evaluate: MAX22245/MAX22246/ MAX22290/MAX22291

Detailed Description of Hardware

The MAX22246CW, MAX222XW, and MAX2229XS EV kits allow the user to evaluate the features of the MAX22245/MAX22246/MAX22290/MAX22291 two-channel digital isolators.

External Power Supplies

Power to the MAX22246CW, MAX222XW, and MAX2229XS EV kits is derived from two external sources which can both be between +1.71V and +5.5V. Connect one source between the VDDA and GNDA test points, and the other source between the VDDB and GNDB test points. Each supply can be set independently and can be present over the entire range from +1.71V to +5.5V, regardless of the level or presence of the other supply. The MAX22245/MAX22246/MAX22290/MAX22291 level-shift the data, transmitting them across the isolation barrier.

Two SMA connectors on each side of the board allow easy connections to signal generator(s) and oscilloscope. A typical test setup is shown in [Figure 4](#).

Decoupling Capacitors

Each power supply is decoupled with a 1 μ F ceramic capacitor in parallel with a 0.1 μ F ceramic capacitor, which are placed close to U1 VDDA and VDDB pins.

I/O Traces Impedance Control

The input and output traces of both isolation channels have an impedance control of 50 Ω . A 20 Ω series resistor is added to both input and output channels; along with the internal series resistance, it can provide 50 Ω impedance matching with external equipment such as function generators or oscilloscopes.

Output Load

Each output has an unpopulated 0402 SMT resistor (RA1, RA2, RB1, and RB2) and an unpopulated 0402 SMT capacitor (CA1, CA2, CB1, and CB2) to GND_ to allow different loads based on customer requirements.

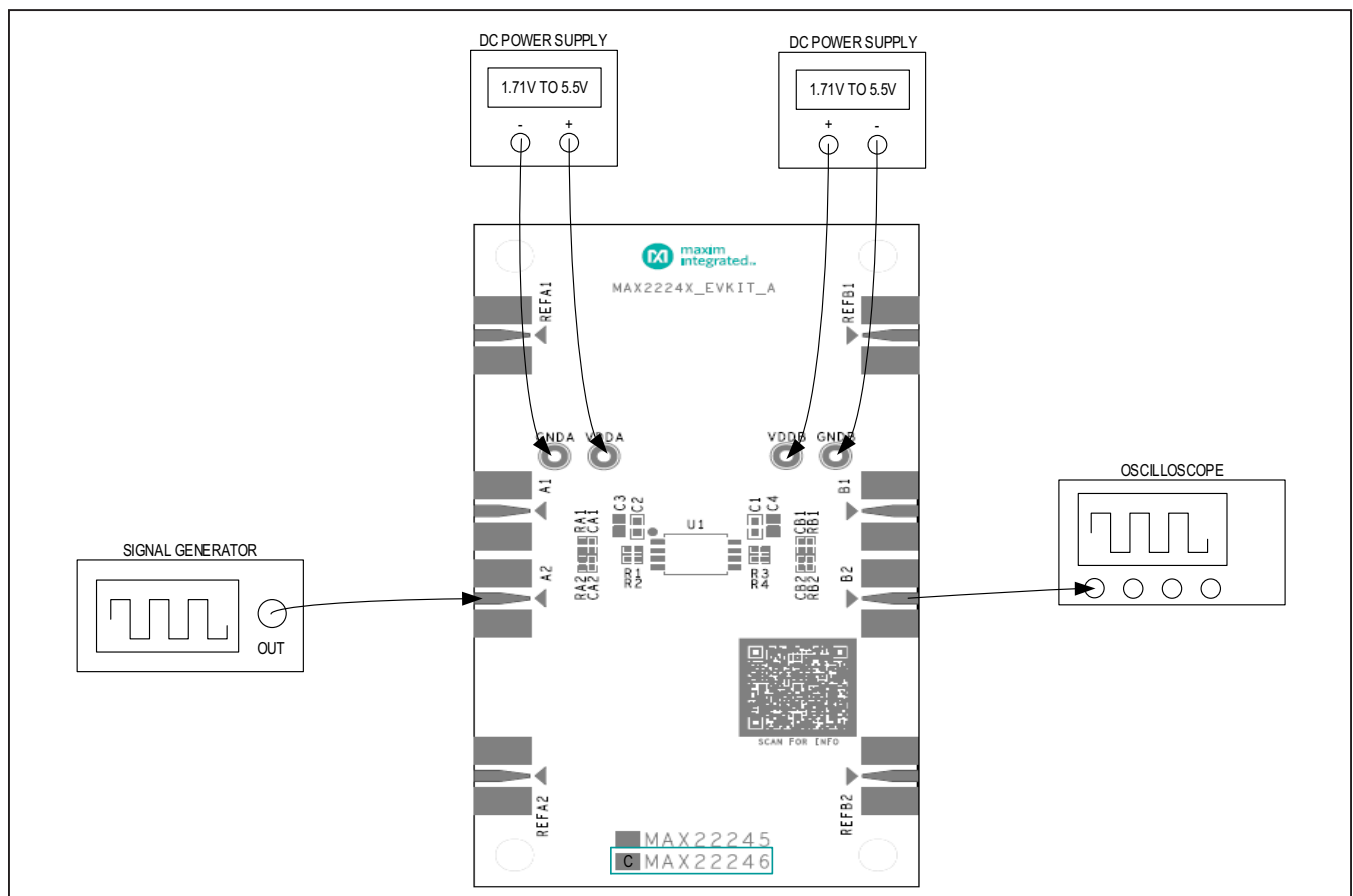

Figure 4. MAX2224XW EV Kit Typical Test Setup

MAX22245/MAX22246/ MAX22290/MAX22291 Evaluation Kits

Calibration Channels

Two reference channels (REFA1-REFB1 and REFA2-REFB2) are implemented on the EV kits to help calibrate the test setup for timing measurements such as propagation delay. Measure the propagation delay (t_{PD_REF}) using the reference channel first to determine the delay introduced by the test setup. Measure the propagation delay (t_{PD_ISO}) again using one of the MAX22245/MAX22246/MAX22290/MAX22291 data channels. The calibrated isolator delay is $t_{PD_ISO} - t_{PD_REF}$.

U1 on the MAX2224XW and MAX2229XS EV Kits

U1 on the MAX2224XWEVKIT# and MAX2229XSEVKIT# is not installed. The user can install the desired version of the MAX22245/MAX22246 on the MAX2224XW EV kit, and install the desired version of the MAX22290/MAX22291 on the MAX2229XS EV kit. The MAX22245/

Evaluate: MAX22245/MAX22246/ MAX22290/MAX22291

MAX22246/MAX22290/MAX22291 family offers two uni-directional channel configurations. The MAX22245 and MAX22290 feature both channels transferring digital signals in one direction. SMA connectors A1 and A2 on side A are input connectors, and B1 and B2 on side B are output connectors if the MAX22245 or MAX22290 is installed as U1. The MAX22246 and MAX22291 have one channel transmitting data in one direction and the other channel transmitting in the opposite direction. SMA connectors A2 and B1 are input connectors, and A1 and B2 are output connectors if the MAX22246 or MAX22291 is installed as U1. See [Table 2](#) for SMA connector I/O configurations with different U1 selection.

When installing U1, make sure pin 1 of the device is mounted onto pin 1 of U1 on the PCB. Pin 1 is located at the upper left corner of U1, denoted by a white dot on the silkscreen.

Ordering Information

PART	TYPE
MAX22246CWEVKIT#	EV Kit with installed MAX22246CAWA+
MAX2224XWEVKIT#	EV Kit for Wide Body SOIC Package
MAX2229XSEVKIT#	EV Kit for Narrow Body SOIC Package

#Denotes RoHS compliance.

**MAX22245/MAX22246/
MAX22290/MAX22291
Evaluation Kits**

Evaluate: MAX22245/MAX22246/
MAX22290/MAX22291

MAX22245/MAX22246 EV Kit Bill of Materials

ITEM	REF_DES	DNI/DNP	QTY	MFG PART #	MANUFACTURER	VALUE	DESCRIPTION
1	A1, A2, B1, B2, REFA1, REFA2, REFB1, REFB2	—	8	142-0701-851	JOHNSON COMPONENTS	142-0701-851	CONNECTOR; END LAUNCH JACK RECEPTACLE; BOARDMOUNT; STRAIGHT THROUGH; 2PINS;
2	C1, C2	—	2	CC0603KRX7R0BB104; GRM188R72A104KA35; GCJ188R72A104KA01; HMK107B7104KA; 06031C104KAT2A; GRM188R72A104K	YAGEO;MURATA; MURATA; TAIYO YUDEN; AVX;MURATA	0.1 μ F	CAPACITOR; SMT (0603); CERAMIC CHIP; 0.1 μ F; 100V; TOL = 10%; TG = -55°C TO +125°C; TC = X7R
3	C3, C4	—	2	GRM21BR71H105KA12; CL21B105KBFNNN; C2012X7R1H105K085AC; UMK212B7105KG; CGA4J3X7R1H105K125AB	MURATA; SAMSUNG ELECTRONICS; TDK;TAIY	1 μ F	CAPACITOR; SMT (0805); CERAMIC CHIP; 1UF; 50V; TOL = 10%; TG = -55°C TO +125°C; TC = X7R
4	GND A, GND B	—	2	5011	KEYSTONE	N/A	TEST POINT; PIN DIA = 0.125IN; TOTAL LENGTH = 0.445IN; BOARD HOLE = 0.063IN; BLACK; PHOSPHOR BRONZE WIRE SILVER PLATE FINISH;
5	MTH1-MTH4	—	4	9032	KEYSTONE	9032	MACHINE FABRICATED; ROUND-THRU HOLE SPACER; NO THREAD; M3.5; 5/8IN; NYLON
6	R1-R4	—	4	CRCW040220R0FK	VISHAY DALE	20	RESISTOR; 0402; 20 Ω ; 1%; 100PPM; 0.063W; THICK FILM
7	U1	—	1	MAX2224X	MAXIM	MAX2224X	EVKIT PART - IC; MAX2224X SERIES; COMBINED SCHEMATIC SYMBOL FOR MAX22245 AND MAX22246; PACKAGE LAND PATTERN: 90-100146; WSOIC8
8	VDDA, VDD B	—	2	5010	KEYSTONE	N/A	TEST POINT; PIN DIA=0.125IN; TOTAL LENGTH = 0.445IN; BOARD HOLE=0.063IN; RED; PHOSPHOR BRONZE WIRE SIL;
9	PCB	—	1	MAX	MAXIM	PCB	PCB:MAX
10	CA1, CA2, CB1, CB2	DNP	0	N/A	N/A	OPEN	PACKAGE OUTLINE 0402 NON-POLAR CAPACITOR
11	RA1, RA2, RB1, RB2	DNP	0	N/A	N/A	OPEN	PACKAGE OUTLINE 0402 RESISTOR
TOTAL			26				

**MAX22245/MAX22246/
MAX22290/MAX22291
Evaluation Kits**

Evaluate: MAX22245/MAX22246/
MAX22290/MAX22291

MAX22245/MAX22246 EV Kit Schematic

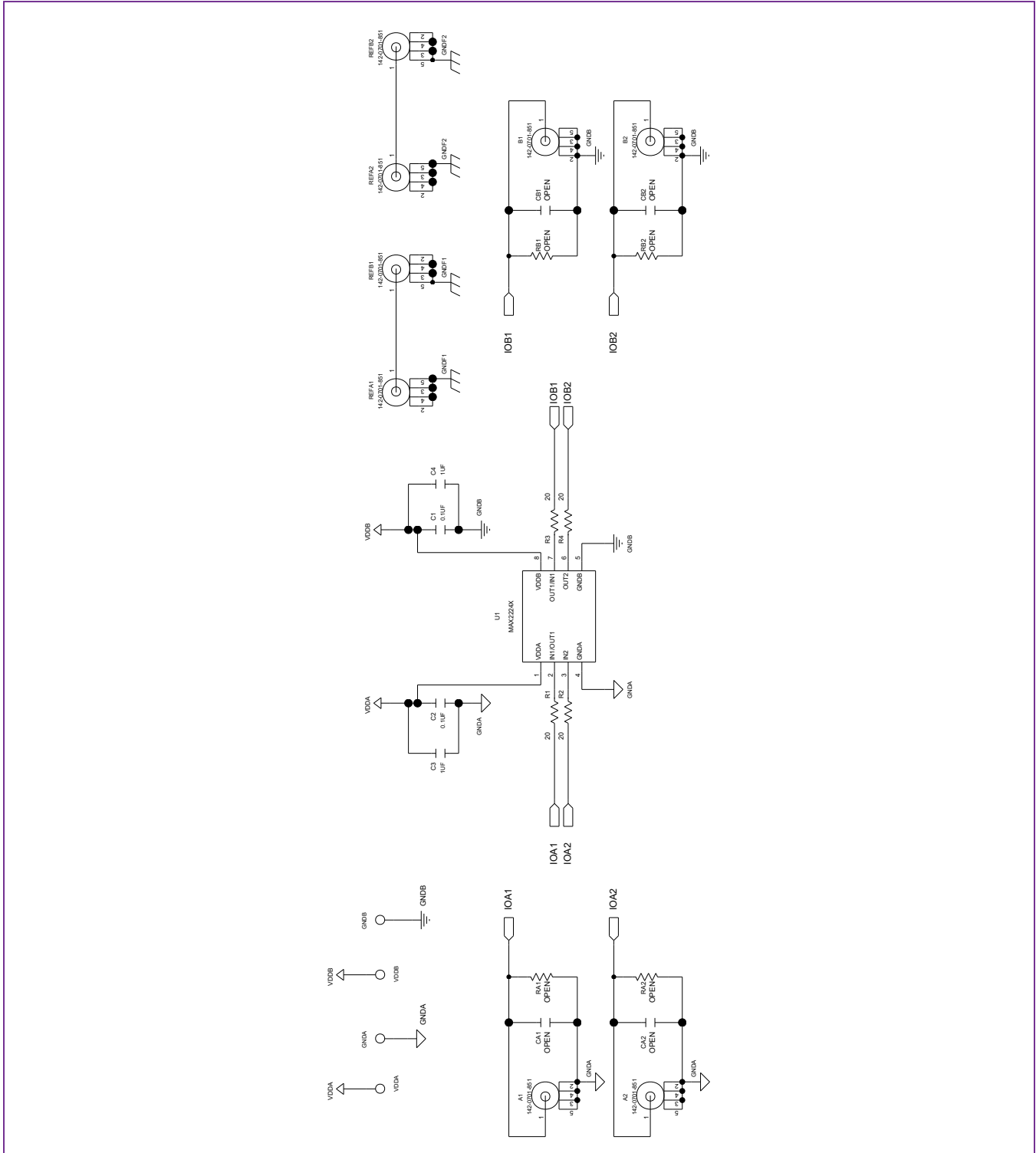

**MAX22245/MAX22246/
MAX22290/MAX22291
Evaluation Kits**

Evaluate: MAX22245/MAX22246/
MAX22290/MAX22291

MAX22245/MAX22246 EV Kit PCB Layout Diagrams

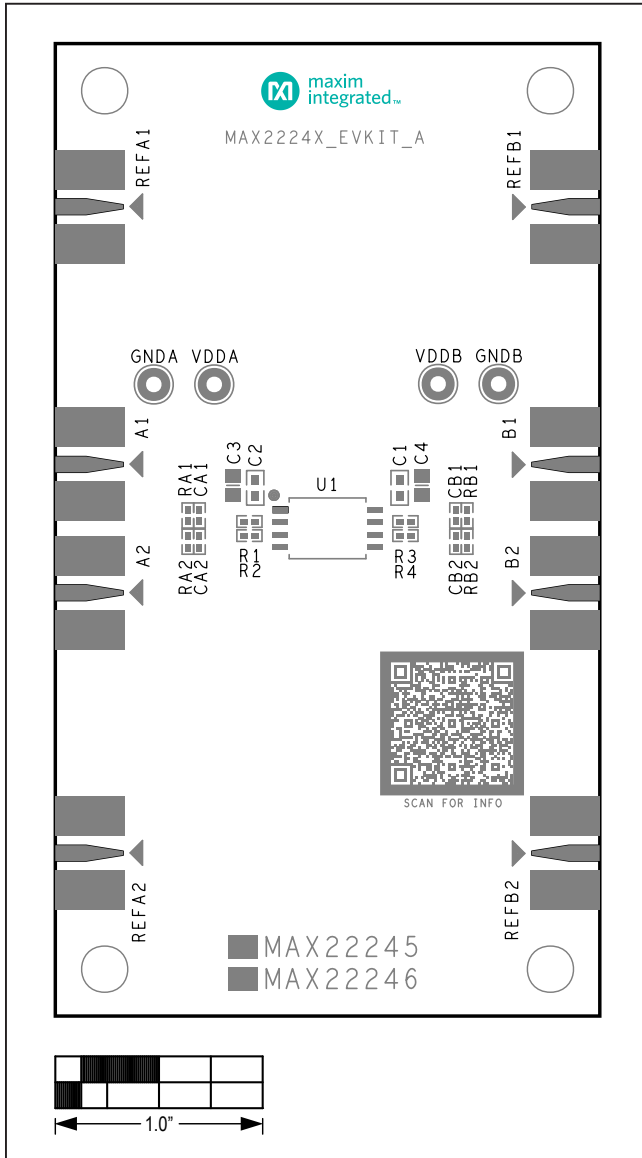

MAX22245/MAX22246 EV Kit—Top Silkscreen

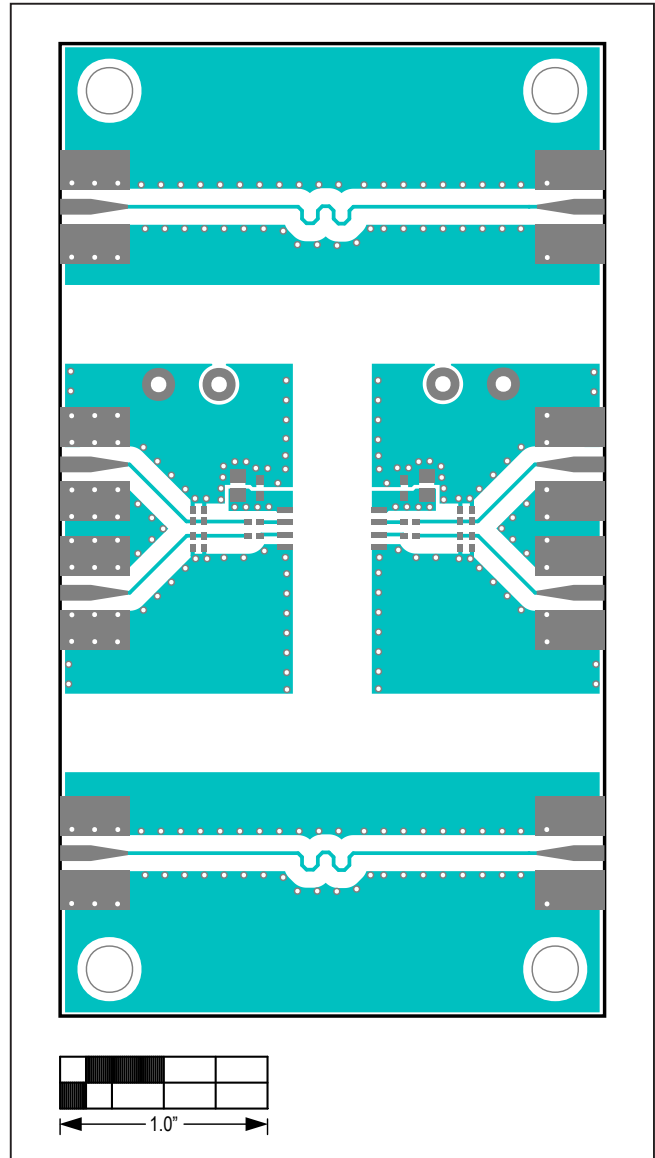

MAX22245/MAX22246 EV Kit—Top

**MAX22245/MAX22246/
MAX22290/MAX22291
Evaluation Kits**

Evaluate: MAX22245/MAX22246/
MAX22290/MAX22291

MAX22245/MAX22246 EV Kit PCB Layout Diagrams (continued)

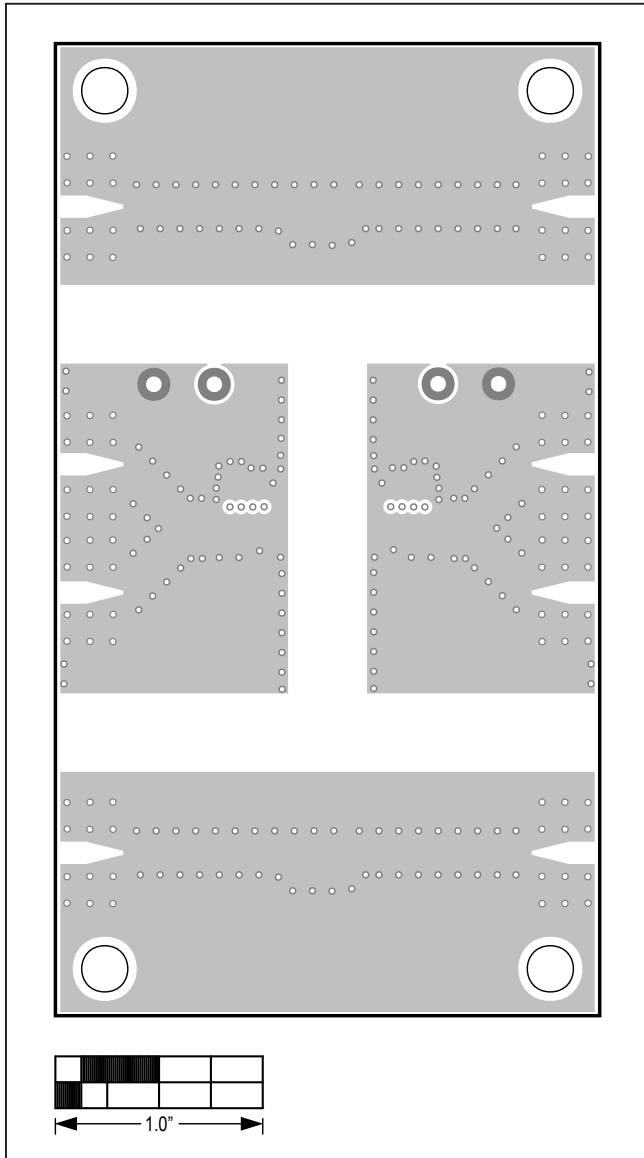

MAX22245/MAX22246 EV Kit—Layer 2 GND

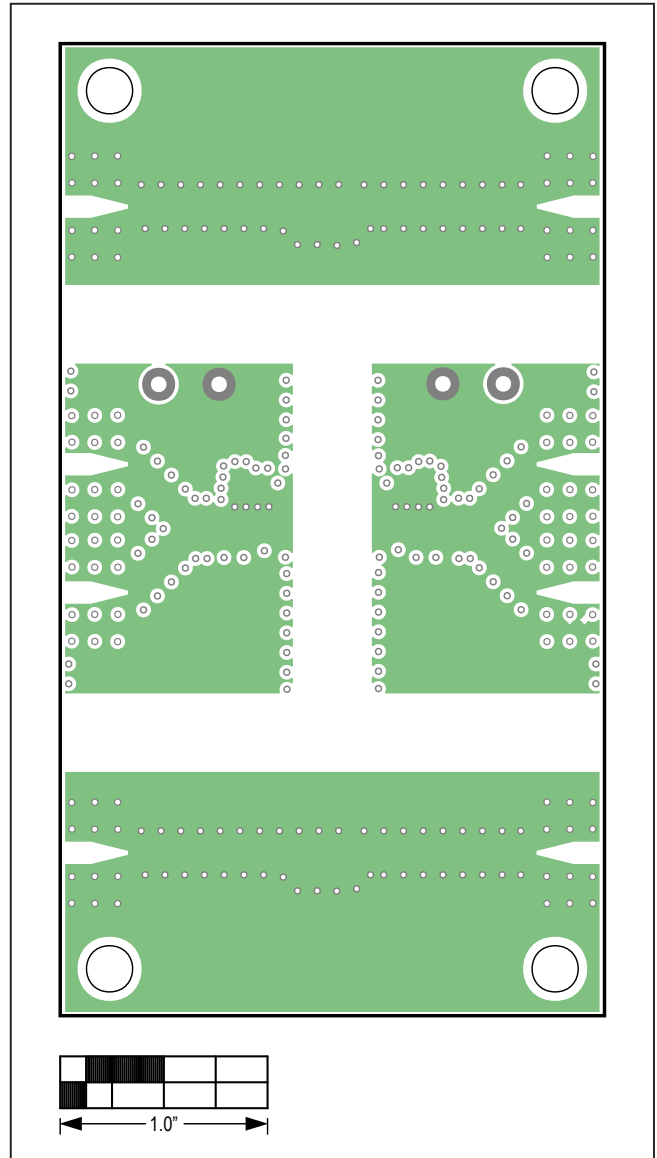

MAX22245/MAX22246 EV Kit—Layer 3 PWR

**MAX22245/MAX22246/
MAX22290/MAX22291
Evaluation Kits**

Evaluate: MAX22245/MAX22246/
MAX22290/MAX22291

MAX22245/MAX22246 EV Kit PCB Layout Diagrams (continued)

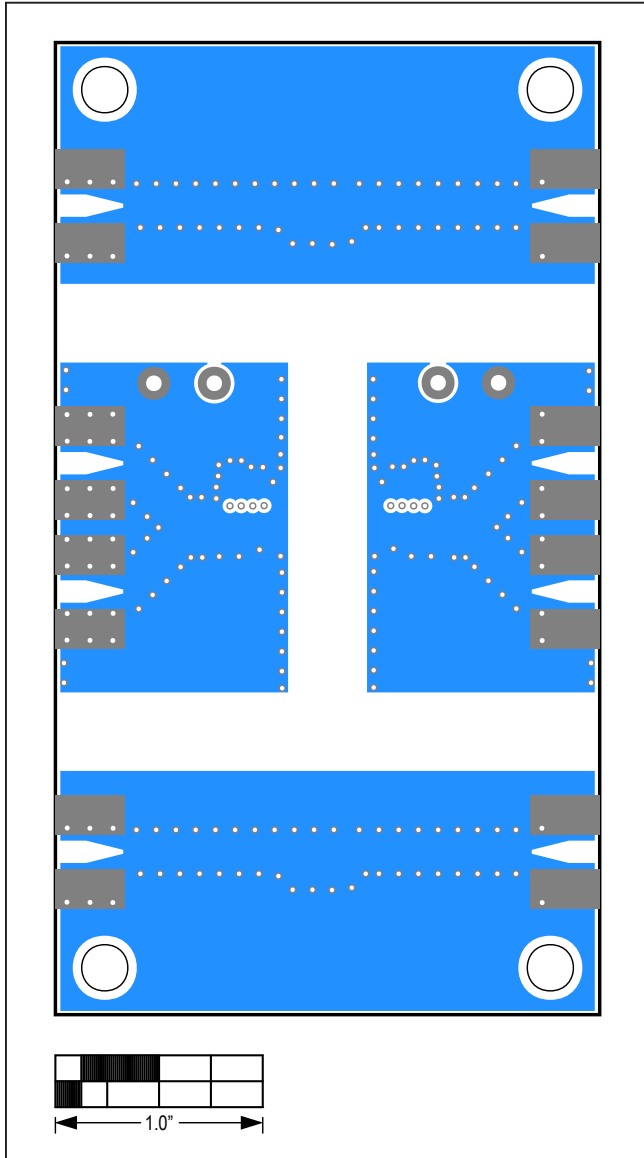

MAX22245/MAX22246 EV Kit—Bottom

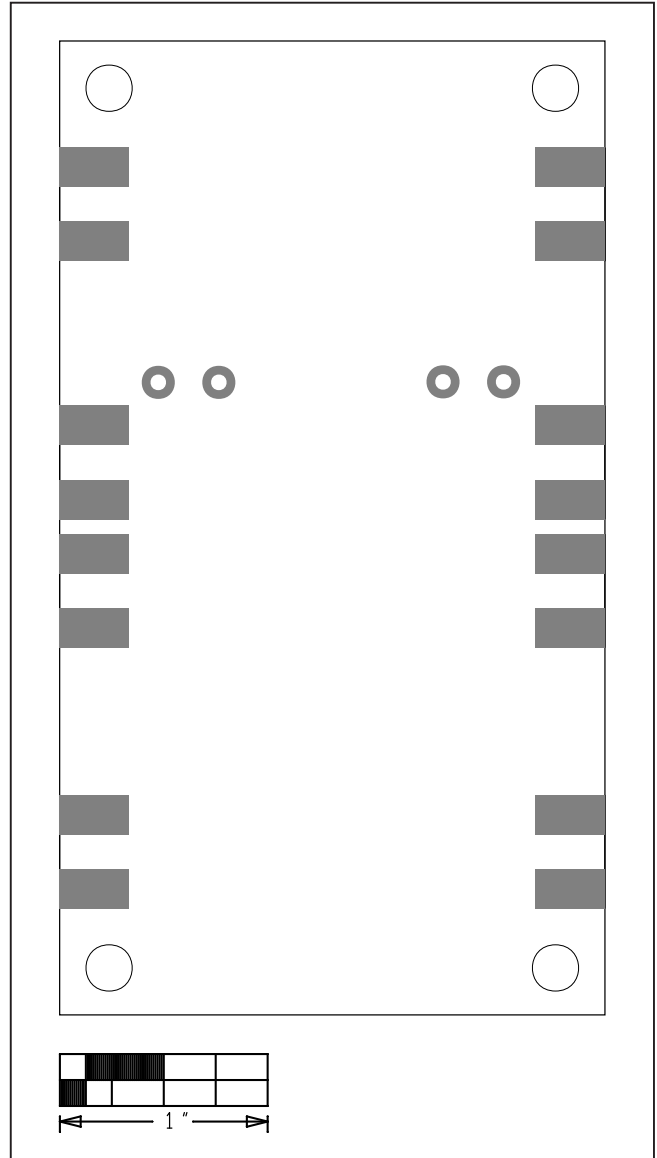

MAX22245/MAX22246 EV Kit—Bottom Silkscreen

**MAX22245/MAX22246/
MAX22290/MAX22291
Evaluation Kits**

Evaluate: MAX22245/MAX22246/
MAX22290/MAX22291

MAX22290/MAX22291 EV Kit Bill of Materials

ITEM	REF_DES	DNI/DNP	QTY	MFG PART #	MANUFACTURER	VALUE	DESCRIPTION	COMMENTS
1	A1, A2, B1, B2, REFA1, REFA2, REFB1, REFB2	-	8	142-0701-851	JOHNSON COMPONENTS	142-0701-851	CONNECTOR; END LAUNCH JACK RECEPTACLE; BOARDMOUNT; STRAIGHT THROUGH; 2PINS;	
2	C1, C2	-	2	CC0603KRX7R0BB104; GRM188R72A104KA35; HMK107B7104KA; 06031C104KAT2A; GRM188R72A104K	YAGEO;MURATA;TAIYO YUDEN;AVX;MURATA	0.1UF	CAP; SMT (0603); 0.1UF; 10%; 100V; X7R; CERAMIC	
3	C3, C4	-	2	GRM21BR71H105KA12; CL21B105KBFNNN; C2012X7R1H105K085AC; UMK212B7105KG	MURATA;SAMSUNG ELECTRONICS;TDK	1UF	CAP; SMT (0805); 1UF; 10%; 50V; X7R; CERAMIC	
4	GNDA, GNDB	-	2	5011	KEYSTONE	N/A	TEST POINT; PIN DIA=0.125IN; TOTAL LENGTH=0.445IN; BOARD HOLE=0.063IN; BLACK; PHOSPHOR BRONZE WIRE SILVER PLATE FINISH;	
5	J1, J2	-	2	5-146128-2	TE CONNECTIVITY	5-146128-2	CONNECTOR; HEADER ASSEMBLY; BREAKAWAY MALE; SMT; STRAIGHT; 4PINS	
6	MTH1-MTH4	-	4	9032	KEYSTONE	9032	MACHINE FABRICATED; ROUND-THRU HOLE SPACER; NO THREAD; M3.5; 5/8IN; NYLON	
7	R1-R4	-	4	CRCW040220R0FK	VISHAY DALE	20	RES; SMT (0402); 20; 1%; +/-100PPM/DEGC; 0.0630W	
8	VDDA, VDDDB	-	2	5010	KEYSTONE	N/A	TEST POINT; PIN DIA=0.125IN; TOTAL LENGTH=0.445IN; BOARD HOLE=0.063IN; RED; PHOSPHOR BRONZE WIRE SIL;	
9	PCB	-	1	MAX2229X	MAXIM	PCB	PCB:MAX2229X	-
10	U1	DNP	0	MAX22290/MAX22291	MAXIM	MAX22290/MAX22291	EVKIT PART - IC; REINFORCED; FAST; LOW-POWER; TWO CHANNEL DIGITAL ISOLATOR;	
11	CA1, CA2, CB1, CB2	DNP	0	N/A	N/A	OPEN	PACKAGE OUTLINE 0402 NON-POLAR CAPACITOR	
12	RA1, RA2, RB1, RB2	DNP	0	N/A	N/A	OPEN	PACKAGE OUTLINE 0402 RESISTOR	
TOTAL			27					

**MAX22245/MAX22246/
MAX22290/MAX22291
Evaluation Kits**

Evaluate: MAX22245/MAX22246/
MAX22290/MAX22291

MAX22290/MAX22291 EV Kit PCB Layout Diagrams

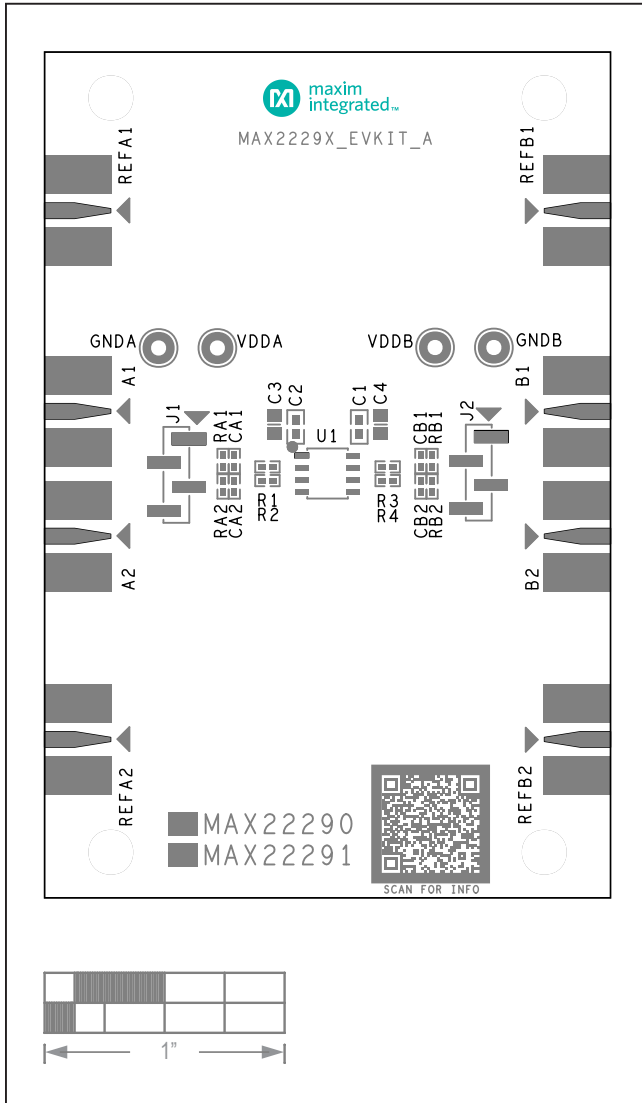

MAX22290/MAX22291 EV Kit—Top Silkscreen

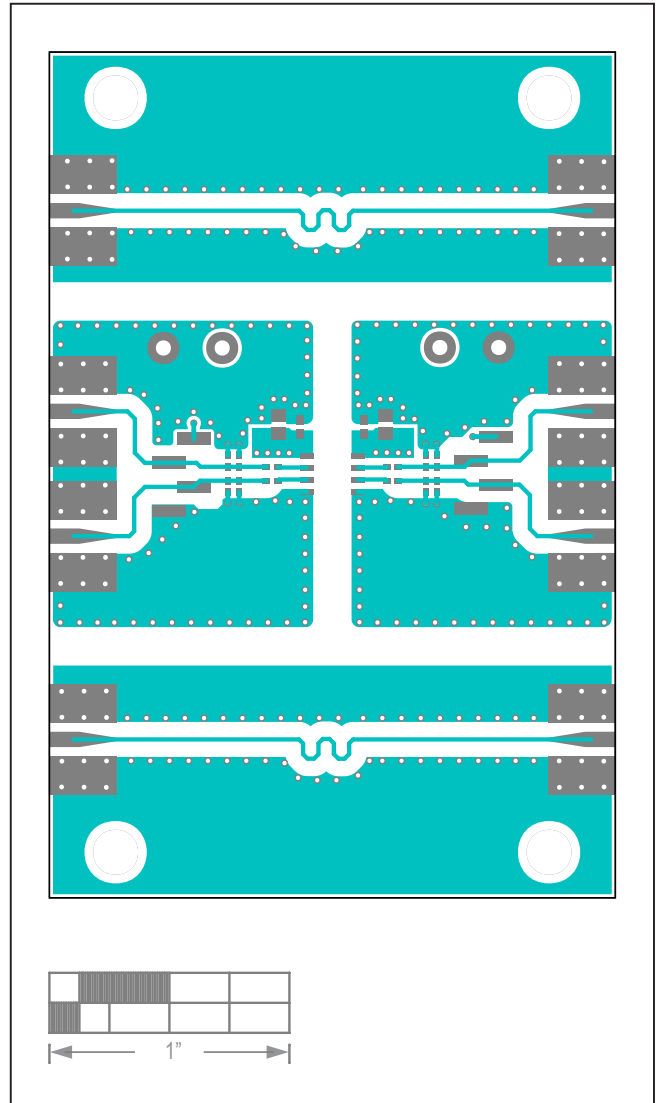

MAX22290/MAX22291 EV Kit—Top

**MAX22245/MAX22246/
MAX22290/MAX22291
Evaluation Kits**

Evaluate: MAX22245/MAX22246/
MAX22290/MAX22291

MAX22290/MAX22291 EV Kit PCB Layout Diagrams (continued)

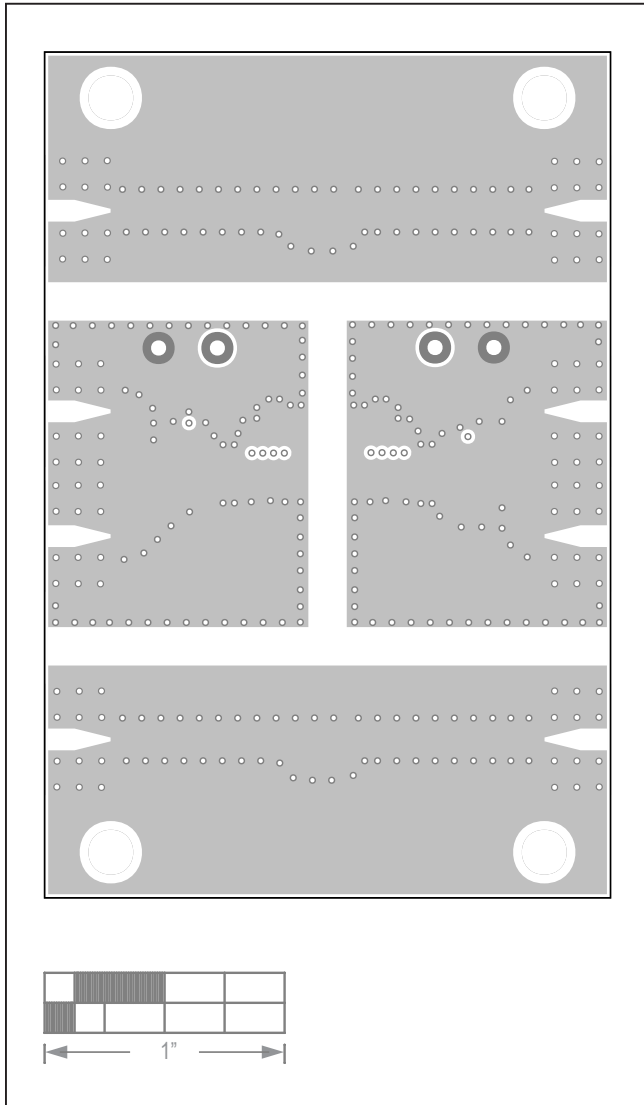

MAX22290/MAX22291 EV Kit—Layer 2 GND

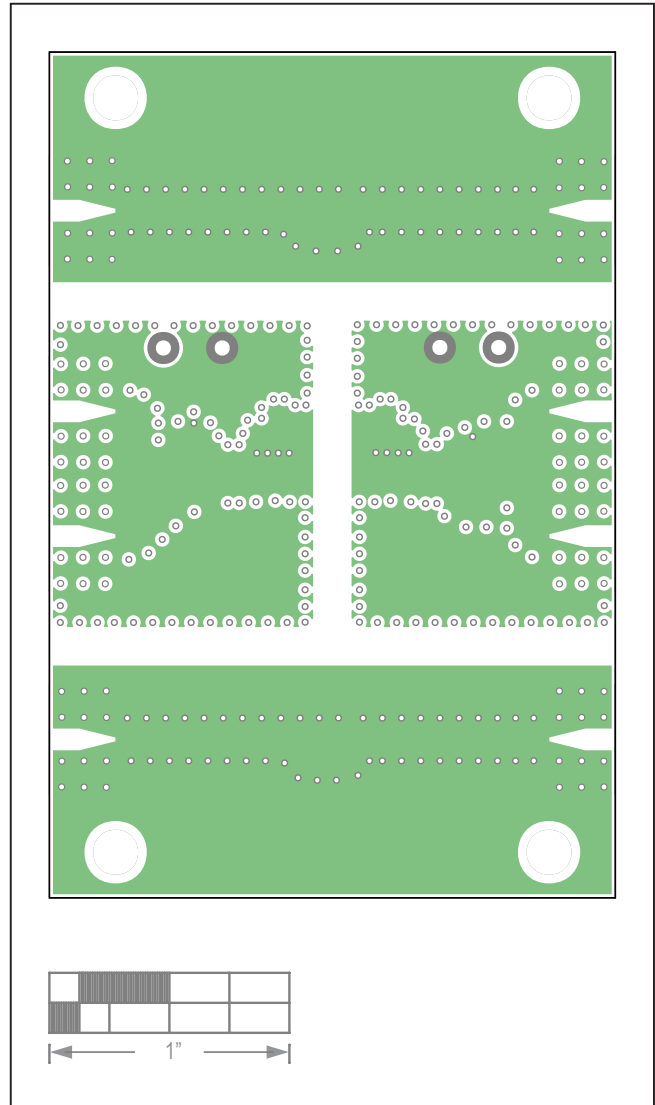

MAX22290/MAX22291 EV Kit—Layer 3 PWR

MAX22290/MAX22291 EV Kit PCB Layout Diagrams (continued)

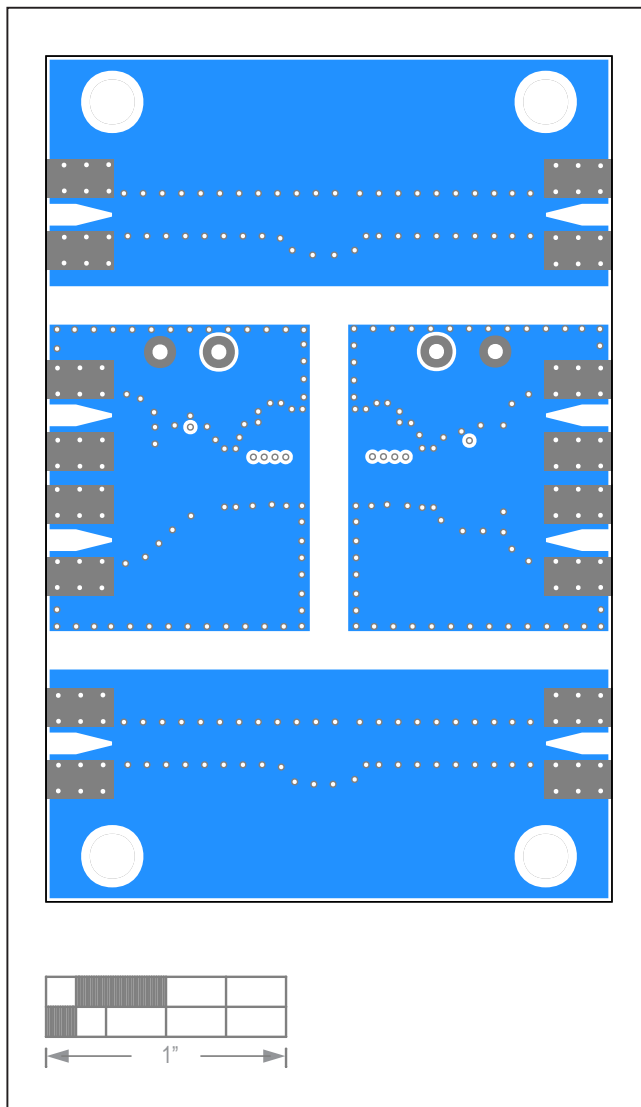

MAX22290/MAX22291 EV Kit—Bottom

**MAX22245/MAX22246/
MAX22290/MAX22291
Evaluation Kits**

Evaluate: MAX22245/MAX22246/
MAX22290/MAX22291

Revision History

REVISION NUMBER	REVISION DATE	DESCRIPTION	PAGES CHANGED
0	5/20	Initial Release	—
1	8/21	Updated <i>General Description, Benefits and Features, Table 1, Quick Start</i> section, <i>Table 2, Detailed Description, External Power Supplies</i> section, <i>Calibration Channels</i> section, and <i>Ordering Information</i> table; Added Figure 3, <i>U1 on the MAX2224XW and MAX2229XS EV Kits</i> section, and MAX22290/1 EV Kit Bill of Materials, Schematic, and PCB Layout Diagrams	1–5, 11–15



Information furnished by Analog Devices is believed to be accurate and reliable. However, no responsibility is assumed by Analog Devices for its use, nor for any infringements of patents or other rights of third parties that may result from its use. Specifications subject to change without notice. No license is granted by implication or otherwise under any patent or patent rights of Analog Devices. Trademarks and registered trademarks are the property of their respective owners.

X-ON Electronics

Largest Supplier of Electrical and Electronic Components

Click to view similar products for [Interface Development Tools](#) category:

Click to view products by [Maxim](#) manufacturer:

Other Similar products are found below :

[ADP5585CP-EVALZ](#) [CHA2066-99F](#) [AS8650-DB](#) [MLX80104 TESTINTERFACE](#) [416100120-3](#) [XR18910ILEVB](#) [XR21B1421IL28-0A-EVB](#) [TW-DONGLE-USB](#) [EVAL-ADM2491EEBZ](#) [MAXREFDES23DB#](#) [MAX13235EEVKIT](#) [DFR0257](#) [XR22404CG28EVB](#) [ZLR964122L](#) [ZLR88822L](#) [EVK-U23-01S](#) [EVK-W262U-00](#) [DC327A](#) [PIM511](#) [PIM536](#) [PIM517](#) [DEV-17512](#) [STR-FUSB3307MPX-PPS-GEVK](#) [MAXREFDES177#](#) [EVAL-ADM2567EEBZ](#) [ZSSC3240KIT](#) [MAX9121EVKIT](#) [PIM532](#) [ZSC31010KITV2P1](#) [UMFT4233HPEV](#) [LVDS-18B-EVK](#) [XR20M1170G16-0B-EB](#) [XR20M1170G24-0B-EB](#) [XR20M1172G28-0A-EB](#) [XR20M1172G28-0B-EB](#) [SI871XSOIC8-KIT](#) [1764](#) [1833](#) [1862](#) [EVB-USB82514](#) [ATA6628-EK](#) [ATA6631-EK](#) [EVAL-CN0313-SDPZ](#) [2264](#) [MCP23X17EV](#) [PS081-EVA-HR MODULE](#) [237](#) [SMA2RJ45EVK/NOPB](#) [FR12-0002](#) [MAFR-000455-001](#)