

MAX22515 Evaluation Kit

Evaluates: MAX22515

General Description

The MAX22515 evaluation kit (EV kit) consists of the evaluation board and software. The EV kit is a fully assembled and tested circuit board that evaluates the MAX22515 IO-Link® dual-channel device transceiver.

The EV kit includes Windows®-compatible software that provides a graphical user interface (GUI) for exercising the features of the MAX22515. The EV kit is connected to a PC through a USB-A-to-micro-B cable.

Features

- IO-Link-Compliant Device Transceiver
- I/O and I²C Interface Terminals
- Arduino® Compatible Connector
- Windows 10-Compatible Software
- USB-PC Connection
- Proven PCB Layout
- Fully Assembled and Tested

Ordering Information appears at end of data sheet.

Arduino is a registered trademark of Arduino, LLC.

IO-Link is a registered trademark of Profibus User Organization (PNO).

Windows is registered trademark and registered service mark of Microsoft Corporation.

Quick Start

Recommended Equipment

- MAX22515 EV kit (USB-A-to-micro-B cable included)
- User-supplied Windows 10 PC with a spare USB port
- 24V, 1A DC power supply
- Multimeter/voltmeter

Note: In the following sections, software-related items are identified by bolding. Text in **bold** refers to items directly from the EV kit software. Text in **bold and underlined** refers to items from the Windows operating system.

Procedure

The EV kit is fully assembled and tested. Follow the steps below to verify board operation before exercising the full features of the device:

- 1) Visit www.maximintegrated.com/evkitsoftware to download the latest version of the EV kit software, MAX22513_5EVKITSetupVx.xx.ZIP. Save the EV kit software to a temporary folder and uncompress the ZIP file.
- 2) Install the EV kit software and USB driver on your computer by running the MAX22513_5EVKITSetupVx.xx.EXE program inside the temporary folder. The program files are copied to your PC and icons are created in the Windows **Start | Programs | Maxim Integrated** menu. During software installation, some versions of Windows can show a warning message indicating that this software is from an unknown publisher. This is not an error condition and it is safe to proceed with installation. Administrator privileges are required to install the USB device driver on Windows.

MAX22515 EV Kit Block Diagram

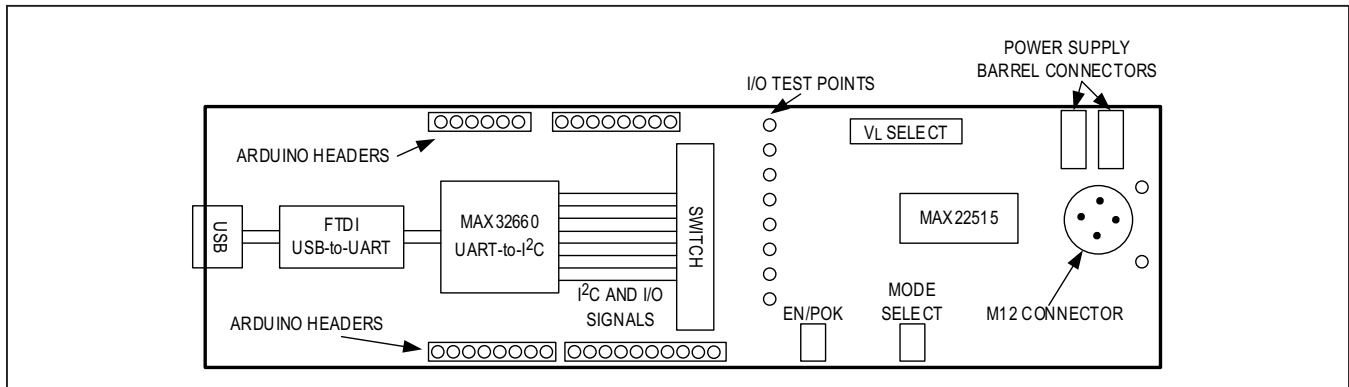

- 3) Verify that all the jumpers are in their default positions, as shown in [Table 1](#).
- 4) Connect the 24V DC power supply to the V₂₄ (TP6) and GND (TP7) barrel connectors or to the V₂₄ (TP1) and GND (TP9) test points on the EV kit board.
- 5) Connect the USB cable from the PC to the EV kit board. A Windows message appears when connecting the EV kit.
- 6) Start the EV kit software by opening its icon in the Windows **Start | Programs | Maxim Integrated** menu. The EV kit software main window appears, as shown in [Figure 1](#).
- 7) Verify that **Status: MAX32660 Connected, MAX22515 ADR = 0x68** is displayed on the status bar at the bottom left of the main window ([Figure 2](#)).
- 8) Click on the Include Interrupt Register box to include the INTERRUPT register in serial interface reads. Click on the **Read All** button to read all of the registers in the device.
- 9) Select a register in the top register table to access the bits in that register.
- 10) Set the individual bits for that register by selecting available settings from the drop-down menu for each bit in the lower register table.
- 11) Press the **Write Modified** button on the GUI to write the registers that have been changed to the MAX22515.

Detailed Description of Software

Configuring the Registers

Click on a register name in the top register table to access the individual bits in that register. When the register name is selected in the register table, the lower register table shows the individual bits for that register. Click on the drop-down menu next to each bit in the lower table to select the bit setting. When all of the bits are set as desired, click on the Write Modified button to write the changed bit settings to the MAX22515 over the I²C interface.

Note that full IO-Link communication is not available using the EV kit GUI.

I/O Pin Control

The IO-Link UART I/Os (TXEN, TX, RX, LI) and notification interrupt (WU/IRQ) can be controlled and read on the MAX22515 EV kit GUI. Click on the toggle buttons next to TXEN, TX, and LI to set these pins on the EV kit board to high (V_L) or low (GND).

When an interrupt is triggered, a bit in the INTERRUPT register is set and WU/IRQ asserts low. A yellow tag appears

in the I/O Pins box stating “Interrupt Received” ([Figure 2](#)). Read the INTERRUPT register to clear the interrupt and deassert WU/IRQ.

When a wake-up event is detected, and the WUINT is not masked in the INTERRUPT register (WUM = 0), the wake-up interrupt bit is set in the INTERRUPT register and a yellow tag appears in the I/O Pins box stating “Wak-Up Received.” WU/IRQ also asserts. Read the INTERRUPT register to clear the interrupt and deassert WU/IRQ. The green box next to WU flashes orange briefly and then turns green again.

Detailed Description of Hardware

The MAX22515 EV kit includes the MAX22515 dual-channel IO-Link transceiver and the external components for evaluating the device. The EV kit is configured for I²C operation by default. All logic-level I/Os and IO-Link capable I/Os are available on yellow test points.

Logic-Level Power Supply

The MAX22515 features an internal 3.3V linear regulator which can drive loads up to 50mA. Set V_L = 3.3V on the J6 jumper to set the logic level supply (V_L) for the I/O pins.

To use a different logic-level voltage supply, open the J6 jumper and apply the external supply to the V_L pin on the J6 jumper. *Ensure that V_L does not exceed 3.3V to protect the MAX32660.*

Selecting the Device Address

The MAX22515 includes one address pin for I²C addressing, allowing up to two devices on a single bus. Set the I²C address for the MAX22515 on the MAX22515EVKIT by setting the A0/CLKEN jumper (J8). Click the Rescan I²C Adr button after the address has been changed to reestablish I²C communication.

Using I²C Interface with an External Master Controller

The MAX22515 EV kit includes an isolated USB-to-serial interface circuit for communication with the PC/GUI, and is configured to operate with the I²C serial interface when using the on-board FTDI converter and Maxim MAX32660 microcontroller. Arduino headers are available to use the board with an external controller.

To use an external I²C controller with the MAX22515, open all the switches on SW1 (set all switches to the left) and connect the external controller to the P5, P6, P7, and P8 headers.

The screenshot shows the MAX22515 EV Kit Software interface. The 'Register Settings' tab is active, displaying a table of registers and their values. The 'MAX22513 I/O Pins' section shows the status of various pins, including TXEN, TX, RX, LO/LI, IRQ, and WU. The 'Chip Mode' is set to 'I2C config mode. UART Active'. A status bar at the bottom indicates 'MAX32660 Connected, MAX22515 ADR=0x68'.

Address	R/W	Register	Value	Description
0x00	R	INTERRUPT	0b00000000	Interrupt Register
0x01	R/W	IRQMASK	0b00000000	Interrupt Mask Register
0x02	R	STATUS	0b01000000	Status Register
0x03	R	STATUS2	0b00000001	Buck Status Register
0x04	R/W	MODE	0b00000000	Mode Register
0x05	R/W	CURRLIM	0b00000000	Current Limit Register
0x06	R/W	CONTROL	0b00000000	Control Register
0x07	R/W	CQCONFIG	0b00000001	C/Q Config Register
0x08	R/W	DOCONFIG	0b00000000	DO Config Register
0x09	R/W	CLKCONFIG	0b00000000	Clk Config Register
0x0A	R/W	CKTRIM	0b00000000	Clk Trim Register
0x0B	R/W	UNUSED	0b00000000	UNUSED
0x0C	R	CHIPID	0b00010010	Revision ID Register

Bit	Value	Name	Setting	Description
B[7]	0b0	NOTREADY	0: No Interrupt	Registers Were Reset Due to Low Voltage
B[6]	0b0	WUINT	0: No Interrupt	WakeUp Condition Detected
B[5]	0b0	DOFAULTINT	0: No Interrupt	DO Fault Detected
B[4]	0b0	CQFAULTINT	0: No Interrupt	CQ Fault Detected
B[3]	0b0	V24WINT	0: No Interrupt	V24 Below Warning Threshold Detected
B[2]	0b0	UV24INT	0: No Interrupt	V24 Below Undervoltage Theshold Detected
B[1]	0b0	THSHUTINT	0: Unused	Device Entered Thermal Shutdown
B[0]	0b0	THERMWINT	0: No Interrupt	Device Temperature Above Warning Threshold

Note: To edit the value of a R/W register, click on the Value cell.

Figure 1. MAX22515 EV Kit Software, EV Kit is Connected

The screenshot shows the 'MAX22513 I/O Pins' section of the software. The 'Read' column shows '0' for TXEN, TX, and RX, and '1' for LO/LI, IRQ, and WU. The 'Chip Mode' is 'I2C config mode. UART Active'. A yellow 'Interrupt Received' message is displayed at the bottom.

Name	Set	Function	Read	Direction
TXEN	<input type="checkbox"/>	TXEN	0	IN
TX	<input type="checkbox"/>	TX	0	IN
RX		RX	0	OUT
LO / LI		LO / LI	1	OUT
		IRQ	0	OUT
		WU	1	OUT

Chip Mode: I2C config mode. UART Active

Interrupt Received

Figure 2. MAX22515 EV Kit Software, Interrupt Received

Table 1. Jumper Descriptions

JUMPER	SHUNT POSITON	DESCRIPTION
J1	Open*	Leave this jumper open when operating the device in I ² C mode.
	1–2	SCL/100MA is high. The current limit on the C/Q driver is set to 100mA (typ).
	2–3	SCL/100MA is low. The current limit on the C/Q driver is set to 200mA (typ).
J2	Open*	MAX22515 operates in I ² C mode.
	Closed	MAX22515 operates in pin-control mode.
J3	Open*	EN/POK is pulled high. The MAX22515 is enabled.
	Closed	EN/POK is pulled low. The MAX22515 is disabled.
J4	1–2	LIN is connected to V ₅ . Apply an external voltage to the V ₅ pin on the J6 header for normal operation.
	2–3*	LIN is connected to V ₂₄ .
J6	1–2	V _L is connected to V ₅ (V _L = 5V).
	2–3*	V _L is connected to V ₃₃ (V _L = 3.3V).
J8	1–2	A0/CLKEN is high.
	2–3*	A0/CLKEN is low.
J10	1–2*	TXEN is high.
	2–3*	TXEN is low.
J15	Open*	Do not use.
J16	1–2	MCLK is connected to the 32KIN input of the MAX32660.
	2–3*	Output of the on-board oscillator is connected to the 32KIN input of the MAX32660

*Default position.

Ordering Information

PART	TYPE
MAX22515EVKIT#	EV Kit

#Denotes a RoHS-compliant device that may include lead that is exempt under the RoHS requirements.

MAX22515 EV Kit Bill of Materials

ITEM	REF_DES	DNI/DNP	QTY	MFG PART #	MANUFACTURER	VALUE	DESCRIPTION
1	C1, C3	-	2	CGA3EANP02A103J080AC	TDK	0.01UF	CAPACITOR; SMT (0603); CERAMIC CHIP; 0.01UF; 100V; TOL=5%; MODEL=MULTILAYER CERAMIC CHIP CAPACITOR; TC=NPO
2	C2, C8	-	2	CL05B105KQ5NQNC; GRM155R70J105KA12	SAMSUNG ELECTRONICS; MURATA	1UF	CAPACITOR; SMT (0402); CERAMIC CHIP; 1UF; 6.3V; TOL=10%; TG=-55 DEGC TO +125 DEGC; TC=X7R
3	C5	-	1	C0402C104J4RAC; GCM155R71C104JA55	KEMET;MURATA	0.1UF	CAPACITOR; SMT (0402); CERAMIC CHIP; 0.1UF; 16V; TOL=5%; MODEL=; TG=-55 DEGC TO +125 DEGC; TC=X7R
4	C6, C7, C10, C11	-	4	C0402X7R500-331KNE; GRM155R71H331KA01; ECJ-0EB1H331K	VENKEL LTD;MURATA; PANASONIC	330PF	CAPACITOR; SMT (0402); CERAMIC CHIP; 330PF; 50V; TOL=10%; TG=-55 DEGC TO +125 DEGC; TC=X7R
5	C14	-	1	C0603C105K4RAC; GRM188R71C105KA12; C1608X7R1C105K080AC; EMK107B7105KA; GCM188R71C105KA64; CGA3E1X7R1C105K080AC	KEMET;MURATA;TDK; TAIYO YUDEN;MURATA; TDK	1UF	CAPACITOR; SMT (0603); CERAMIC CHIP; 1UF; 16V; TOL=10%; MODEL=; TG=-55 DEGC TO +125 DEGC; TC=X7R
6	C15	-	1	KTS250B336M55N0T00	NIPPON CHEMI-CON	33UF	CAPACITOR; SMT (2220); CERAMIC; 33UF; 25V; TOL=20%; MODEL=X7R; TG=-55 DEGC TO +125 DEGC; TC=+/-
7	C16	-	1	GRM15XR71C332KA86	MURATA	3300PF	CAPACITOR; SMT (0402); CERAMIC CHIP; 3300PF; 16V; TOL=10%; TG=-55 DEGC TO +125 DEGC; TC=X7R
8	C17	-	1	EMK107B7105MA	TAIYO YUDEN	1UF	CAPACITOR; SMT (0603); CERAMIC CHIP; 1UF; 16V; TOL=20%; MODEL=M SERIES; TG=-55 DEGC TO +125 DEGC; TC=X7R
9	C18	-	1	GRM21BR61A106KE19; ECJ-2FB1A106; CL21A106KPLQNC; GRM219R61A106KE44	MURATA;PANASONIC; SAMSUNG ELECTRONICS; MURATA	10UF	CAPACITOR; SMT (0805); CERAMIC CHIP; 10UF; 10V; TOL=10%; MODEL=; TG=-55 DEGC TO +85 DEGC; TC=X5R
10	C19	-	1	C0603X7R1A103K030BA; GRM033R71A103KA01; GCM033R71A103KA03; CGA1A2X7R1A103K030BA; 0201ZC103KAT2A	TDK;MURATA;MURATA; TDK;AVX	0.01UF	CAPACITOR; SMT (0201); CERAMIC CHIP; 0.01UF; 10V; TOL=10%; TG=-55 DEGC TO +125 DEGC; TC=X7R
11	C20	-	1	GRM188F51A475Z	MURATA	4.7UF	CAPACITOR; SMT (0603); CERAMIC CHIP; 4.7UF; 10V; TOL=+80%-20%; MODEL=GRM SERIES; TG=-30 DEGC TO +85 DEGC; TC=Y5V
12	C21	-	1	GRM033R61A104KE15; LMK063BJ104KP	MURATA;TAIYO YUDEN	0.1UF	CAPACITOR; SMT (0201); CERAMIC CHIP; 0.1UF; 10V; TOL=10%; MODEL=; TG=-55 DEGC TO +125 DEGC; TC=X5R
13	C22, C23	-	2	GRM0335C1E470JA01	MURATA	47PF	CAPACITOR; SMT (0201); CERAMIC CHIP; 47PF; 25V; TOL=5%; TG=-55 DEGC TO +125 DEGC; TC=COG
14	C24	-	1	C0201C104K9PAC; GRM033R60J104KE19; C0603X5R0J104K030BC; C0201X5R6R3-104KNP	KEMET;MURATA; VENKEL;TDK	0.1UF	CAPACITOR; SMT (0201); CERAMIC CHIP; 0.1UF; 6.3V; TOL=10%; MODEL=X5R; TG=-25 DEGC TO +85 DEGC; TC=+/-
15	C26, C27	-	2	C0402C105K8PAC; CC0402KRX5R6BB105	KEMET;YAGEO	1UF	CAPACITOR; SMT (0402); CERAMIC CHIP; 1UF; 10V; TOL=10%; TG=-55 DEGC TO +85 DEGC; TC=X5R
16	J1, J4, J6, J8, J10, J16	-	6	TSW-103-07-T-S	SAMTEC	TSW-103-07-T-S	CONNECTOR; THROUGH HOLE; TSW SERIES; SINGLE ROW; STRAIGHT; 3PINS
17	J2, J3	-	2	TSW-102-07-T-S	SAMTEC	TSW-102-07-T-S	CONNECTOR; THROUGH HOLE; TSW SERIES; SINGLE ROW; STRAIGHT; 2PINS; -55 DEGC TO +105 DEGC
18	J7	-	1	09 0431 212 04	BINDER	09 0431 212 04	CONNECTOR; MALE; TH; MALE RECEPTACLE; THREADED; PCB SOLDER; STRAIGHT; 4PINS;
19	J9	-	1	ZX62D-AB-5P8	HIROSE ELECTRIC CO LTD.	ZX62D-AB-5P8	CONNECTOR; FEMALE; SMT; USB MICRO CONNECTOR; RIGHT ANGLE; 5PINS
20	J15	-	1	FTSH-105-01-L-DV-K	SAMTEC	FTSH-105-01-L-DV-K	CONNECTOR; MALE; SMT; 0.05 (1.27MM) SMT MICRO HEADER; STRAIGHT; 10PINS

MAX22515 EV Kit Bill of Materials (Continued)

ITEM	REF_DES	DNI/DNP	QTY	MFG PART #	MANUFACTURER	VALUE	DESCRIPTION
21	L2	-	1	LPS6235-333MR	COILCRAFT	33UH	INDUCTOR; SMT; MAGNETICALLY SHIELDED; 33UH; TOL=+/-20%; 1.3A
22	L3	-	1	BLM21AG601SN1	MURATA	600	INDUCTOR; SMT (0805); FERRITE-BEAD; 600; TOL=+/-25%; 0.2A
23	MISC1	-	1	68784-0001	MOLEX	68784-0001	CONNECTOR; MALE; USB; USB A PLUG TO MICRO B PLUG CABLE ASSY; STRAIGHT; 4PINS-5PINS
24	R1-R3, R7, R9, R21, R24	-	7	CRCW040210K0FK; RC0402FR-0710KL	VISHAY DALE; YAGEO PHICOMP	10K	RESISTOR; 0402; 10K; 1%; 100PPM; 0.0625W; THICK FILM
25	R8	-	1	CRCW0402100RFK; 9C04021A1000FL; RC0402FR-07100RL	VISHAY DALE; PANASONIC; YAGEO PHYCOMP	100	RESISTOR; 0402; 100 OHM; 1%; 100PPM; 0.063W; THICK FILM
26	R22	-	1	CRCW0603499RFK; RK73H1J4990FT; ERJ-3EKF4990; RC1608F4990	KOA; VISHAY; PANASONIC; SAMSUNG	499	RESISTOR; 0603; 499 OHM; 1%; 100PPM; 0.10W; THICK FILM
27	R25, R28, R30, R31, R34, R36-R40	-	10	ERJ-2RKF2200	PANASONIC	220	RESISTOR; 0402; 220 OHM; 1%; 100PPM; 0.1W; THICK FILM
28	R26, R27	-	2	CRCW040210R0FK; 9C04021A10R0FL	VISHAY DALE; YAGEO	10	RESISTOR; 0402; 10 OHM; 1%; 100PPM; 0.0625W; THICK FILM
29	R32, R33	-	2	ERJ-1GNF27R0	PANASONIC	27	RESISTOR; 0201; 27 OHM; 1%; 200PPM; 0.05W; THICK FILM
30	R41, R42	-	2	CRCW04021K00FK; RC0402FR-071KL; MCR01MZPF1001	VISHAY DALE; YAGEO PHICOMP; ROHM SEMI	1K	RESISTOR; 0402; 1K; 1%; 100PPM; 0.0625W; THICK FILM
31	SU1-SU8	-	8	25N-BK-G	SAMTEC	25N-BK-G	TEST POINT; JUMPER; STR; TOTAL LENGTH=0.175IN; BLACK; INSULATION=PBT; PHOSPHOR BRONZE CONTACT=GOLD PLATED
32	SW1	-	1	219-10MST	CTS	219-10MST	SWITCH; SPST; SMT; STRAIGHT; 20V; 0.1A; SURFACE MOUNT DIP SWITCH-AUTO PLACEABLE; RINSULATION=1000M OHM
33	TP1	-	1	5010	KEystone	N/A	TEST POINT; PIN DIA=0.125IN; TOTAL LENGTH=0.445IN; BOARD HOLE=0.063IN; RED; PHOSPHOR BRONZE WIRE SIL;
34	TP6	-	1	571-0500	DELTRON	571-0500	CONNECTOR; FEMALE; THROUGH HOLE; BANANA 4MM SOCKET; RIGHT ANGLE; 2PINS
35	TP7	-	1	571-0100	DELTRON	571-0100	CONNECTOR; FEMALE; THROUGH HOLE; BANANA 4MM SOCKET; RIGHT ANGLE; 2PINS
36	TP9-TP11	-	3	5011	KEystone	N/A	TEST POINT; PIN DIA=0.125IN; TOTAL LENGTH=0.445IN; BOARD HOLE=0.063IN; BLACK; PHOSPHOR BRONZE WIRE SILVER PLATE FINISH;
37	TP13-TP19, TP21, TP23	-	9	5014	KEystone	N/A	TEST POINT; PIN DIA=0.125IN; TOTAL LENGTH=0.445IN; BOARD HOLE=0.063IN; YELLOW; PHOSPHOR BRONZE WIRE SILVER PLATE FINISH;
38	U1	-	1	MAX22515ATG+	MAXIM	MAX22515ATG+	EVKIT PART - IC; MAX22515ATG+; IO-LINK TRANSCEIVER WITH INTEGRATED PROTECTION; TQFN24-EP 4X4; PACKAGE OUTLINE DRAWING: 21-0139; LAND PATTERN NUMBER: 90-0022; PACKAGE CODE: T2444+4
39	U2	-	1	MAX17501EATB+	MAXIM	MAX17501EATB+	IC; CONV; ULTRA-SMALL; HIGH-EFFICIENCY; SYNCHRONOUS STEP-DOWN DC-DC CONVERTER; TDFN10-EP
40	U3	-	1	ECS-.327-6-12	ECS INC	32.768KHZ	CRYSTAL; SMT 2.0 MM X 1.2 MM; 6PF; 32.768KHZ; +/-20PPM; -0.03PPM/DEGC2
41	U4	-	1	MAX32660GTP+	MAXIM	MAX32660GTP+	IC; UCON; ULTRA-LOW POWER ARM CORTEX-M4 WITH FPU-BASED MICROCONTROLLER FOR WEARABLE AND IOT SENSORS; TQFN20-EP
42	U6	-	1	FT234XD	FUTURE TECHNOLOGY DEVICES INTL LTD	FT234XD	IC; INFC; USB TO BASIC UART; DFN12-EP
43	PCB	-	1	MAX22515	MAXIM	PCB	PCB:MAX22515
44	U5	DNP	0	ARDUINO_UNO_R3	ARDUINO	ARDUINO_UNO_R3	MODULE; ARDUINO_UNO_R3
45	VR1	DNP	0	VC060326A580DP	AVX	VC060326A580DP	VARISTOR; TVS; SMT (0603); VB=34.5V; IP=30A
TOTAL			91				

MAX22515 EV Kit Schematic

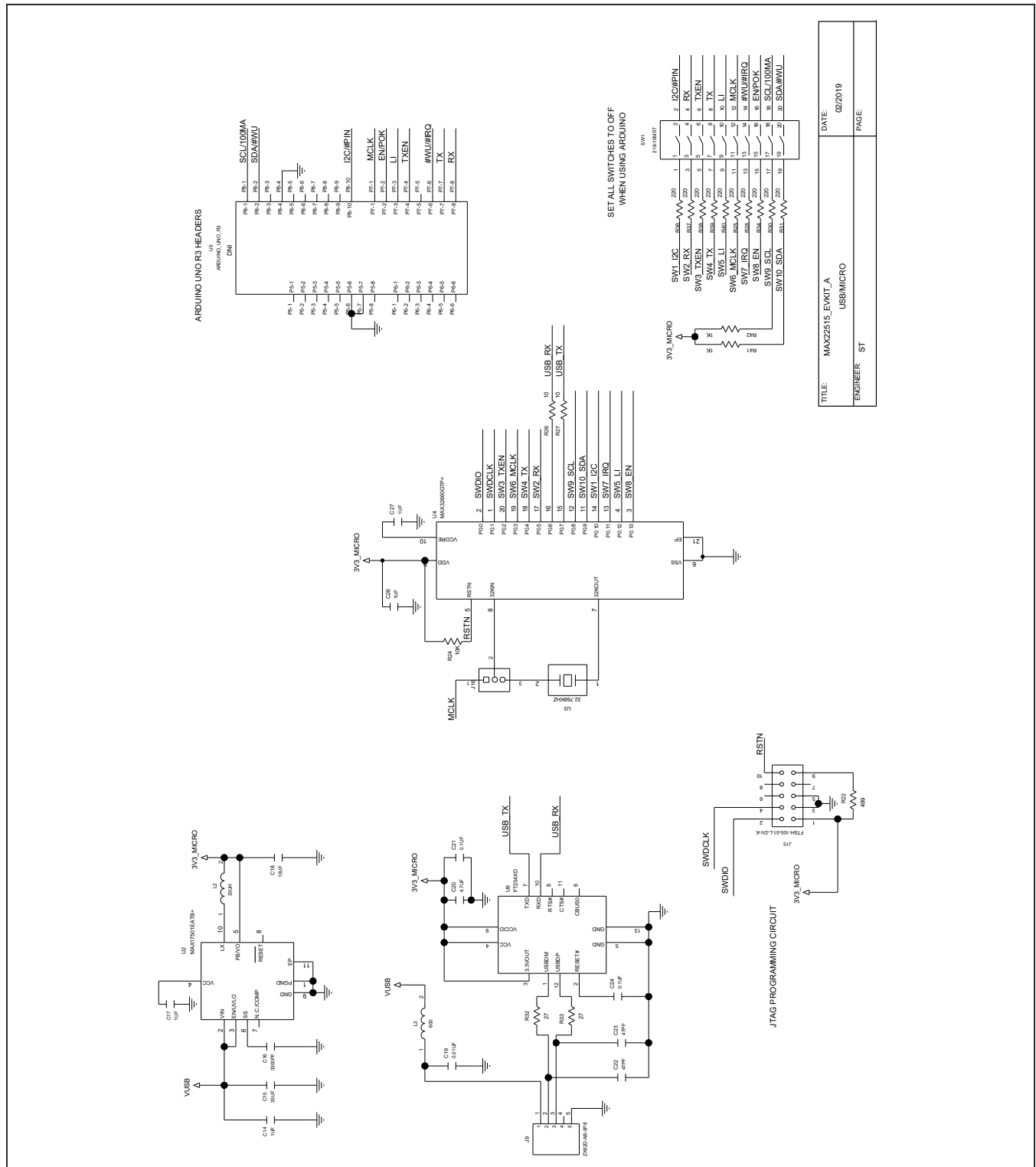

MAX22515 EV Kit Schematic (continued)

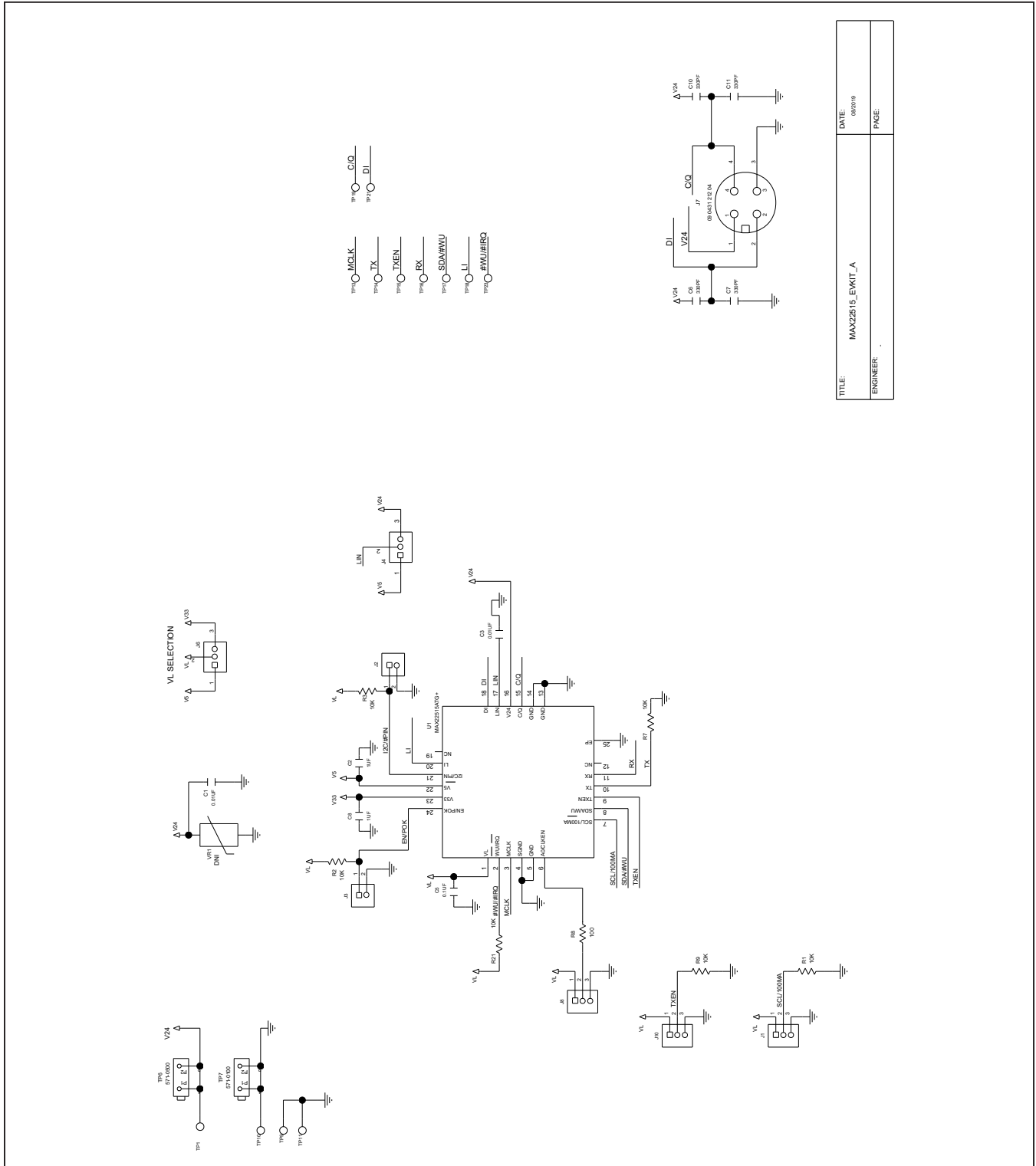

TITLE:	MAX22515_EVKIT_A
ENGINEER:	
DATE:	08/2010
PAGE:	

MAX22515 EV Kit PCB Layout Diagrams

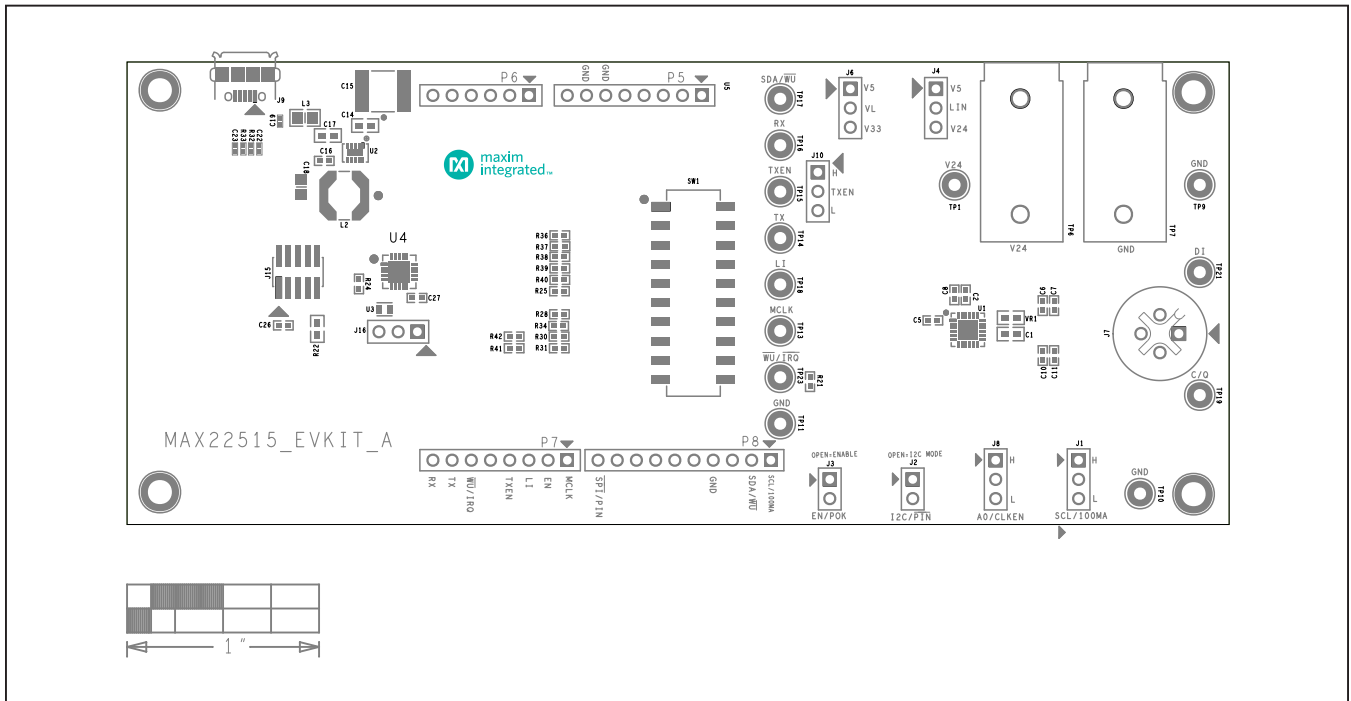

MAX22515 EV Kit PCB Layout—Top Silkscreen

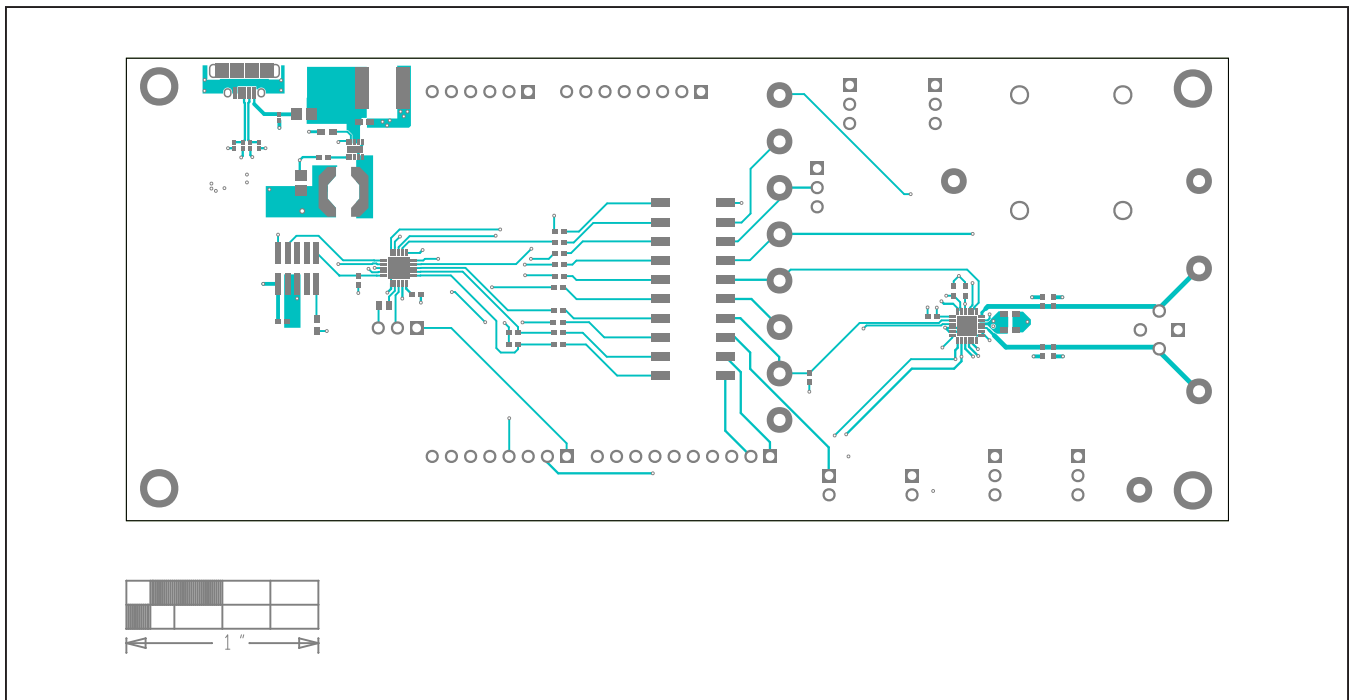

MAX22515 EV Kit PCB Layout—Top Layer

MAX22515 EV Kit PCB Layout Diagrams (continued)

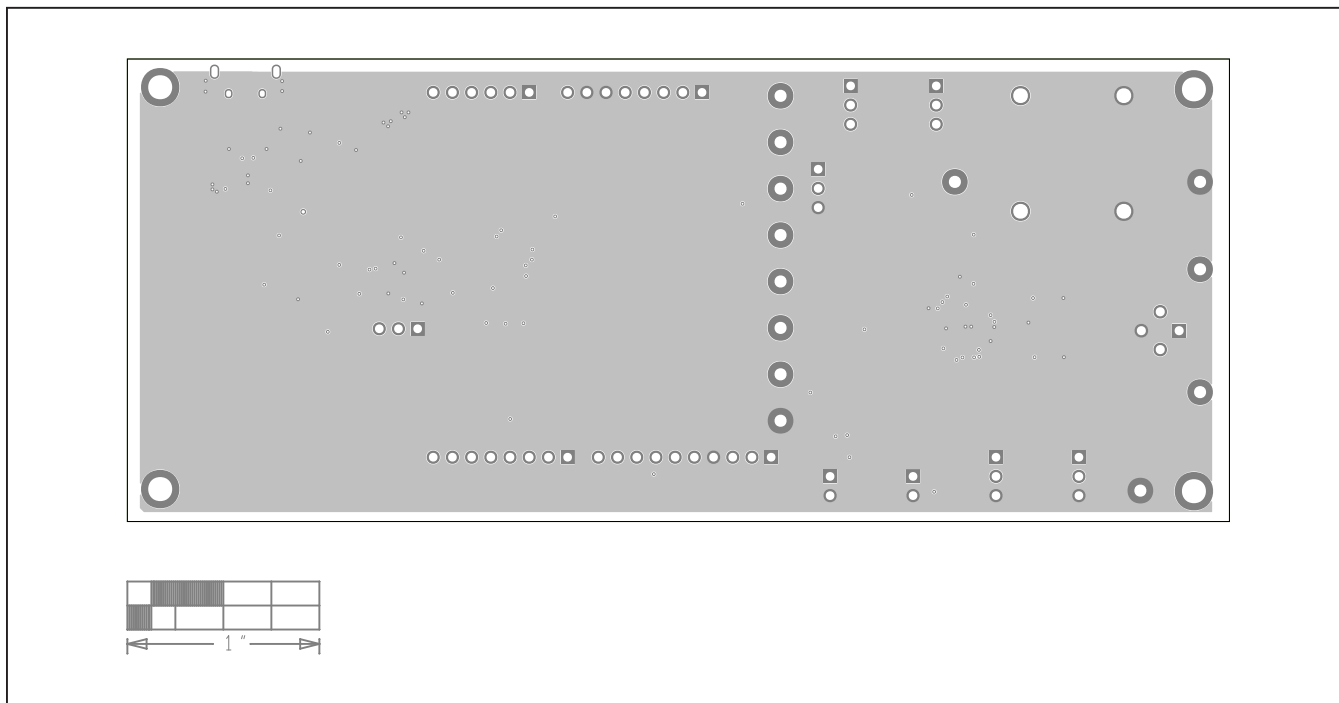

MAX22515 EV Kit—Internal 2

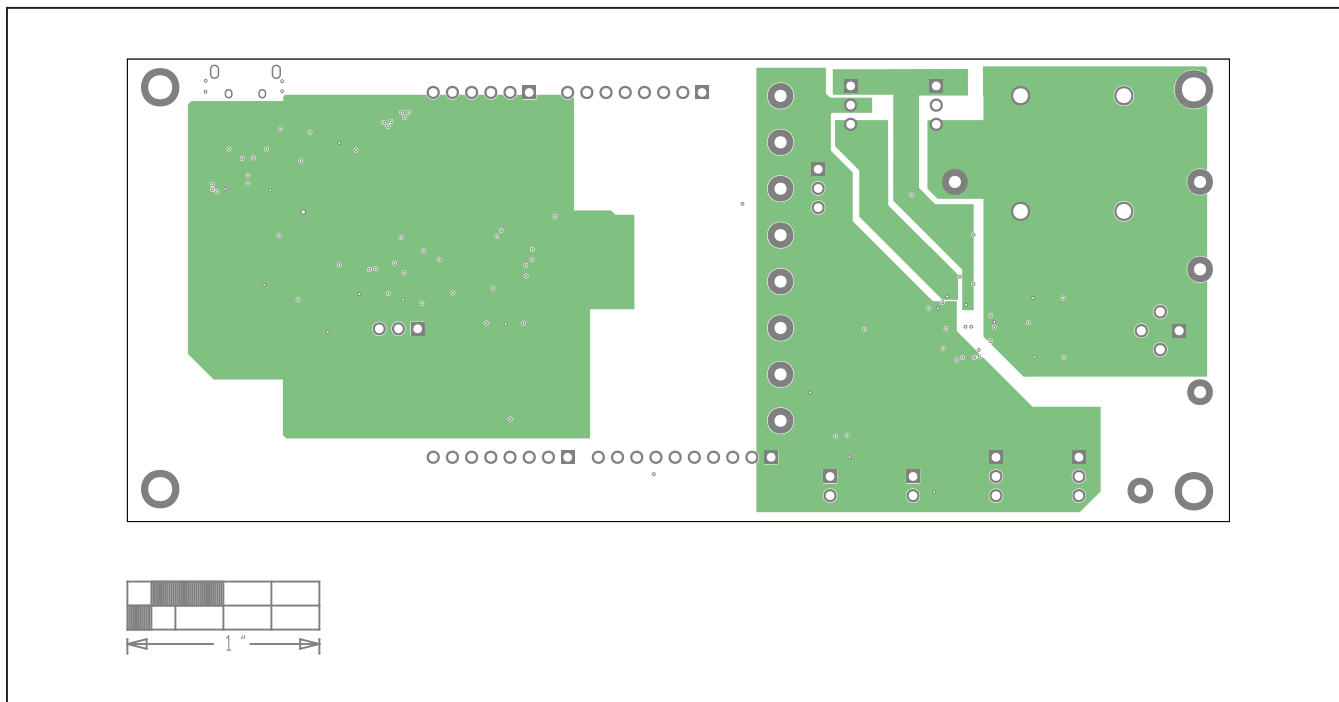

MAX22515 EV Kit—Internal 3

MAX22515 EV Kit PCB Layout Diagrams (continued)

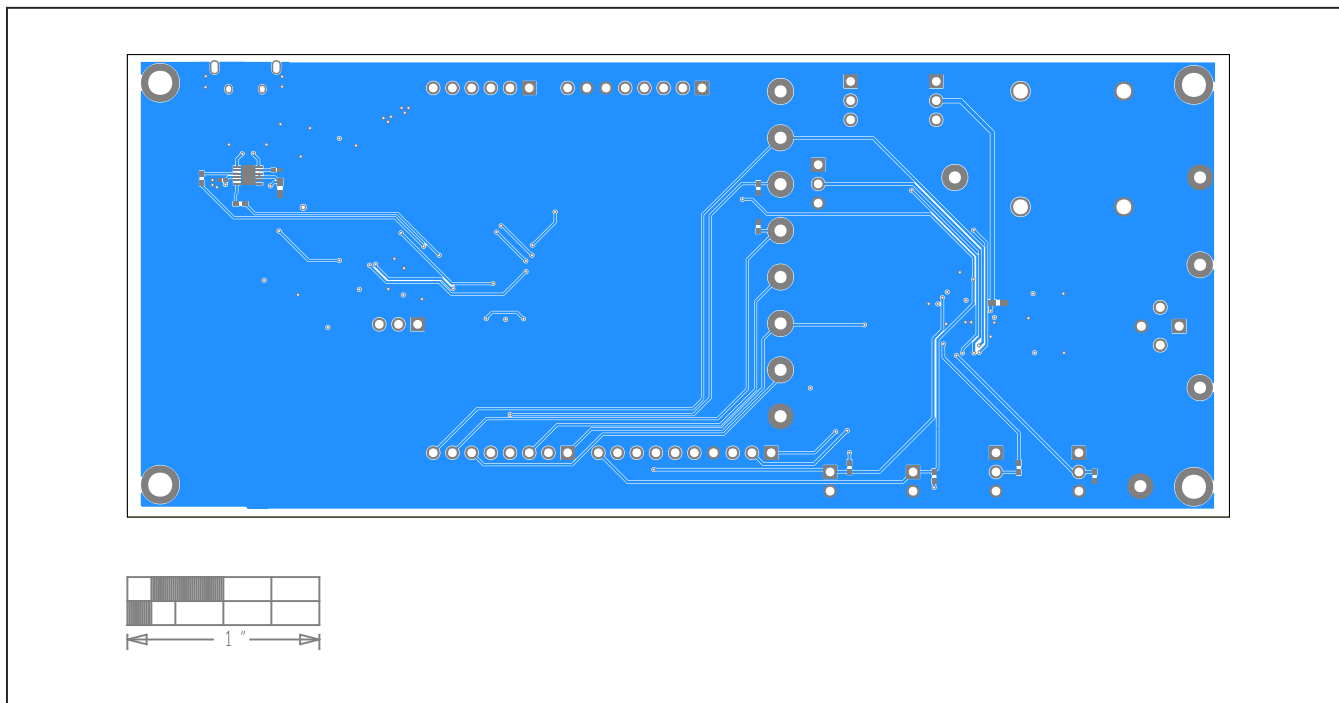

MAX22515 EV Kit—Bottom Layer

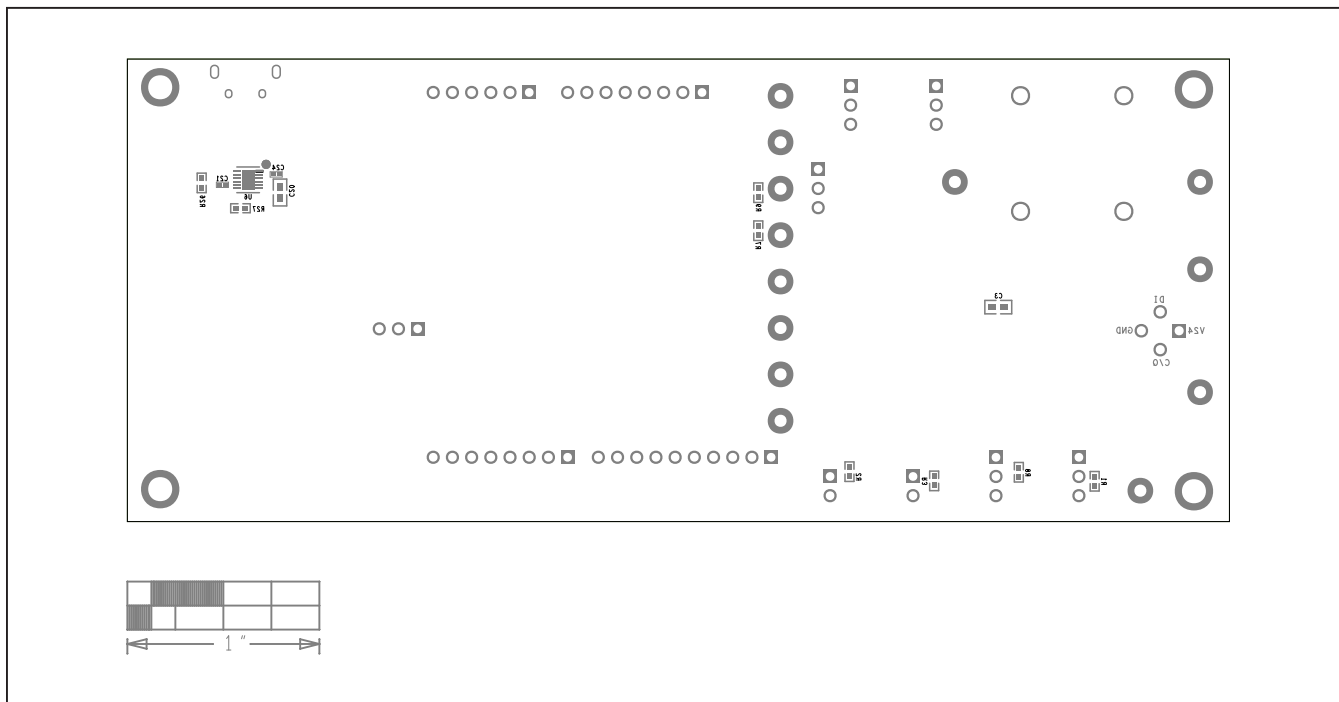

MAX22515 EV Kit—Bottom Silkscreen

Revision History

REVISION NUMBER	REVISION DATE	DESCRIPTION	PAGES CHANGED
0	10/19	Initial release	—

For pricing, delivery, and ordering information, please visit Maxim Integrated's online storefront at <https://www.maximintegrated.com/en/storefront/storefront.html>.

Maxim Integrated cannot assume responsibility for use of any circuitry other than circuitry entirely embodied in a Maxim Integrated product. No circuit patent licenses are implied. Maxim Integrated reserves the right to change the circuitry and specifications without notice at any time.

X-ON Electronics

Largest Supplier of Electrical and Electronic Components

Click to view similar products for [Interface Development Tools](#) category:

Click to view products by [Maxim](#) manufacturer:

Other Similar products are found below :

[ADP5585CP-EVALZ](#) [CHA2066-99F](#) [AS8650-DB](#) [MLX80104 TESTINTERFACE](#) [416100120-3](#) [XR18910ILEVB](#) [XR21B1421IL28-0A-EVB](#) [TW-DONGLE-USB](#) [EVAL-ADM2491EEBZ](#) [MAXREFDES23DB#](#) [MAX13235EEVKIT](#) [DFR0257](#) [XR22404CG28EVB](#) [ZLR964122L](#) [ZLR88822L](#) [EVK-U23-01S](#) [EVK-W262U-00](#) [DC327A](#) [PIM511](#) [PIM536](#) [PIM517](#) [DEV-17512](#) [STR-FUSB3307MPX-PPS-GEVK](#) [MAXREFDES177#](#) [EVAL-ADM2567EEBZ](#) [ZSSC3240KIT](#) [MAX9121EVKIT](#) [PIM532](#) [ZSC31010KITV2P1](#) [UMFT4233HPEV](#) [LVDS-18B-EVK](#) [XR20M1170G16-0A-EB](#) [XR20M1170G16-0B-EB](#) [XR20M1170G24-0B-EB](#) [XR20M1172G28-0A-EB](#) [XR20M1172G28-0B-EB](#) [SI871XSOIC8-KIT](#) [1764](#) [1833](#) [1862](#) [EVB-USB82514](#) [ATA6628-EK](#) [ATA6631-EK](#) [EVAL-CN0313-SDPZ](#) [2264](#) [MCP23X17EV](#) [PS081-EVA-HR MODULE](#) [237](#) [SMA2RJ45EVK/NOPB](#) [FR12-0002](#)